

AC Line Rated Ceramic Disc Capacitors

Class X1, 760 V_{AC}, Class Y1, 500 V_{AC}

FEATURES

- Complying with IEC 60384-14 4th edition
- Can pass 10 kV pulses (10 per polarity)
- Withstands 85 / 85 / 1000 h test
- Reduced size (compact design)
- High reliability
- Vertical (inline) kinked or straight leads
- Singlelayer AC disc safety capacitors
- Material categorization:
for definitions of compliance please see www.vishay.com/doc?99912

ADDITIONAL RESOURCES

APPLICATIONS

- X1, Y1 according to IEC 60384-14.4
- Across-the-line
- Line by-pass
- Antenna coupling

DESIGN

The capacitor consists of a ceramic disc which is copper plated on both sides. Connection leads are made of tinned copper clad steel having a diameter of 0.6 mm.

The capacitors may be supplied with vertical (inline) kinked leads having a lead spacing of 10.0 mm, or 12.5 mm. Encapsulation is made of flame retardant epoxy resin in accordance with UL 94 V-0.

CAPACITANCE RANGE

470 pF to 4700 pF

RATED VOLTAGE U_R

IEC 60384-14.4:

(X1): 760 V_{AC}, 50 Hz

(Y1): 500 V_{AC}, 50 Hz

1500 V_{DC}

TEST VOLTAGE

Component test (100 %):

4000 V_{AC}, 50 Hz, 2 s

Random sampling test (destructive test):

4000 V_{AC}, 50 Hz, 60 s

Voltage proof of coating (destructive test):

4000 V_{AC}, 50 Hz, 60 s

INSULATION RESISTANCE

≥ 10 000 MΩ

CAPACITANCE TOLERANCE

± 20 %

DISSIPATION FACTOR

Max. 2.5 % (1 kHz)

QUICK REFERENCE DATA	
DESCRIPTION	VALUE
Ceramic Class	2
Ceramic Dielectric	Y5U Y5U
Voltage (V _{AC})	500 760
Min. Capacitance (pF)	470
Max. Capacitance (pF)	4700
Mounting	Radial

OPERATING TEMPERATURE RANGE

-40 °C to +125 °C

TEMPERATURE CHARACTERISTICS

Y5U

SECTIONAL SPECIFICATIONS

Climatic category (according to EN 60058-1)

40/125/21

COATING

According to UL 94 V-0

Epoxy resin, isolating, flame retardant

Halogen-free

Reinforced insulation

APPROVALS

IEC 60384-14.4

UL 60384-14

DIN EN 60384-14

CSA E60384-1:03, CSA E60384-14:09

CQC11-471112-2009

PACKAGING

Bulk, tape and reel, taped ammpack



DIMENSIONS in millimeters

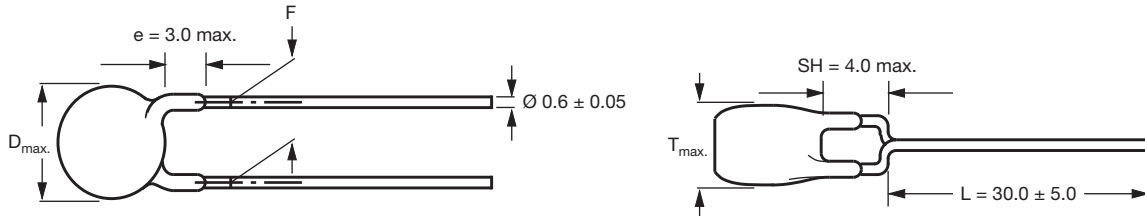

Capacitors with 10.0 mm or 12.5 mm lead spacing

TECHNICAL DATA

CAPACITANCE C (pF)	CAPACITANCE TOLERANCE (%)	BODY DIAMETER D _{max.} (mm)	BODY THICKNESS T _{max.} (mm)	LEAD SPACING F (mm) ± 1 mm	PART NUMBER
					MISSING DIGITS SEE ORDERING CODE BELOW
470	± 20	7.5	5.0	10.0 or 12.5	VY1471M29Y5UC6###
680					VY1681M29Y5UC6###
1000		8.0			VY1102M31Y5UC6###
1500		9.0			VY1152M35Y5UC6###
2200		11.0			VY1222M43Y5UC6###
2700		12.0			VY1272M47Y5UC6###
3300		13.0			VY1332M51Y5UC6###
3900		15.0			VY1392M59Y5UC6###
4700		15.5			VY1472M61Y5UC6###

Notes

- Straight leads available on request
- Coating extension DR valid for straight leads only

ORDERING CODE

#	7 th digit	Capacitance tolerance				± 20 % = M				
###	15 th to 17 th digit	Lead configuration	Available configurations see below							
Example	VY1	471	M	29	Y5U	C	6	T	V	0
	Series	Capacitance value	Tolerance code	Size code	Temperature coefficient	Rated voltage	Lead wire diameter	Packaging / lead length	Lead style	Lead spacing
						Compact size		3 = bulk T = tape and reel U = ammpack	L = straight V = inline kinked	0 = 10.0 X = 12.5

PACKAGING					
CAPACITANCE VALUE	SIZE CODE	BODY DIAMETER $D_{max.}$ (mm)	PACKAGING QUANTITIES		
			BULK	REEL	AMMO
470 pF to 2700 pF	29 to 47	12.0	1000	500	750
3300 pF to 4700 pF	51 to 61	15.5	500	500	750

Note

- The capacitors are supplied in bulk packaging (cardboard boxes), in tape on reel or in ammpack

STRAIGHT LEADS

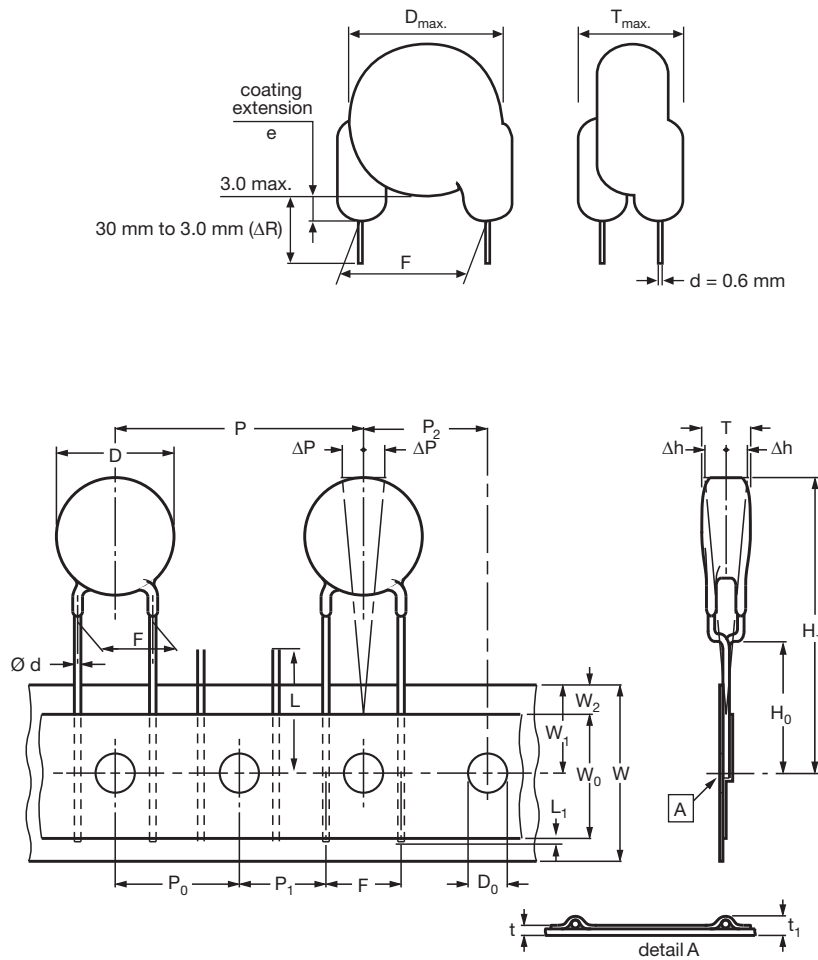

The sprocket hole pitch (P_0) is 12.7 mm for lead spacing 10.0 mm and 12.5 mm

DIMENSIONS OF TAPE		
SYMBOL	PARAMETER	DIMENSIONS (mm)
D ⁽¹⁾	Body diameter	16.0 max.
d	Lead diameter	0.6 ± 0.05
P	Pitch of component	25.4 ± 1
P ₀ ⁽²⁾	Pitch of sprocket hole	12.7 ± 0.3
P ₁ ⁽³⁾	Distance, hole center to lead	7.7 or 6.4 ± 1.0
P ₂ ⁽³⁾	Distance, hole to center of component	12.7 ± 1.5
F	Lead spacing	10.0 or 12.5 + 0.6/- 0.4
Δh	Average deviation across tape	± 1.0 max.
ΔP	Average deviation in direction of reeling	± 1.0 max.
W	Carrier tape width	18.0 + 1/- 0.5
W ₀	Hold-down tape width	5.0 min.
W ₁	Position of sprocket hole	9.0 + 0.75/- 0.5
W ₂	Distance of hold-down tape	3.0 max.
H ₁	Maximum component height	40.0
H ₀	Height to seating plane (for kinked leads)	16.0 ± 0.5
H ₀	Height to seating plane (for straight leads)	20.0 ± 0.5
L	Length of cut leads	11.0 max.
L ₁	Length of lead protrusion	1.0 max.
D ₀	Diameter of sprocket hole	4.0 ± 0.2
t	Total tape thickness	0.9 max.
t ₁	Total tape thickness with lead wire	t + d

Notes

- (1) See "Technical Data" table
- (2) Cumulative pitch error: ± 1 mm/20 pitches
- (3) Obliquity maximum 3°

REEL AND TAPE DATA in millimeters



Reel with capacitors on tape



Ammopack with capacitors on tape



APPROVALS

IEC 60384-14.4 - Safety tests
This approval together with CB test certificate substitutes all national approvals.

CB Certificate

Y1-capacitor: CB test certificate:	US-26561-UL	470 pF to 4.7 nF	500 V _{AC}
X1-capacitor: CB test certificate:	US-26561-UL	470 pF to 4.7 nF	760 V _{AC}



VDE

Y1-capacitor: VDE marks approval:	40012673	470 pF to 4.7 nF	500 V _{AC}
X1-capacitor: VDE marks approval:	40012673	470 pF to 4.7 nF	760 V _{AC}



DIN EN 60384-14 VDE 0565-1-1:2006-04 - Safety tests

Underwriters Laboratories Inc./Canadian Standards Association

Y1-capacitor: CSA test certificate:	E183844	470 pF to 4.7 nF	500 V _{AC}
X1-capacitor: CSA test certificate:	E183844	470 pF to 4.7 nF	760 V _{AC}



UL 60384-14, CSA E60384-1:03, CSA E60384-14:09

Fixed capacitors for electromagnetic interference suppression and connection to the supply mains.

CQC

Y1-capacitor: CQC test certificate:	CQC05001015032	470 pF to 4.7 nF	500 V _{AC}
X1-capacitor: CQC test certificate:	CQC05001015032	470 pF to 4.7 nF	760 V _{AC}



MARKING

Sample
(2 sides)

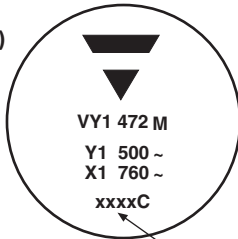

4 digit date code
(year / week)

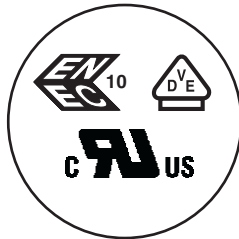

PN: VY1472M61Y5UC63V0	Lot1: 1401444M08	DC1: 1451
QTY: 500	Lot2:	DC2:
PO: /	Batch: 201451CN	
SO:	Region: 9520	SL: 0010
	Ser.No: 1451M09589	

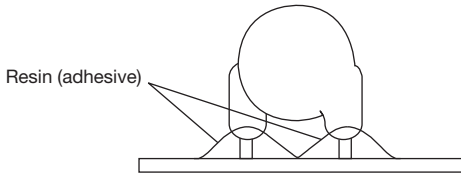

1/1

PERFORMANCE		
TEST	TEST CONDITION	TEST LIMITS
Visual and mechanical inspection	Optical inspection, dimensions measured with caliper	No visible damage, marking legible
Capacitance (C)	25 °C ± 3 °C , relative humidity (RH) ≤ 75 % ,	Capacitance within specified tolerance
Dissipation factor (DF)	1.0 V _{RMS} ± 0.2 V _{RMS} at 1 kHz	DF ≤ 2.5 %
Insulation resistance (IR)	Measured within 60 s ± 5 s after charging at 500 V _{DC}	10 000 MΩ min.
Dielectric strength	4000 V _{AC} at 50 Hz/60 Hz for 1 min, 50 mA max.	No failure
Temperature characteristic	RH ≤ 75 % , 1.0 V _{RMS} ± 0.2 V _{RMS} at 1 kHz	+22 % / -56 %
Impulse voltage	Pulse voltage: 10 kV Pulses per polarity: 10 Polarity: ± (both) Time between pulses of same polarity: 20 s Time between pulses of different polarity: 30 s	No failure
Life test	1000 h at 125 °C ± 2 °C , 850 V _{AC} / 50 Hz; once every hour 1000 V _{AC} for 0.1 s	External appearance: no visible damage ΔC/C ≤ ± 15 % DF ≤ 5 % IR ≥ 3000 MΩ Dielectric strength: no failure
Damp heat test (85 / 85 / 1000 h)	1000 h + 48 h / - 0 h at 85 % relative humidity, 85 °C ± 3 °C , loading voltage: 760 V _{AC}	No failure
Humidity test	500 h at 500 V _{AC} , 50 Hz and 500 h unloaded 40 °C, RH = 90 % to 95%	External appearance: no visible damage ΔC/C ≤ ± 15 % DF ≤ 5 % IR ≥ 3000 MΩ Dielectric strength: no failure
Robustness of termination	Pull test: 0.5 kg tensile weight in radial direction for 10 s ± 1 s Bending strength: capacitor body rotated by 90° in both directions	No damage to capacitor body and lead wire
Soldering effect	Immersion of lead wires into 260 °C ± 5 °C solder for 10 s ± 2 s ; min. distance from body: 1.5 mm Hand soldering at 400 °C ± 10 °C for 3 s to 4 s ; min. distance from body: 1.5 mm	External appearance: no visible damage ΔC/C ≤ ± 10 % Dielectric strength: no failure
Vibration test	 <p>Solder the capacitor onto test jig (glass epoxy body) and use resin (adhesive) to stick the body to the test jig. The capacitor must be soldered firmly to the supporting lead wire. Vibration change from 10 Hz to 2000 Hz and back to 10 Hz; Total amplitude: 1.5 mm; Acceleration: 100 m/s²; Sweep rate: 1 oct/min, each axis 2 h (6 h in total)</p>	External appearance: no visible damage Capacitance within specified tolerance DF ≤ 2.5 % IR ≥ 10 000 GΩ



LEAKAGE CURRENT VS. VOLTAGE (Typical)

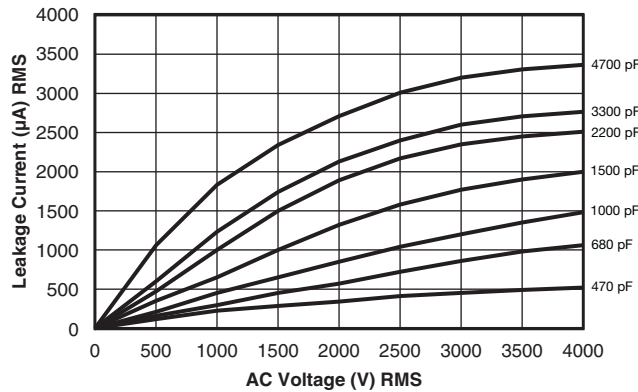

IMPEDANCE VS. FREQUENCY (Typical)

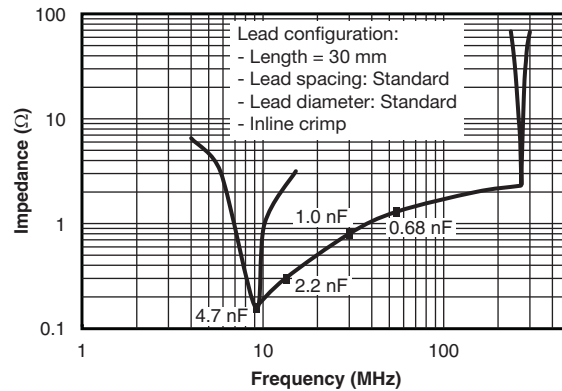

Note

- The capacitors meet the essential requirements of "EIA 198". Unless stated otherwise all electrical values apply at an ambient temperature of 25 °C ± 3 °C, at normal atmospheric conditions

RELATED DOCUMENTS	
General Information	www.vishay.com/doc?28536
CB Test Certificate	www.vishay.com/doc?22249
VDE Marks Approval	www.vishay.com/doc?22251
UL Test Certificate	www.vishay.com/doc?22250
CQC Test Certificate	www.vishay.com/doc?22248
LTspice® Models	www.vishay.com/doc?28568

SAMPLE KIT	
Part Number	VY11-KIT-CS
Link	www.vishay.com/doc?28556



Disclaimer

ALL PRODUCT, PRODUCT SPECIFICATIONS AND DATA ARE SUBJECT TO CHANGE WITHOUT NOTICE TO IMPROVE RELIABILITY, FUNCTION OR DESIGN OR OTHERWISE.

Vishay Intertechnology, Inc., its affiliates, agents, and employees, and all persons acting on its or their behalf (collectively, "Vishay"), disclaim any and all liability for any errors, inaccuracies or incompleteness contained in any datasheet or in any other disclosure relating to any product.

Vishay makes no warranty, representation or guarantee regarding the suitability of the products for any particular purpose or the continuing production of any product. To the maximum extent permitted by applicable law, Vishay disclaims (i) any and all liability arising out of the application or use of any product, (ii) any and all liability, including without limitation special, consequential or incidental damages, and (iii) any and all implied warranties, including warranties of fitness for particular purpose, non-infringement and merchantability.

Statements regarding the suitability of products for certain types of applications are based on Vishay's knowledge of typical requirements that are often placed on Vishay products in generic applications. Such statements are not binding statements about the suitability of products for a particular application. It is the customer's responsibility to validate that a particular product with the properties described in the product specification is suitable for use in a particular application. Parameters provided in datasheets and / or specifications may vary in different applications and performance may vary over time. All operating parameters, including typical parameters, must be validated for each customer application by the customer's technical experts. Product specifications do not expand or otherwise modify Vishay's terms and conditions of purchase, including but not limited to the warranty expressed therein.

Except as expressly indicated in writing, Vishay products are not designed for use in medical, life-saving, or life-sustaining applications or for any other application in which the failure of the Vishay product could result in personal injury or death. Customers using or selling Vishay products not expressly indicated for use in such applications do so at their own risk. Please contact authorized Vishay personnel to obtain written terms and conditions regarding products designed for such applications.

No license, express or implied, by estoppel or otherwise, to any intellectual property rights is granted by this document or by any conduct of Vishay. Product names and markings noted herein may be trademarks of their respective owners.