



MIL-STD-1553

DATA BUS CONNECTORS

MIL-STD-1760

STORES MANAGEMENT CONNECTORS

by **PYLE-NATIONAL**



MIL-STD-1553

Pyle-National has a long history as a quality manufacturer of circular, military specification connectors. From our connector series qualified to MIL-C-38999 Series III, Pyle has utilized qualified military components to develop a series of connectors for MIL-STD-1553 applications. In addition, Pyle offers a qualified lanyard release connector, D38999/31, for stores management requirements as outlined in MIL-STD-1760.

MIL-STD-1553 bussing is used by military designers of Tri-Service and NATO programs to interconnect control and display systems used in communication, navigation, avionics, fire control, and stores management. Basic to the interconnection network is a military qualified, #8 twinax contact for the transmission of video signals.

The #8 twinax contacts are housed in connectors using MIL-C-38999 Series III design concepts in single and multi-contact arrangements. A variety of configurations accommodating Pyle's qualified coax contacts are also available for the transmission of high speed computer signals.

For MIL-STD-1553 bussing and MIL-STD-1760 stores management, THINK PYLE for all of the following:

- Qualified #8 twinax contacts—M39029/90-529, /91-530
- Double shielded #8 twinax contacts
- Qualified lanyard release plug—D38999/31
- Qualified variety of coax contacts—#8, #12 & #16
- Single contact #8 twinax connectors—Removable contacts
- Multi-contact configurations, #8 twinax
- Hybrid configurations, #8 twinax, coax, power & signal
- Cable conforming to MIL-C-17/176

CONNECTOR TYPES AND FEATURES



MIL-C-38999 Series III Environmental Multi-Pin Connectors (Classes F & W)

- High Vibration Capability.
- Metal to Metal Bottoming.
- Non-decoupling threaded plug fully couples in 360°.
- "Scoop-Proof" design.
- 500 cycle mating durability.
- High EMI-RFI shielding effectiveness.
- #8 Removable Contact Seal Boot.

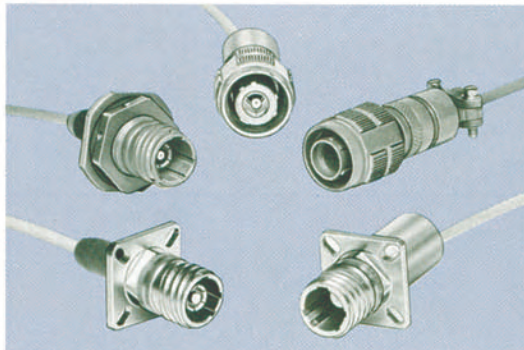

SINGLE CONTACT Connectors—Removable #8 Twinax/Coax Contact

- Uses qualified D38999 III shells—size 9 with removable contact design.
- Accepts a wide variety of #8 Twinax/Coax contacts—including M39029/90, /91 series.
- Supplied with innovative boot design for sealing and stability.
- Available in two sealing designs—fixed integral seal or removable boot seal.
- Miniature light weight design.

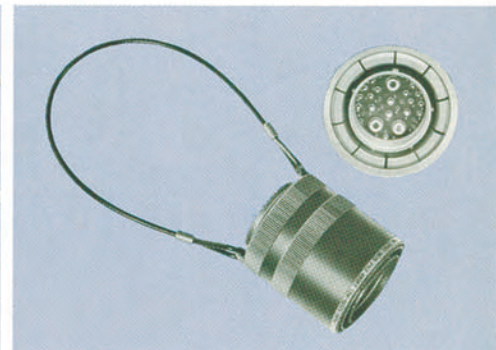

MIL-STD-1760 Lanyard Release/Stores Management Connectors

- Incorporates full design features of D38999 III.
- Non-decoupling threaded plug fully couples in 360°.
- Moisture/ice resistant seal.
- Intermateable with standard MIL-C-38999 Series III receptacles.
- Accepts MIL-C-85049 back-shell hardware.

INSERT ARRANGEMENTS

For #8, #12 & #16 Shielded Contacts
(Front Face of Socket Inserts Illustrated)

NOTE: For information on shielded contacts, see page 9.

Military Designation
Insert arrangement
Service rating
Contacts



—
9-01†Δ
M
1#8 Twinax

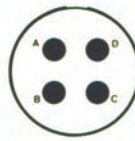

—
15-04†
II
4#16

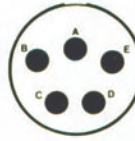

D05
15-05
II
5#16

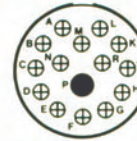

D15
15-15
I
14#20, 1#16

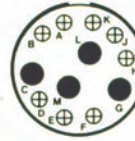

D97
15-97
I
8#20, 4#16

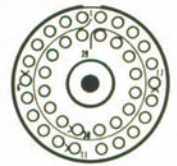

—
17-02†Δ
1#8 Twinax
38#22D

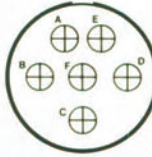

E06
17-06
I
6#12

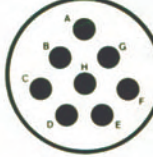

E08
17-08
II
8#16

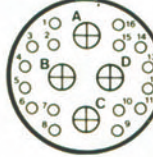

—
17-20†
M
4#12, 16#22D

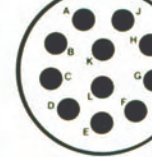

F11
19-11
II
11#16



G11
21-11
I
11#12

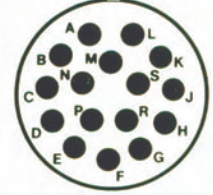

G16
21-16
II
16#16

Military Designation
Insert arrangement
Service rating
Contacts

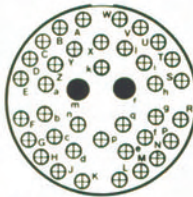

G39
21-39
I
37#20, 2#16

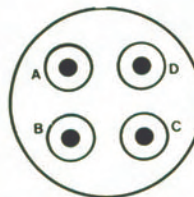

—
21-75†Δ
M
4#8 Twinax

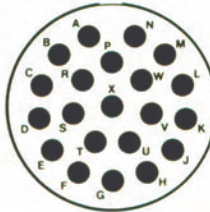

H21
23-21
II
21#16

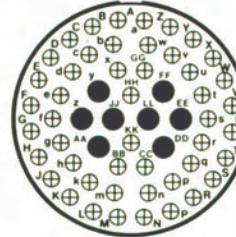

J04
25-04
I
8#16, 48#20

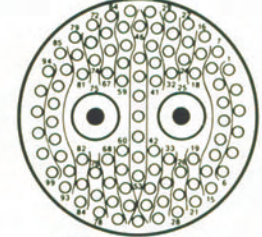

—
25-07†Δ
N
2#8 Twinax,
97#22D

Military Designation
Insert arrangement
Service rating
Contacts

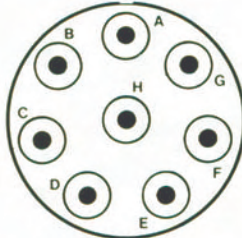

—
25-08†Δ
M
8#8 Twinax

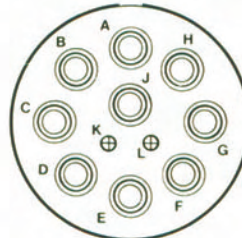

J11
25-11
N
9#10, 2#20

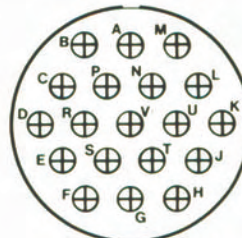

J19
25-19
I
19#12

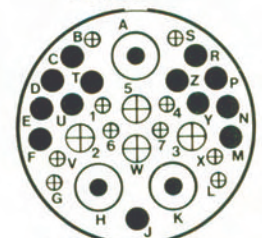

J20
25-20*
N
3#8 Twinax, 4#12
13#16, 10#20

Military Designation
Insert arrangement
Service rating
Contacts

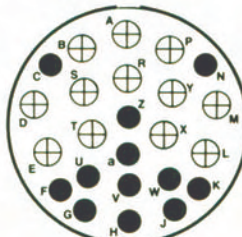

J24
25-24
I
12#16, 12#12

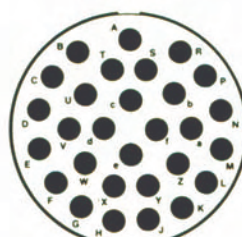

J29
25-29
I
29#16

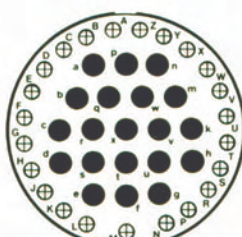

J43
25-43
I
23#20, 20#16



—
25-46Δ
I
2#8 Twinax, 4#16
40#20

Military Designation
Insert arrangement
Service rating
Contacts

CONTACT LEGEND



† Non-Military Arrangement

* #8 Twinax with qualified heat shrink boot

Δ #8 Twinax/Coax with removable contact seal boot

NOTE: #8 Coax contact may be substituted for the #8 Twinax.

SERVICE RATING

Service Rating	Suggested Operating Voltage (Sea Level)		Test Voltage (Sea Level)	Test Voltage 50,000 Ft.	Test Voltage 70,000 Ft.	Test Voltage 100,000 Ft.
	AC (RMS)	DC				
I	600	850	1800 V RMS	600 V RMS	400 V RMS	200 V RMS
II	900	1250	2300 V RMS	800 V RMS	500 V RMS	200 V RMS
M	400	550	1300 V RMS	550 V RMS	350 V RMS	200 V RMS
N	230	270	1000 V RMS	400 V RMS	260 V RMS	200 V RMS

Please note that the establishment of electrical safety factors is left entirely in the designer's hands, since he is in the best position to know what peak voltages, switching surges, transients, etc., can be expected in a particular circuit.

MIL-C-38999 SERIES III Environmental Connectors

The connectors detailed in this series identify the D38999 Series III qualified shell styles with arrangements noted on page 3 that are available for use with shielded contacts. Connectors accommodate coax/twinax contacts as well as numerous hybrid configurations that offer power and signal contacts with a variety of shielded conductors. Pyle uses a standard military style heat shrink boot with configuration 25-20 and an alternate removable boot seal with the balance of the #8 cavity configurations. (See Bulletin MS-103 for complete information on MIL-C-38999 Series III Connectors.)

SPECIFICATIONS

(IN INCHES UNLESS OTHERWISE STATED)

NON-DECOUPLING PLUG D38999/26

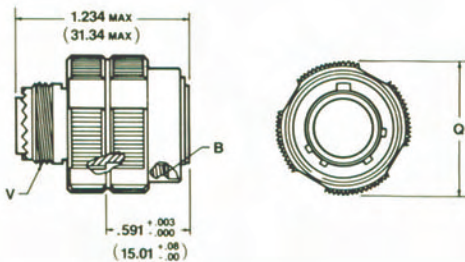

Shell Size	MS Shell Size Code	B Thread 0.1P-0.3L-TS-2B	Q Max.	V Thread Metric
15	D	1.0000	1.279	M22X1-6g
17	E	1.1875	1.405	M25X1-6g
19	F	1.2500	1.515	M28X1-6g
21	G	1.3750	1.641	M31X1-6g
23	H	1.5000	1.767	M34X1-6g
25	J	1.6250	1.889	M37X1-6g

ENVIRONMENTAL WALL-MOUNT RECEPTACLE D38999/20

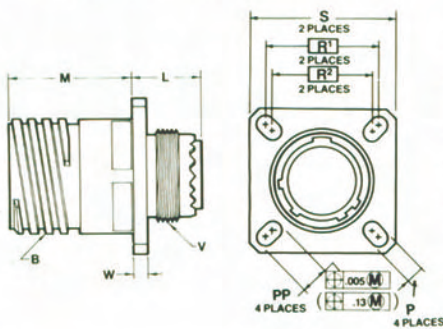

Shell Size	MS Shell Size Code	B Thread Class 2A 0.1P-0.3L-TS	L Max.	M +.000 / -.006	R ¹	R ²	S ±.010	P ±.005	W +.000 / -.006	PP ±.005	V Thread Metric
15	D	1.0000	.469	.822	.969	.906	1.219	.128	.097	.173	M22X1-6g
17	E	1.1875	.469	.822	1.062	.969	1.312	.128	.097	.194	M25X1-6g
19	F	1.2500	.469	.822	1.156	1.062	1.438	.128	.097	.194	M28X1-6g
21	G	1.3750	.500	.790	1.250	1.156	1.562	.128	.125	.194	M31X1-6g
23	H	1.5000	.500	.790	1.375	1.250	1.688	.154	.125	.242	M34X1-6g
25	J	1.6250	.500	.790	1.500	1.375	1.812	.154	.125	.242	M37X1-6g

ENVIRONMENTAL JAM-NUT RECEPTACLE D38999/24

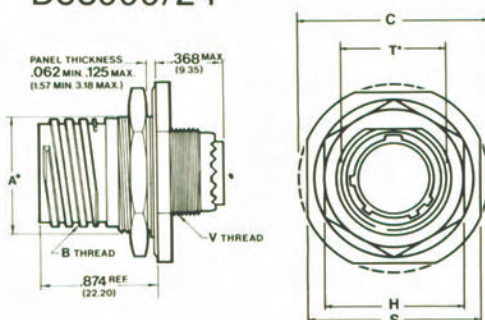

Shell Size	MS Shell Size Code	A* -.000 / +.010	B Thread Class 2A 0.1P-0.3L-TS	C Max.	H Hex -.000 / +.034	S Flat ±.010	T* -.010 / +.000	V Thread Metric
15	D	1.084	1.0000	1.636	1.417	1.500	1.134	M22X1-6g
17	E	1.208	1.1875	1.761	1.457	1.625	1.259	M25X1-6g
19	F	1.333	1.2500	1.949	1.614	1.812	1.384	M28X1-6g
21	G	1.459	1.3750	2.073	1.811	1.938	1.507	M31X1-6g
23	H	1.575	1.5000	2.199	1.969	2.062	1.634	M34X1-6g
25	J	1.709	1.6250	2.323	1.969	2.188	1.759	M37X1-6g

PART NUMBER/ORDERING INFORMATION

Military Designation

D38999 /20 W J 20 S N

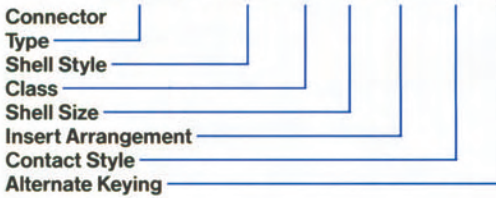

SHELL STYLE

- 26 Plug
- 20 Wall Mount Receptacle
- 24 Jam Nut Receptacle

CLASS

- K Stainless Steel Firewall
- W Olive Drab, Cadmium Plated Aluminum
- F Electroless Nickel Plated Aluminum
- S Electrodeposited Nickel Plated Stainless Steel Environmental

SHELL SIZE

- D E F G H J
- 15 17 19 21 23 25

INSERT ARRANGEMENT

See Chart

CONTACT STYLE

- P = Pin, S = Socket
- A = Less Pin Contacts when other than standard power M39029/58
- B = Less Socket Contacts when other than standard power M39029/56

ALTERNATE KEYING

- N = Normal
- A, B, C, D and E = Alternates

Pyle Designation

T3 W - 17 (*) 25 - 20 S N - (XXX)

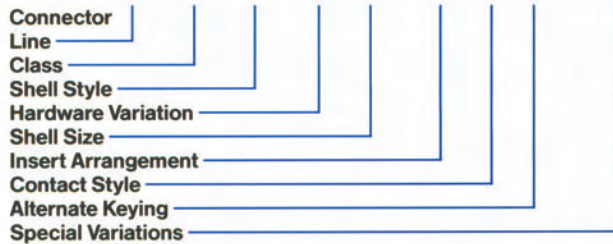

CLASS

- K Stainless Steel Firewall
- S Stainless Steel, Non-Firewall
- W Olive Drab, Cadmium Plated Aluminum
- F Electroless Nickel Plated Aluminum
- N Electrodeposited Nickel Plated Stainless Steel

SHELL STYLE

- 12 Plug
- 17 Wall Mount Receptacle
- 19 Jam Nut Receptacle

HARDWARE VARIATION

- B Contact Seal Boot

SHELL SIZE

- 15 17 19 21 23 25

INSERT ARRANGEMENT

See Chart (Page 3)

CONTACT STYLE

- P = Pin, S = Socket
- A = Less Pin Contacts, when other than standard power M39029/58 Pin Contacts
- B = Less Socket Contacts, when other than standard power M39029/56 Socket Contact

ALTERNATE KEYING

- N = Normal
- A, B, C, D and E = Alternates

SPECIAL VARIATIONS

- 105 = Less Contacts
 - 146 = Class W Plug with 1 Milliohm Requirement
 - 150 = Connector Supplied with #8 Double-Shielded Twinax Contacts (T3-46TB/47 TB style)
- Note: Consult factory for other variations

Alternate Keying Positions

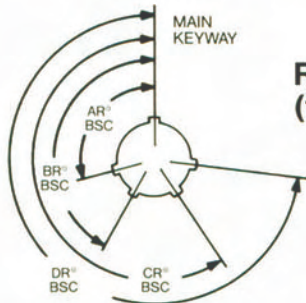

RECEPTACLE
(front face shown)

PLUG
(front face shown)

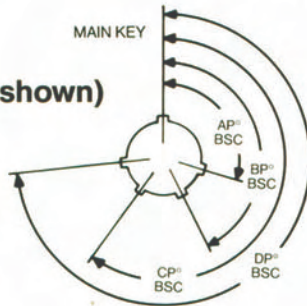

- Notes:
1. All angles are basic.
 2. Main keys/keyways and inserts remain fixed in "N" normal position. Auxiliary keys/keyways are shifted for alternate keying.

Main key/keyway polarization

Shell Size	Key & keyway arrangement identification letter	AR° or AP° BSC	BR° or BP° BSC	CR° or CP° BSC	DR° or DP° BSC
9	N	105	140	215	265
	A	102	132	248	320
	B	80	118	230	312
	C	35	140	205	275
	D	64	155	234	304
11, 13, and 15	E	91	131	197	240
	N	95	141	208	236
	A	113	156	182	292
	B	90	145	195	252
	C	53	156	220	255
17 and 19	D	119	146	176	298
	E	51	141	184	242
	N	80	142	196	293
	A	135	170	200	310
	B	49	169	200	244
21, 23, and 25	C	66	140	200	257
	D	62	145	180	280
	E	79	153	197	272
	N	80	142	196	293
	A	135	170	200	310
	B	49	169	200	244
	C	66	140	200	257
	D	62	145	180	280
	E	79	153	197	272

#8 SINGLE CONTACT Twinax Connectors

For weight/space saving MIL-STD-1553 Data Bussing Requirements, Pyle-National offers two (2) innovative Single Contact Connector designs. These designs utilize Qualified MIL-C-38999 Series III Shell Size 9 hardware and a wide variety of qualified and specialized #8 Twinax/Coax contacts.

Available in various shell styles, shell materials, and plating options (Classes F, W, K & S), each connector option incorporates unique design features.

SPECIFICATIONS (IN INCHES UNLESS OTHERWISE STATED)

Removable Contact Seal Boot Design

DESIGN FEATURES

- Insertable/removable #8 crimp twinax/coax contacts
- Sealing achieved by a removable contact/cable seal boot
- Plugs accept #8 socket twinax/coax contacts
- Receptacles accept #8 pin twinax/coax contacts
- Environmentally sealed
- Available with cable support
- Scoop-proof design
- Low profile design
- Contact grounded to shell

OPTIONAL CABLE SUPPORT TGW-R-5309-10 (Olive Drab Cadmium) TGF-R-5309-10 (Electroless Nickel)

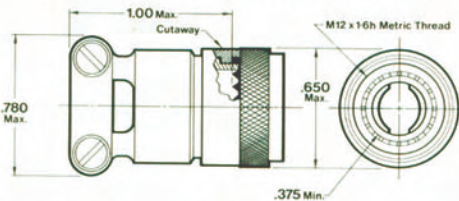

NON-DECOUPLING PLUG

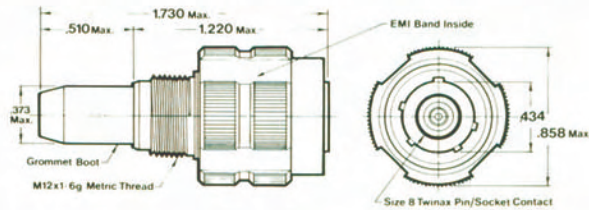

SQUARE FLANGE RECEPTACLE

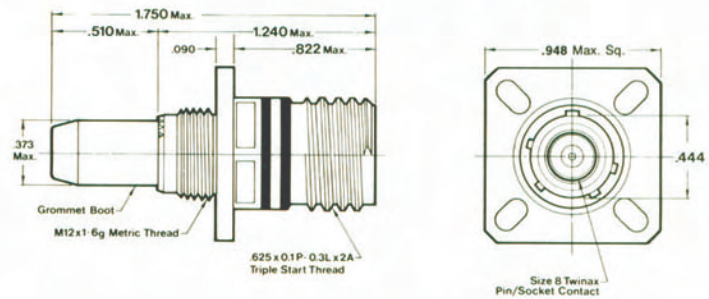

IN-LINE RECEPTACLE

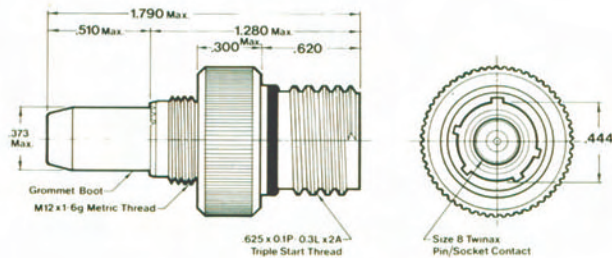

JAM-NUT RECEPTACLE

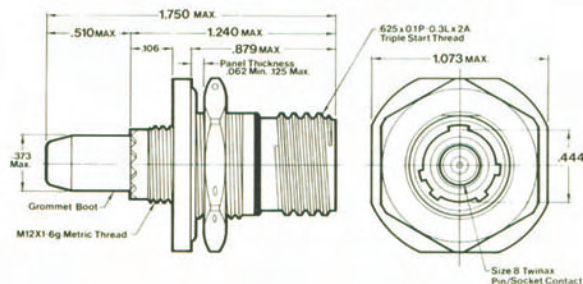

SPECIFICATIONS (IN INCHES UNLESS OTHERWISE STATED)

Fixed Integral Seal Design

DESIGN FEATURES

- Insertable/removable #8 crimp twinax/coax contacts
- Sealing achieved by a fixed integral contact/cable seal
- Plugs accept #8 socket twinax/coax contacts
- Receptacles accept #8 pin twinax/coax contacts
- Environmentally sealed
- Closed entry plug shell
- Scoop-proof design
- Contact grounded to shell

NON-DECOUPLING PLUG

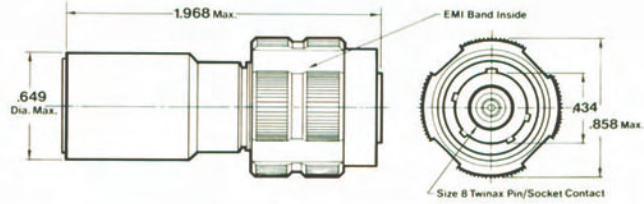

SQUARE FLANGE RECEPTACLE

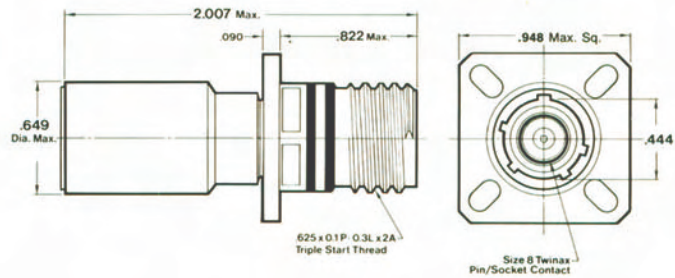

JAM-NUT RECEPTACLE

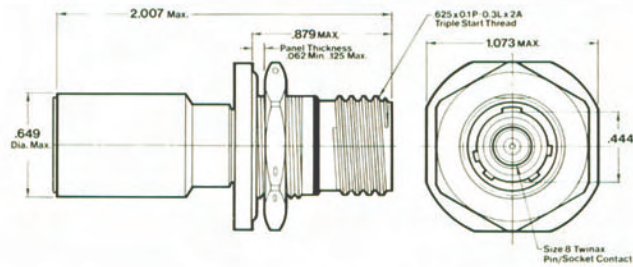

Note: Use contact removal tool part number TP-201391-8

PART NUMBER/ORDERING INFORMATION

#8 Single Contact Twinax Connectors

TG W - 12 B 09 -01 S N A

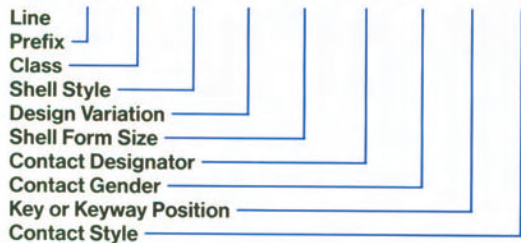

CLASS

- F Electroless Nickel Plated Aluminum
- W Corrosion Resistant Olive Drab Cadmium
- K Corrosion Resistant, Stainless Steel
- S Stainless Steel Electrodeposited Nickel Plated

SHELL STYLE

- 12 Plug
- 17 Receptacle
- 18 In-line Receptacle
- 19 Receptacle, Jam Nut Mount

DESIGN VARIATION

- A = Fixed integral seal adapter
- B = Removable grommet boot assembly

SHELL FORM SIZE

- 09 = Shell form size 9

CONTACT DESIGNATOR

- 01 = (1) #8 contact

CONTACT GENDER

- P = Pin (use with receptacle only)
- S = Socket (use with plug only)

KEY OR KEYWAY POSITION

- N = Normal
- A, B, C, D & E = Alternate

CONTACT STYLE

- (Omit for standard #8 twinax contact per MIL-C-39029/90 and /91)

- B = #8 twinax ("TB" style)*

- C = #8 coax contact*

- 105 designator for "without contacts"

*See Pyle Part numbers on Shielded Contacts table, page 9.

MIL-STD-1760

Lanyard Release/ Stores Management Connectors

Designed to meet all the requirements of MIL-STD-1760 and Stanag 3837 AA for electrical interface between an aircraft and its stores. Designed to comply with D38999/31 (plug) and to mate with D38999/20 and 24 (receptacles). Provides for instant disconnect at any stage of coupling and incorporates all the features of standard T3W series MIL-C-38999 series III connectors.

SPECIFICATIONS

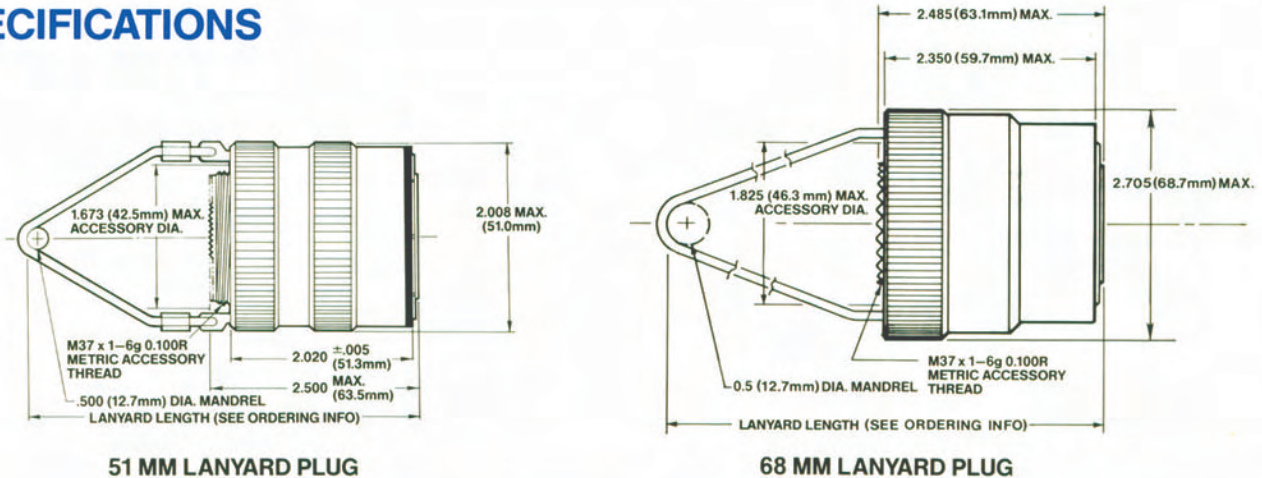

51 MM LANYARD PLUG

68 MM LANYARD PLUG

PART NUMBER/ORDERING INFORMATION

Military Designation

D38999 /31 W E 20 N 1

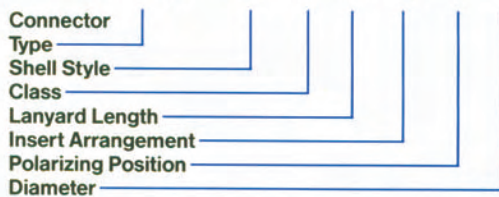

Shell Style

31 Lanyard Release Plug

Class

W Olive Drab, Cadmium Plated Aluminum

Lanyard Length

E	F	G	H
153MM	166MM	178MM	191MM

Insert Arrangement

11, 20 (See Page 3)

Polarizing Position

N = Normal, A = Alternate

Diameter

1 = 51MM (2.008 inch max.)
2 = 68MM (2.705 inch max.)

Pyle Designation

T3 W - 16B 25 - 20 P N E - (XXX)

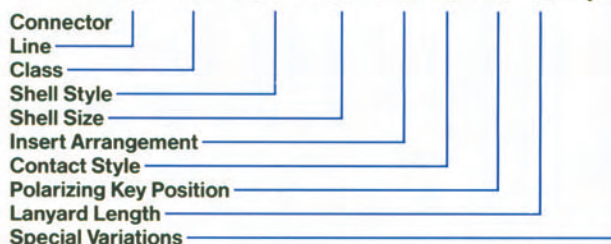

Class

W Olive Drab, Cadmium Plated Aluminum

Shell Style

16A 68MM Plug (2.705 inch max. dia.)
16B 51MM Plug (2.008 inch max. dia.)

Shell Size

25

Insert Arrangement

11, 20 (See Page 3)

Contact Style*

P = Pin
S = Socket

Polarizing Key Position

N = Normal, A = Alternate

Lanyard Length

E	F
6 in./153MM	6.5 in./166MM
G	H
7 in./178MM	7.5 in./191MM

Special Variation

-105 = Less Contacts

*When ordered to D38999/31, available in pin contact only.

Note: For non-standard variations, consult the Pyle-National Military/Aerospace group.

MIL-STD-1553/MIL-STD-1760

CONTACTS AND ACCESSORIES

POWER CONTACTS

CONTACT SIZE	PINS			SOCKETS			SEAL PLUGS	
	Spec. Number	Superceded MS No.	Pyle Number	Spec. Number	Superceded MS No.	Pyle Number	Spec. Number	Pyle Number
22D	M39029/58-360	27493-22D	T3-4022-36LD	M39029/56-348	27490-22D	T3-4122-36LD	M27488-22 Black	T3-4022-59L
20	M39029/58-363	27493-20	T3-4020-36LD	M39029/56-351	27490-20	T3-4120-36LD	M27488-20 Red	T3-4020-59L
16	M39029/58-364	27493-16	T3-4016-36LD	M39029/56-352	27490-16	T3-4116-36LD	M27488-16 Blue	T3-4016-59L
12	M39029/58-365	27493-12	T3-4012-36LD	M39029/56-353	27490-12	T3-4112-36LD	M27488-12 Yellow	T3-4012-59L
10	M39029/58-528	—	T3-4010-36LD	M39039/56-527	—	T3-4110-36LD	—	T3-4010-59L

SHIELDED CONTACTS

CONTACT SIZE	PINS			SOCKETS			CABLE ACCOMMODATIONS	SEAL PLUGS *
	Spec. Number	Superceded Mil. No.	Pyle Number	Spec. Number	Superceded Mil. No.	Pyle Number		
16 Coax	M39029/76-424	M39029/76-16A	T3-4616-424-LD	M39029/77-428	M39029/77-16A	T3-4716-428-LD	RG174, 179, 316	—
12 Coax	M39029/28-211	M39029/28-12A	T3-4612-211-LD	M39029/75-416	M39029/75-12A	T3-4712-416-LD	RG174, 179, 316	T3-4012-58P
12 Coax	M39029/28-409	M39029/28-12B	T3-4612-409-LD	M39029/75-417	M39029/75-12B	T3-4712-417-LD	RG180	
12 Double Shielded	M39029/28-414	—	T3-4612-414-LD	M39029/75-422	—	T3-4712-422-LD	RG316 M17/152-00001	
8 Coax	M39029/59-366†	MS27535	T3-4608-LD	M39029/60-367†	MS27536	T3-4708-LD	RG180	T3-4008-58P
8 Twinax	M39029/90-529	—	T3-46T08-LD	M39029/91-530	—	T3-47T08-LD	M17/176-00002 ▷3,▷4,▷5	
8 Double Shielded Twinax	—	—	T3-46TB08-LD	—	—	T3-47TB08-LD	▷1,▷2	

Notes: ▷See page 10 for applicable cable equivalents.
 * Seal plugs designed to accommodate total contact cavity.
 †Non-qualified: intermateable with qualified products.

CONTACT SEAL BOOT (for #8 Cavity)

PART NUMBER	DESCRIPTION
T3-46T08-117	HEAT SHRINK BOOT (supplied with contacts when ordered to M39029/90, 91)
T3-R-6308	REMOVABLE BOOT (optional sealing design)

REMOVABLE BOOT

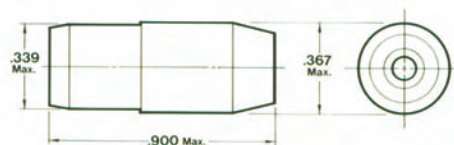

CONTACTS AND ACCESSORIES (cont.)

AVAILABLE DATA BUS CABLES for use with Pyle-National #8 Twinax Contacts

▷	BRAND-REX PART NUMBER	RAYCHEM PART NUMBER	DESCRIPTION
▷ 1	T-12967	10614	Qualified to Northrop 05A077—EMP hardened, XL tefzel, Twinax with 2/#24 AWG conductors
▷ 2	T-10970	10613	Qualified to Northrop 05A078—Optomized double shielded, XL tefzel, Twinax with 2/#24 AWG conductors
▷ 3	T-12701	—	Equivalent to M17/176-00002—Single shield Twinax with 2/#24 AWG conductors
▷ 4	T-10545	—	Single shield Twinax, low halogen with 2/#24 AWG conductors
▷ 5	T-12569	10595	Single shield Twinax, XL tefzel with 2/#24 AWG conductors

NOTE: For additional information on Pyle-National Contact/Data Bus Cable combinations consult the Pyle-National Military/Aerospace group.

CONTACT INSERTION REMOVAL TOOLS

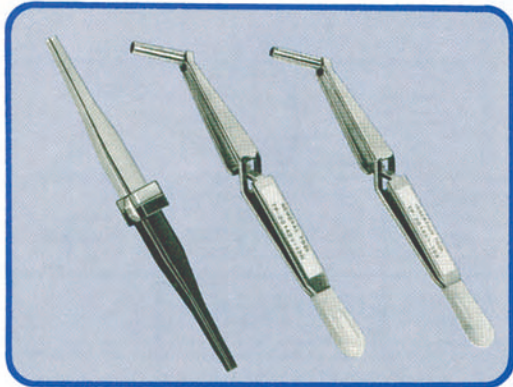

Contact Size	Plastic Insertion/Removal	Metal	
		Insertion	Removal
22	TP-201391-22D	TP-201421-22A	TP-201421-22R
20	TP-201391-20	TP-201421-20A TP-201428-20A*	TP-201421-20R TP-201428-20R*
16	TP-201343-16BA	TP-201421-16A TP-201428-16A*	TP-201421-16R TP-201428-16R*
12	TP-201391-12	TP-201421-12A TP-201428-12A*	TP-201421-12R TP-201428-12R*
10	—	TP-201428-10A*	TP-201428-10R*
8	TP-201391-8	TP-201428-8A*	TP-201428-8R*

*Part number for straight tool. Required for contact assembly of D38999/31 Lanyard plugs.

CRIMPING TOOLS for POWER CONTACTS

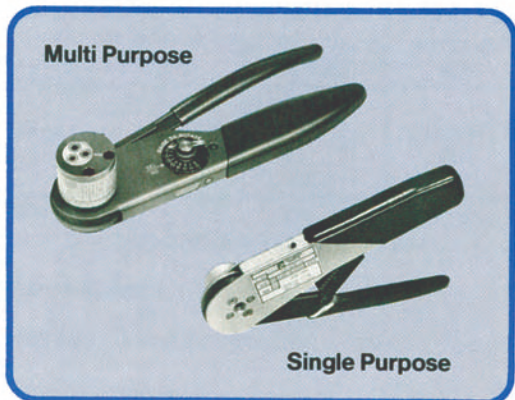

DESCRIPTION	CONT. SIZE	PYLE NO.	MIL. NO.
Crimping Tool	22D	TP-201401-H2	M22520/2-01
Socket Contact Positioner		TP-201401-2-07	M22520/2-07
Pin Contact Positioner		TP-201401-2-09	M22520/2-09
Checking Gage for Crimp Tool		TP-201356	M22520/3-1
Adjustable Crimp Tool	20	TP-201354	M22520/1-01
Turret Head	16	TP-201401-1-04	M22520/1-04
Checking Gage for Crimp Tool	12	TP-201356	M22520/3-1
Crimping Tool with Contact Positioner	10	TP-201423	—

- Notes: 1. TP-201354 Crimp Tool Handle is available in a package with Turret Head TP-201401-1-04. It carries part number TP-201401.
 2. TP-201401-H2 Crimp Tool Handle is available in a package with size 22D pin positioner TP-201401-2-09. It carries part number TP-201401-P.
 3. TP-201401-H2 Crimp Tool Handle is available in a package with size 22D socket positioner TP-201401-2-07. It carries part number TP-201401-S.

CRIMPING TOOLS for SHIELDED CONTACTS

TP-201401-H2

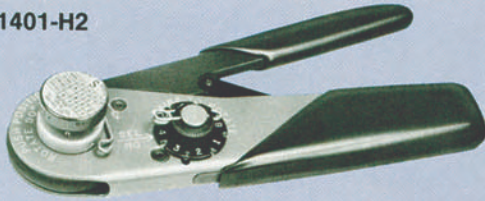

TP-201380-T0

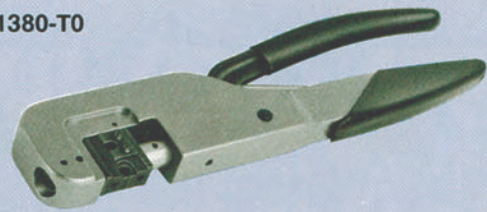

TP-201427

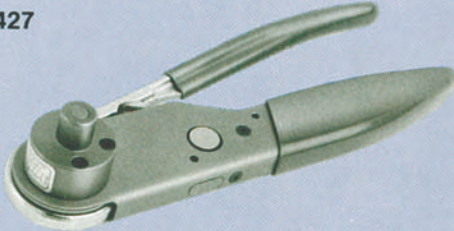

TP-201441

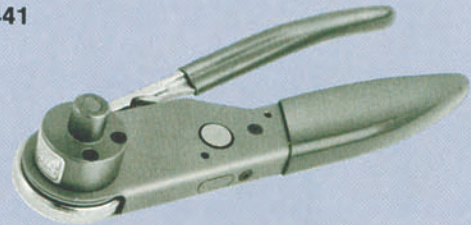

For #8 TWINAX CONTACTS

T3-46T08-LD and T3-47T08-LD, T3-46TB08-LD and T3-47TB08-LD

	CENTER CONTACT		INTERMEDIATE CONTACT		OUTER CRIMP SLEEVE (BRAID)	
	BASIC CRIMPING TOOL	CONTACT POSITIONER	BASIC CRIMPING TOOL	DIE PART NO.	BASIC CRIMPING TOOL	DIE PART NO.
Spec. Number	M22520/2-01	—	M22520/5-01	—	M22520/5-01	—
Pyle Number	TP-201401-H2	TP-201424	TP-201380-T0	TP-201425	TP-201380-T0	TP-201425

For #8 COAX CONTACTS

T3-4608-LD and T3-4708-LD

	INNER CONTACT		OUTER CONTACT (BRAID)	
	BASIC CRIMPING TOOL	CONTACT POSITIONER	BASIC CRIMPING TOOL	DIE PART NO.
Spec. Number	M22520/2-01	M22520/2-31	M22520/5-01	M22520/5-05
Pyle Number	TP-201401-H2	TP-201442	TP-201380-T0	TP-201443

For #12 COAX CONTACT

T3-4612-211-LD and T3-4712-416-LD, T3-4612-409-LD and T3-4712-417-LD, T3-4612-414-LD and T3-4712-422-LD

	INNER CONTACT		OUTER CONTACT (BRAID)		
	BASIC CRIMPING TOOL	CONTACT POSITIONER	BASIC CRIMPING TOOL	CONTACT POSITIONER	COMPLETE PART NO.
Spec. Number	M22520/2-01	M22520/2-34	M22520/31-01	M22520/31-02	—
Pyle Number	TP-201401-H2	TP-201426	TP-201427-T0	TP-201427-CP	TP-201427

For #16 COAX CONTACT

T3-4616-424-LD and T3-4716-428-LD

	INNER CONTACT		OUTER CONTACT (BRAID)		
	BASIC CRIMPING TOOL	CONTACT POSITIONER	BASIC CRIMPING TOOL	CONTACT POSITIONER	COMPLETE PART NO.
Spec. Number	M22520/2-01	M22520/2-35	M22520/4-01	M22520/4-02	—
Pyle Number	TP-201401-H2	TP-201440	TP-201441-T0	TP-201441-CP	TP-201441

For additional information on tooling termination requirements, consult the Pyle-National Military/Aerospace group.