

Middle Power LED Series
2835 1.0W 9V Ra90 Hot bin

LM283B+



Designed for better lm/\$ (Lamps)

Features & Benefits

- 0.9W Class mid power LED
- Standard form factor for design flexibility (2.8 × 3.5 × 0.65mm)



Table of Contents

1.	Characteristics	-----	3
2.	Product Code Information	-----	6
3.	Typical Characteristics Graphs	-----	16
4.	Outline Drawing & Dimension	-----	19
5.	Reliability Test Items & Conditions	-----	20
6.	Soldering Conditions	-----	21
7.	Tape & Reel	-----	22
8.	Label Structure	-----	25
9.	Packing Structure	-----	26
10.	Precautions in Handling & Use	-----	30

1. Characteristics

a) Absolute Maximum Rating

Item	Symbol	Rating	Unit	Condition
Ambient / Operating Temperature	T_a	-40 ~ +85	°C	-
Storage Temperature	T_{stg}	-40 ~ +85	°C	-
LED Junction Temperature	T_j	125	°C	-
Forward Current	I_F	110	mA	-
Peak Pulsed Forward Current	I_{FP}	200	mA	Duty 1/10, pulse width 10ms
Assembly Process Temperature	-	260 <10	°C s	-
ESD (HBM)	-	2	kV	-

Note:

Proper current derating must be observed to maintain junction temperature below the maximum at all time.

b) Electro-optical Characteristics ($I_F = 100 \text{ mA}$, $T_s = 25 \text{ }^\circ\text{C}$)

Item	Unit	Rank	Bin	Min.	Typ.	Max.
Forward Voltage (VF)	V	SG or SK	GZ	8.8	-	9.1
			G1	9.1	-	9.4
			G2	9.4	-	9.7
			G3	9.7	-	10.0
Color Rendering Index (Ra)	-	7		90	-	-
Special CRI (R9)	-	-		50		
Thermal Resistance (junction to solder point)	$^\circ\text{C/W}$			-	15	-
Beam Angle	$^\circ$			-	120	-

Note:

Samsung maintains measurement tolerance of: forward voltage = $\pm 0.2 \text{ V}$, CRI = ± 3 , R9 = ± 6.5

b) Electro-optical Characteristics (I_F = 100 mA, T_s = 25 °C)

Item	CRI (R _a) Min.	Nominal CCT (K)	Bin	100mA	
				Min.	Max.
Luminous Flux (Φ _v)	90	2700	SA	88	94
			SB	94	104
		3000	SA	91	98
			SB	98	108
		3500	SA	93	100
			SB	100	110
		4000	SA	96	103
			SB	103	113
		5000	SA	98	105
			SB	105	115
		5700	SA	97	104
			SB	104	114
		6500	SA	96	103
			SB	103	113

Note:

Samsung maintains measurement tolerance of: forward voltage = ±0.2V, luminous flux = ±5 %, CRI = ±3, R9 = ±6.5

2. Product Code Information

1	2	3	4	5	6	7	8	9	10	11	12	13	14	15	16	17	18
S	P	M	W	H	1	2	2	9	A	Q	7	S	G	R	0	S	A

Digit	PKG Information	Code	Specification			
1 2 3	Samsung Package Middle Power	SPM	Middle power			
4 5	Color	WH	White			
6	Product Version	1	1 st version			
7 8 9	Form Factor	229	2.8 x 3.5 x 0.65 mm; 2 pads; 3chip;			
10	Sorting Current (mA)	A	100 mA			
11	Chromaticity Coordinates	Q	Hot bin			
12	CRI	7	Min. 90			
13 14	Forward Voltage (V)	SG or SK	8.8~10.0 Bin Code	GZ	8.8 ~ 9.1	
				G1	9.1 ~ 9.4	
				G2	9.4 ~ 9.7	
				G3	9.7 ~ 10.0	
			SG : 4,000ea per reel ,SK : 16,000ea per reel			
15 16	CCT (K)	W☆	2700	W1, W2, W3, W4, W5, W6, W7, W8, W9, WA, WB, WC, WD, WE, WF, WG		
		V☆	3000	V1, V2, V3, V4, V5, V6, V7, V8, V9, VA, VB, VC, VD, VE, VF, VG		
		U☆	3500	U1, U2, U3, U4, U5, U6, U7, U8, U9, UA, UB, UC, UD, UE, UF, UG		
		T☆	4000	Bin Code:	T1, T2, T3, T4, T5, T6, T7, T8, T9, TA, TB, TC, TD, TE, TF, TG	
		R☆	5000	R1, R2, R3, R4, R5, R6, R7, R8, R9,RA,RB,RC,RD,RE,RF,RG		
		Q☆	5700	Q1, Q2, Q3, Q4, Q5, Q6, Q7, Q8, Q9,QA,QB,QC,QD,QE,QF,QG		
		P☆	6500	P1, P2, P3, P4, P5, P6, P7, P8, P9,PA,PB,PC,PD,PE,PF,PG		
			☆ : "0" (Whole bin) "M" (Quarter bin) or "K" (kitting bin)			
17 18	Luminous Flux	SA		SA		
		SB	Bin Code:	SB		

a) Luminous Flux Bins ($I_f = 100 \text{ mA}$, $T_s = 25^\circ\text{C}$)

CRI (R _a) Min.	Nominal CCT (K)	Product Code	Flux Bin	Flux Range (Φ_v , lm)
90	2700	SPMWH1229AQ7SGW☆SA	SA	88 ~ 94
		SPMWH1229AQ7SGW☆SB	SB	94 ~ 104
	3000	SPMWH1229AQ7SGV☆SA	SA	91 ~ 98
		SPMWH1229AQ7SGV☆SB	SB	98 ~ 108
	3500	SPMWH1229AQ7SGU☆SA	SA	93 ~ 100
		SPMWH1229AQ7SGU☆SB	SB	100 ~ 110
	4000	SPMWH1229AQ7SGT☆SA	SA	96 ~ 103
		SPMWH1229AQ7SGT☆SB	SB	103 ~ 113
	5000	SPMWH1229AQ7SGR☆SA	SA	98 ~ 105
		SPMWH1229AQ7SGR☆SB	SB	105 ~ 115
	5700	SPMWH1229AQ7SGQ☆SA	SA	97 ~ 104
		SPMWH1229AQ7SGQ☆SB	SB	104 ~ 114
	6500	SPMWH1229AQ7SGP☆SA	SA	96 ~ 103
		SPMWH1229AQ7SGP☆SB	SB	103 ~ 113

Note: "☆" can be "0" (Whole bin), "M" (Quarter bin) or "K" (Kitting bin) of the color binning

b) Kitting rule

1) Kitting bin Concept

1. Under agreement between customer and SAMSUNG ELECTRONICS, SAMSUNG can supply kitting bin (VF, Color, lm).
2. A forward voltage (VF) of kitting bin is combined by a pair of same VF rank such as (GZ+GZ), (G1+G1), (G2+G2) or (G3+G3).
3. A Chromaticity Coordinates of kitting bin is mixed by kitting procedure.(below kitting simulation)

[Kitting example]

D	E	F	G
9	A	B	C
5	6	7	8
1	2	3	4

[Binning Information]

	Bin #1	Bin #2
VF	GZ	GZ
	G1	G1
	G2	G2
	G3	G3
CIE	1, 2, 5 bin	C, F, G bin
	6, 7, A, B bin	6, 7, A, B bin
	3, 4, 8 bin	9, D, E bin

c) Color Bins ($I_F = 100 \text{ mA}$, $T_s = 25 \text{ }^\circ\text{C}$)

CRI (R _a) Min.	Nominal CCT (K)	Product Code	Color Rank	Chromaticity Bins
90	2700	SPMWH1229AQ7SGW0S★	W0 (Whole bin)	W1, W2, W3, W4, W5, W6, W7, W8, W9, WA, WB, WC, WD, WE, WF, WG
		SPMWH1229AQ7SGWMS★	WM (Quarter bin)	W6, W7, WA, WB
		SPMWH1229AQ7SGWKS★	WK (Kitting bin)	W1, W2, W3, W4, W5, W6, W7, W8, W9, WA, WB, WC, WD, WE, WF, WG
		SPMWH1229AQ7SGV0S★	V0 (Whole bin)	V1, V2, V3, V4, V5, V6, V7, V8, V9, VA, VB, VC, VD, VE, VF, VG
		SPMWH1229AQ7SGVMS★	VM (Quarter bin)	V6, V7, VA, VB
		SPMWH1229AQ7SGVKS★	VK (Kitting bin)	V1, V2, V3, V4, V5, V6, V7, V8, V9, VA, VB, VC, VD, VE, VF, VG
	3000	SPMWH1229AQ7SGU0S★	U0 (Whole bin)	U1, U2, U3, U4, U5, U6, U7, U8, U9, UA, UB, UC, UD, UE, UF, UG
		SPMWH1229AQ7SGUMS★	UM (Quarter bin)	U6, U7, UA, UB
		SPMWH1229AQ7SGUKS★	UK (Kitting bin)	U1, U2, U3, U4, U5, U6, U7, U8, U9, UA, UB, UC, UD, UE, UF, UG
		SPMWH1229AQ7SGT0S★	T0 (Whole bin)	T1, T2, T3, T4, T5, T6, T7, T8, T9, TA, TB, TC, TD, TE, TF, TG
		SPMWH1229AQ7SGTMS★	TM (Quarter bin)	T6, T7, TA, TB
		SPMWH1229AQ7SGTKS★	TK (Kitting bin)	T1, T2, T3, T4, T5, T6, T7, T8, T9, TA, TB, TC, TD, TE, TF, TG
	4000	SPMWH1229AQ7SGR0S★	R0 (Whole bin)	R1, R2, R3, R4, R5, R6, R7, R8, R9, RA, RB, RC, RD, RE, RF, RG
		SPMWH1229AQ7SGRMS★	RM (Quarter bin)	R6, R7, RA, RB
		SPMWH1229AQ7SGRKS★	RK (Kitting bin)	R1, R2, R3, R4, R5, R6, R7, R8, R9, RA, RB, RC, RD, RE, RF, RG
		SPMWH1229AQ7SGQ0S★	Q0 (Whole bin)	Q1, Q2, Q3, Q4, Q5, Q6, Q7, Q8, Q9, QA, QB, QC, QD, QE, QF, QG
		SPMWH1229AQ7SGQMS★	QM (Quarter bin)	Q6, Q7, QA, QB
		SPMWH1229AQ7SGQKS★	QK (Kitting bin)	Q1, Q2, Q3, Q4, Q5, Q6, Q7, Q8, Q9, QA, QB, QC, QD, QE, QF, QG
	5000	SPMWH1229AQ7SGP0S★	P0 (Whole bin)	P1, P2, P3, P4, P5, P6, P7, P8, P9, PA, PB, PC, PD, PE, PF, PG
		SPMWH1229AQ7SGPMS★	PM (Quarter bin)	P6, P7, PA, PB
		SPMWH1229AQ7SGPKS★	PK (Kitting bin)	P1, P2, P3, P4, P5, P6, P7, P8, P9, PA, PB, PC, PD, PE, PF, PG

Note:

★ can be "SA" or "SB" of luminous flux bin

d) Voltage Bins ($I_f = 100 \text{ mA}$, $T_s = 25 \text{ }^\circ\text{C}$)

CRI (R_a) Min.	Nominal CCT (K)	Product Code	Voltage Rank	Voltage Bin	Voltage Range (V)
-	-	-		GZ	8.8 ~ 9.1
			SG	G1	9.1 ~ 9.4
			or		
			SK	G2	9.4 ~ 9.7
				G3	9.7 ~ 10.0

e) Chromaticity Region & Coordinates ($I_F = 100 \text{ mA}$, $T_s = 25 \text{ }^\circ\text{C}$)

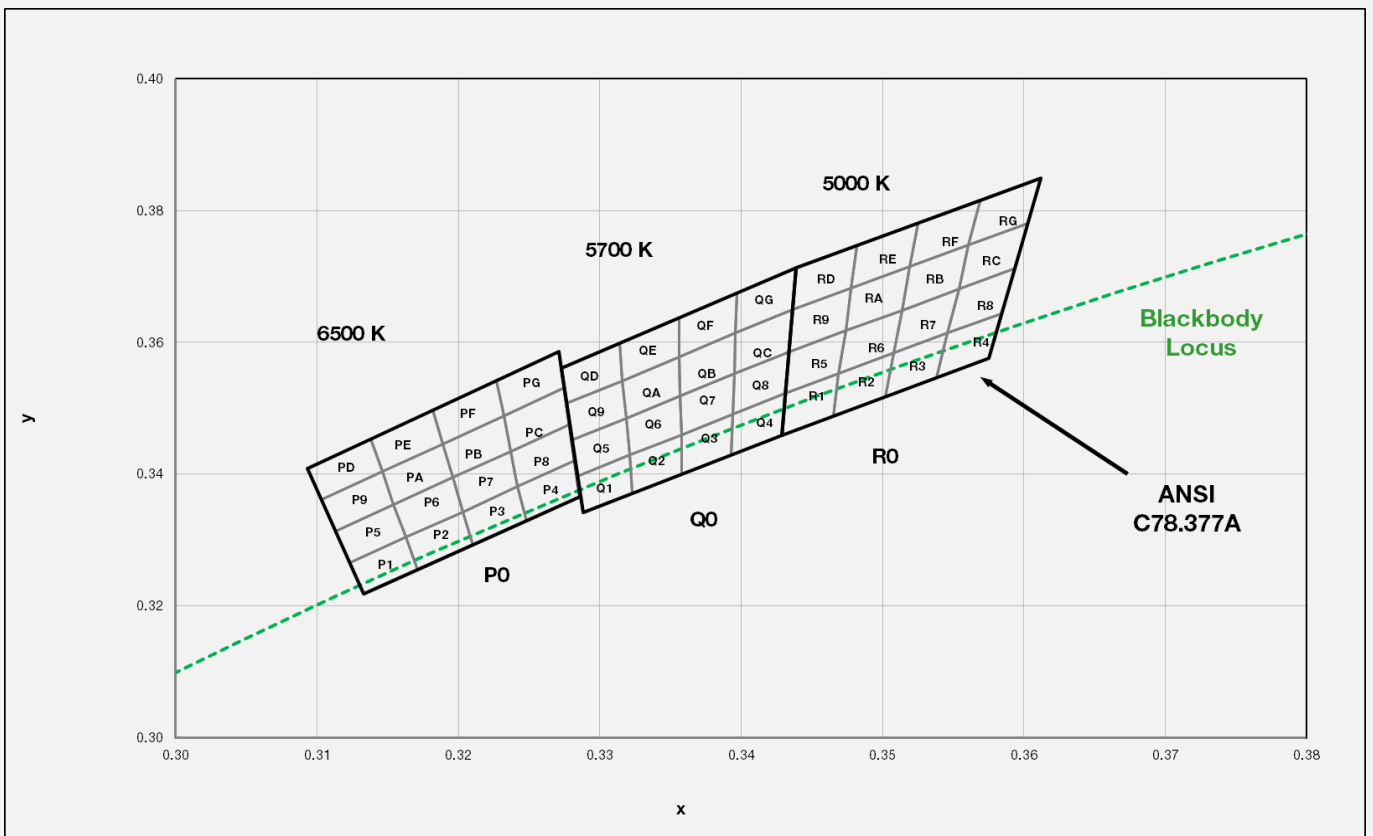
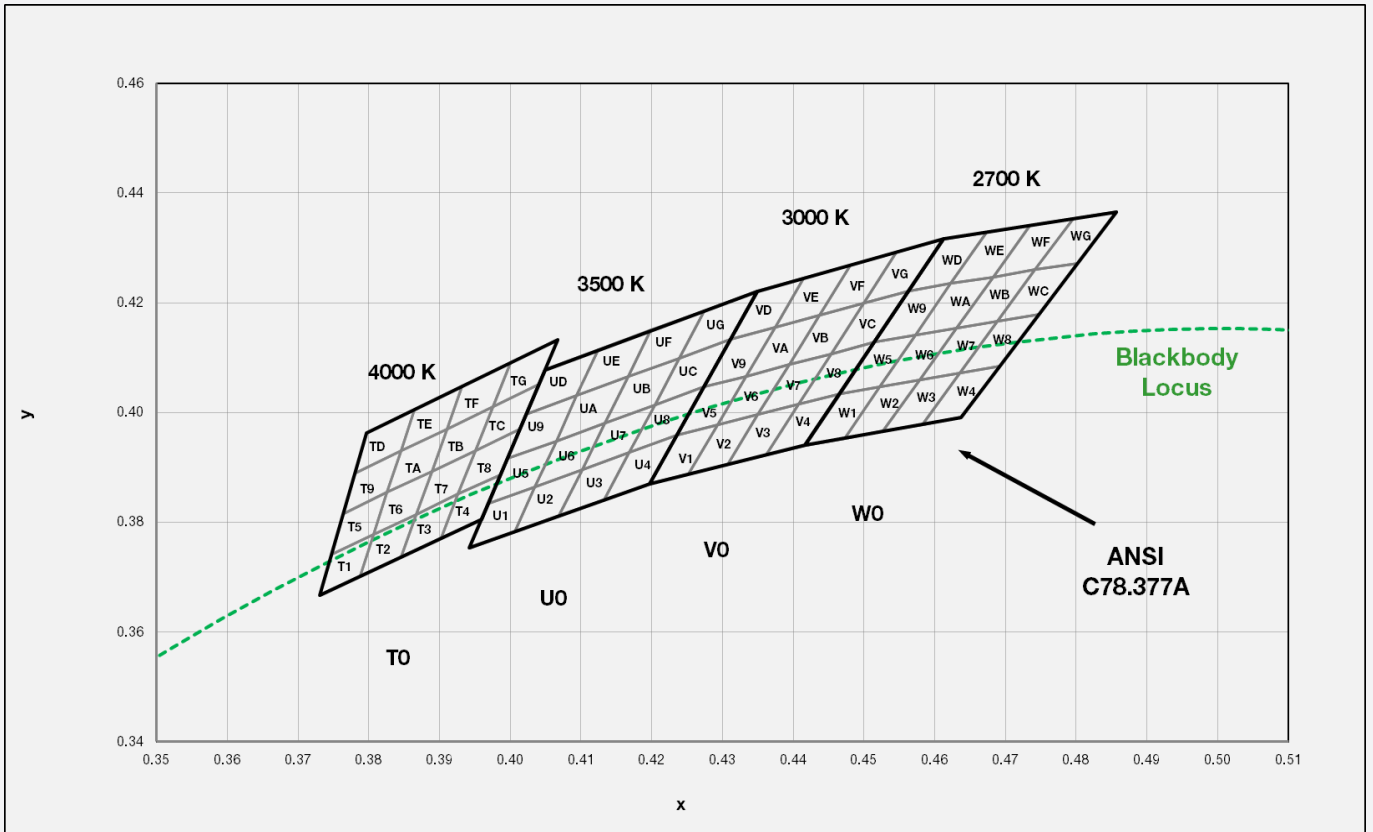

e) Chromaticity Region & Coordinates

Region	CIE x	CIE y	Region	CIE x	CIE y
W rank (2700 K)					
W1	0.4417	0.3940	W9	0.4515	0.4128
	0.4472	0.3953		0.4573	0.4141
	0.4522	0.4047		0.4623	0.4235
	0.4466	0.4034		0.4563	0.4222
W2	0.4472	0.3953	WA	0.4573	0.4141
	0.4527	0.3966		0.4631	0.4153
	0.4579	0.4059		0.4683	0.4247
	0.4522	0.4047		0.4623	0.4235
W3	0.4527	0.3966	WB	0.4631	0.4153
	0.4582	0.3978		0.4689	0.4166
	0.4635	0.4072		0.4742	0.4260
	0.4579	0.4059		0.4683	0.4247
W4	0.4582	0.3978	WC	0.4689	0.4166
	0.4637	0.3991		0.4747	0.4179
	0.4692	0.4085		0.4802	0.4272
	0.4635	0.4072		0.4742	0.4260
W5	0.4466	0.4034	WD	0.4563	0.4222
	0.4522	0.4047		0.4623	0.4235
	0.4573	0.4141		0.4673	0.4329
	0.4515	0.4128		0.4612	0.4316
W6	0.4522	0.4047	WE	0.4623	0.4235
	0.4579	0.4059		0.4683	0.4247
	0.4631	0.4153		0.4735	0.4341
	0.4573	0.4141		0.4673	0.4329
W7	0.4579	0.4059	WF	0.4683	0.4247
	0.4635	0.4072		0.4742	0.4260
	0.4689	0.4166		0.4796	0.4354
	0.4631	0.4153		0.4735	0.4341
W8	0.4635	0.4072	WG	0.4742	0.4260
	0.4692	0.4085		0.4802	0.4272
	0.4747	0.4179		0.4857	0.4366
	0.4689	0.4166		0.4796	0.4354

Region	CIE x	CIE y	Region	CIE x	CIE y
V rank (3000 K)					
V1	0.4197	0.3870	V9	0.4273	0.4046
	0.4252	0.3888		0.4333	0.4066
	0.4293	0.3977		0.4374	0.4155
	0.4235	0.3958		0.4311	0.4133
V2	0.4252	0.3888	VA	0.4333	0.4066
	0.4307	0.3905		0.4394	0.4087
	0.4350	0.3996		0.4437	0.4178
	0.4293	0.3977		0.4374	0.4155
V3	0.4307	0.3905	VB	0.4394	0.4087
	0.4362	0.3923		0.4454	0.4107
	0.4408	0.4015		0.4500	0.4200
	0.4350	0.3996		0.4437	0.4178
V4	0.4362	0.3923	VC	0.4454	0.4107
	0.4417	0.3940		0.4515	0.4128
	0.4466	0.4034		0.4563	0.4222
	0.4408	0.4015		0.4500	0.4200
V5	0.4235	0.3958	VD	0.4311	0.4133
	0.4293	0.3977		0.4374	0.4155
	0.4333	0.4066		0.4415	0.4245
	0.4273	0.4046		0.4349	0.4221
V6	0.4293	0.3977	VE	0.4374	0.4155
	0.4350	0.3996		0.4437	0.4178
	0.4394	0.4087		0.4481	0.4269
	0.4333	0.4066		0.4415	0.4245
V7	0.4350	0.3996	VF	0.4437	0.4178
	0.4408	0.4015		0.4500	0.4200
	0.4454	0.4107		0.4546	0.4292
	0.4394	0.4087		0.4481	0.4269
V8	0.4408	0.4015	VG	0.4500	0.4200
	0.4466	0.4034		0.4563	0.4222
	0.4515	0.4128		0.4612	0.4316
	0.4454	0.4107		0.4546	0.4292

e) Chromaticity Region & Coordinates

Region	CIE x	CIE y	Region	CIE x	CIE y
U rank (3500 K)					
U1	0.3942	0.3753	U9	0.3995	0.3916
	0.4006	0.3782		0.4065	0.3948
	0.4035	0.3865		0.4094	0.4031
	0.3969	0.3834		0.4022	0.3997
U2	0.4006	0.3782	UA	0.4065	0.3948
	0.4069	0.3812		0.4134	0.3981
	0.4102	0.3896		0.4167	0.4065
	0.4035	0.3865		0.4094	0.4031
U3	0.4069	0.3812	UB	0.4134	0.3981
	0.4133	0.3841		0.4204	0.4013
	0.4168	0.3927		0.4239	0.4099
	0.4102	0.3896		0.4167	0.4065
U4	0.4133	0.3841	UC	0.4204	0.4013
	0.4197	0.3870		0.4273	0.4046
	0.4235	0.3958		0.4311	0.4133
	0.4168	0.3927		0.4239	0.4099
U5	0.3969	0.3834	UD	0.4022	0.3997
	0.4035	0.3865		0.4094	0.4031
	0.4065	0.3948		0.4124	0.4114
	0.3995	0.3916		0.4049	0.4078
U6	0.4035	0.3865	UE	0.4094	0.4031
	0.4102	0.3896		0.4167	0.4065
	0.4134	0.3981		0.4199	0.4150
	0.4065	0.3948		0.4124	0.4114
U7	0.4102	0.3896	UF	0.4167	0.4065
	0.4168	0.3927		0.4239	0.4099
	0.4204	0.4013		0.4274	0.4185
	0.4134	0.3981		0.4199	0.4150
U8	0.4168	0.3927	UG	0.4239	0.4099
	0.4235	0.3958		0.4311	0.4133
	0.4273	0.4046		0.4349	0.4221
	0.4204	0.4013		0.4274	0.4185

Region	CIE x	CIE y	Region	CIE x	CIE y
T rank (4000 K)					
T1	0.3731	0.3667	T9	0.3764	0.3815
	0.3788	0.3702		0.3826	0.3854
	0.3807	0.3778		0.3845	0.3930
	0.3748	0.3741		0.3781	0.3889
T2	0.3788	0.3702	TA	0.3826	0.3854
	0.3845	0.3736		0.3889	0.3892
	0.3867	0.3814		0.3910	0.3970
	0.3807	0.3778		0.3845	0.3930
T3	0.3845	0.3736	TB	0.3889	0.3892
	0.3902	0.3771		0.3951	0.3931
	0.3926	0.3851		0.3975	0.4011
	0.3867	0.3814		0.3910	0.3970
T4	0.3902	0.3771	TC	0.3951	0.3931
	0.3959	0.3805		0.4013	0.3969
	0.3986	0.3887		0.4040	0.4051
	0.3926	0.3851		0.3975	0.4011
T5	0.3748	0.3741	TD	0.3781	0.3889
	0.3807	0.3778		0.3845	0.3930
	0.3826	0.3854		0.3865	0.4006
	0.3764	0.3815		0.3797	0.3963
T6	0.3807	0.3778	TE	0.3845	0.3930
	0.3867	0.3814		0.3910	0.3970
	0.3889	0.3892		0.3932	0.4048
	0.3826	0.3854		0.3865	0.4006
T7	0.3867	0.3814	TF	0.3910	0.3970
	0.3926	0.3851		0.3975	0.4011
	0.3951	0.3931		0.4000	0.4091
	0.3889	0.3892		0.3932	0.4048
T8	0.3926	0.3851	TG	0.3975	0.4011
	0.3986	0.3887		0.4040	0.4051
	0.4013	0.3969		0.4067	0.4133
	0.3951	0.3931		0.4000	0.4091

e) Chromaticity Region & Coordinates

Region	CIE x	CIE y	Region	CIE x	CIE y
R rank (5000 K)					
R1	0.3429	0.3459	R9	0.3434	0.3586
	0.3465	0.3489		0.3474	0.3618
	0.3469	0.3553		0.3478	0.3682
	0.3431	0.3523		0.3436	0.3650
R2	0.3465	0.3489	RA	0.3474	0.3618
	0.3502	0.3518		0.3514	0.3649
	0.3508	0.3584		0.3519	0.3715
	0.3469	0.3553		0.3478	0.3682
R3	0.3502	0.3518	RB	0.3514	0.3649
	0.3538	0.3547		0.3554	0.3681
	0.3546	0.3614		0.3561	0.3748
	0.3508	0.3584		0.3519	0.3715
R4	0.3538	0.3547	RC	0.3554	0.3681
	0.3575	0.3576		0.3594	0.3713
	0.3584	0.3644		0.3603	0.3781
	0.3546	0.3614		0.3561	0.3748
R5	0.3431	0.3523	RD	0.3436	0.3650
	0.3469	0.3553		0.3478	0.3682
	0.3474	0.3618		0.3482	0.3747
	0.3434	0.3586		0.3439	0.3713
R6	0.3469	0.3553	RE	0.3478	0.3682
	0.3508	0.3584		0.3519	0.3715
	0.3514	0.3649		0.3525	0.3781
	0.3474	0.3618		0.3482	0.3747
R7	0.3508	0.3584	RF	0.3519	0.3715
	0.3546	0.3614		0.3561	0.3748
	0.3554	0.3681		0.3569	0.3815
	0.3514	0.3649		0.3525	0.3781
R8	0.3546	0.3614	RG	0.3561	0.3748
	0.3584	0.3644		0.3603	0.3781
	0.3594	0.3713		0.3612	0.3849
	0.3554	0.3681		0.3569	0.3815

Region	CIE x	CIE y	Region	CIE x	CIE y
Q rank (5700 K)					
Q1	0.3288	0.3342	Q9	0.3280	0.3452
	0.3323	0.3372		0.3319	0.3485
	0.3321	0.3429		0.3316	0.3542
	0.3284	0.3397		0.3276	0.3507
Q2	0.3323	0.3372	QA	0.3319	0.3485
	0.3358	0.3401		0.3357	0.3519
	0.3358	0.3460		0.3356	0.3578
	0.3321	0.3429		0.3316	0.3542
Q3	0.3358	0.3401	QB	0.3357	0.3519
	0.3393	0.3430		0.3395	0.3553
	0.3394	0.3491		0.3396	0.3614
	0.3358	0.3460		0.3356	0.3578
Q4	0.3393	0.3430	QC	0.3395	0.3553
	0.3429	0.3459		0.3434	0.3586
	0.3431	0.3523		0.3436	0.3650
	0.3394	0.3491		0.3396	0.3614
Q5	0.3284	0.3397	QD	0.3276	0.3507
	0.3321	0.3429		0.3316	0.3542
	0.3319	0.3485		0.3314	0.3599
	0.3280	0.3452		0.3273	0.3561
Q6	0.3321	0.3429	QE	0.3316	0.3542
	0.3358	0.3460		0.3356	0.3578
	0.3357	0.3519		0.3356	0.3637
	0.3319	0.3485		0.3314	0.3599
Q7	0.3358	0.3460	QF	0.3356	0.3578
	0.3394	0.3491		0.3396	0.3614
	0.3395	0.3553		0.3397	0.3675
	0.3357	0.3519		0.3356	0.3637
Q8	0.3394	0.3491	QG	0.3396	0.3614
	0.3431	0.3523		0.3436	0.3650
	0.3434	0.3586		0.3439	0.3713
	0.3395	0.3553		0.3397	0.3675

e) Chromaticity Region & Coordinates

Region	CIE x	CIE y	Region	CIE x	CIE y
P rank (6500 K)					
P1	0.3133	0.3218	P9	0.3113	0.3314
	0.3171	0.3255		0.3154	0.3354
	0.3163	0.3305		0.3146	0.3404
	0.3123	0.3266		0.3103	0.3361
P2	0.3171	0.3255	PA	0.3154	0.3354
	0.3210	0.3292		0.3196	0.3395
	0.3203	0.3343		0.3189	0.3446
	0.3163	0.3305		0.3146	0.3404
P3	0.3210	0.3292	PB	0.3196	0.3395
	0.3248	0.3329		0.3237	0.3435
	0.3242	0.3382		0.3232	0.3489
	0.3203	0.3343		0.3189	0.3446
P4	0.3248	0.3329	PC	0.3237	0.3435
	0.3286	0.3366		0.3279	0.3476
	0.3282	0.3421		0.3275	0.3531
	0.3242	0.3382		0.3232	0.3489
P5	0.3123	0.3266	PD	0.3103	0.3361
	0.3163	0.3305		0.3146	0.3404
	0.3154	0.3354		0.3138	0.3453
	0.3113	0.3314		0.3093	0.3409
P6	0.3163	0.3305	PE	0.3146	0.3404
	0.3203	0.3343		0.3189	0.3446
	0.3196	0.3395		0.3182	0.3498
	0.3154	0.3354		0.3138	0.3453
P7	0.3203	0.3343	PF	0.3189	0.3446
	0.3242	0.3382		0.3232	0.3489
	0.3237	0.3435		0.3227	0.3542
	0.3196	0.3395		0.3182	0.3498
P8	0.3242	0.3382	PG	0.3232	0.3489
	0.3282	0.3421		0.3275	0.3531
	0.3279	0.3476		0.3271	0.3586
	0.3237	0.3435		0.3227	0.3542

Note: Samsung maintains measurement tolerance of: Cx, Cy = ±0.005

3. Typical Characteristics Graphs

a) Spectrum Distribution ($I_f = 100 \text{ mA}$, $T_s = 25 \text{ }^\circ\text{C}$)

CCT: 2700 K (90 CRI)

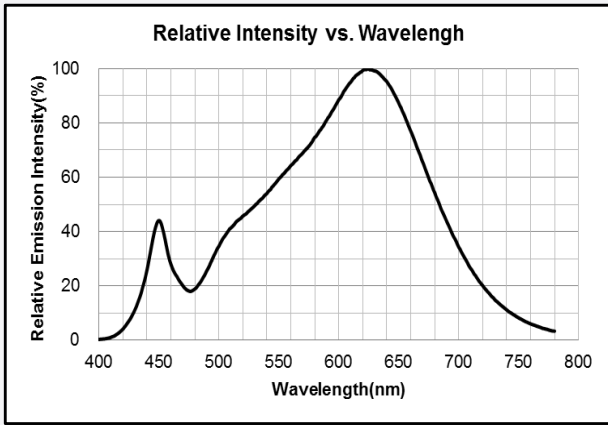

CCT: 3000 K (90 CRI)

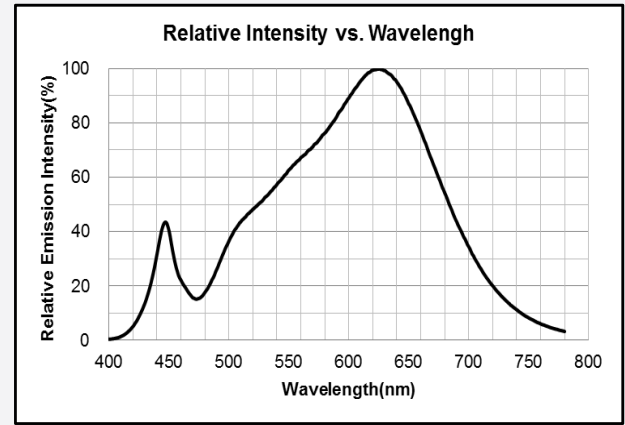

CCT: 3500 K (90 CRI)

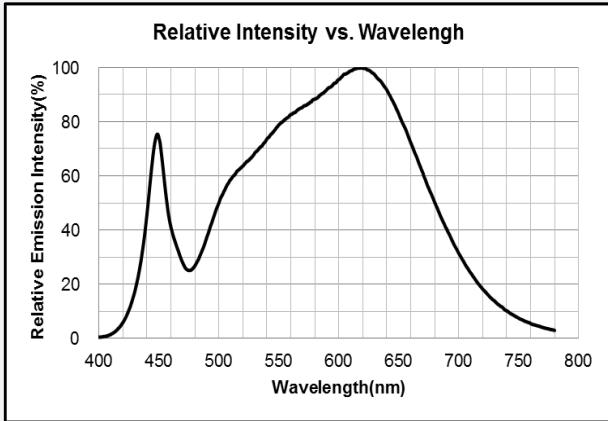

CCT: 4000 K (90 CRI)

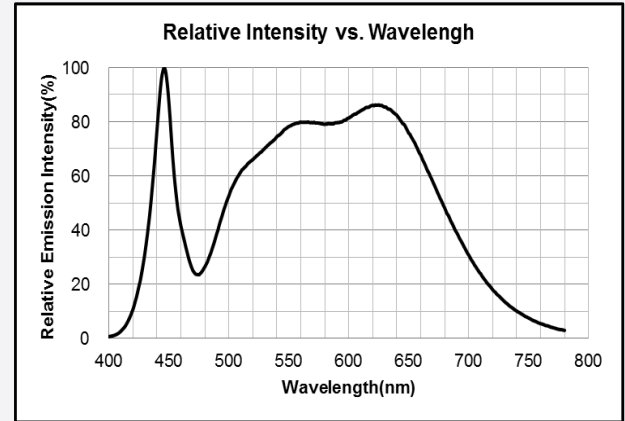

CCT: 5000 K (90 CRI)

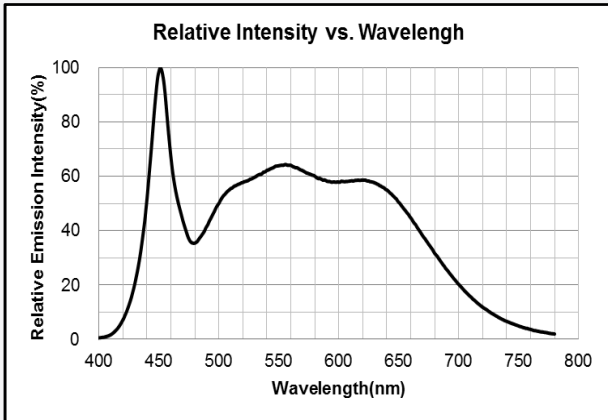

CCT: 5700 K (90 CRI)

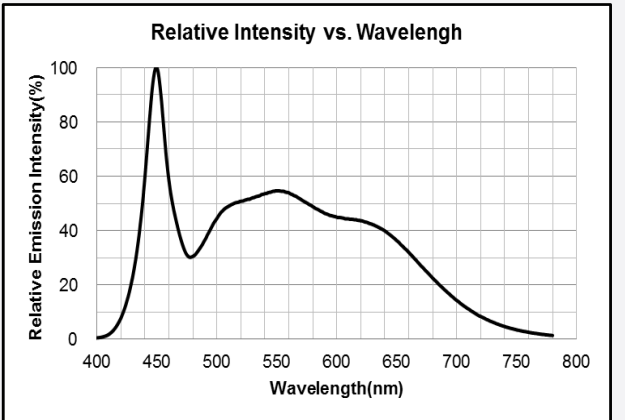

CCT: 6500 K (90 CRI)

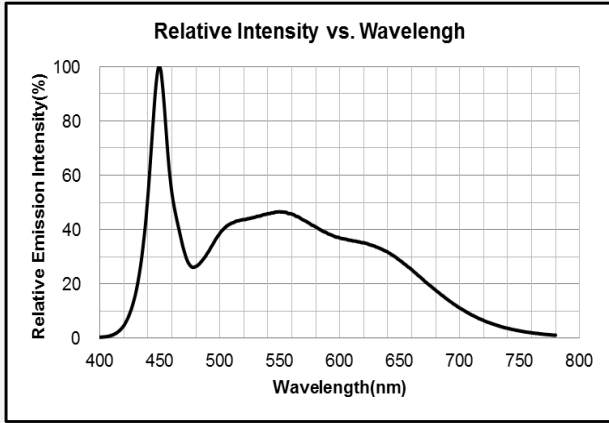

b) Forward Current Characteristics (T_s = 25 °C)

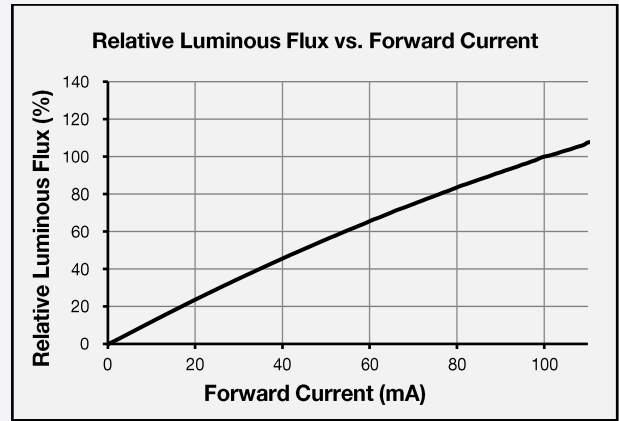
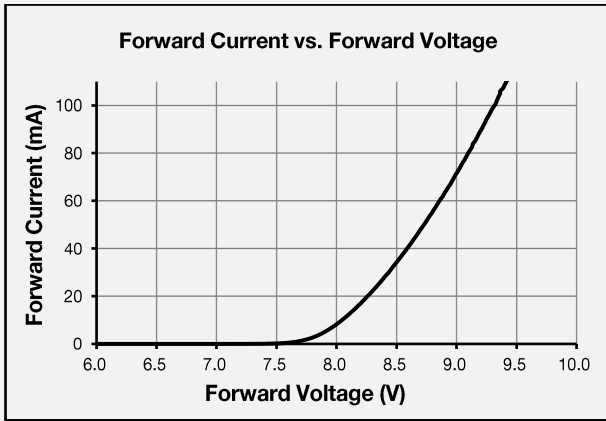

c) Temperature Characteristics (I_F = 100 mA)

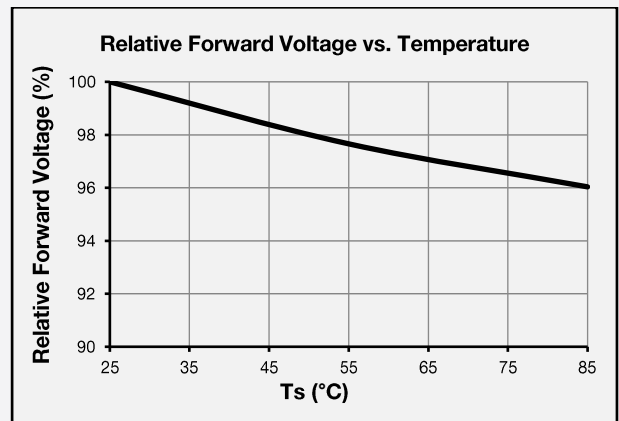
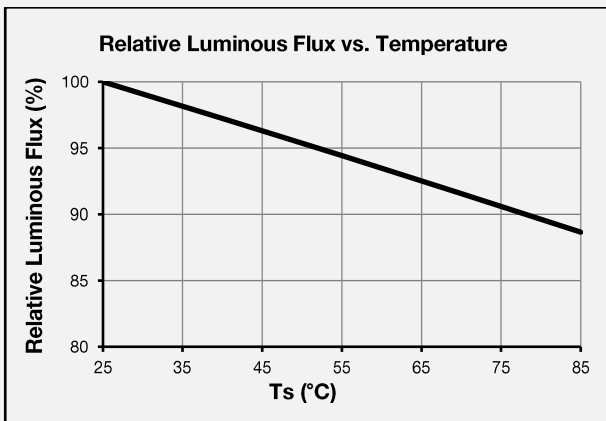

d) Color Shift Characteristics ($I_F = 100 \text{ mA}$, $T_s = 25 \text{ }^\circ\text{C}$)

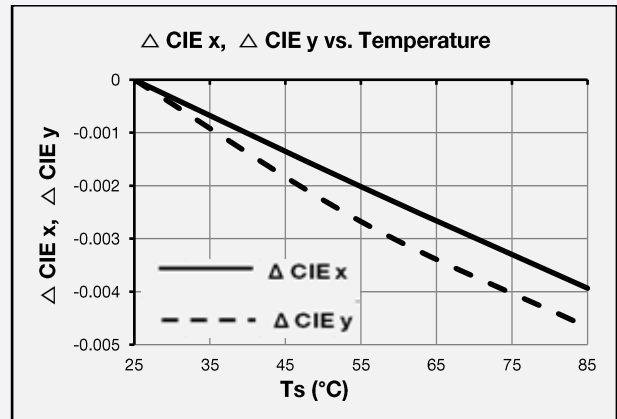
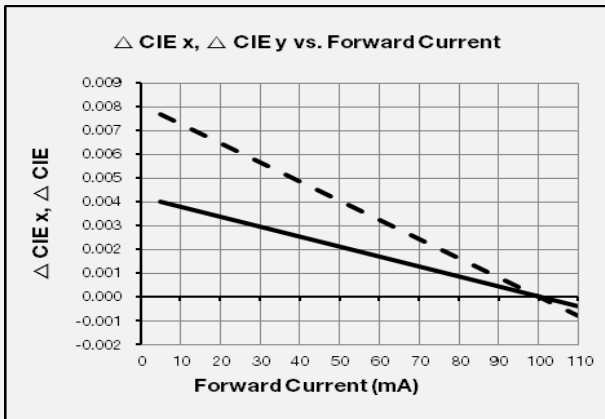

e) Derating Curve

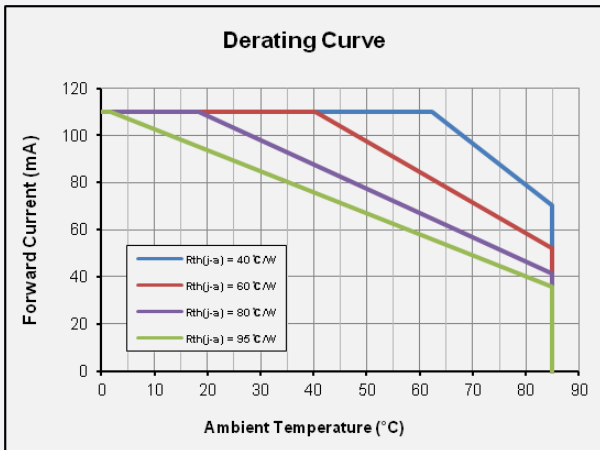

f) Beam Angle Characteristics ($I_F = 100 \text{ mA}$, $T_s = 25 \text{ }^\circ\text{C}$)

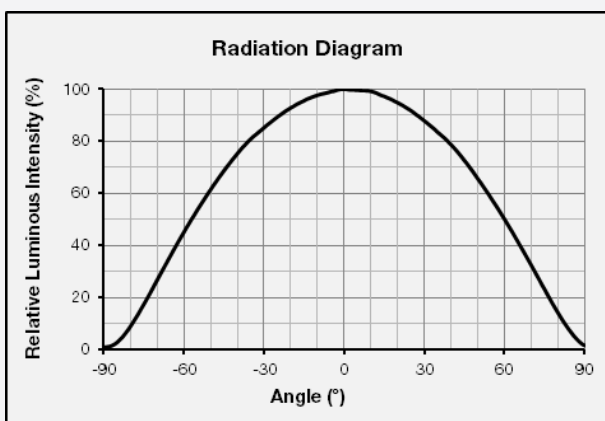

4. Outline Drawing & Dimension

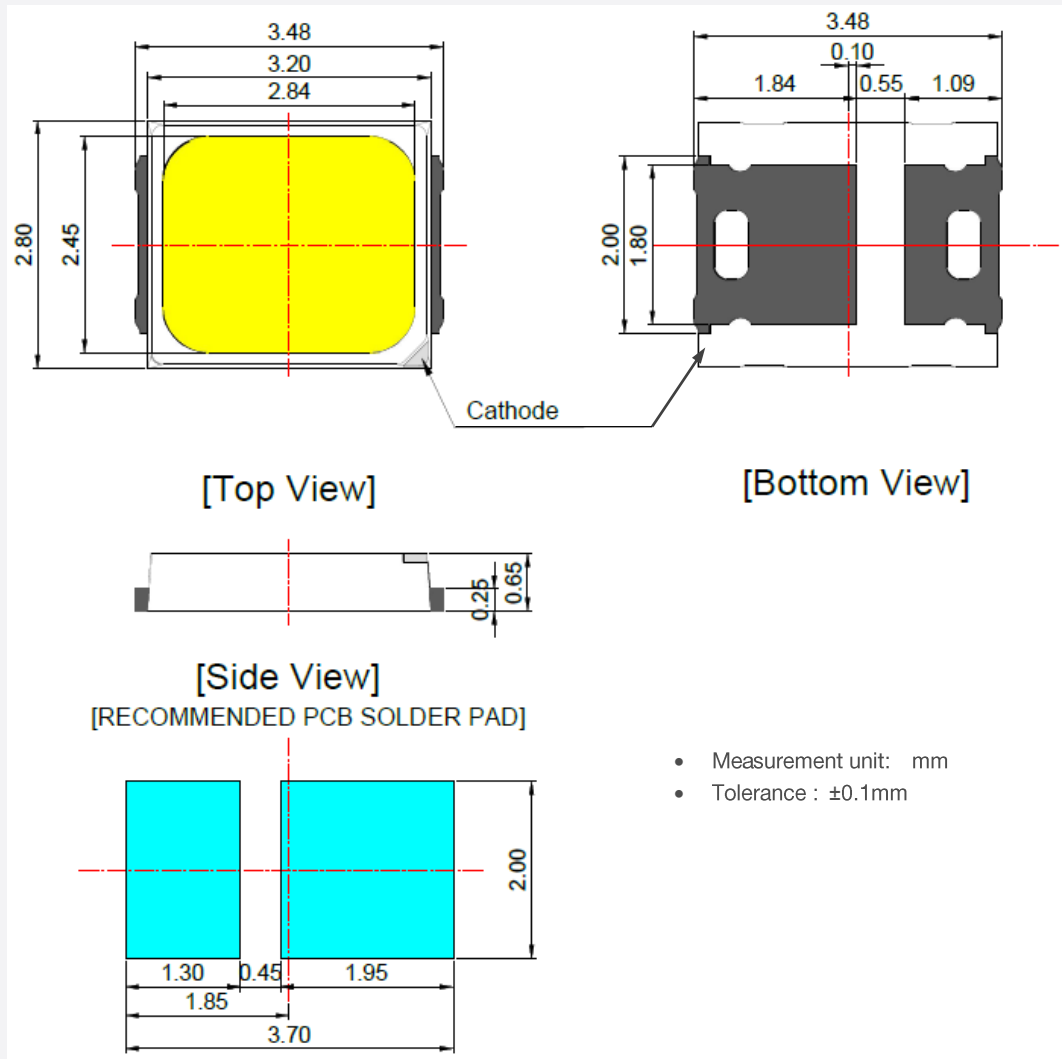

Notes:

- 1) T_s point and measurement method:
 - ① Measure one point at the cathode pad, if necessary remove PSR of PCB to reach T_s point.
 - ② All pads must be soldered to the PCB to dissipate heat properly, otherwise the LED can be damaged.

Precautions:

- 1) Pressure on the LEDs will influence to the reliability of the LEDs. Precautions should be taken to avoid strong pressure on the LEDs. Do not put stress on the LEDs during heating.
- 2) Re-soldering should not be done after the LEDs have been soldered. If re-soldering is unavoidable, LED's characteristics should be carefully checked before and after such repair.
- 3) Do not stack assembled PCBs together. Since materials of LEDs is soft, abrasion between two PCB assembled with LED might cause catastrophic failure of the LEDs.

5. Reliability Test Items & Conditions

a) Test Items

Test Item	Test Condition	Test Hour / Cycle	Sample No.
Room Temperature Life Test	25 °C, DC 110 mA	1000 h	22
High Temperature Life Test	85 °C, DC 110 mA	1000 h	22
High Temperature Humidity Life Test	60 °C, 90 % RH, DC 110 mA	1000 h	22
Low Temperature Life Test	-40 °C, DC 110 mA	1000 h	22
Powered Temperature Cycle Test	-45 °C ~ 85 °C, each 20 min, on/off 5 min Temp. Change time 100min, DC 110 mA	100 cycles	22
Temperature Cycling	-45 °C / 15 min ↔ 125 °C / 15 min	200 cycles	100
High Temperature Storage	85 °C	1000 h	11
Low Temperature Storage	-40 °C	1000 h	11

ESD (HBM)

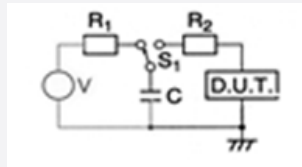

R_1 : 10 M Ω
 R_2 : 1.5 k Ω
 C : 100 pF
 V : ± 2 kV

5 times

30

b) Criteria for Judging the Damage

Item	Symbol	Test Condition ($T_s = 25^\circ\text{C}$)	Limit	
			Min	Max
Forward Voltage	V_F	$I_F = 100$ mA	Init. Value * 0.9	Init. Value * 1.1
Luminous Flux	Φ_v	$I_F = 100$ mA	Init. Value * 0.7	Init. Value * 1.1

6. Soldering Conditions

a) Reflow Conditions (Pb free)

Reflow frequency: 2 times max.

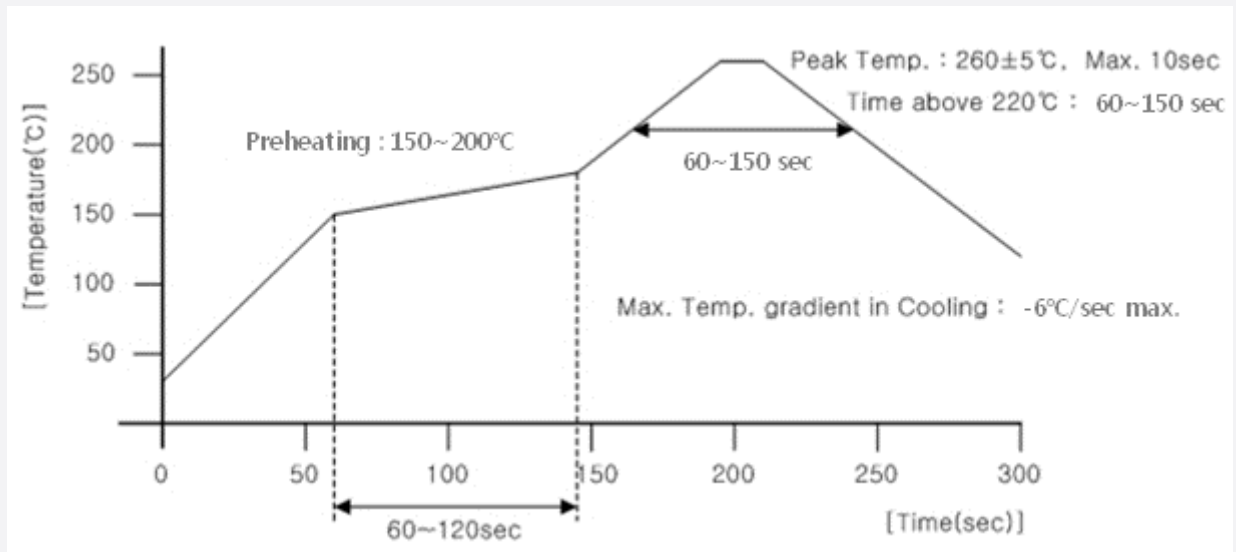

b) Manual Soldering Conditions

Not more than 5 seconds @ max. 300°C , under soldering iron.

7. Tape & Reel

a) Taping Dimension

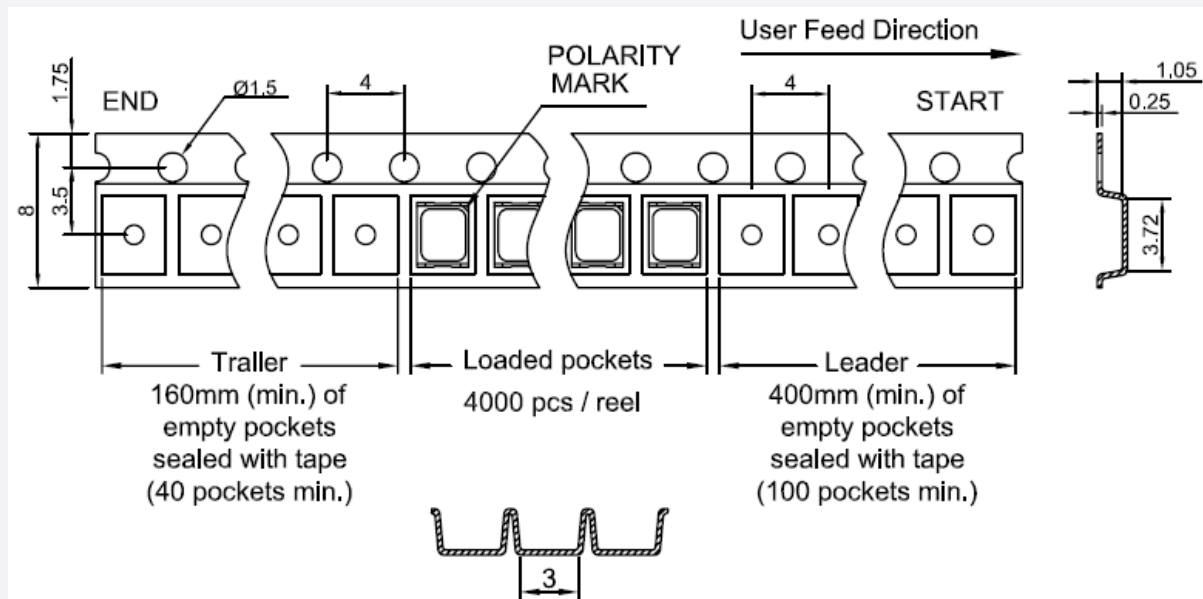

b) Reel Dimension (max 4,000 pcs)

(unit: mm)

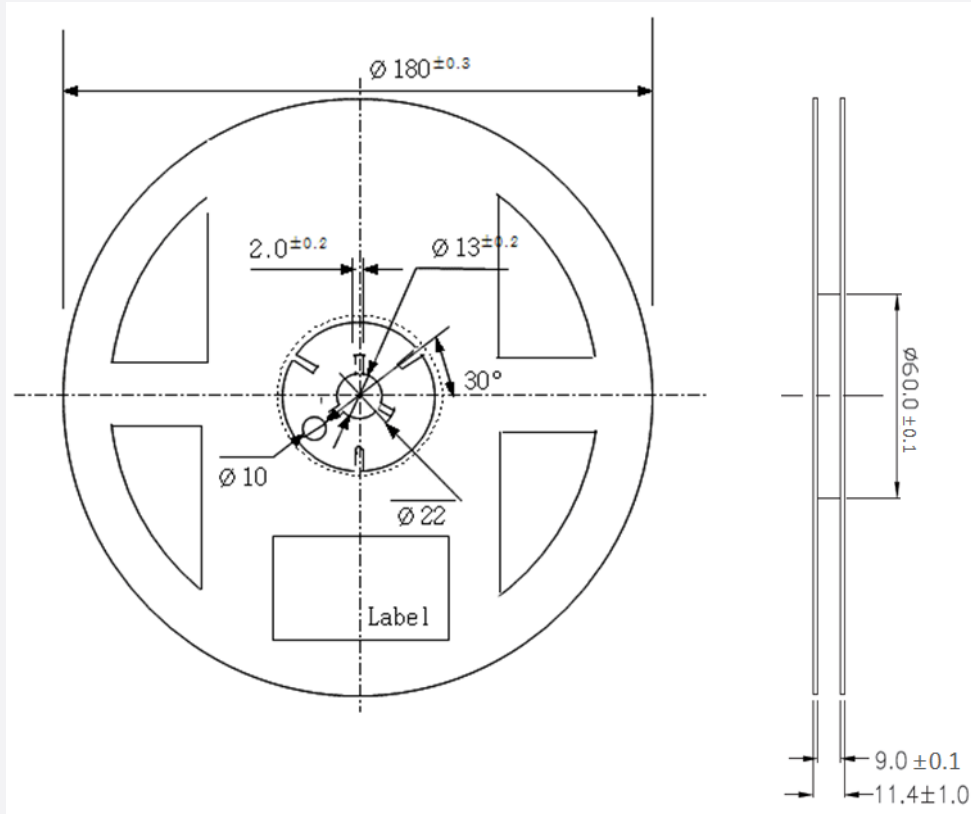
**Notes:**

- 1) Quantity: The quantity/reel is 4,000 pcs
- 2) All dimensions are millimeters (tolerance : ± 0.2 mm)
- 3) Packaging: P/N, Manufacturing data code no. and quantity are indicated on the aluminum packing bag

c) Reel Dimension (max 16,000 pcs)

(unit: mm)

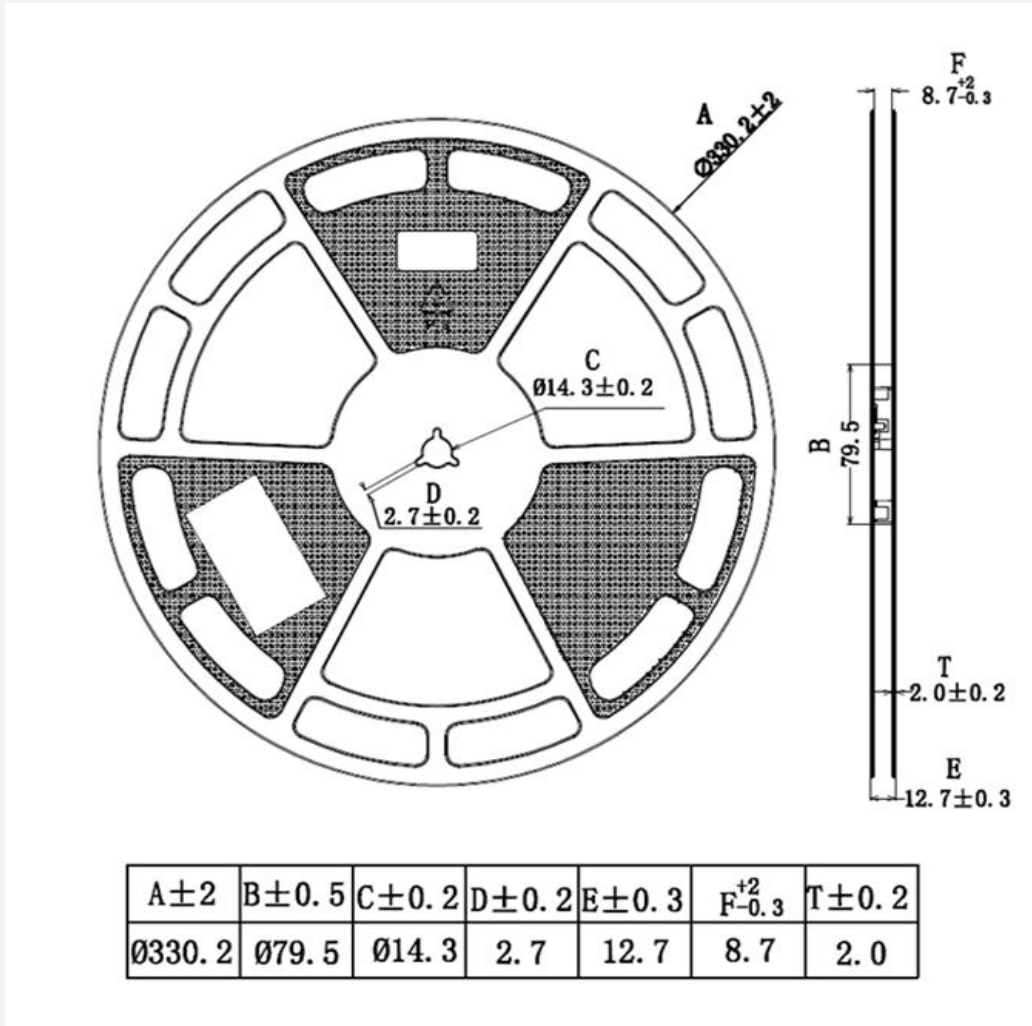

Notes:

- 1) Quantity: The quantity/reel is 16,000 pcs
- 2) All dimensions are millimeters (tolerance : $\pm 0.2\text{mm}$)
- 3) Packaging: P/N, Manufacturing data code no. and quantity are indicated on the aluminum packing bag

8. Label Structure

a) Label Structure

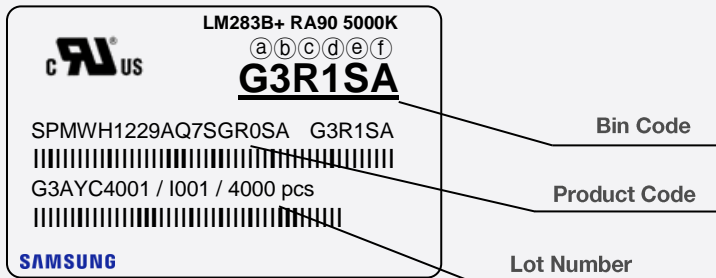

Note: Denoted bin code and product code above is only an example (see description on page 6)

Bin Code:

- ⒶⒷ: Forward Voltage bin (refer to page 10)
- ⒸⒹ: Chromaticity bin (refer to page 8-15)
- ⒺⒻ: Luminous Flux bin (refer to page 7)

b) Lot Number

The lot number is composed of the following characters:



①②③④⑤⑥⑦⑧⑨ / IⒶⒷⒸ / 4,000 pcs

- ①② : Production site (G3 or GP : Shenzhen, China)
- ③ : Product state (A: Normal, B: Bulk, C: First Production, R: Reproduction, S: Sample)
- ④ : Year (Z: 2015, A: 2016, B: 2017...)
- ⑤ : Month (1~9, A, B, C)
- ⑥ : Day (1~9, A, B~V)
- ⑦⑧⑨ ⒶⒷⒸ : Product serial number

9. Packing Structure

a) Packing Process (The quantity of PKG on the Reel to be Max 4,000 pcs)

Reel

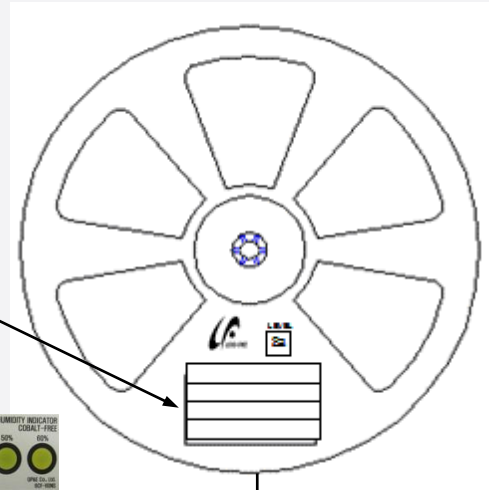
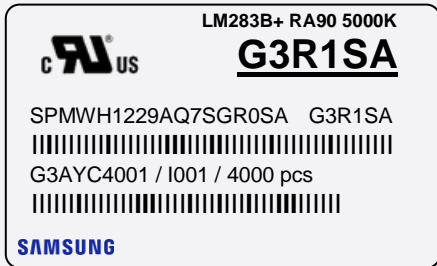

Aluminum Vinyl Packing Bag

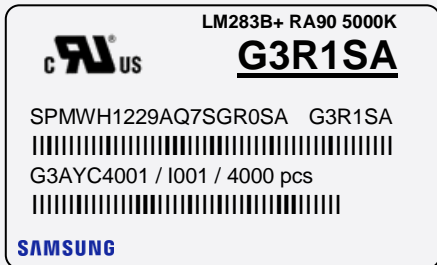

Outer Box

Material: Paper (SW3B(B))

Type	Size (mm)			Note
	L	W	H	
7 inch L	245 ± 5	220 ± 5	182 ± 5	Up to 10 reels
7 inch S	245 ± 5	220 ± 5	86 ± 5	Up to 5 reels

① Side Label

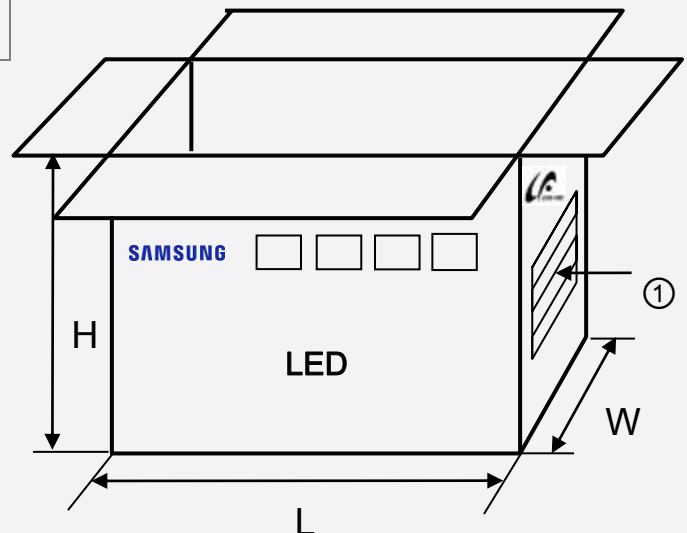
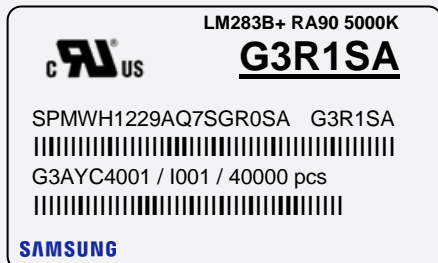

b) Packing Process (The quantity of PKG on the Reel to be Max 16,000 pcs)

Reel

LM283B+ RA90 5000K
G3R1SA
 SPMWH1229AQ7SKR0SA G3R1SA
 G3AYC4001 / IOAA / 16000 pcs
SAMSUNG

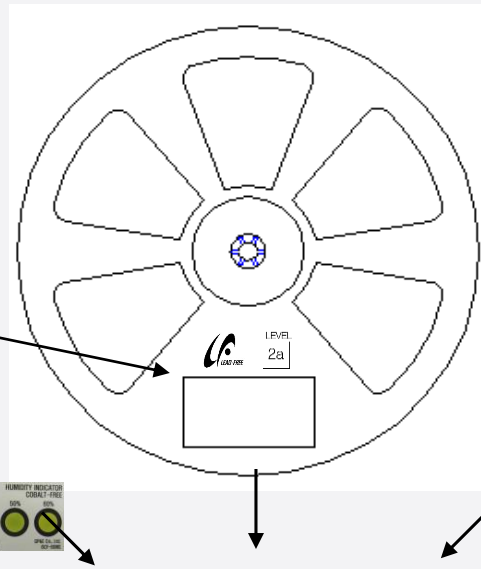

Aluminum Vinyl Packing Bag

LM283B+ RA90 5000K
G3R1SA
 SPMWH1229AQ7SKR0SA G3R1SA
 G3AYC4001 / IOAA / 16000 pcs
SAMSUNG

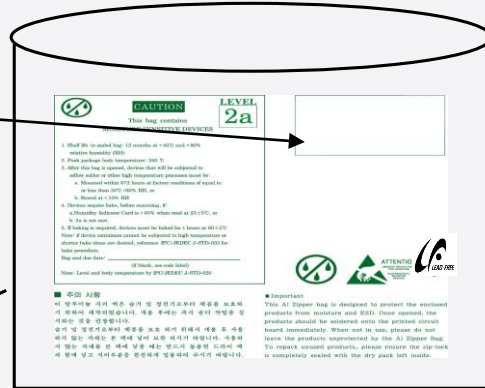

Outer Box

LM283B+ RA90 5000K
G3R1SA
 SPMWH1229AQ7SKR0SA G3R1SA
 G3AYC4001 / IOAA / 480000 pcs
SAMSUNG

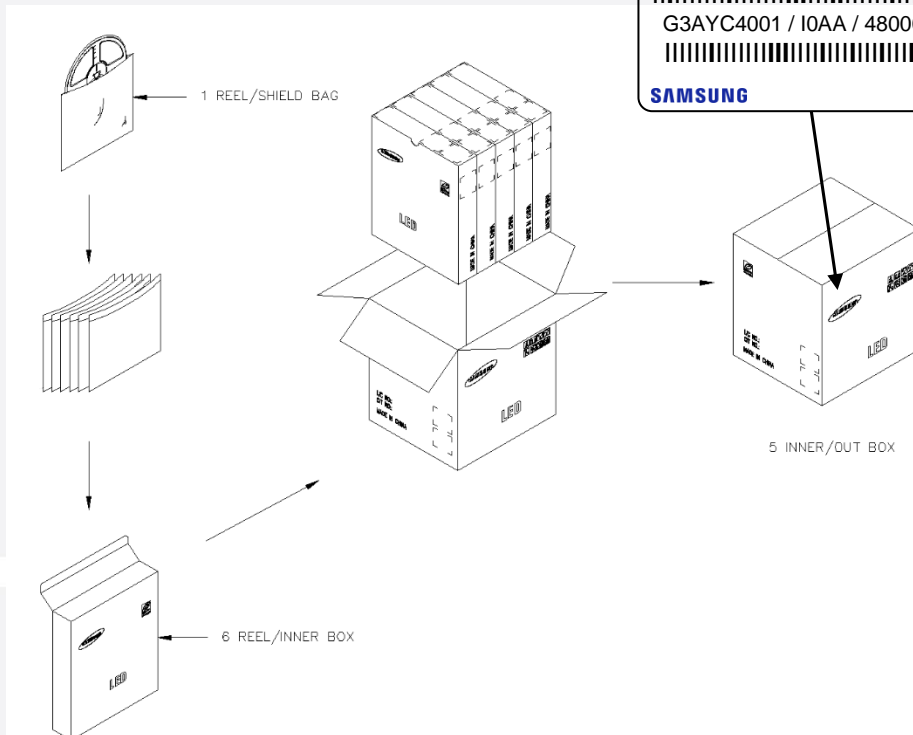

c) Packing Process

Reel

Kitting 'A'

LM283B+ RA90 ★K
G3★1SA
 SPMWH1229AQ7SG★KSA G3★1SA
 G3AW94001 / I0AA / 4000 pcs
SAMSUNG

Kitting 'B'

LM283B+ RA90 ★K
G3★CSA
 SPMWH1229AQ7SG★KSA G3★CSA
 G3AW94001 / I0AA / 4000 pcs
SAMSUNG

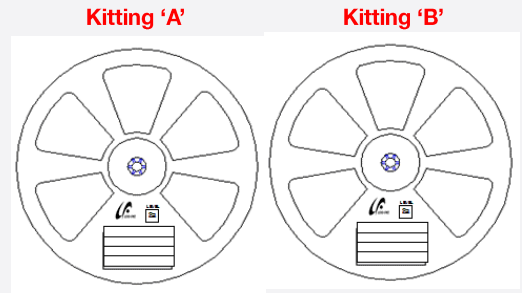

Aluminum Vinyl Packing Bag

Kitting 'A'

LM283B+ RA90 ★K
G3★1SA
 SPMWH1229AQ7SG★KSA G3★1SA
 G3AW94001 / I0AA / 4000 pcs
SAMSUNG

Kitting 'B'

LM283B+ RA90 ★K
G3★CSA
 SPMWH1229AQ7SG★KSA G3★CSA
 G3AW94001 / I0AA / 4000 pcs
SAMSUNG

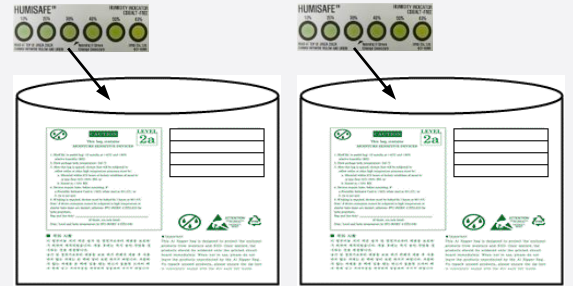

Outer Box

Kitting 'A'

LM283B+ RA90 ★K
G3★1SA
 SPMWH1229AQ7SG★KSA G3★1SA
 G3AW94001 / I0AA / 20000 pcs
SAMSUNG [BOX Label]

Kitting 'B'

LM283B+ RA90 ★K
G3★CSA
 SPMWH1229AQ7SG★KSA G3★CSA
 G3AW94001 / I0AA / 20000 pcs
SAMSUNG [BOX Label]

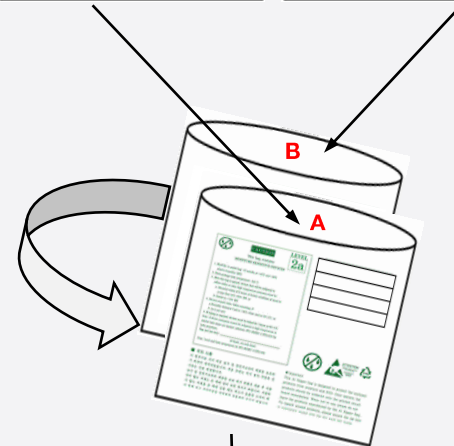

Material: Paper (SW3B(B))

Type	Size (mm)			Note
	L	W	H	
13 inch L	345 ± 5	378 ± 5	405 ± 5	Up to 10 reels

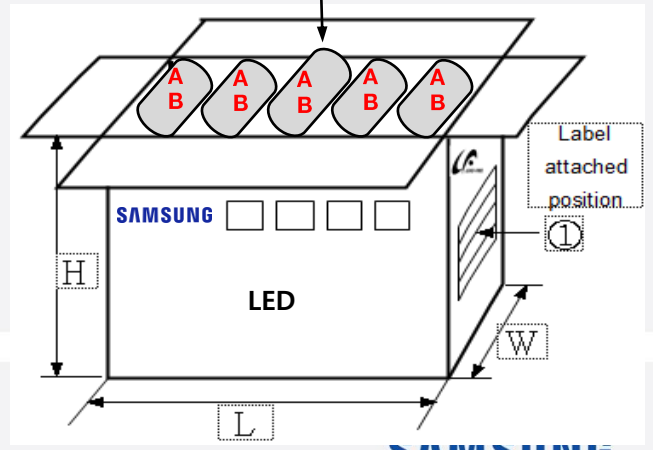

c) Aluminum Vinyl Packing Bag



CAUTION

This bag contains
MOISTURE SENSITIVE DEVICES

LEVEL
2a

1. Shelf life in sealed bag: 12 months at <40°C and <90% relative humidity (RH)
2. Peak package body temperature: 240 °C
3. After this bag is opened, devices that will be subjected to reflow solder or other high temperature processes must be:
 - a. Mounted within 672 hours at factory conditions of equal to or less than 30°C /60% RH, or
 - b. Stored at <10% RH
4. Devices require bake, before mounting, if:
 - a. Humidity Indicator Card is >/60% when read at 23±5°C, or
 - b. 2a is not met.
5. If baking is required, devices must be baked for 10 ~ 24 hours at 60±5°C

Note: If device containers cannot be subjected to high temperature or shorter bake times are desired, reference IPC/JEDEC J-STD-033 for bake procedure,

Bag seal due date: _____
(If blank, see code label)

Note: Level and body temperature by IPC/JEDEC J-STD-020

LM283B+ RA90 5000K



G3R1SA

SPMWH1229AQ7SGR0SA G3R1SA
 G3AYC4001 / I001 / 4,000 pcs

SAMSUNG







ATTENTION
OBSERVE PRECAUTIONS
FOR HANDLING
ELECTROSTATIC
SENSITIVE
DEVICES



OTHER

■ 주의 사항

이 알루미늄 지퍼 백은 습기 및 정전기로부터 제품을 보호하기 위하여 제작되었습니다. 개봉 후에는 즉시 솔더 작업을 실시하는 것을 권장합니다.

습기 및 정전기로부터 제품을 보호 하기 위해서 개봉 후 사용하지 않는 자재는 본 팩에 넣어 보관 하시기 바랍니다. 사용하지 않는 자재를 본 팩에 넣을 때는 반드시 동봉된 드라이 팩과 함께 넣고 지퍼부분을 완전하게 밀봉하여 주시기 바랍니다.

■ Important

This Al Zipper bag is designed to protect the enclosed products from moisture and ESD. Once opened, the products should be soldered onto the printed circuit board immediately. When not in use, please do not leave the products unprotected by the Al Zipper Bag. To repack unused products., please ensure the zip-lock is completely sealed with the dry pack left inside.

d) Humidity Indicator Card inside Aluminum Vinyl Bag

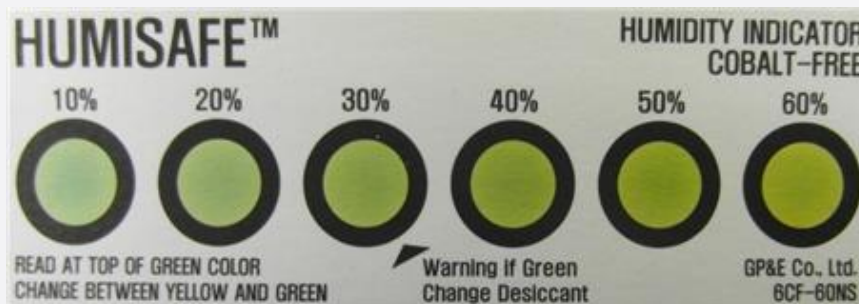

10. Precautions in Handling & Use

- 1) For over-current protection, users are recommended to apply resistors connected in series with the LEDs to mitigate sudden change of the forward current caused by shift of forward voltage.
- 2) This device should not be used in any type of fluid such as water, oil, organic solvent, etc. When cleaning is required, IPA is recommended as the cleaning agent. Some solvent-based cleaning agent may damage the silicone resins used in the device.
- 3) When the device is in operation, the forward current should be carefully determined considering the maximum ambient temperature and corresponding junction temperature.
- 4) LEDs must be stored in a clean environment. If the LEDs are to be stored for three months or more after being shipped from Samsung, they should be packed with a nitrogen-filled container (shelf life of sealed bags is 12 months at temperature 0~40 °C, 0~90 % RH).
- 5) After storage bag is opened, device subjected to soldering, solder reflow, or other high temperature processes must be:
 - a. Mounted within 672 hours (28 days) at an assembly line with a condition of no more than 30 °C / 60 % RH*^{Note 1}, or
 - b. Mounted within 24 hours (1 day) at an assembly line with a condition of more than 30 °C / 70 % RH*^{Note 2}, or
 - c. Stored at <10 % RH.

*Note 1, 2: IPC/JEDEC J-STD-033A, Recommended Equivalent Total Floor Life Table

Package Type and Body Thickness	Moisture Sensitivity Level	Maximum Percent Relative Humidity						Temperature
		40%	50%	60%	70%	80%	90%	
Body Thickness <2.1mm	Level 2a	∞	∞	28	1	1	1	30°C
		∞	∞	∞	2	1	1	25°C
		∞	∞	∞	2	2	1	20°C

- 6) Repack unused devices with anti-moisture packing, fold to close any opening and then store in a dry place.
- 7) Devices require baking before mounting, if humidity card reading is >60 % at 23 ± 5 °C.
- 8) Devices must be baked for 10~24 hours at 60 ± 5 °C, if baking is required.
- 9) The LEDs are sensitive to the static electricity and surge current. It is recommended to use a wrist band or anti-electrostatic glove when handling the LEDs. If voltage exceeding the absolute maximum rating is applied to LEDs, it may cause damage or even destruction to LED devices. Damaged LEDs may show some unusual characteristics such as increase in leakage current, lowered turn-on voltage, or abnormal lighting of LEDs at low current.
- 10) VOCs (Volatile Organic Compounds) can be generated from adhesives, flux, hardener or organic additives used in luminaires (fixtures). Transparent LED silicone encapsulant is permeable to those chemicals and they may lead to a discoloration of encapsulant when they exposed to heat or light. This phenomenon can cause a significant loss of light emitted (output) from the luminaires. In order to prevent these problems, we recommend users to know the physical properties of materials used in luminaires and they must be carefully selected.
- 11) Risk of sulfurization (or tarnishing)

The LED from Samsung uses a silver-plated lead frame and its surface color may change to black (or dark colored) when it is exposed to sulfur (S), chlorine (Cl) or other halogen compound. Sulfurization of lead frame may cause intensity degradation, change of chromaticity coordinates and, in extreme cases, open circuit. It requires caution. Due to possible sulfurization of lead frame, LED should not be used and stored together with oxidizing substances made of materials such as rubber, plain paper, lead solder cream, etc.

Legal and additional information.

[About Samsung Electronics Co., Ltd.](#)

Samsung inspires the world and shapes the future with transformative ideas and technologies. The company is redefining the worlds of TVs, smartphones, wearable devices, tablets, digital appliances, network systems, and memory, system LSI, foundry and LED solutions. For the latest news, please visit the Samsung Newsroom at news.samsung.com.

Copyright © 2018 Samsung Electronics Co., Ltd. All rights reserved.
Samsung is a registered trademark of Samsung Electronics Co., Ltd.
Specifications and designs are subject to change without notice. Non-metric weights and measurements are approximate. All data were deemed correct at time of creation. Samsung is not liable for errors or omissions. All brand, product, service names and logos are trademarks and/or registered trademarks of their respective owners and are hereby recognized and acknowledged.

Samsung Electronics Co., Ltd.
95, Samsung 2-ro
Giheung-gu
Yongin-si, Gyeonggi-do, 446-711
KOREA

www.samsungled.com

SAMSUNG