

**SATA-A
SINGLE R/A
SMT**

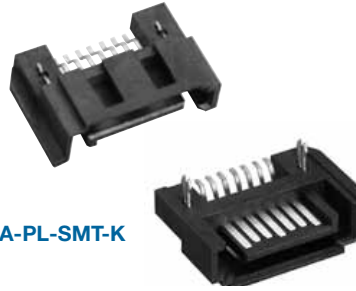

SATA-A-PL-SMT-K

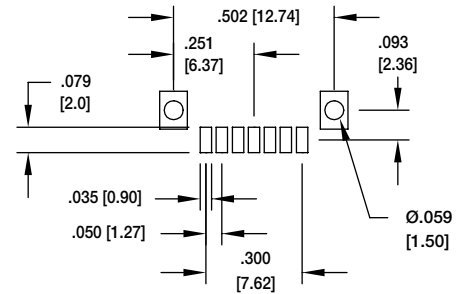
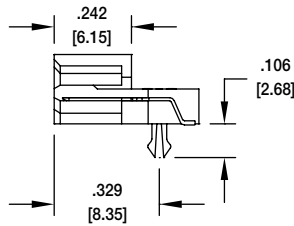
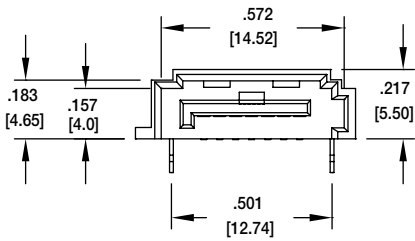
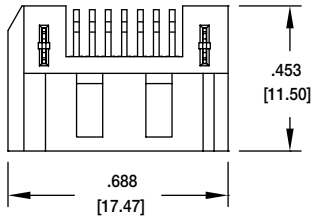

Recommended PCB Layout

**SATA-C
SINGLE R/A
SMT**



SATA-C-PR-SMT-K

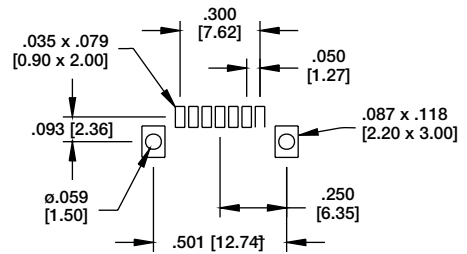
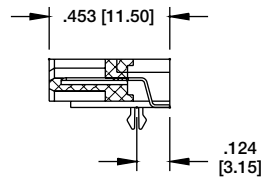
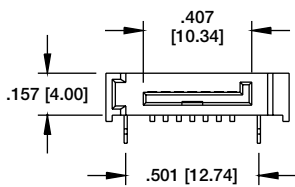
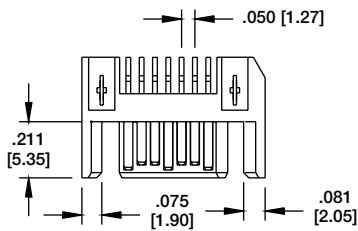

Recommended PCB Layout

SATA-B SHIELDED, R/A, TRUE SMT

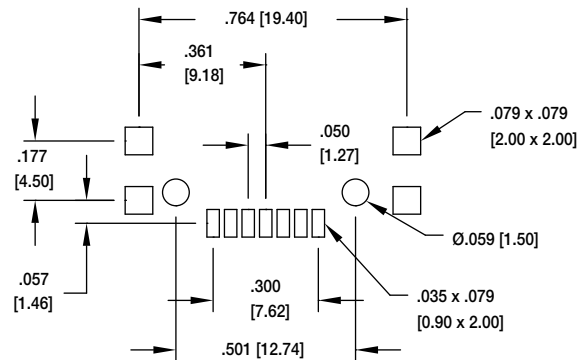
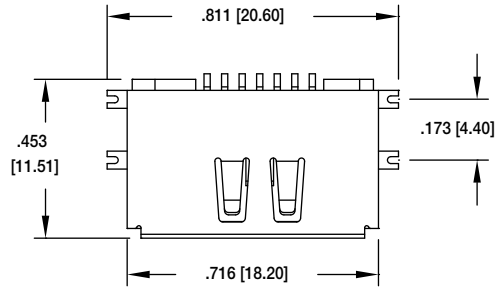

Recommended PCB Layout

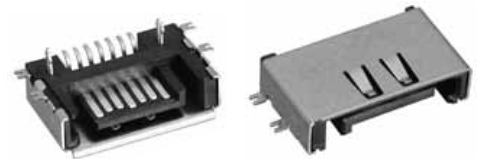
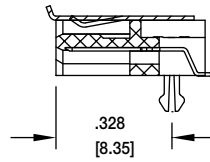
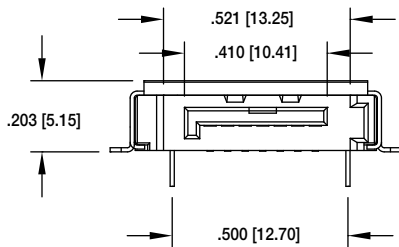

SATA-B-PL-SMT-K

SATA-J SHIELDED, R/A, SMT

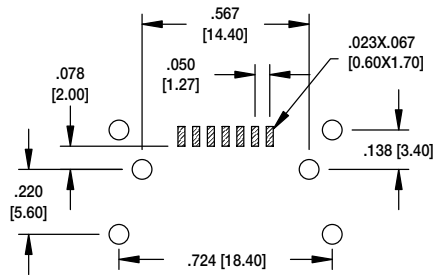
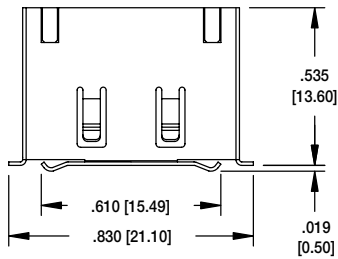

Recommended PCB Layout

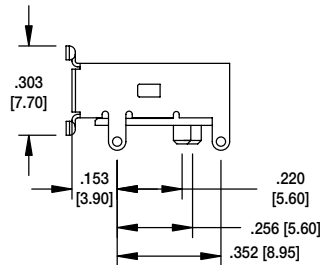
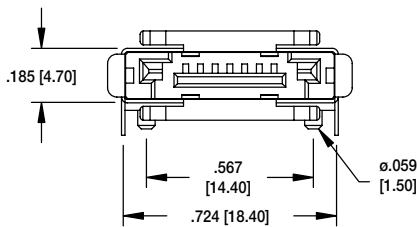

SATA-J-NP-SMT-P-S-PG

SATA-D
DUAL STACKED, SMT



SATA-D-PL-RT

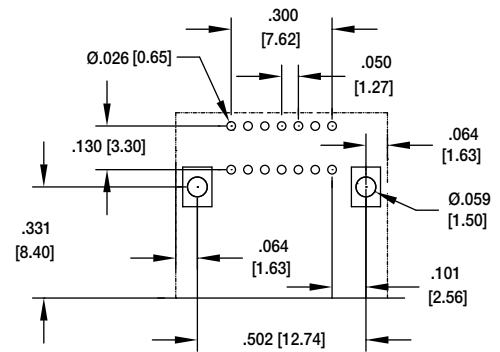
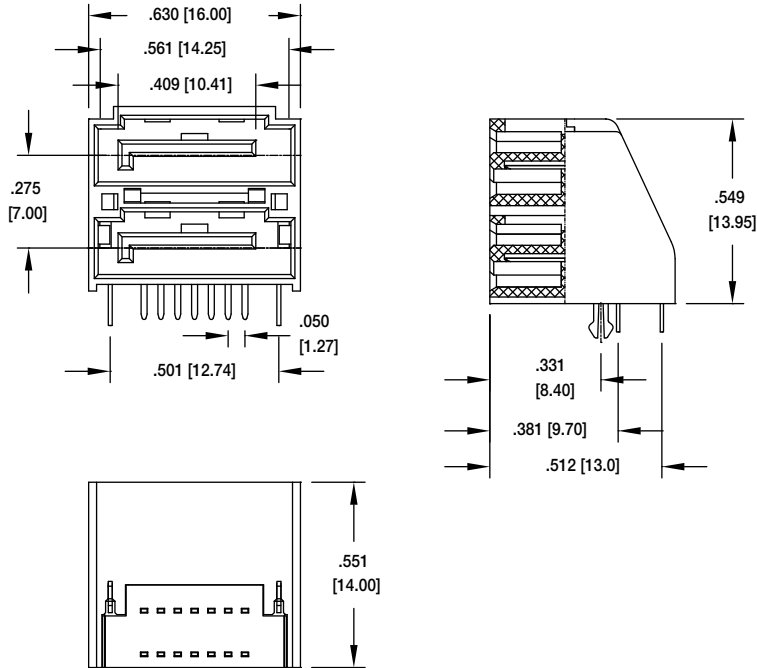

Recommended PCB Layout

SATA-E
DUAL, SIDE BY SIDE
THRU-HOLE



SATA-E-PR-SMT-K

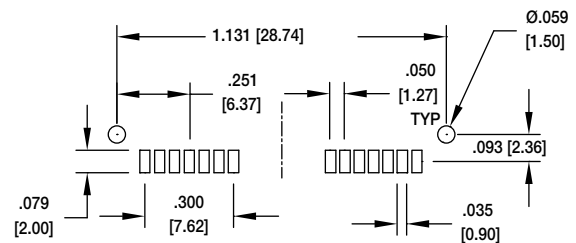
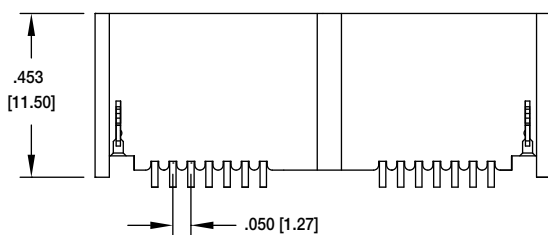
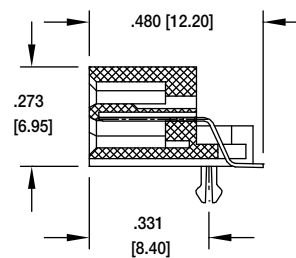
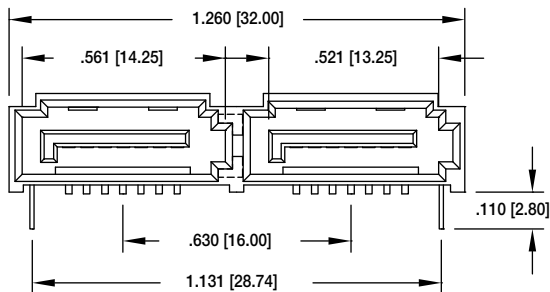

Recommended PCB Layout

SATA-F DUAL VERTICAL THRU-HOLE

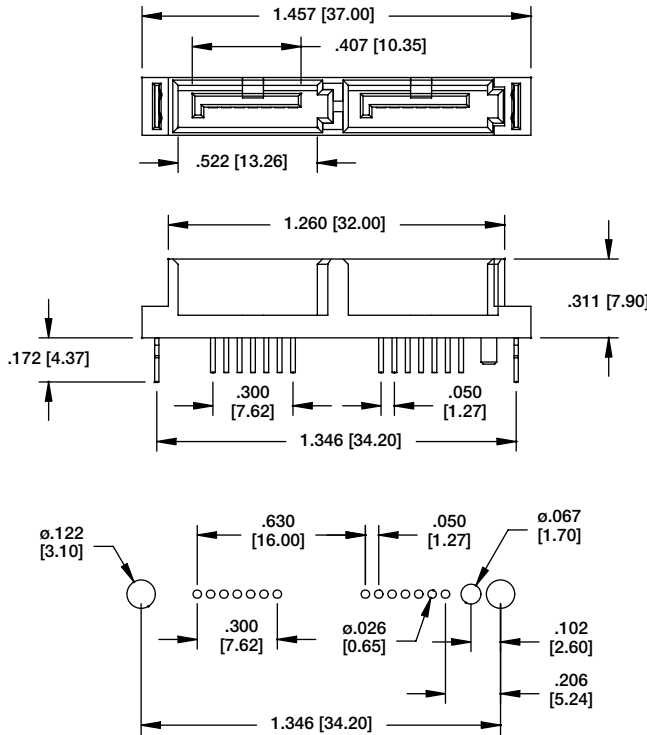

Recommended PCB Layout



SATA-F-PL-VT-K-P

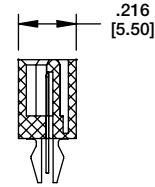

SATA-G DUAL VERTICAL SMT

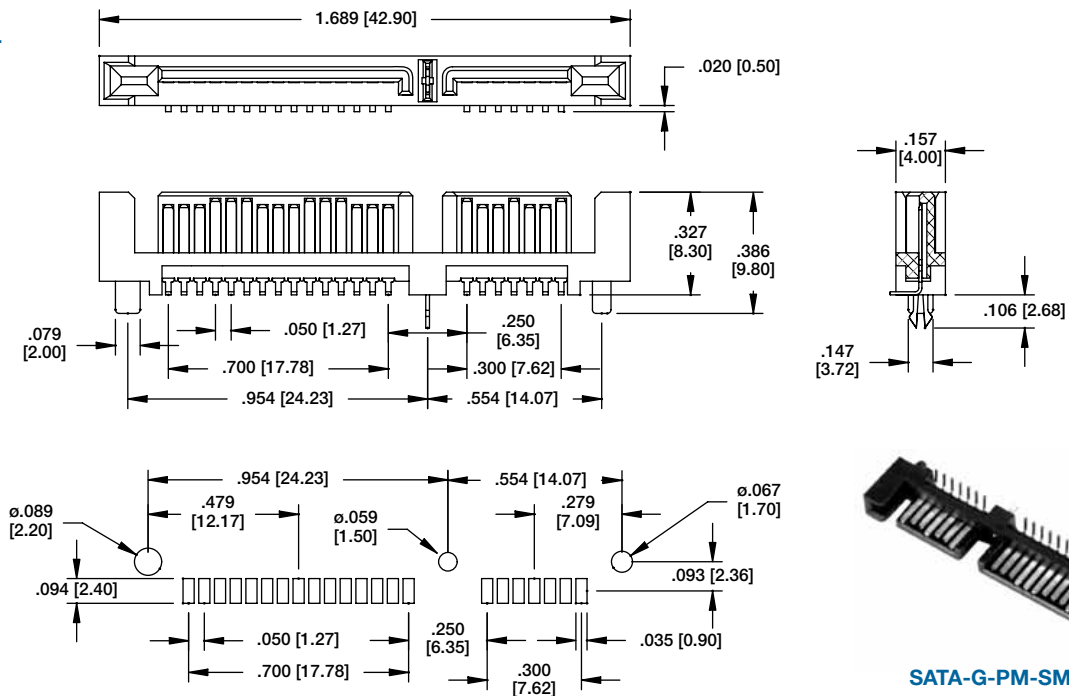

Recommended PCB Layout



SATA-G-PM-SMT

SATA-M
DUAL VERTICAL
THRU-HOLE

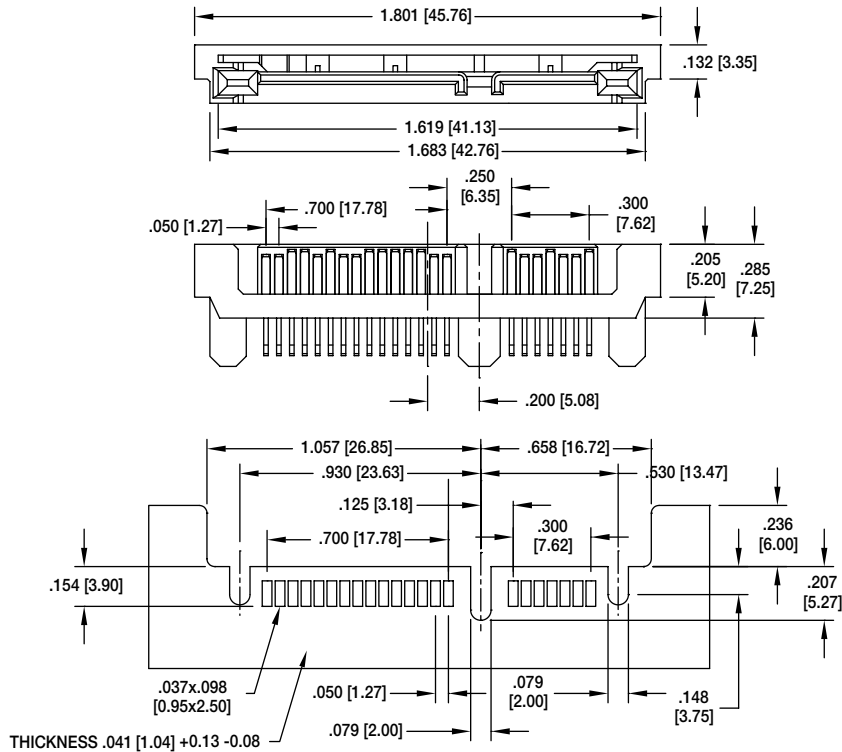

Recommended PCB Layout

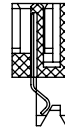

SATA-M-PM-SMT

SATA-G
DUAL
STRADDLE
MOUNT

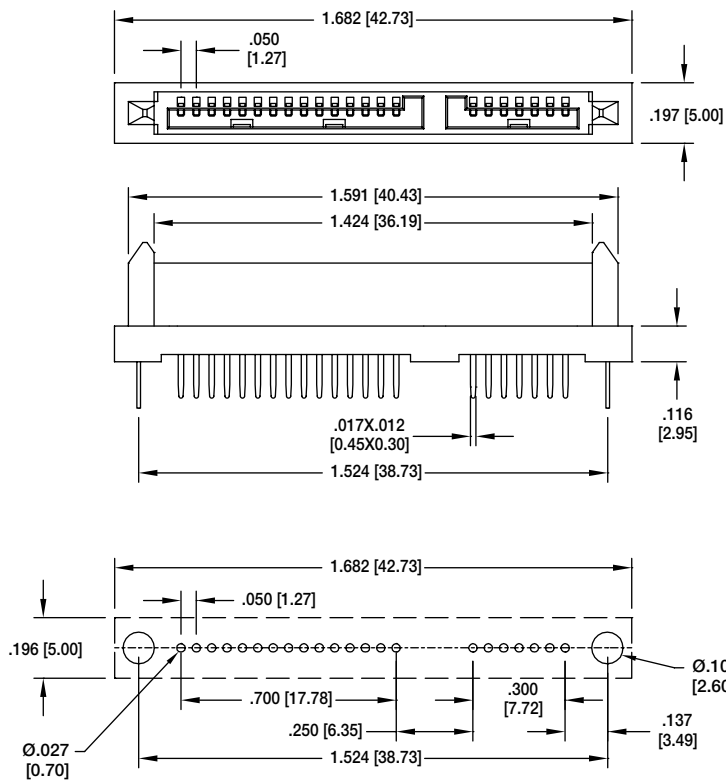

Recommended PCB Layout

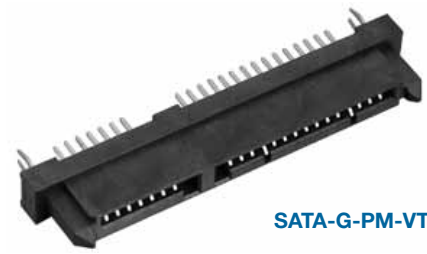
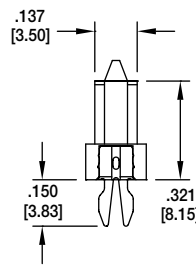

SATA-G-PM-VT