

Features

- ◆ RoHS Compliant
- ◆ Rectangular MELF SMQ Ceramic Package
- ◆ Low R_s for Low Series Loss
- ◆ Long τ_L for Low Intermodulation Distortion
- ◆ Low C_j for High Series Isolation
- ◆ High Average Incident Power Handling

Description and Applications

The MA4P7418-10720T is a surface mount PIN diode in a **Metal Electrode Leadless Faced (MELF)** package. The device incorporates M/A-COM Technology Solutions time proven HIPAX technology to produce a low inductance ceramic package with no ribbons or whisker wires. Incorporated in the package is a fully passivated PIN diode chip that is full face bonded on both the cathode and anode to maximize the surface contact area for low electrical and thermal resistance. The MA4P7418-10720T has been comprehensively characterized both electrically and mechanically to ensure repeatable and predictable performance. The diode is well suited for use in low loss, low distortion, high power switching circuits. The low thermal resistance of this device provides excellent high average performance at RF power incident levels up to 200 watts CW. This device is designed to meet the most rigorous electrical and mechanical requirements.



1072

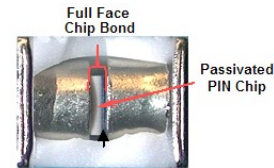

Diode Cross Section

Designed for Automated Assembly

SMQ MELF PIN diodes are designed for high volume tape and reel assembly. The rectangular package design provides a highly efficient means for automatic pick and place assembly techniques. The parallel flat surfaces are suitable for key jaw or vacuum pickup techniques. All solderable surfaces are tin plated and compatible with reflow and vapor phase soldering methods.

Absolute Maximum Ratings¹ @ +25°C

Parameter	Absolute Maximum
Operating Temperature	-65°C to +125°C
Storage Temperature	-65°C to +200°C
Diode Junction Temperature	+175°C
Diode Mounting Temperature	+265°C for 10 seconds
C.W. Thermal Resistance (Θ_{jc}) Using Infinite Heat Sink	13 °C/W
Power Dissipation @ +25°C De-rate linearly by to 0W @ +175C by -76.6 mW/°C Using Infinite Heat Sink	11.5 W
Forward D.C. Current	+150mA
Reverse D.C. Voltage	-1100V

1. Exceeding any of these limits may cause permanent damage.

Typical Electrical Performance @ +25°C

MA4P7418-1072T Rs vs I

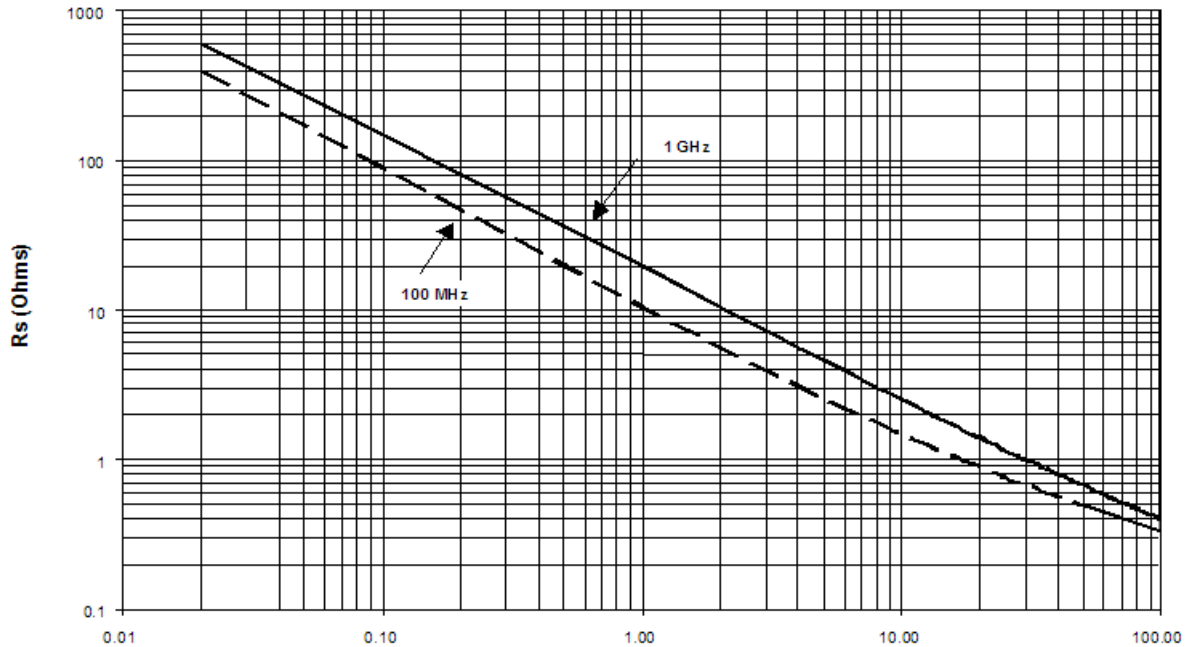

MA4P7418-1072T Rp vs Voltage

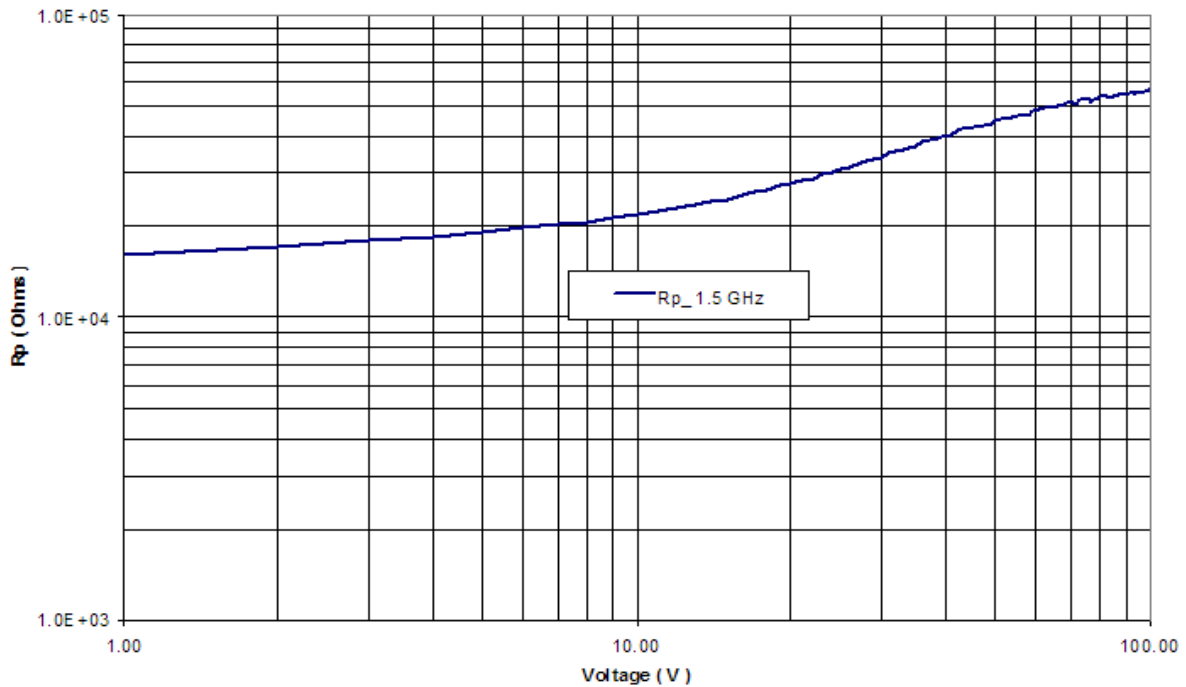

Typical Electrical Performance @ +25°C

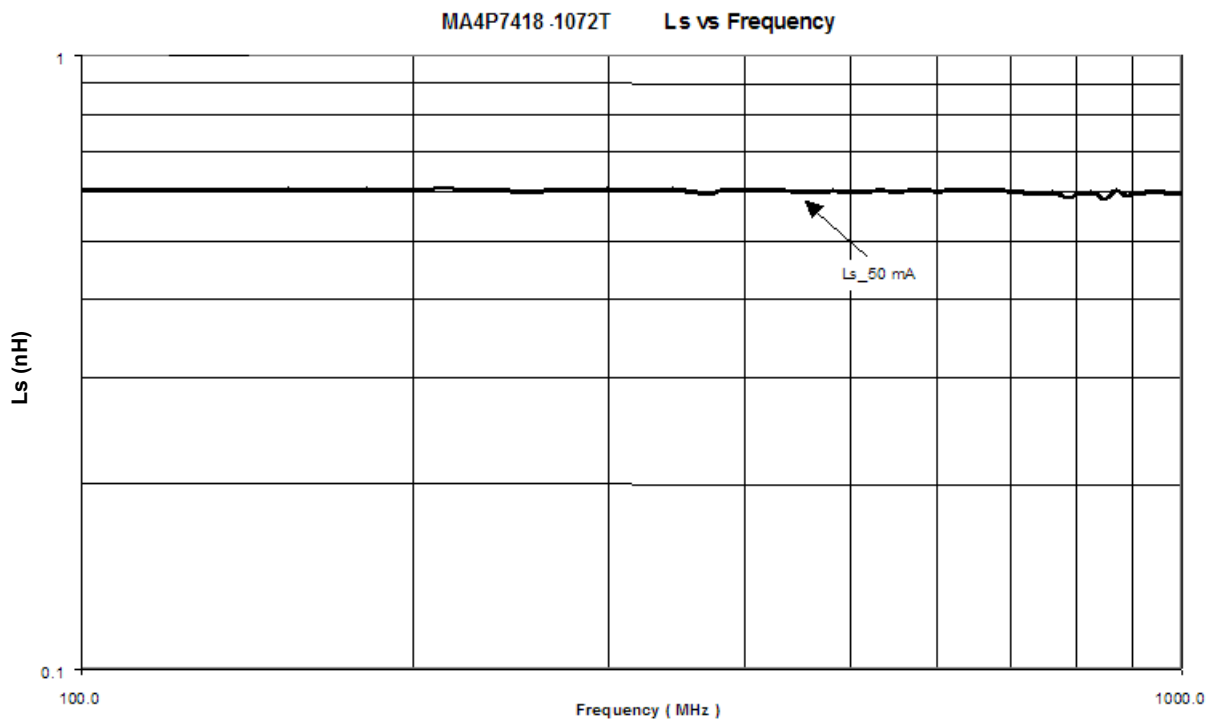
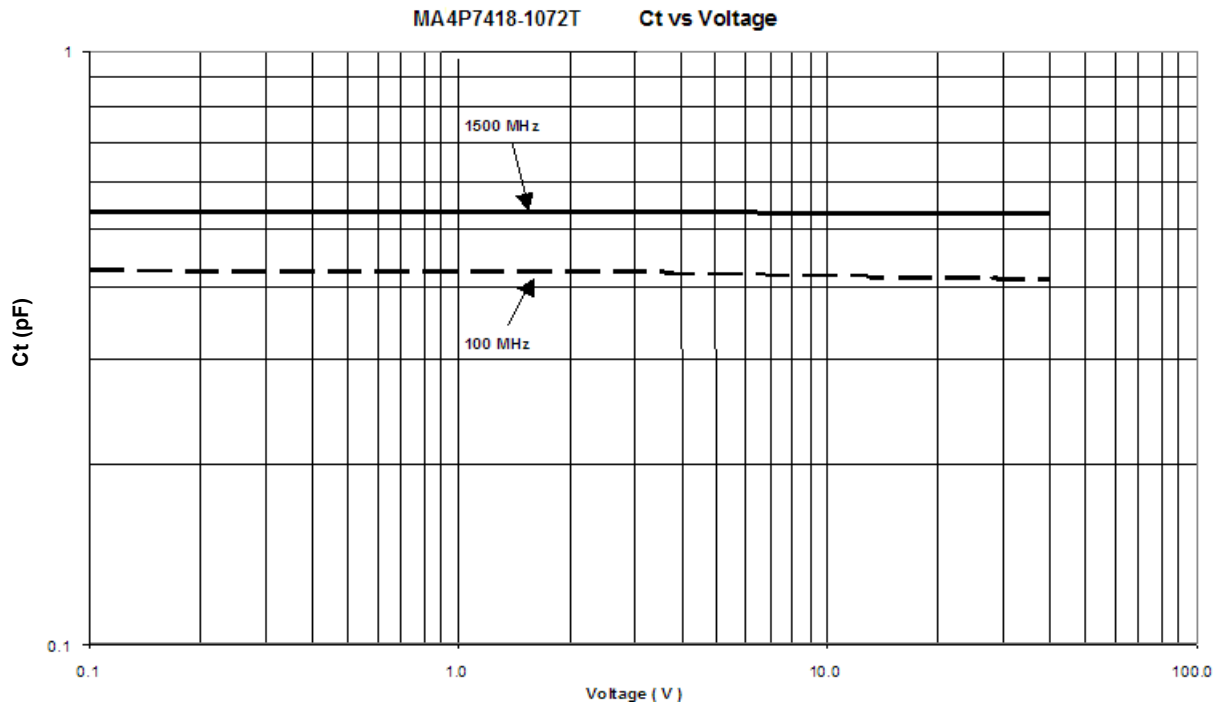

SMQ MELF PIN Diode

Rev. V4

Electrical Specifications @ +25 °C

Parameter	Symbol	Condition	Unit Value
Forward Voltage (Maximum)	V_F	$I_F = +100\text{mA}$	$1.0 V_{DC}$
Voltage Rating (Minimum) ¹	V_R	$I_r = -10\mu\text{A}$	$ -1100 V_{DC}$
Total Capacitance (Maximum)	C_T	$-100\text{V @ } 100\text{MHz}$	0.8pF
Series Resistance (Maximum)	R_S	$+100\text{mA @ } 100\text{MHz}$	1.2 Ohms
Parallel Resistance (Minimum)	R_P	$-10\text{V @ } 100\text{MHz}$	$50\text{K } \Omega$
Carrier Lifetime (Nominal)	τ_L	$+6\text{mA} / -10\text{mA} (50\% - 90\% \text{ Voltage})$	$7 \mu\text{s}$
Turn on Delay, T_{ON} (Maximum) ²	T_{ON}	$50\% \text{ Control Voltage} - 90\% \text{ Output Voltage}$	$2.5 \mu\text{s}$
I-Region Length (Nominal)	μm	-	$140 \mu\text{m}$
C.W. Thermal Resistance (Maximum)	θ_{jc}	$I_H = 1\text{A}, I_L = 10\text{mA}, T = 1\text{mS}$	13°C/W
Power Dissipation in Free Air (Maximum)	W	$I_F = +100\text{mA}$	4W
Power Dissipation with IHS (Maximum)	P_D	$I_F = +100\text{mA}$	11.5W

Note:

- V_R (Reverse Voltage) is sourced and the resultant reverse leakage current, I_r , is measured to be $<10\mu\text{A}$.
- See below for turn on delay measurement

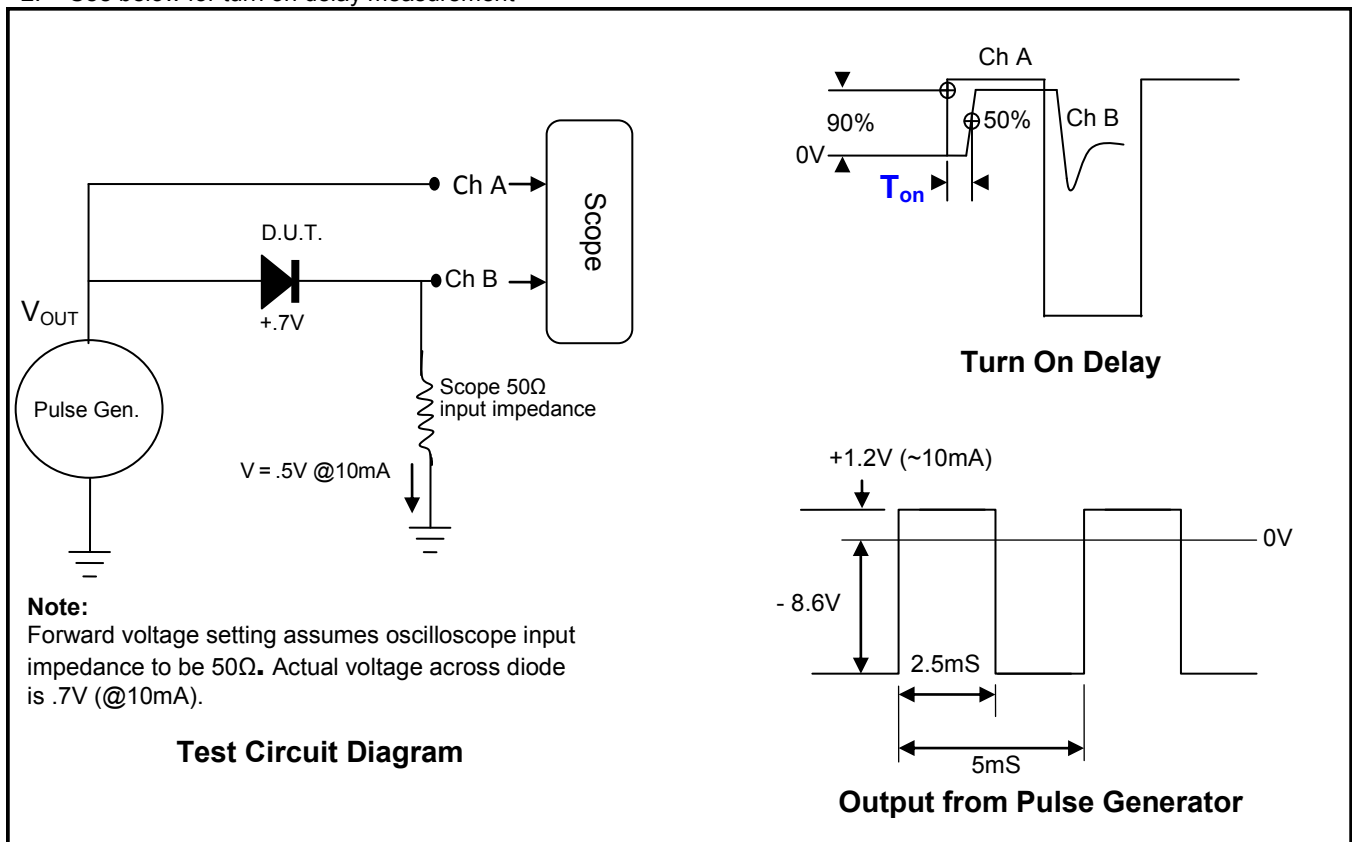

Environmental Capability

MELF devices may be used in industrial or military applications and can be screened to meet the environmental requirements of MIL-STD-750, MIL-STD-202 as well as other military standards. The table below lists some of the MIL-STD 750 tests the device is designed to meet.

MIL-STD-750		
Test	Method	Description
High Temperature Storage	1031	+150°C, for 340 Hours
Temperature Shock	1051	-65°C to +125°C, 20 Cycles
HTRB	1038	80% of rated V_B , +150 °C, for 96 Hours
Moisture Resistance	1021	No Initial Conditioning, 85% RH, +85°C
Gross Leak	1071 Cond. E	Dye Penetrant Visual
Vibration Fatigue	2046	20,000 G's, 60 Hz, x, y, z axis
Solderability	2026	Test Temperature = +245°C

1072 MELF Surface Mount Package

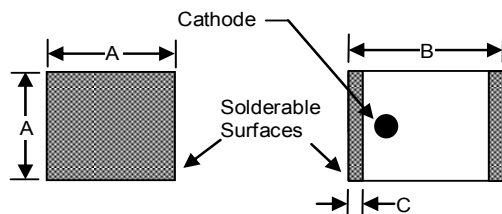

Dimension	INCHES		MM	
	MIN.	MAX.	MIN.	MAX.
A	0.080	0.095	2.032	2.413
B	0.115	0.135	2.921	3.429
C	0.008	0.030	0.203	0.762

Circuit Pad Layout for 1072 MELF

Dimension	inches	mm
A	0.093	2.36
B	0.050	1.27
C	0.060	1.52

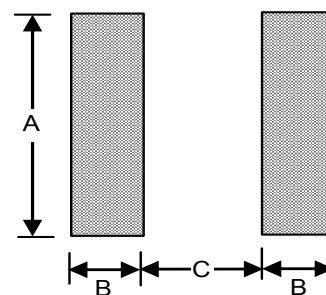

Ordering Information

Part Number	Package	Quantity
MA4P7418-1072T	Tape and reel	1500ps

M/A-COM Technology Solutions Inc. All rights reserved.

Information in this document is provided in connection with M/A-COM Technology Solutions Inc ("MACOM") products. These materials are provided by MACOM as a service to its customers and may be used for informational purposes only. Except as provided in MACOM's Terms and Conditions of Sale for such products or in any separate agreement related to this document, MACOM assumes no liability whatsoever. MACOM assumes no responsibility for errors or omissions in these materials. MACOM may make changes to specifications and product descriptions at any time, without notice. MACOM makes no commitment to update the information and shall have no responsibility whatsoever for conflicts or incompatibilities arising from future changes to its specifications and product descriptions. No license, express or implied, by estoppel or otherwise, to any intellectual property rights is granted by this document.

THESE MATERIALS ARE PROVIDED "AS IS" WITHOUT WARRANTY OF ANY KIND, EITHER EXPRESS OR IMPLIED, RELATING TO SALE AND/OR USE OF MACOM PRODUCTS INCLUDING LIABILITY OR WARRANTIES RELATING TO FITNESS FOR A PARTICULAR PURPOSE, CONSEQUENTIAL OR INCIDENTAL DAMAGES, MERCHANTABILITY, OR INFRINGEMENT OF ANY PATENT, COPYRIGHT OR OTHER INTELLECTUAL PROPERTY RIGHT. MACOM FURTHER DOES NOT WARRANT THE ACCURACY OR COMPLETENESS OF THE INFORMATION, TEXT, GRAPHICS OR OTHER ITEMS CONTAINED WITHIN THESE MATERIALS. MACOM SHALL NOT BE LIABLE FOR ANY SPECIAL, INDIRECT, INCIDENTAL, OR CONSEQUENTIAL DAMAGES, INCLUDING WITHOUT LIMITATION, LOST REVENUES OR LOST PROFITS, WHICH MAY RESULT FROM THE USE OF THESE MATERIALS.

MACOM products are not intended for use in medical, lifesaving or life sustaining applications. MACOM customers using or selling MACOM products for use in such applications do so at their own risk and agree to fully indemnify MACOM for any damages resulting from such improper use or sale.