

# HDR Series

# HDRA Series

# HDR系列

# HDRA系列

**0.8mm pitch interface connector**  
0.8mm



## Features

### ★Compact and robust

Mating pitch; 0.8mm  
0.8mm

### ★Abundant variation

Various choices for PC board side and cable side

### ★Industrial camera standard compatible

Support camera link  
Camera Link

### ★Support EMI/ESD

EMI/ESD  
Prevent noise with metal shell

### ★High Durability

Design for High Durability of 5,000 times  
5,000

### ★Support high speed transmission

LVDS signal, etc.  
LVDS

# HDR series and HDRA series Differences!

## HDR HDRA

While basic specifications such as mating pitch (0.8mm) are same, the both series have the following differences.

0.8mm

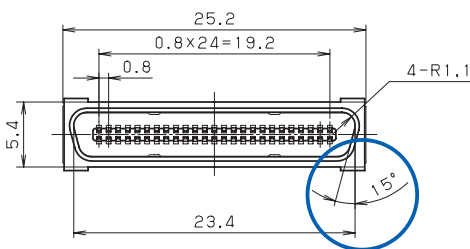
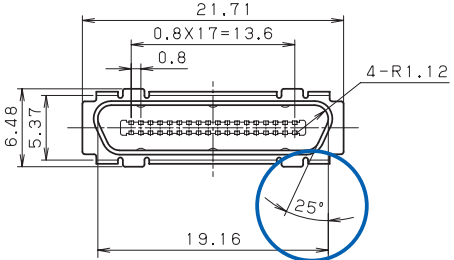
	HDR	HDRA
① Mating Position portion shape		
② Number of contacts	14, 26, 50	36, 68, 100
③ Compatible with standards	Camera link (AIA)	SCSI-III (ANSI/SFF8441)

## Specification

### HDRSeries HDR

Rated voltage	AC 125V(r.m.s.)
Rated current	0.5 A / Terminal 0.5A/端子
Insulated resistance	1,000 M-Ohm or more at DC 250 V 在DC 250V的条件下1000MΩ以上
Dielectric withstanding voltage	AC 350V(r.m.s.)
Contact resistance	70 m-Ohm or less 70mΩ以下
Storage temperature	-40 degree-C to 70 degree-C -55 degree-C to 85 degree-C (without case) -40℃至70℃ -55℃至85℃ (无外壳时)

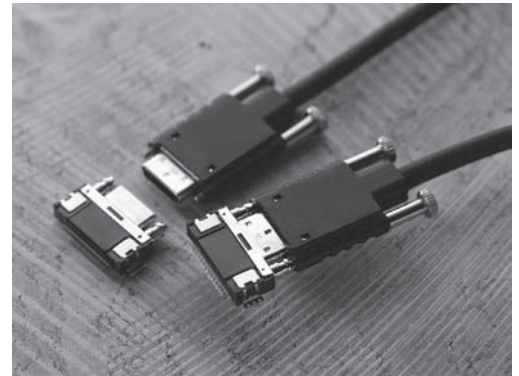

### HDRASeries HDRA

Rated voltage	AC 30V(r.m.s.)
Rated current	0.3 A / Terminal 0.3A/端子
Insulated resistance	500 M-Ohm or more at DC 100 V 在DC 100V的条件下500MΩ以上
Dielectric withstanding voltage	AC 250V(r.m.s.)
Contact resistance	70 m-Ohm or less 70mΩ以下
Storage temperature	-40 degree-C to 70 degree-C -55 degree-C to 85 degree-C (without case) -40℃至70℃ -55℃至85℃ (无外壳时)



# Applications

## Camera & image processing systems

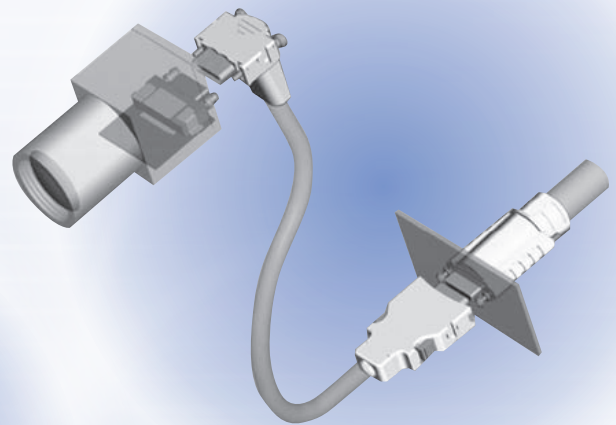

## RAID / Communication devices

RAID

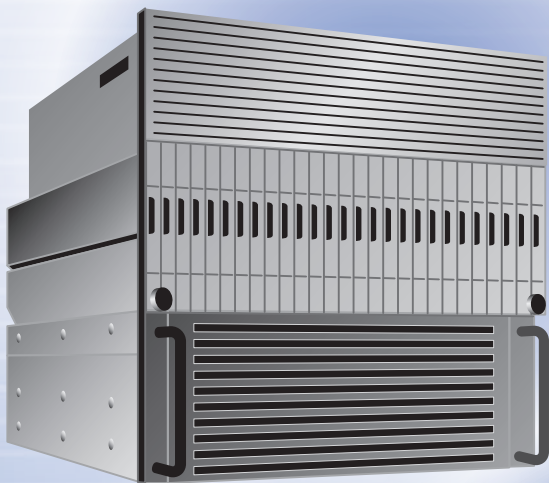

## Machine tools / Robots

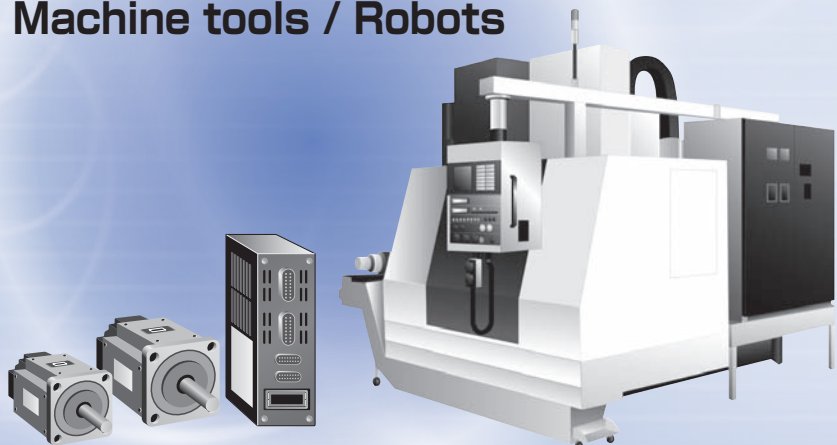

**Space saving**

**High design flexibility**

**High reliability**

**Measuring devices**



**Office equipments**

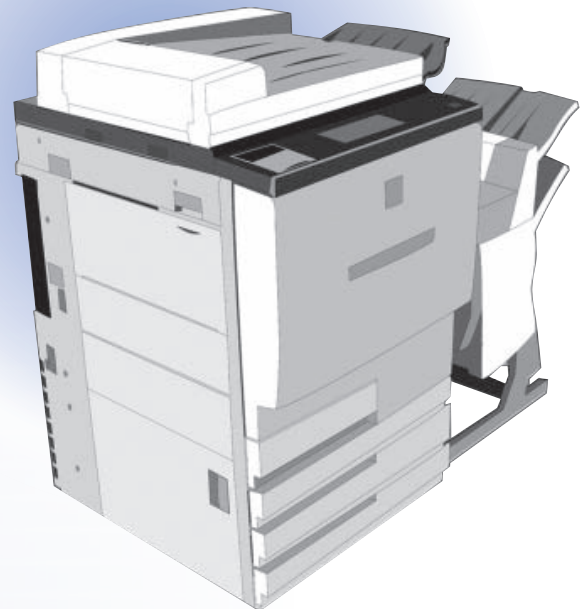

**Medical equipments**

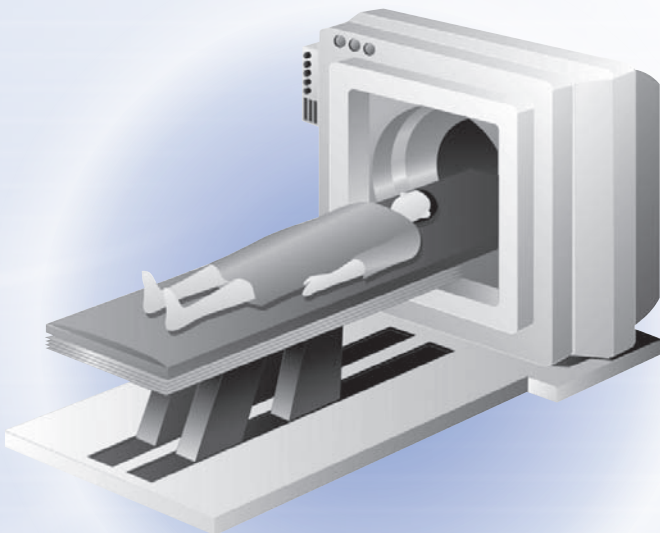

# Fulfill your plans!

## PC board to cable

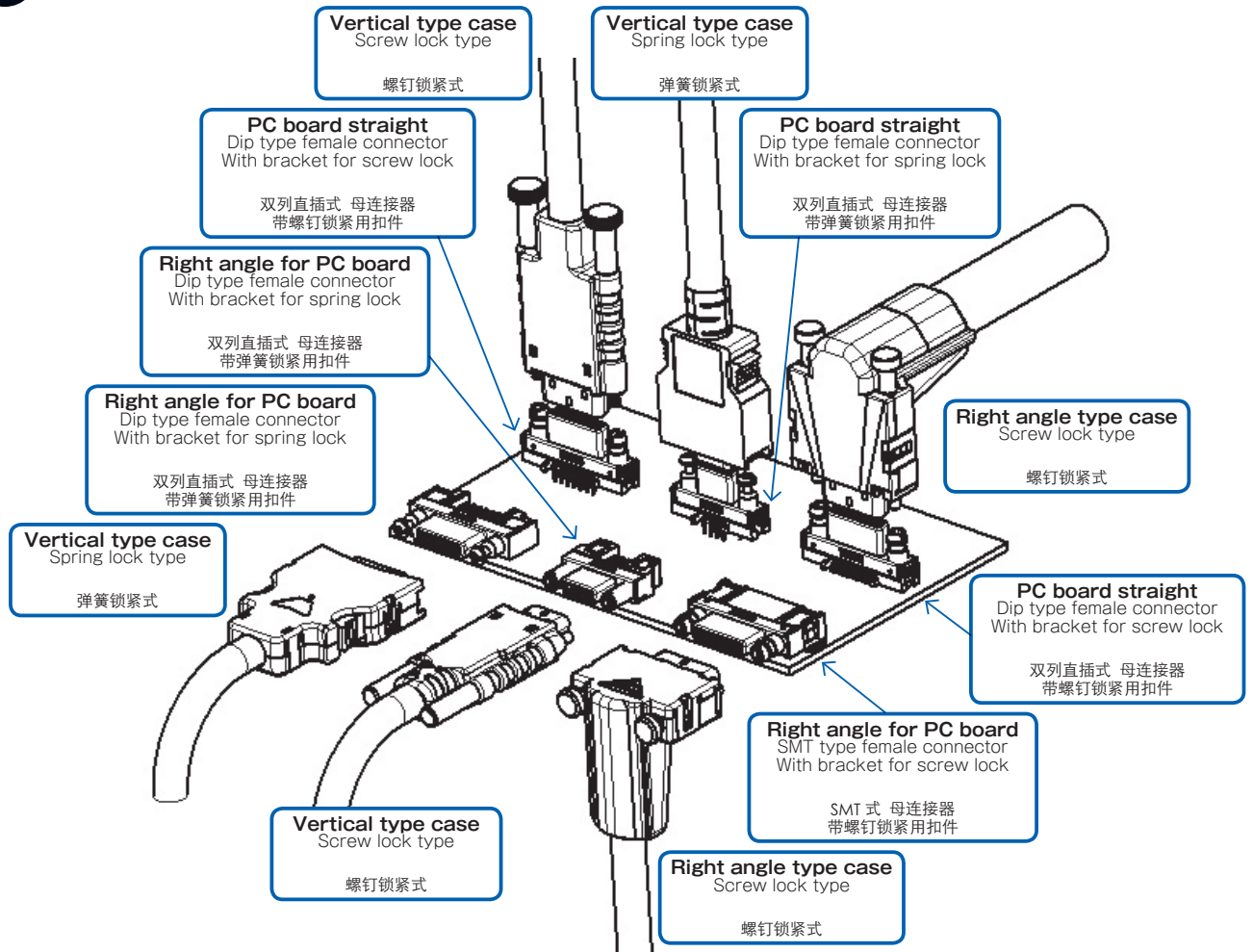

## Cable to cable

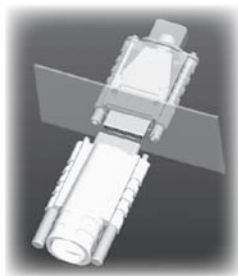

Screw lock type  
螺钉锁紧式



Spring lock type  
弹簧锁紧式

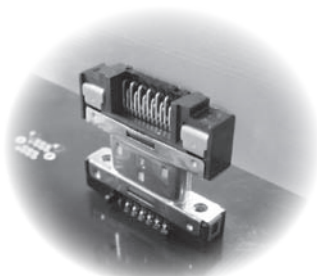

Vertical connection type  
垂平连接式

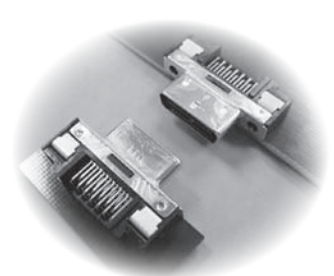

Horizontal connection type  
水平连接式

## For board to board



**1** Direction of connector on PC board side?  
基板侧连接器的方向如何?

⇒ **Right angle or straight**

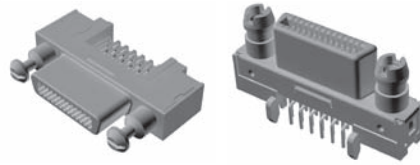

**2** Mounting method of PC board side?  
基板侧安装方法如何?

⇒ **Dip or SMT**

SMT

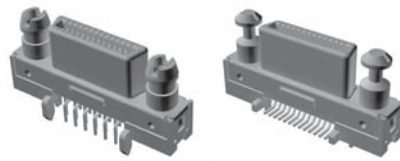

**3** Locking mechanism of PC board side?  
基板侧锁紧机构如何?

⇒ **Spring lock or screw lock**



**4** Number of contacts in PC board side?  
基板侧芯数多少?

⇒ **14,26,36,50,68,100**



**5** Direction of cable side case?  
电缆侧外壳的方向如何?

⇒ **Right angle or straight**

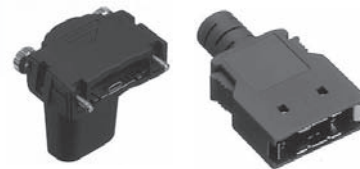

**6** Locking mechanism of cable side?  
电缆侧锁紧机构如何?

⇒ **Spring lock or screw lock**



**7** Wire connection method of cable side connector?  
电缆侧连接器的接线方法如何?



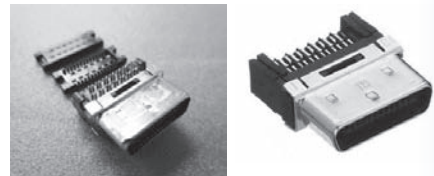

⇒ **Insulation displacement or soldering**





**8** Number of contacts in cable side?  
电缆侧芯数多少?

⇒ **14,26,36,50,68,100**



Type	Direction	Mounting method	Locking screw	Number of contacts	Part No.	
Female connector of PC board side 基板侧母连接器	Right angle 直角	Dip 双列直插 	None 无	14	HDR-EC14LFDTG2+	
				26	HDR-EC26LFDTG2+	
				50	HDR-EC50LFDTG2+	
				36	HDRA-EA36LFDT+	
				68	HDRA-EC68LFDT+	
				100	HDRA-EC100LFDT+	
		Spring lock 弹簧锁紧	14	HDR-EC14LFDTG2-SLE+		
			26	HDR-EC26LFDTG2-SLE+		
			50	HDR-EC50LFDTG2-SLE+		
			36	HDRA-EA36LFDT-SLE+		
			Screw lock 螺钉锁紧	14	HDR-EC14LFDTG2-SLD+	
				26	HDR-EC26LFDTG2-SLD+	
	50	HDR-EC50LFDTG2-SLD+				
	68	HDRA-EC68LFDT-SLD+				
	100	HDRA-EC100LFDT-SLD+				
	SMT 	None 无		14	HDR-EA14LFYPG1+	
			26	HDR-EA26LFYPG1+		
		Spring lock 弹簧锁紧	14	HDR-EA14LFYPG1-SLE+		
			26	HDR-EA26LFYPG1-SLE+		
		Screw lock 螺钉锁紧	14	HDR-EA14LFYPG1-SLD+		
			26	HDR-EA26LFYPG1-SLD+		
	68	HDRA-EA68LFZGT-SLD+				
		Straight 平直	Dip 双列直插 	None 无	14	HDR-EC14FDTG2+
					26	HDR-EC26FDTG2+
68					HDRA-EC68FDT+	
100					HDRA-EC100FDT+	
Spring lock 弹簧锁紧			14	HDR-EC14FDTG2-SLE+		
	26		HDR-EC26FDTG2-SLE+			
Screw lock 螺钉锁紧	14	HDR-EC14FDTG2-SLD+				
	26	HDR-EC26FDTG2-SLD+				
	68	HDRA-EC68FDT-SLD+				
	100	HDRA-EC100FDT-SLD+				
SMT 	None 无	14	HDR-EC14FYTG2+			
		26	HDR-EC26FYTG2+			
	Spring lock 弹簧锁紧	14	HDR-EC14FYTG2-SLE+			
		26	HDR-EC26FYTG2-SLE+			
	Screw lock 螺钉锁紧	14	HDR-EC14FYTG2-SLD+			
		26	HDR-EC26FYTG2-SLD+			
Male connector of PC board side 基板侧公连接器	Right angle 直角	SMT 	None 无	14	HDR-EA14LMYPG1+	
				26	HDR-EA26LMYPG1+	
				14	HDR-EA14LMYPG1-SLE+	
				26	HDR-EA26LMYPG1-SLE+	
		Spring lock 弹簧锁紧	14	HDR-EA14LMYPG1-SLD+		
			26	HDR-EA26LMYPG1-SLD+		
			Dip 双列直插 	None 无	26	HDR-EC26LMDTG1+
						Spring lock 弹簧锁紧
	Screw lock 螺钉锁紧	HDR-EC26LMDTG1-SLD+				

Name	Locking method	Applicable series	Panel thickness (mm) mm	Part No.
Lock screw 锁紧螺钉	Spring lock 弹簧锁紧 	HDR series only HDR系列专用	0	HDR-E14LMY-SL-02H
			0.8	HDR-E14LMY-SL-02E
			1.0	HDR-E14LMY-SL-02B
			1.2	HDR-E14LMY-SL-02FA
	Screw lock 螺钉锁紧 	HDR/HDRA series common HDR/HDRA系列兼用	0	HDRA-E68LFD-7C
			0.8	HDRA-E68LFD-7F
			1.0	HDRA-E68LFD-7E
		1.2	HDRA-E68LFD-7	





Name	Locking method	Cable outlet direction	Number of contacts	Part No.	Remarks	
Case for cable 电缆用外壳	For spring lock 弹簧锁紧用	Straight 平直	14	HDR-E14LPA5	For use with connectors:IDC type connectors only 适合连接器: 仅限压接式	
			26	HDR-E26LPA5	For use with connectors:IDC type connectors only 适合连接器: 仅限压接式	
			26	HDR-E26LPJ+	For use with connectors:IDC type and soldering type 适合连接器: 压接式和锡焊式	
			50	HDR-E50LPA5	For use with connectors:IDC type connectors only 适合连接器: 仅限压接式	
			36	HDRA-E36LPTH	For use with connectors:IDC type connectors only 适合连接器: 仅限压接式	
	For screw lock 螺钉锁紧用	Straight 平直	14	HDR-E14LPH	For use with connectors:IDC type and soldering type 适合连接器: 压接式和锡焊式	
			26	HDR-E26LPM+	For use with connectors:IDC type and soldering type 适合连接器: 压接式和锡焊式	
			26	HDR-E26LPH	For use with connectors:IDC type and soldering type 适合连接器: 压接式和锡焊式	
			26	HDR-E26LPK+	For thick wire; For use with connectors:IDC type and soldering type 粗线用 适合连接器: 压接式和锡焊式	
			50	HDR-E50LPH	For use with connectors:IDC type and soldering type 适合连接器: 压接式和锡焊式	
			68	HDRA-E68LGKPA	For use with connectors:IDC type connectors only 适合连接器: 仅限压接式	
		100	HDRA-E100LPA	For use with connectors:IDC type connectors only 适合连接器: 仅限压接式		
			Right angle 直角	26	HDR-E26ALPA+	For use with connectors:IDC type and soldering type 适合连接器: 压接式和锡焊式
	For joint 中转用	Straight 平直		14	HDR-E14LPHB+	For screw lock; Panel thickness: 0.8 mm 螺钉锁紧用 面板厚度: 0.8mm
				14	HDR-E14LPHC+	For screw lock; Without Panel 螺钉锁紧用 无面板
				14	HDR-E14LPHD+	For spring lock; Without Panel 弹簧锁紧用 无面板
				26	HDR-E26LPHB+	For screw lock; Panel thickness: 0.8 mm 螺钉锁紧用 面板厚度: 0.8mm
				26	HDR-E26LPHC+	For screw lock; Without Panel 螺钉锁紧用 无面板
				26	HDR-E26LPHD+	For spring lock; Without Panel 弹簧锁紧用 无面板
				26	HDR-E26LPKB+	For thick wire; For screw lock; Panel thickness: 0.8 mm 粗线用 螺钉锁紧用 面板厚度: 0.8mm
				26	HDR-E26LPKC+	For thick wire; For screw lock; Without Panel 粗线用 螺钉锁紧用 无面板
				26	HDR-E26LPKD+	For thick wire; For spring lock; Without Panel 粗线用 弹簧锁紧用 无面板



Name	Wire connection method	Shape	Number of contacts	Part No.	Remarks
Connector for cable 电缆用连接器	Insulation displacement type 压接式	Male 公	14	HDR-E14MAG1+	Compatible cable: AWG#30 (7/0.1) External jacket diameter: 0.58 mm or less 适合电缆: AWG#30(7/0.1)外覆直径: 0.58mm以下
			26	HDR-E26MAG1+	
			50	HDR-E50MAG1+	
			36	HDRA-E36MA+	
			68	HDRA-E68MA+	
			100	HDRA-E100MA1+	
	Soldering type 锡焊式	Male 公	14	HDR-E14MSG1+	Compatible cable: AWG#28 (7/0.127) External jacket diameter: 1.0 mm or less 适合电缆: AWG#28(7/0.127)外覆直径: 1.0mm以下
			26	HDR-E26MSG1+	
			50	HDR-E50MSG1+	
	Insulation displacement type 压接式	Female 母	14	HDR-E14FAG1+	Compatible cable: AWG#30 (7/0.1) External jacket diameter: 0.58 mm or less 适合电缆: AWG#30(7/0.1)外覆直径: 0.58mm以下
			26	HDR-E26FAG1+	
		Soldering type 锡焊式	Female 母	14	HDR-E14FSG1+
26				HDR-E26FSG1+	

Name	Wire connection method	Lock screw	Number of contacts	Part No.	Remarks
Connector for panel mount 面板座用连接器	Insulation displacement type 压接式	None 无	14	HDR-EC14PFAG1+	Compatible cable: AWG#30 (7/0.1) External jacket diameter: 0.58 mm or less 适合电缆: AWG#30(7/0.1)外覆直径: 0.58mm以下
			26	HDR-EC26PFAG1+	



# Combination of parts numbers in application example

Application example			Connector of PC board side	Case	Connector for cable
Item 项目	Condition 条件		P/N : HDR-EC26LFDTG2-SLE+	P/N : HDR-E26LPA5	P/N : HDR-E26MAG1+
Direction of PC board 基板方向	Right angle 直角				
Mounting 安装	DIP				
Locking method 锁紧方法	Spring 弹簧				
Number of contacts 芯数	26				
Direction of case 外壳朝向	Straight 平直				
Cable connection 电缆接线	Insulation displacement 压接				
Panel 有无面板	None 无				
Item 项目	Condition 条件		P/N : HDR-EC26FDTG2-SLD+	P/N : HDR-E26LPH	P/N : HDR-E26MAG1+
Direction of PC board 基板方向		Straight 平直			
Mounting 安装	DIP				
Locking method 锁紧方法		Screw 螺钉			
Number of contacts 芯数	26				
Direction of case 外壳朝向	Straight 平直				
Cable connection 电缆接线	Insulation displacement 压接	Soldering 锡焊			
Panel 有无面板	None 无				
Item 项目	Condition 条件		P/N : HDR-EC26FDTG2+	P/N : HDR-E26ALPA+	P/N : HDR-E26MAG1+
Direction of PC board 基板方向		Straight 平直			
Mounting 安装	DIP				
Locking method 锁紧方法		Screw 螺钉			
Number of contacts 芯数	26				
Direction of case 外壳朝向		Right angle 直角			
Cable connection 电缆接线	Insulation displacement 压接	Soldering 锡焊			
Panel 有无面板		Yes 有 t=0.8mm			
Item 项目	Condition 条件		P/N : HDRA-EC68LFDT+	P/N : HDRA-E68LGKPA	P/N : HDRA-E68MA+
Direction of PC board 基板方向	Right angle 直角				
Mounting 安装	DIP				
Locking method 锁紧方法		Screw 螺钉			
Number of contacts 芯数		68			
Direction of case 外壳朝向	Straight 平直				
Cable connection 电缆接线	Insulation displacement 压接				
Panel 有无面板		Yes 有 t=1.0mm			
Item 项目	Condition 条件		P/N : HDR-EA26LFYPG1+	P/N : HDR-E26LPA5	P/N : HDR-E26MAG1+
Direction of PC board 基板方向	Right angle 直角				
Mounting 安装		SMT			
Locking method 锁紧方法	Spring 弹簧				
Number of contacts 芯数	26				
Direction of case 外壳朝向	Straight 平直				
Cable connection 电缆接线	Insulation displacement 压接				
Panel 有无面板		Yes 有 t=0.8mm			

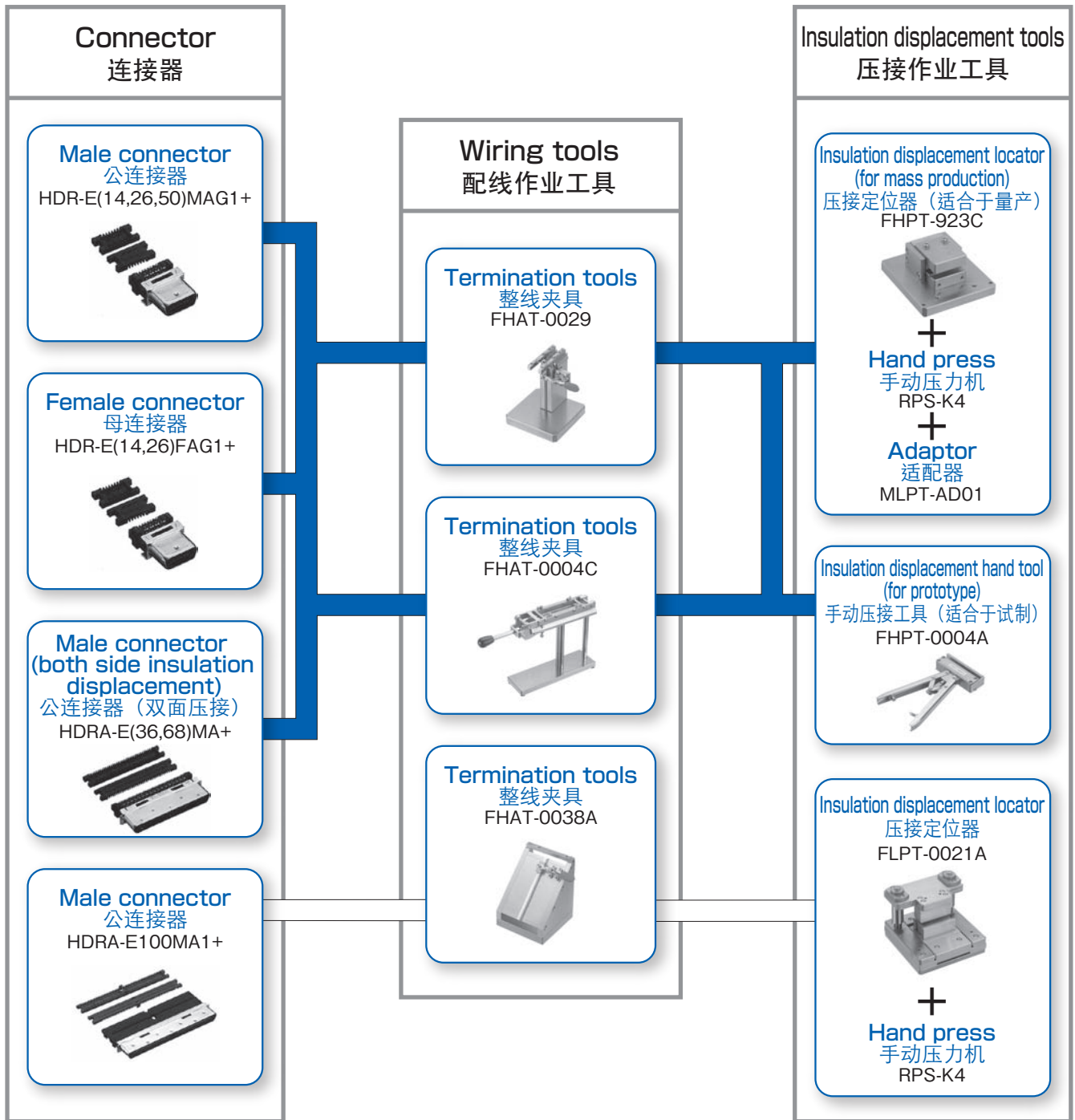

Clamp caulking tool		
Number of contacts	Applicable products	Jig parts numbers
14 contacts 14芯	HDR-E14LPA5	FHPT-0024A
	HDR-E14LPH	MHAT-0048A
	HDR-E14LPHB+	
	HDR-E14LPHC+	
	HDR-E14LPHD+	
36 contacts 36芯	HDRA-E36LPTH	FLPT-0024A
50 contacts 50芯	HDR-E50LPA5	FHPT-0023A
	HDR-E50LPH	MHPT-0010A

Clamp caulking tool		
Number of contacts	Applicable products	Jig parts numbers
26 contacts 26芯	HDR-E26LPA5	FHPT-0022A
	HDR-E26LPJ	
	HDR-E26LPH	MHPT-0006A
	HDR-E26LPHB+	
	HDR-E26LPHC+	
	HDR-E26LPHD+	
	HDR-E26LPK+	MLPT-0037B
	HDR-E26LPKB+	
	HDR-E26LPKC+	
	HDR-E26LPKD+	MHPT-0007A
HDR-E26LPM+		
HDR-E26ALPA+	MHPT-0012A	

# Cable assembly product

14 contacts

14

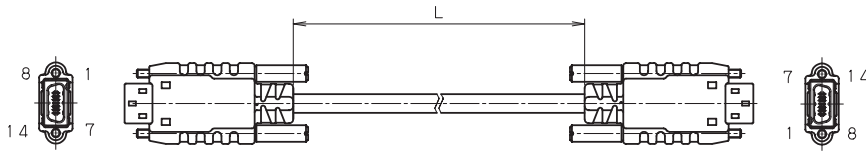

Cable length (m) m	Tolerance (mm) mm	Part No.	Remarks
1	±50	HDR-AS-0151-L100+	Connector:HDR-E14MAG1+ Case:HDR-E14LPH
3	±75	HDR-AS-0151-L300+	Cable:UL20276 7PX30AWG(7/0.102)black 连接器 : HDR-E14MAG1+
5	±125	HDR-AS-0151-L500+	壳体 : HDR-E14LPH 电缆 : UL20276 7PX30AWG (7/0.102) 黑色

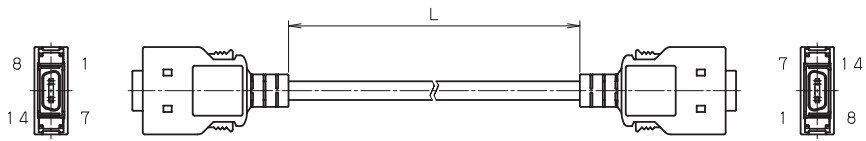

Cable length (m) m	Tolerance (mm) mm	Part No.	Remarks
1	±50	HDR-AS-0152-L100+	Connector:HDR-E14MAG1+ Case:HDR-E14LPA5
3	±75	HDR-AS-0152-L300+	Cable:UL20276 7PX30AWG(7/0.102)black 连接器 : HDR-E14MAG1+
5	±125	HDR-AS-0152-L500+	壳体 : HDR-E14LPA5 电缆 : UL20276 7PX30AWG (7/0.102) 黑色

50 contacts

50

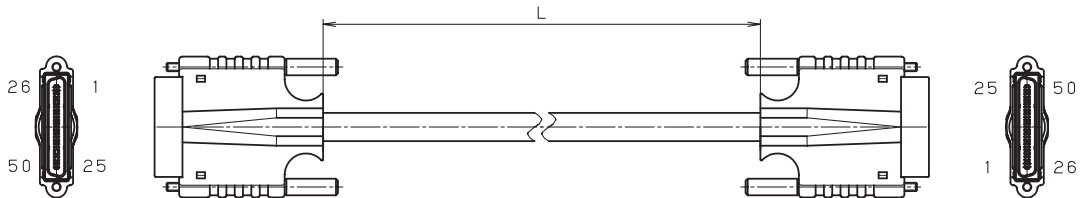

Cable length (m) m	Tolerance (mm) mm	Part No.	Remarks
1	±50	HDR-AS-0146-L100+	Connector:HDR-E50MAG1+ Case:HDR-E50LPH
3	±75	HDR-AS-0146-L300+	Cable:UL20276 25PX30AWG(7/0.102)black 连接器 : HDR-E50MAG1+
5	±125	HDR-AS-0146-L500+	壳体 : HDR-E50LPH 电缆 : UL20276 25PX30AWG (7/0.102) 黑色

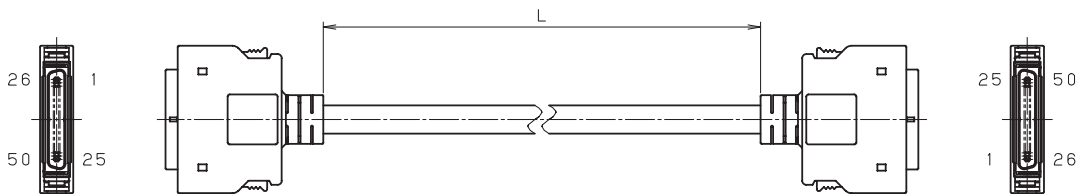

Cable length (m) m	Tolerance (mm) mm	Part No.	Remarks
1	±50	HDR-AS-0147-L100+	Connector:HDR-E50MAG1+ Case:HDR-E50LPA5
3	±75	HDR-AS-0147-L300+	Cable:UL20276 25PX30AWG(7/0.102)black 连接器 : HDR-E50MAG1+
5	±125	HDR-AS-0147-L500+	壳体 : HDR-E50LPA5 电缆 : UL20276 25PX30AWG (7/0.102) 黑色

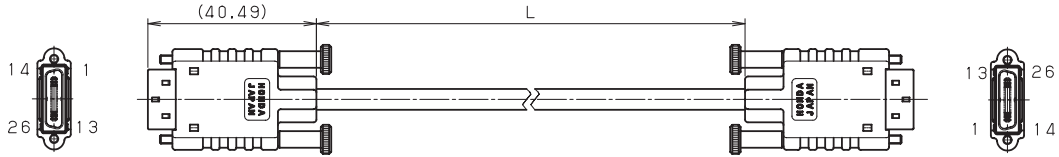

Cable length (m) m	Tolerance (mm) mm	Part No.	Remarks
1	±50	HDR-AS-0148-L100+	Connector:HDR-E26MAG1+ Case:HDR-E26LPH
3	±75	HDR-AS-0148-L300+	Cable:UL20276 13PX30AWG(7/0.102)black 连接器：HDR-E26MAG1+
5	±125	HDR-AS-0148-L500+	壳体：HDR-E26LPH 电缆：UL20276 13PX30AWG (7/0.102) 黑色

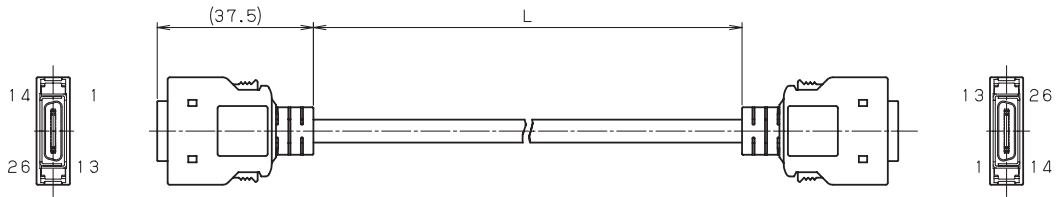

Cable length (m) m	Tolerance (mm) mm	Part No.	Remarks
1	±50	HDR-AS-0149-L100+	Connector:HDR-E26MAG1+ Case:HDR-E26LPA5
3	±75	HDR-AS-0149-L300+	Cable:UL20276 13PX30AWG(7/0.102)black 连接器：HDR-E26MAG1+
5	±125	HDR-AS-0149-L500+	壳体：HDR-E26LPA5 电缆：UL20276 13PX30AWG (7/0.102) 黑色

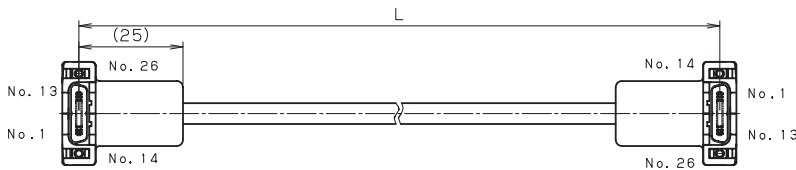

Cable length (m) m	Tolerance (mm) mm	Part No.	Remarks
1	±50	HDR-AS-0150-L100+	Connector:HDR-E26MAG1+ Case:HDR-E26ALPA+
3	±75	HDR-AS-0150-L300+	Cable:UL20276 13PX30AWG(7/0.102)black 连接器：HDR-E26MAG1+
5	±125	HDR-AS-0150-L500+	壳体：HDR-E26ALPA+ 电缆：UL20276 13PX30AWG (7/0.102) 黑色

### <Wiring chart>

#### 14 contacts 14

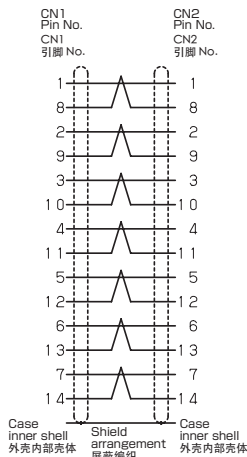

#### 26 contacts 26

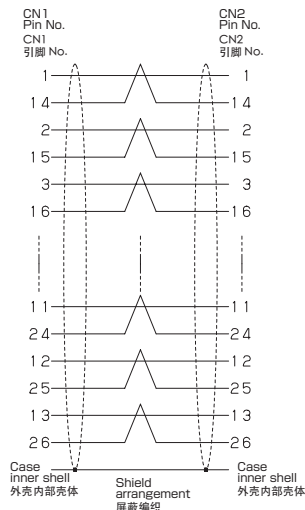

#### 50 contacts 50

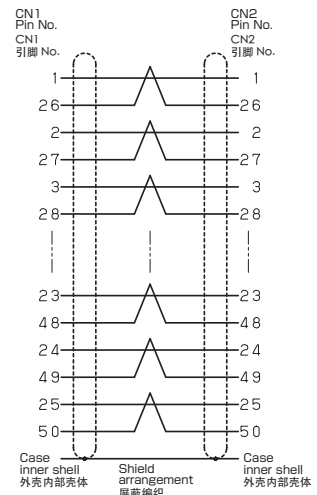

# Connect To The Next



## Caution

- Minimum lot volume is set for each product for sales lot.
- Please be advised that contents of this catalog are subject to change without advanced notice for improvement, etc.
- Please contact distributors or our sales representative for details of products listed in this catalog.
- 各产品分别设有最小销售批次；
- 本产品目录所记载的内容可能因改良等而变更，恕不另行通知；
- 有关本产品目录所记载的产品详情，请咨询经销商或本公司。



- For details for products such as stocks, delivery and prices, please contact:
- 库存、交货期、价格等与产品相关的咨询

**本多通信工業株式会社**

<http://www.honda-connectors.co.jp/>

Contents of this catalog are based on the information as of October, 2012.  
本产品目录所记载的内容为2012年10月时点的情况。