

FTP Series

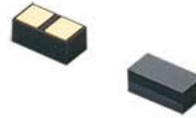

PTC Thermistor “Micro Heater”

(Flat Thin head Insulated Type)

FTP Series

Features

- Self-Temperature Control by PTC characteristics.
- Low voltage operation
- Top surface insulated SMD part
- Compact light design
- Fastest time heating operation
- Small spot heating
- Design free heating layout

Applications

- Heating Electric Device for Temperature compensation
- Removal of dew condensation or freeze
(Camera, Mirror etc.)
- Beauty and Health-Care application
(Massager etc.)
- Paper dryer for PPC printer
- Several Accessory warmer

Overview

The FTP series generate heat at specified temperature when voltage is applied and also serve to control temperature.

The FTP series are mounted PTC ceramics, so high reliability and quick heating up are available.

Also outer size is small, so the FTP series can heat required small part only. And electricity loss can be minimized as for heating.

In addition to the above, the FTP series can be operated with low voltage battery.

These help the customer downsize heating construction and high performance.

Attention:

This datasheet is downloaded from the website of Murata Manufacturing Co., Ltd.
Therefore, it's specifications are subject to change or our products in it may be discontinued without advance notice.
Please check with our sales representatives or product engineers before ordering.

TABLE OF CONTENT

1. Introduction	1
2. Selection Guide	3
2.1 Part Numbering	
3. Specifications	4
3.1 Line up	
3.2 Resistance-Temperature Characteristics Typical Curve	
3.3 Reliability Tests	
4. Fundamental Data	7
4.1 Experimental Setup	
4.2 Experiment Data (Temperature rise vs. Time)	
4.3 Experiment Data (Summary)	
5. Dimension, Land Pattern	11
6. Packing	12
6.1 Taping Specification	
6.2 Reeling	
7. ⚠CAUTION	14

Attention:

This datasheet is downloaded from the website of Murata Manufacturing Co., Ltd. Therefore, it's specifications are subject to change or our products in it may be discontinued without advance notice. Please check with our sales representatives or product engineers before ordering.

2. Selection Guide

2.1 Part Numbering

PTC Thermistors (POSISTOR®) “Micro Heater” (Flat Thin head Insulated Type)

(Part Number) FT P 18 BC 3R3 Q 03 RT
1. 2. 3. 4. 5. 6 7. 8.

1. Product ID

Product ID	
FT	Flat Thin head Insulated type

2. Series

Code	Series
P	PTC Thermistor

3. Dimensions

Code	Dimensions
18	1.60 × 0.80mm

4. Temperature Characteristics

Code	Temperature Characteristics
BC	Curie Point 95 deg.C

5. Resistance

Expressed by three figures. The unit is (Ω).

The first and second figures are significant digits, and the third figure expresses the number of zeros which follow the two figures. If there is a decimal point, it is expressed by the capital letter “R”. In this case, all figures are significant digits.

Ex.)

Code	Resistance
3R3	3.3 ohm
330	33 ohm

6. Resistance Tolerance

Code	Sensing Temp. Tolerance
Q	+35% / -20%

7. Individual Specifications

Ex.)

Code	Individual Specifications
03	Structure, others

8. Packaging

Code	Packaging
RT	Plastic Taping 4mm Pitch (4000pcs.)

Attention:

This datasheet is downloaded from the website of Murata Manufacturing Co., Ltd. Therefore, it's specifications are subject to change or our products in it may be discontinued without advance notice. Please check with our sales representatives or product engineers before ordering.

3. Specifications

3.1 Line up

Part Number	Resistance Value at 25°C [ohm](*1)	Curie Temp. [deg.C](*2)	Max. Operating Voltage [V]	Operating Temperature Range [deg.C]
FTP18BC2R2Q03RT	2.2ohm +35/-20%	T2R25 = 85~105	DC 2.0	0~+40
FTP18BC3R3Q03RT	3.3ohm +35/-20%	T2R25 = 85~105	DC 3.0	0~+40
FTP18BC4R7Q03RT	4.7ohm +35/-20%	T2R25 = 85~105	DC 3.6	0~+40
FTP18BC180Q03RT	18ohm +35/-20%	T2R25 = 85~105	DC 6.0	0~+40
FTP18BC330Q03RT	33ohm +35/-20%	T2R25 = 85~105	DC 6.0	0~+40
FTP18BC470Q03RT	47ohm +35/-20%	T2R25 = 85~105	DC 6.0	0~+40
FTP18BC680Q03RT	68ohm +35/-20%	T2R25 = 85~105	DC 6.0	0~+40

*1 : After applying maximum voltage for 3 min. at 25 deg.C in still air, keeping at 25 deg.C in still air for more than 24 Hr.

And measure resistance by 4 terminal method with less than 10mA (less than 0.1VDC) of DC voltage.

*2 : After changing ambient temperature in air oven, the resistance is measured by 4 terminal method with less than 10mA (less than 0.1VDC) of DC voltage.

Curie temperature is specified the temperature when the resistance becomes twice of the resistance at 25 deg.C.

Attention:

This datasheet is downloaded from the website of Murata Manufacturing Co., Ltd.
Therefore, it's specifications are subject to change or our products in it may be discontinued without advance notice.
Please check with our sales representatives or product engineers before ordering.

3.2 Resistance-Temperature Characteristics Typical Curve

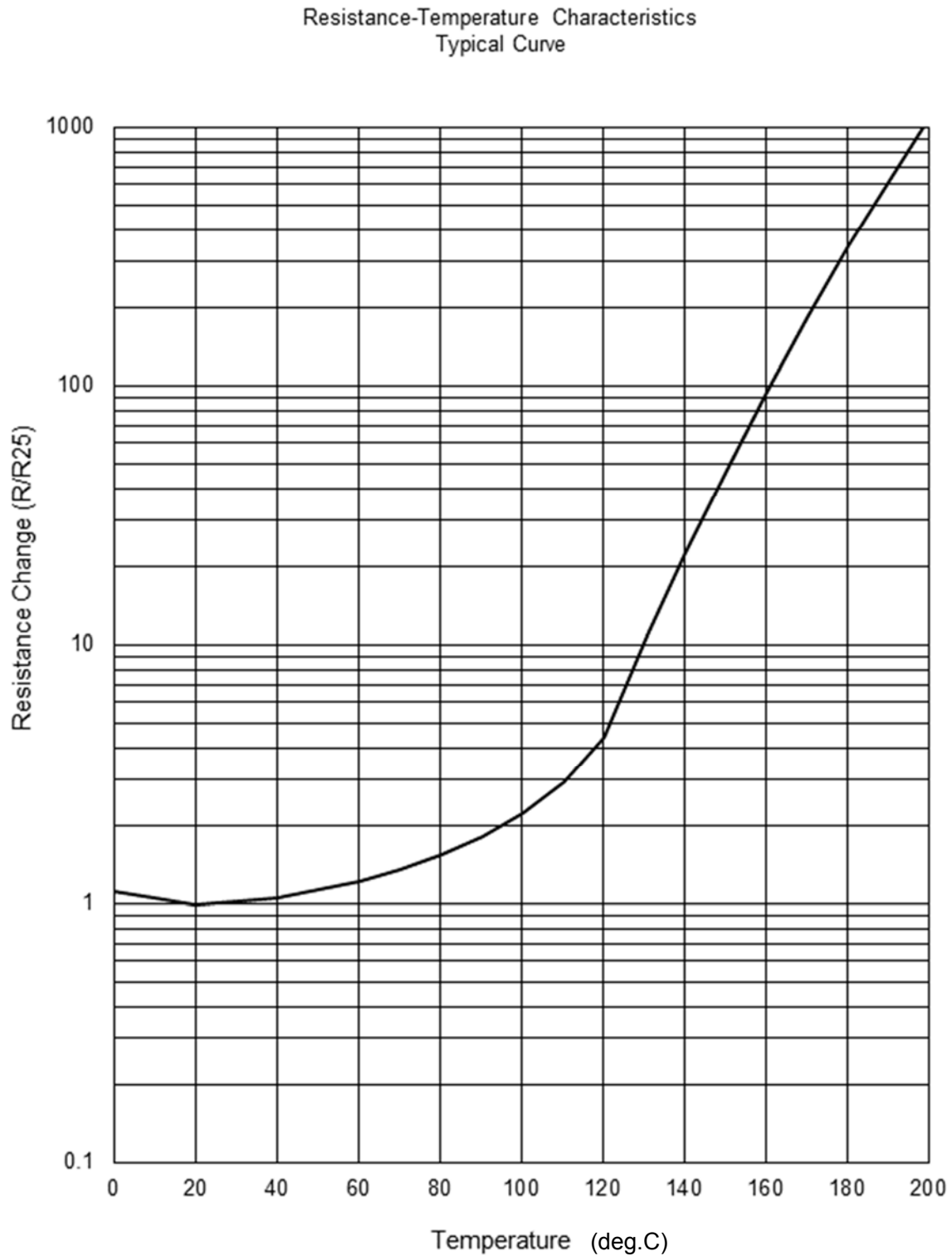

Attention:

This datasheet is downloaded from the website of Murata Manufacturing Co., Ltd. Therefore, its specifications are subject to change or our products in it may be discontinued without advance notice. Please check with our sales representatives or product engineers before ordering.

3.3 Reliability Tests

	Item	Criteria	Method of test
1	Dry heat	No visible damage.	45±2 deg.C in air, for 500 +48/-0h without loading.
2	Cold	Resistance(R25) change rate : less than ±20%	-0 +0/-3 deg.C in air, for 500 +48/-0h without loading.
3	Damp heat		60±2 deg.C, 90 ~ 95%RH in air, for 500 +48/-0h without loading.
4	High temperature with continuous load		45±2 deg.C in air, PTC is applied with max. voltage for 500+48/-0h.

*R25 is zero-power resistance at 25 deg.C.

- After each test, tested sample should be kept for more than 1 h at room temperature (normal humidity and normal atmospheric pressure). After that, the resistance should be measured.

Attention:

This datasheet is downloaded from the website of Murata Manufacturing Co., Ltd.
Therefore, it's specifications are subject to change or our products in it may be discontinued without advance notice.
Please check with our sales representatives or product engineers before ordering.

4. Fundamental Data

4.1 Experimental Setup

Figure 1 shows experimental setup.

Aluminum plate (L: 10mm / W:10mm / H:0.1mm) is used as standard material.

Micro heater is mounted on FPC.

FPC is put on Aluminum plate by thermal conductivity double side tape,

Ambient temperatures are room temperature at 26 deg.C / 15deg.C / 5 deg.C .

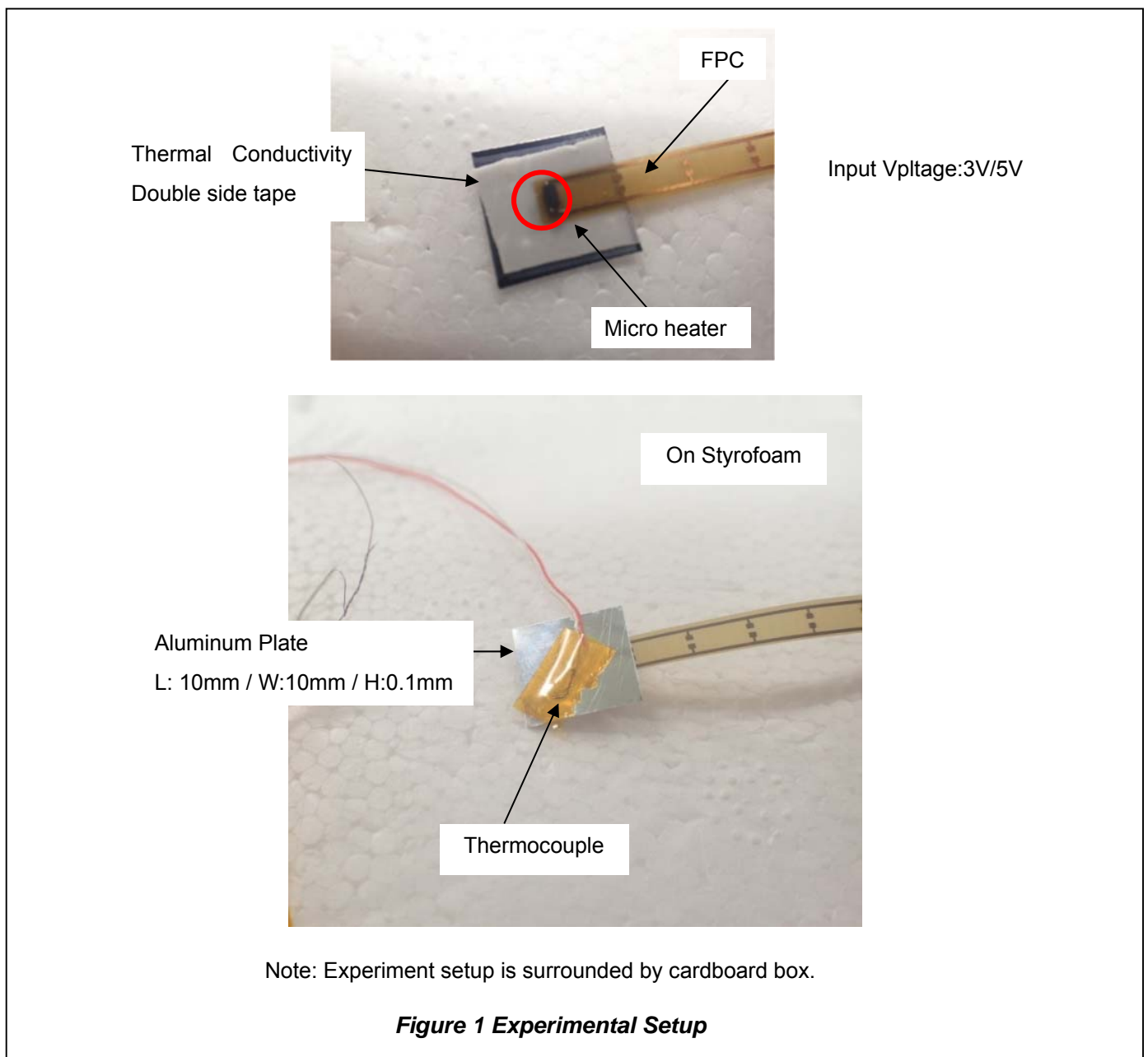

Attention:

This datasheet is downloaded from the website of Murata Manufacturing Co., Ltd. Therefore, it's specifications are subject to change or our products in it may be discontinued without advance notice. Please check with our sales representatives or product engineers before ordering.

4.2 Experiment Data (Temperature rise vs. Time)

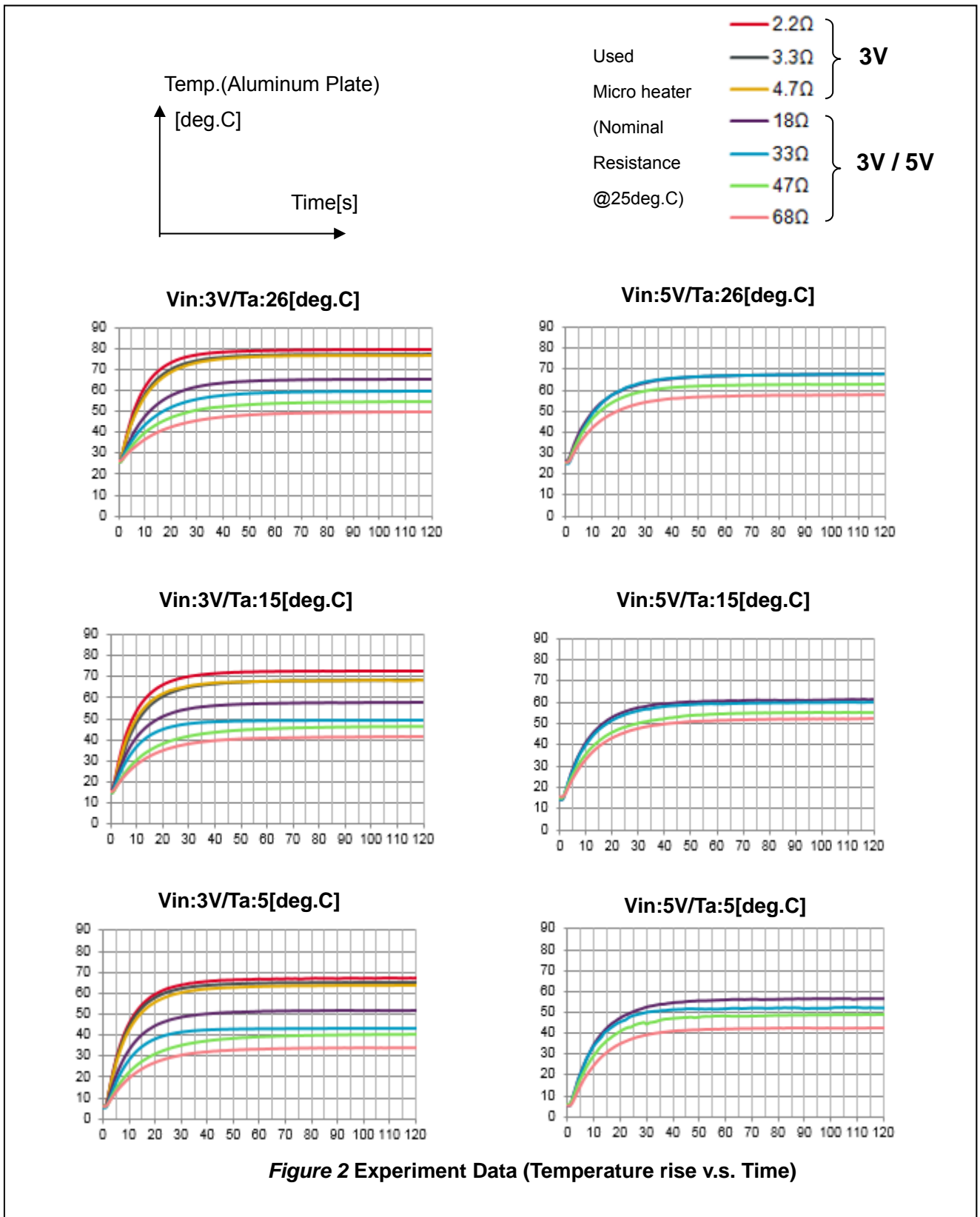

Attention:

This datasheet is downloaded from the website of Murata Manufacturing Co., Ltd. Therefore, its specifications are subject to change or our products in it may be discontinued without advance notice. Please check with our sales representatives or product engineers before ordering.

4.3 Experiment Data (Summary)

(*1)Calculated Value by
nominal resistance

Vin:3V/Ta:26deg.C

Nominal Resistance[ohm]	Temp.(sat.)(deg.C)	Time (to 40deg.C)[s]	I(sat.)(mA)	Inrush Current[mA>(*1)
2.2	80	3	69	1364
3.3	78	4	65	909
4.7	77	4	64	638
18	66	6	48	167
33	60	8	40	91
47	55	10	32	64
68	50	15	27	44

Vin:3V/Ta:15deg.C

Nominal Resistance[ohm]	Temp.(sat.)(deg.C)	Time (to 40deg.C)[s]	I(sat.)(mA)	Inrush Current[mA>(*1)
2.2	72	6	72	1364
3.3	68	7	68	909
4.7	68	7	65	638
18	58	10	51	167
33	50	13	44	91
47	47	25	36	64
68	42	43	29	44

Vin:3V/Ta:5deg.C

Nominal Resistance[ohm]	Temp.(sat.)(deg.C)	Time (to 40deg.C)[s]	I(sat.)(mA)	Inrush Current[mA>(*1)
2.2	67	8	77	1364
3.3	65	9	75	909
4.7	64	9	69	638
18	52	15	55	167
33	43	24	48	91
47	41	84	38	64
68	34	-	31	44

Attention:

This datasheet is downloaded from the website of Murata Manufacturing Co., Ltd. Therefore, its specifications are subject to change or our products in it may be discontinued without advance notice. Please check with our sales representatives or product engineers before ordering.

Vin:5V/Ta:26deg.C

Nominal Resistance[ohm]	Temp.(sat.)(deg.C)	Time (to 40deg.C)[s]	I(sat.)(mA)	Inrush Current[mA>(*1)
18	68	6	32	278
33	67	6	33	152
47	63	7	29	106
68	58	9	24	74

Vin:5V/Ta:15deg.C

Nominal Resistance[ohm]	Temp.(sat.)(deg.C)	Time (to 40deg.C)[s]	I(sat.)(mA)	Inrush Current[mA>(*1)
18	62	9	36	278
33	60	10	34	152
47	56	13	29	106
68	52	16	27	74

Vin:5V/Ta:5deg.C

Nominal Resistance[ohm]	Temp.(sat.)(deg.C)	Time (to 40deg.C)[s]	I(sat.)(mA)	Inrush Current[mA>(*1)
18	57	13	39	278
33	52	14	39	152
47	49	19	33	106
68	43	33	28	74

Attention:

This datasheet is downloaded from the website of Murata Manufacturing Co., Ltd. Therefore, it's specifications are subject to change or our products in it may be discontinued without advance notice. Please check with our sales representatives or product engineers before ordering.

5. Dimension, Land Pattern

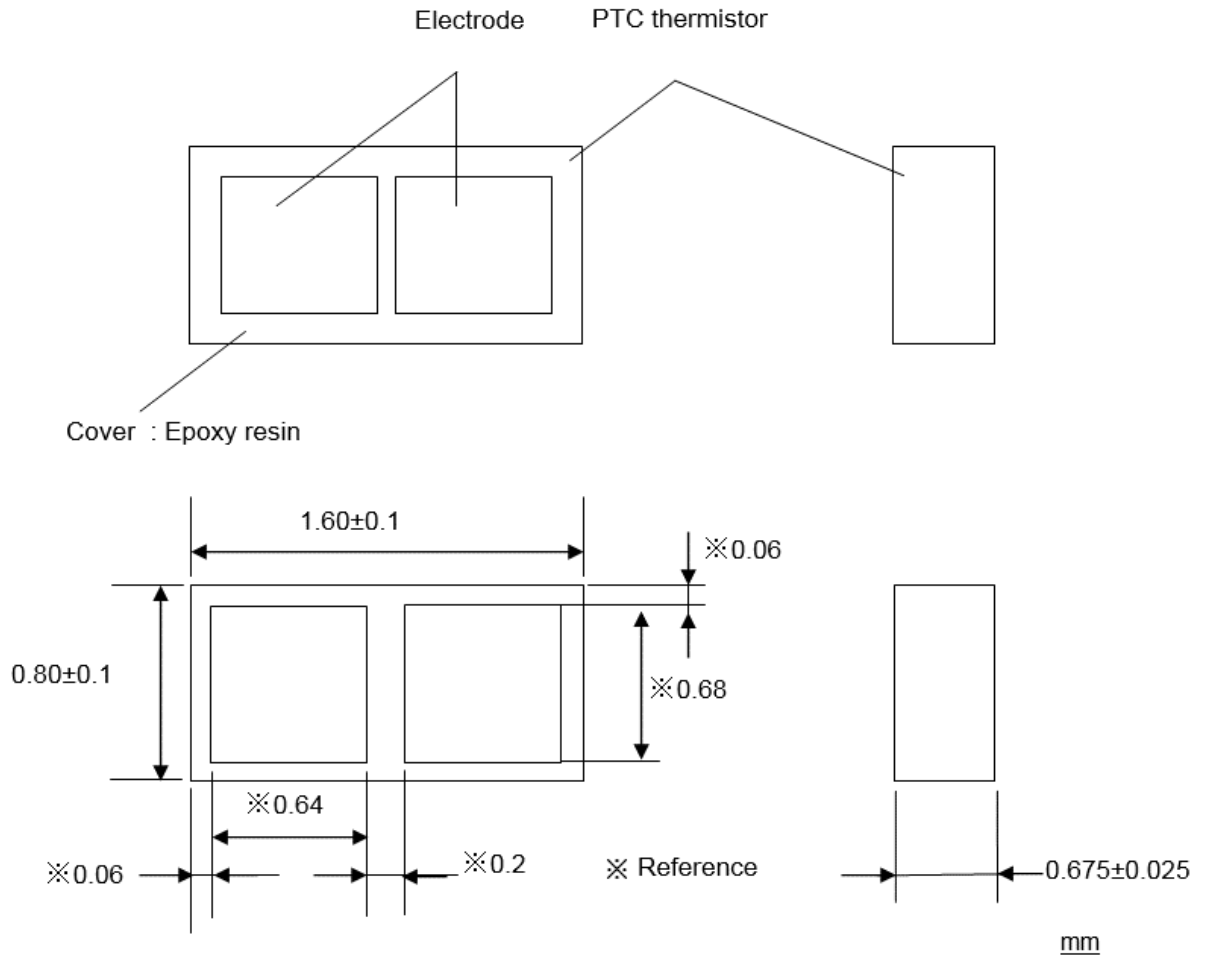

Attention:

This datasheet is downloaded from the website of Murata Manufacturing Co., Ltd. Therefore, its specifications are subject to change or our products in it may be discontinued without advance notice. Please check with our sales representatives or product engineers before ordering.

6. Packing

6.1 Taping Specification

6.1.1 Dimensions of plastic tape

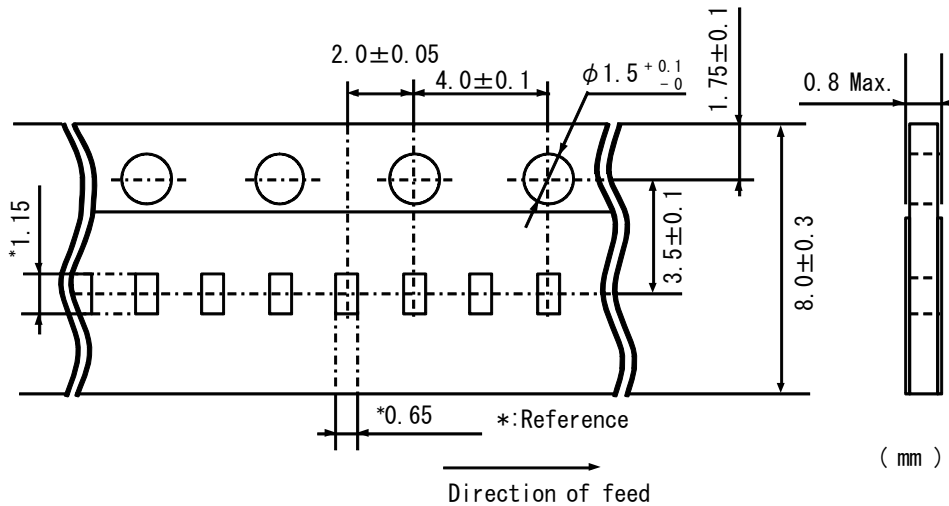

- (1) Products shall be packaged in the cavity of the base tape and sealed by top tape and bottom tape.
- (2) Top tape and bottom tape have no joints and products shall be packaged and sealed in the cavity of the base tape, continuously.

6.1.2 Tape strength

- (1) Pull strength of top tape and bottom tape shall be specified as follows:

Size[mm/in.]	Plastic tape	Cover tape
1608/0402	5N minimum	5N minimum

- (2) Peeling force of top tape

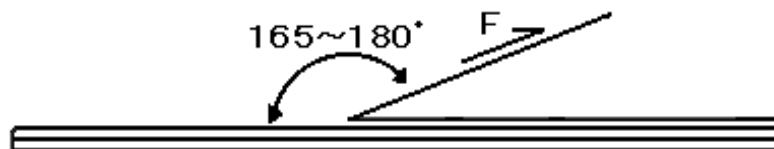

- *1 peeling angle: 165 to 180 degree against the fixed surface of tape.
- *2 peeling speed: 300mm/min.
- *3 Peeling force: 0.1 ~ 0.6 N

Attention:

This datasheet is downloaded from the website of Murata Manufacturing Co., Ltd. Therefore, it's specifications are subject to change or our products in it may be discontinued without advance notice. Please check with our sales representatives or product engineers before ordering.

6.2 Reeling

6.1.1 Quantity (Standard Quantity)

Part Number	Products quantity in a reel
FTP18BC***Q03RT	4,000 pcs. /reel

(2) A tape in a reel contains Leader unit and Trailer unit where products are not packed.

(See the following figure.)

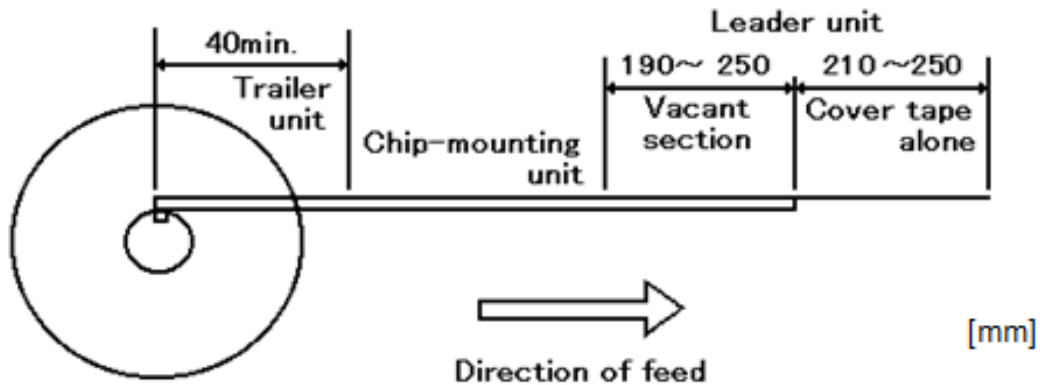

* The reeling specification above shall not be applied for the order less than Standard Quantity.

(3) The plastic tape and cover tape are not attached at the end of the tape (Vacant section) for a minimum of 5 pitches.

(4) A label shall be attached on the reel.

(MURATA's part number, inspection number and quantity shall be marked on the label.)

(5) Dimensions of reel.

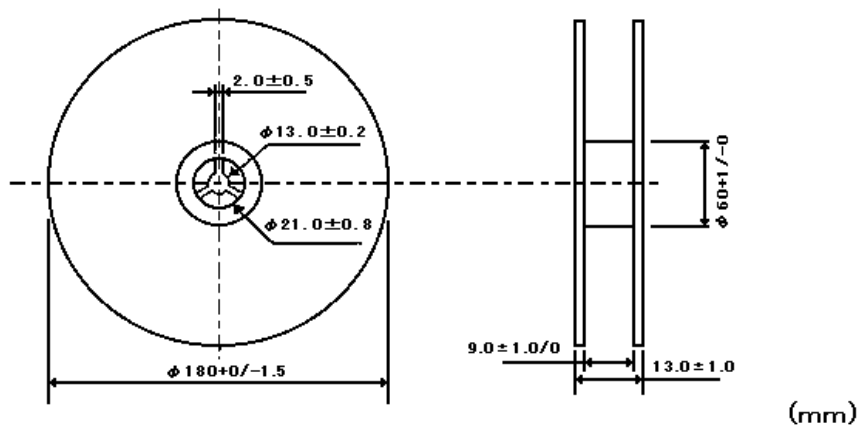

6.1.2 Packing

The reeling shall be packed in a package. The label shall be attached on the package.

(Customer's name, order number, customer's part number, MURATA's part number and quantity shall be marked on a label.)

Attention:

This datasheet is downloaded from the website of Murata Manufacturing Co., Ltd. Therefore, it's specifications are subject to change or our products in it may be discontinued without advance notice. Please check with our sales representatives or product engineers before ordering.

7. Caution



1. Applying the voltage exceeding the specified 'Maximum Voltage' may causes deterioration of the characteristics or destruction of this product. Do not apply the voltage exceeding the 'Maximum Voltage'.
2. Do not use PTC Thermistor under the following environments because all these factors can deteriorate the characteristics of product or can cause the failures and the burning-out.
 - (1) Corrosive or dioxidizing gas atmosphere (Ex. Cl₂, H₂S, NH₃, SO_x, NO_x, etc.)
(Ex. Resistance abnormality, Emit smoke, Ignition)
 - (2) Volatile or flammable gas (Ex. Resistance abnormality, Emit smoke, Ignition)
 - (3) Dusty place (Ex. Short)
 - (4) Under vacuum, reducing pressure or under high-pressure (Ex. Resistance abnormality)
 - (5) Place with salt water, oils, chemical liquids or organic solvents
(Ex. Resistance abnormality, Short)
 - (6) Place strongly vibrated (Ex. Open)
 - (7) Other place, where is similar like the above-mentioned environments
3. Please install PTC thermistor in order not to touch directly. Because PTC thermistor becomes high temperature when voltage is applied.
4. Though the top surface of PTC thermistor is insulated, the insulation of the bottom of PTC thermistor is not enough due to exposure of electrical wiring and so on.
So please ensure proper insulation around PTC thermistor on your product.
5. As the surface temperature of PTC thermistor is changed by the usage condition like thermal load etc. please use the temperature control circuit with PTC thermistor in case that severe temperature control is required.
6. Please contact us before using this product for the under-mentioned applications requiring, especially high reliability, in order to prevent defects which might directly cause damage to other party's life, body or property. (Listed below.)

(1) Aircraft equipment	(6) Transportation equipment (automobiles, trains, ships, etc.)
(2) Aerospace equipment	(7) Traffic signal equipment
(3) Undersea equipment	(8) Disaster prevention / Crime prevention equipment
(4) Power plant control equipment	(9) Data-processing equipment
(5) Medical equipment	(10) Applications of similar complexity or with reliability requirement comparable to the applications listed in the above
7. Be sure to provide an appropriate fail-safe function on your product to prevent a second damage that may be caused by the abnormal function or the failure of our product.

Attention:

This datasheet is downloaded from the website of Murata Manufacturing Co., Ltd.
Therefore, it's specifications are subject to change or our products in it may be discontinued without advance notice.
Please check with our sales representatives or product engineers before ordering.

Notice

1. Use this product within the specified temperature range. Higher temperature may cause deterioration of the characteristics or the material quality of this product.
2. Following conditions should be kept in order to avoid deterioration of solderability of outer electrodes and the characteristics of this products, because this is MOISTURE SENSITIVE DEVICES.



MOISTURE SENSITIVE DEVICES

(1) Calculated shelf life in sealed bag: 6 months at -10 to 40 deg.C and <75% relative humidity (RH).
This product should be treated as MSL3 of JEDEC J-STD-020D.1.

(2) Storage Place: Store this product in no corrosive gas (SOX, Cl, etc.), nor directly under sunshine.

3. Solder and Flux

(1) Solder Paste

Reflow Soldering : Use solder paste.

For your reference, we are using the solder paste below for any internal tests of this product.

- M705 solder paste (Sn:Ag:Cu=96.5wt%:3.0wt%:0.5wt%)

(Manufactured by Senju Metals Industry Co., Ltd.)

(2) Flux : Use rosin type flux in soldering process. If below flux is used, some problems might be caused in the product characteristics and reliability. Please do not use below flux.

- Strong acidic flux (with halide content exceeding 0.1wt%).
- Water-soluble flux(*Water-soluble flux can be defined as non rosin type flux including wash-type flux and non-wash-type flux.)

4. For removing the flux after soldering, observe the following points in order to avoid deterioration of the characteristics or any change of the outer electrodes quality.

(1) Cleaning Conditions

- Please keep mounted parts and a substrate from an occurrence of resonance in ultrasonic cleaning.
- Please do not clean the products in the case of using a non-washed type flux.

(2) Drying : Please fully perform cleaning and keep flux and cleaner components from remaining.

After cleaning, dry promptly this product.

5. Do not give this product a strong press-force nor a mechanical shock. Because such mechanical forces may cause cracking or chipping of this product.

6. In your mounting process, observe the following points in order to avoid deterioration of the characteristics or destruction of this product. The mounting quality of this product may also be affected by the mounting conditions, shown the points below.

Attention:

This datasheet is downloaded from the website of Murata Manufacturing Co., Ltd.
Therefore, it's specifications are subject to change or our products in it may be discontinued without advance notice.
Please check with our sales representatives or product engineers before ordering.

- (1) Please mount this product by soldering. When mounted by other methods, such as conductive adhesives, please contact us in advance.
- (2) Recommendable Land Size (All dimensions in mm)
Please be careful that dimension of land pattern may cause the inclination or lift of products mounting.

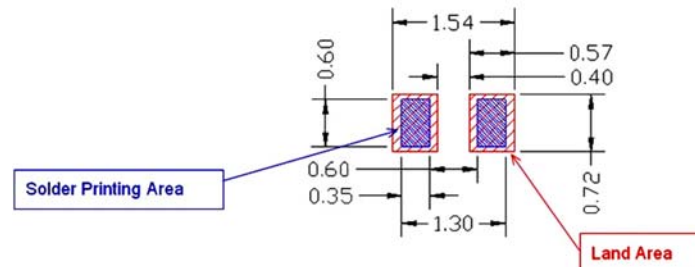

(3) Printing Condiiti

- i. Recommendable thickness of solder paste printing shall be 80-100 μ m.
- ii. Please be careful that too much solder cause Solder bridges.

(4) Recommendable Temperature Profile for Soldering

- i. Insufficient preheating may cause a crack on body. The difference between preheating temperature and soldering temperature shall be less than 100 deg.C.
- ii. Rapid cooling by dipping in solvent or by other means is not recommended.

<Recommended Soldering Condition>

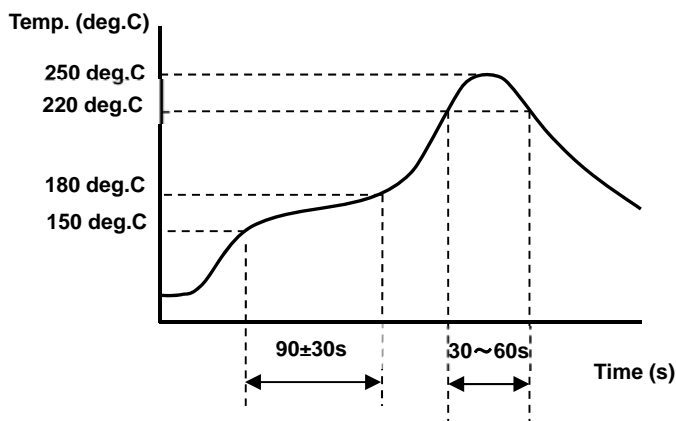

Preheating: 160 +/- 10 deg.C, 1min. ~ 2 min.
Heating : 220 deg.C, 30 – 60 sec
Peak temp. : 250 deg.C

- (5) There is a fear of unexpected failures (insufficient solder-wetting, etc.) in your mounting process, caused by the mounting conditions. Please evaluate if this product is correctly mounted under your mounting conditions.

Attention:

This datasheet is downloaded from the website of Murata Manufacturing Co., Ltd. Therefore, it's specifications are subject to change or our products in it may be discontinued without advance notice. Please check with our sales representatives or product engineers before ordering.



1. Please make sure that your product has been evaluated in view of your specifications with our product being mounted to your product.
2. You are requested not to use our product deviating from the agreed specifications.
3. Please return one duplicate of this product specification to us with your signature to a knowledge your receipt. If the duplicate is not returned by appointed day, the product specification will be deemed to have been received by you.
4. We consider it not appropriate to include any terms and conditions with regard to the business transaction in the product specifications, drawings or other technical documents. Therefore, if your technical documents as above include such terms and conditions such as warranty clause, product liability clause, intellectual property infringement liability clause, or export control clause, they will be deemed to be invalid.

Attention:

This datasheet is downloaded from the website of Murata Manufacturing Co., Ltd. Therefore, it's specifications are subject to change or our products in it may be discontinued without advance notice. Please check with our sales representatives or product engineers before ordering.