



ENERGY RECOVERY PRODUCTS™



ESM020 10-20 W
ESM030 21-30 W
ESM040 31-40 W
ESM050 41-50 W

Tri-Mode Dimming (0-10 V & TRIAC/ELV) Constant Current LED Drivers with Fast Startup Time

| Input Voltage | Max. Output Power | Output Voltage | Output Current | Efficiency | Max. Case Temperature | THD | Power Factor | Dimming Method | Dimming Range | Startup Time |
|-----------------------|-------------------|----------------|--------------------|---------------|---------------------------------|-------|--------------|--|----------------------|--------------|
| 90 to 305 Vac maximum | 50 W | 19 to 56 Vdc | 350 mA to 1.4 A CC | ≥ 87% typical | 90°C (measured at the hot spot) | < 20% | > 0.9 | Forward-Phase, Reverse-Phase & 0 - 10V | 1 - 100% (% of Iout) | 300 ms |

CC: Constant Current

PRODUCT DESCRIPTION

The ESM series of LED drivers is ideally suited for LED lighting applications in office, commercial and residential. These devices are compatible with most industry standard phase-cut wall-based dimmers, both forward-phase (leading-edge) and reverse-phase (trailing edge), and 0-10V wall-based dimmers and offer deep dimming from 100% down to 1%.

FEATURES

- Compatible with TRIAC (forward-phase or leading-edge) / ELV (reverse-phase or trailing-edge) and 0-10 V dimmers
- TRIAC dimming only at 120 Vac
- Linear 0-10V dimming transfer function: 10V=100%, 1V=10%, 0.1V=1%
- Lifetime: 85,500 hours at 70°C case hot spot temperature (39°C ambient temperature) for ESM050W-1200-42 (50 W)
- Protections: output open load, over-current and short-circuit (hiccup), and over-temperature with auto recovery
- Conducted and radiated EMI: Compliant with FCC CFR Title 47 Part 15 Class B (120 Vac)/Class A (277 Vac) and EN55015 (CISPR 15) at 220/230/240 Vac
- Enables ENERGY STAR® and DLC (DesignLight Consortium®) luminaire compliance
- IP64-rated case with silicone-based potting
- 90°C maximum case hot spot temperature
- Class 2 power supply
- Double-insulated power supply between input and output (class II)
- Worldwide safety approvals

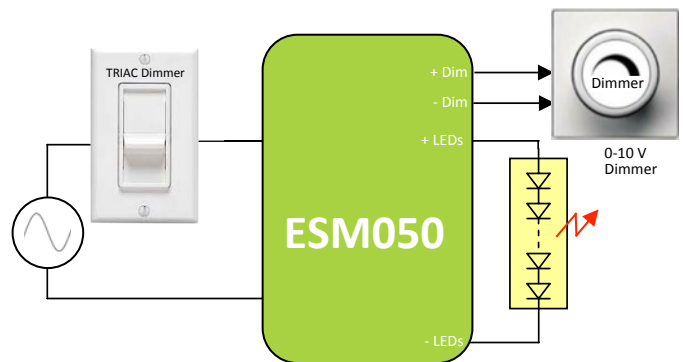

APPLICATION DIAGRAM



METAL CASE:
 L 110 x W 60 x H 26 mm
 (L 4.33 x W 2.36 x H 1.02 in)

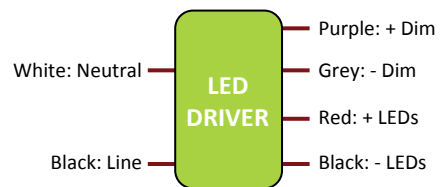

WIRING DIAGRAM

APPLICATIONS

- Recessed lighting (downlights)
- Commercial & Residential lighting
- Office lighting





ENERGY RECOVERY PRODUCTS™



ESM020 10-20 W
ESM030 21-30 W
ESM040 31-40 W
ESM050 41-50 W

Tri-Mode Dimming (0-10 V & TRIAC/ELV) Constant Current LED Drivers with Fast Startup Time

I - INPUT SPECIFICATION (@25°C ambient temperature)

| | Units | Minimum | Typical | Maximum | Notes |
|---|--|---------|-------------------------|--|--|
| Input Voltage Range (Vin) | Vac | 90 | 120/220/230/ 240/277 | 305 | The rated output current for each model is achieved at Vin ≥ 108 Vac and at Vin ≥ 198 Vac, at nominal load. |
| Input Frequency Range | Hz | 47 | 60 | 63 | |
| Power Factor (PF) | | 0.9 | > 0.9 | | At nominal input voltage and with nominal LED voltage |
| Inrush Current | Meets NEMA-410 requirements | | | | At any point on the sine wave and 25°C |
| Leakage Current | µA | | | 250 µA @ 120 Vac 500 µA @ 230 Vac 600 µA @ 277 Vac | Measured per IEC60950-1 |
| Input Harmonics | Complies with IEC61000-3-2 for Class C equipment | | | | |
| Total Harmonics Distortion (THD) | | | | 20% | •At nominal input voltage and nominal LED voltage •Complies with DLC (DesignLight Consortium) technical requirements v2.0 |
| Efficiency | % | - | 87% | - | Measured with nominal input voltage, a full sinusoidal wave form and without dimmer connected |
| Isolation | Meets UL60950-1 for class II reinforced/double insulation power supply | | | | |

2 - OUTPUT SPECIFICATION (@25°C ambient temperature)

| | Units | Minimum | Typical | Maximum | Notes |
|----------------------------------|--|---------|---------|---------|---|
| Output Voltage (Vout) | Vdc | 19 | | 56 | See ordering information for details |
| Output Current (Iout) | mA | 350 | | 1400 | •See ordering information for details •The rated output current for each model is achieved at Vin ≥ 108 Vac and at Vin ≥ 198 Vac, at nominal load. |
| Output Current Regulation | % | -5 | ±2.5 | 5 | Includes AC line voltage, load, and current set point variations |
| Output Current Overshoot | % | - | - | 10 | The driver does not operate outside of the regulation requirements for more than 500 ms during power on with nominal LED load and without dimmer. |
| Ripple Current | ≤ 33% of rated output current for each model | | | | •Measured at nominal LED voltage and nominal input voltage without dimming. •Calculated in accordance with the IES Lighting Handbook, 9th edition. |
| Dimming Range (% of Iout) | % | 1 | | 100 | The dimming range will be dependent on each specific dimmer. |
| Start-up Time | ms | | 300 | | With nominal LED voltage and without dimmer attached |
| | | | 400 | | With nominal LED voltage, with an approved dimmer attached (see list of approved dimmers in page 5) and at the full dimming conduction angle |

Output Controls

| | |
|---------------------------------|---|
| +Dim Signal, -Dim Signal | The +Dim/-Dim signal pins can be used to adjust the output setting via a standard commercial wall dimmer, an external control voltage source (0 to 10 Vdc), or a variable resistor when using the recommended number of LEDs. The dimming input permits 1% to 100% dimming. |
|---------------------------------|---|



ENERGY RECOVERY PRODUCTS™



ESM020 10-20 W
ESM030 21-30 W
ESM040 31-40 W
ESM050 41-50 W

Tri-Mode Dimming (0-10 V & TRIAC/ELV) Constant Current LED Drivers with Fast Startup Time

3 - ENVIRONMENTAL CONDITIONS

| | Units | Minimum | Typical | Maximum | Notes |
|--|--|---------|---------|---------|---|
| Operating Case Temperature (Tc) | °C | -30 | | +90 | Case temperature measured at the hot spot •tc (see label in page 11) |
| Storage Temperature | °C | -40 | | +85 | |
| Humidity | % | 5 | - | 95 | Non-condensing |
| Cooling | Convection cooled | | | | |
| Acoustic Noise | dBA | | | 22 | Measured at a distance of 1 foot (30 cm) without and with approved dimmers |
| Mechanical Shock Protection | per EN60068-2-27 | | | | |
| Vibration Protection | per EN60068-2-6 & EN60068-2-64 | | | | |
| MTBF | > 300,000 hours when operated at nominal input and output conditions, and at Tc ≤ 70°C | | | | |
| Lifetime (See graphs "Lifetime vs. Case and Ambient Temperature" in section 6) | <ul style="list-style-type: none"> •85,500 hours at Tc = 70°C (Tambient = 39.2°C) for ESM050W-1200-42 (50.4 W) •74,000 hours at Tc = 70°C (Tambient = 56°C) for ESM040W-0700-56 (39.2 W) •Measured at the hot spot (see hot spot •tc on label in page 11) | | | | |

4 - EMC COMPLIANCE AND SAFETY APPROVALS

| EMC Compliance | | | |
|---|--|--|---|
| Conducted and Radiated EMI | <ul style="list-style-type: none"> •FCC CFR Title 47 Part 15 Class B at 120 Vac and Class A at 277 Vac, •EN55015 (CISPR 15) compliant at 220/230/240 Vac | | |
| Harmonic Current Emissions | IEC61000-3-2 | For Class C equipment | |
| Voltage Fluctuations & Flicker | IEC61000-3-3 | | |
| Immunity Compliance | ESD (Electrostatic Discharge) | IEC61000-4-2 | 6 kV contact discharge, 8 kV air discharge, level 3 |
| | RF Electromagnetic Field Susceptibility | IEC61000-4-3 | 3 V/m, 80 - 1000 MHz, 80% modulated at a distance of 3 meters |
| | Electrical Fast Transient | IEC61000-4-4 | ± 2 kV on AC power port for 1 minute, ±1 kV on signal/control lines |
| | Surge | IEC61000-4-5 | ± 1 kV line to line (differential mode) / ± 2 kV line to common mode ground (tested to secondary ground) on AC power port, ±0.5 kV for outdoor cables |
| | Conducted RF Disturbances | IEC61000-4-6 | 3 V, 0.15-80 MHz, 80% modulated |
| | Voltage Dips | IEC61000-4-11 | >95% dip, 0.5 period; 30% dip, 25 periods; 95% reduction, 250 periods |
| Transient Protection | Ring Wave | ANSI/IEEE c62.41.1-2002 & c62.41.2-2002 category A, 2.5 kV ring wave | |

| Safety Agency Approvals | | |
|-------------------------|---|----------------------|
| UL | UL8750 recognized | UL60950-1 recognized |
| cUL | CSA C22.2 60950-1 | |
| CE | IEC61347-2-13 electronic control gear for LED Modules | |

| Safety | | | | | |
|--------------------------------|-------|---------|---------|---------|---|
| | Units | Minimum | Typical | Maximum | Notes |
| Hi Pot (High Potential) | Vdc | 4242 | | | <ul style="list-style-type: none"> •Insulation between the input (AC line and Neutral) and the output •Tested at the RMS voltage equivalent of 3000 Vac |



ENERGY RECOVERY PRODUCTS™



| | |
|---------------|---------|
| ESM020 | 10-20 W |
| ESM030 | 21-30 W |
| ESM040 | 31-40 W |
| ESM050 | 41-50 W |

Tri-Mode Dimming (0-10 V & TRIAC/ELV) Constant Current LED Drivers with Fast Startup Time

■ 5 - PROTECTION FEATURES

Under-Voltage (Brownout)

The ESM series provides protection circuitry such that an application of an input voltage below the minimum stated in paragraph 1 (Input Specification) shall not cause damage to the driver.

Short Circuit

The ESM series is protected against short-circuit such that a short from any output to return shall not result in a fire hazard or shock hazard. The driver shall hiccup as a result of a short circuit or over current fault. Removal of the fault will return the driver to within normal operation. The driver shall recover, with no damage, from a short across the output for an indefinite period of time.

Internal Over temperature Protection

The ESM series incorporates circuitry that prevents internal damage due to an over temperature condition. An over temperature condition may be a result of an excessive ambient temperature or as a result of an internal failure. When the over temperature condition is removed, the driver shall automatically recover.

Output Open Load

When the LED load is removed, the output voltage of the ESM series is limited to 1.3 times the maximum output voltage of each model.



ENERGY RECOVERY PRODUCTS™



ESM020 10-20 W
ESM030 21-30 W
ESM040 31-40 W
ESM050 41-50 W

Tri-Mode Dimming (0-10 V & TRIAC/ELV) Constant Current LED Drivers with Fast Startup Time

6 - PREDICTED LIFETIME VERSUS CASE AND AMBIENT TEMPERATURE

Lifetime is defined by the measurement of the temperatures of all the electrolytic capacitors whose failure would affect light output under the nominal LED load and worst case AC line voltage. The graph in figure 1 is determined by the electrolytic capacitor with the shortest lifetime, among all electrolytic capacitors. The lifetime of an electrolytic capacitor is measured when any of the following changes in performance are observed:

- 1) Capacitance changes more than 20% of initial value
- 2) Dissipation Factor ($\tan \delta$): 150% or less of initial specified value
- 3) Equivalent Series Resistance (ESR): 150% or less of initial specified value
- 4) Leakage current: less of initial specified value

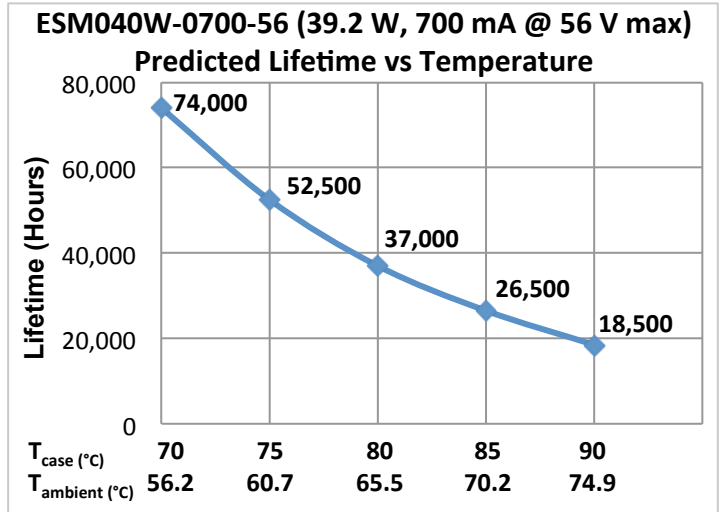
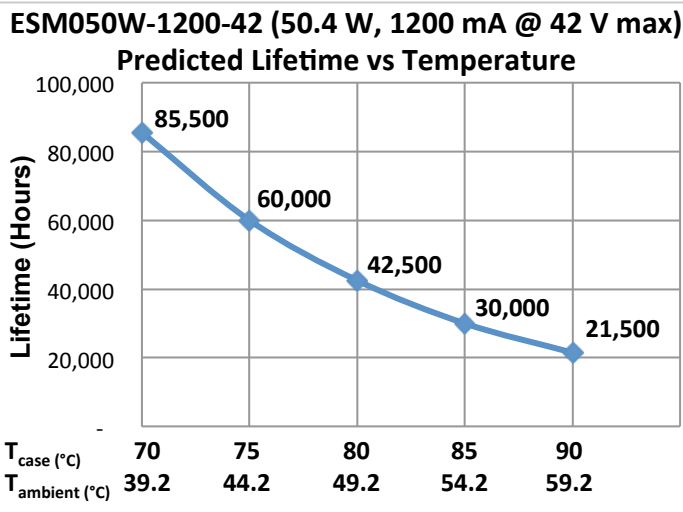

Figure 1

It should be noted the graph "Lifetime vs. Ambient Temperature" may have an error induced in the final application if the mounting has restricted convection flow around the case. For applications where this is evident, the actual case temperature measured at the T_c point in the application should be used for reliability calculations.



ENERGY RECOVERY PRODUCTS™



ESM020 10-20 W
ESM030 21-30 W
ESM040 31-40 W
ESM050 41-50 W

Tri-Mode Dimming (0-10 V & TRIAC/ELV) Constant Current LED Drivers with Fast Startup Time

7 - PHASE-CUT DIMMING

Dimming of the driver is possible with standard TRIAC-based incandescent dimmers that chop the AC voltage as shown in Figure 2, or with ELV dimmers. During the rapid rise time of the AC voltage when the dimmer turns on, the driver does not generate any voltage or current oscillations, and inrush current is controlled. During the on-time of the AC input, the driver regulates the output current based upon the conduction angle. The RMS value of the driver output current is proportional to the on-time of the AC input voltage. When operating with an incandescent dimmer, the RMS output current varies depending upon the conduction angle and RMS value of the applied AC input voltage. Figure 3 shows the typical output current versus conduction angle at nominal input voltage.

TRIAC dimming is only offered at 120 Vac.

The ESM020/030/040/050 series offers dual dimming compatibility with both phase-cut (reverse-phase and forward-phase) and 0–10V dimmers. Phase-cut dimming always has priority over 0-10 V dimming.

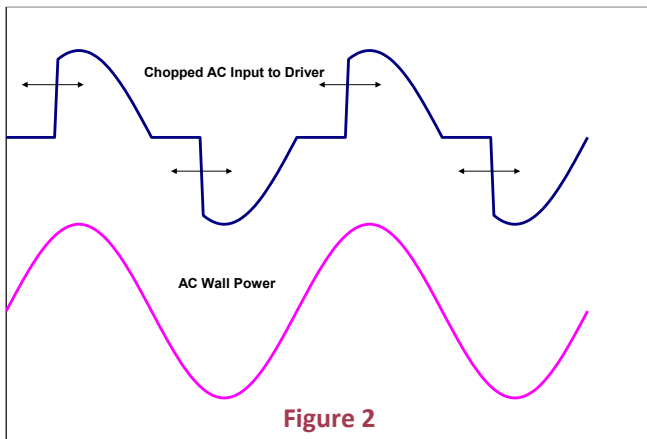

Figure 2

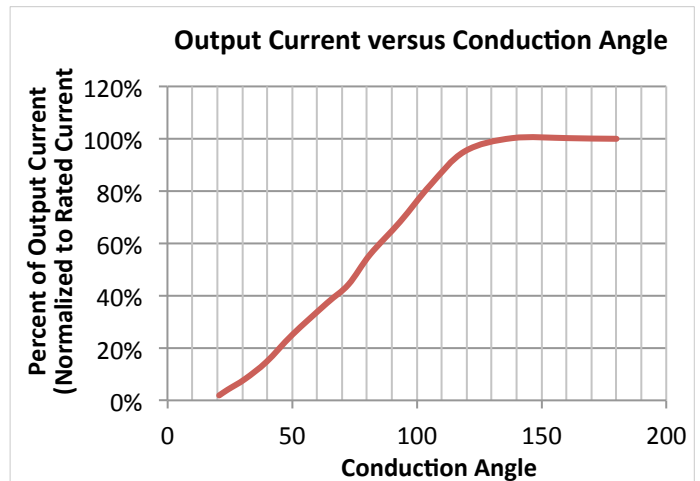

Figure 3

8 - COMPATIBLE PHASE-CUT DIMMERS & DIMMING RANGE

| 120Vac Dimmers | | | | | |
|----------------|-----------|---------|------------|------------|-----------|
| Mfg. | Model | Mfg. | Model | Mfg. | Model |
| Lutron | S-603PG | Lutron | DVELV-303P | Lutron | CT-103P |
| Leviton | IPI06-1LZ | Lutron | SELV-300P | Cooper | SLC03P |
| Leviton | 6631-2 | Leviton | 6683-IW | Leviton | IPE04 |
| Lutron | DVCL-153P | Leviton | 6161 | Lutron | MAELV-600 |
| Lutron | DV-600P | Leviton | 6633-P | Lutron | FAELV-500 |
| Lutron | TGCL-153P | Lutron | TG-600P | Lightolier | ZP260QEW |
| Lutron | S-600P | Cooper | DLC03P | Cooper | DAL06P |
| Leviton | VPE06 | Lutron | LG-600P | | |



ENERGY RECOVERY PRODUCTS™



| | |
|---------------|---------|
| ESM020 | 10-20 W |
| ESM030 | 21-30 W |
| ESM040 | 31-40 W |
| ESM050 | 41-50 W |

Tri-Mode Dimming (0-10 V & TRIAC/ELV) Constant Current LED Drivers with Fast Startup Time

9 - 0-10V DIMMING

The ESM drivers operate only with 0-10V dimmers that sink current. They are not designed to operate with 0-10V control systems that source current, as used in theatrical/entertainment systems. Developed in the 1980's, the 0-10V sinking current control method is adopted by the International Electrotechnical Commission (IEC) as a part of their IEC Standard 60929 Annex E.

The method to dim the output current of the driver is done via the +Dim/-Dim Signal pins. The +Dim/-Dim Signal pins respond to a 0 to 10 V signal, delivering 1% to 100% of the output current based on rated current for each model. A pull-up resistor is included internal to the driver. When the +Dim input (purple) is short circuited to the -Dim wire (grey) or to the -LED wire (black), there is no output current. When the +Dim input (purple) is ≤ 1 V, the output current is programmed to $\leq 10\%$ of rated current. If the +Dim input is >10 V or open circuited, the output current is programmed to 100% of the rated current.

When not used, the -Dim wire (grey) and to the +Dim wire (purple) can be capped or cut off. In this configuration, no dimming is possible and the driver delivers 100% of its rated output current.

The maximum source current (flowing from the driver to the 0-10V dimmer) supplied by the +Dim Signal pin is < 1 mA. The tolerance of the output current while being dimmed shall be $\pm 8\%$ typical until down to 2V.

There are two 0-10V dimming transfer functions available, a linear curve where 10V = 100% of the output current and 1V = 10% of the output current (seen in figure 4) or a non-linear curve where the 9V = 100% of the output current and 1V = 1% of the output current (seen in figure 5).

The non-linear curve is recommended when using standard in wall 0-10V logarithmic dimmers to avoid having insufficient source current available to pull the dimmer up to 10V and to account for the inability of the dimmer to pull below approximately 0.9V. In these types of installations, the modified transfer function will ensure 100% light output and dimming to 1%, regardless of the number of drivers on the 0-10V dimming line.

Normalized Output Current vs Dimming Voltage

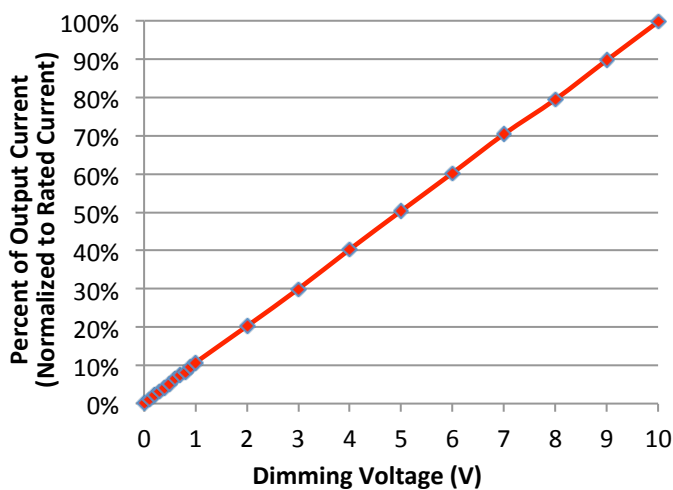

Figure 4

Normalized Output Current vs Dimming Voltage

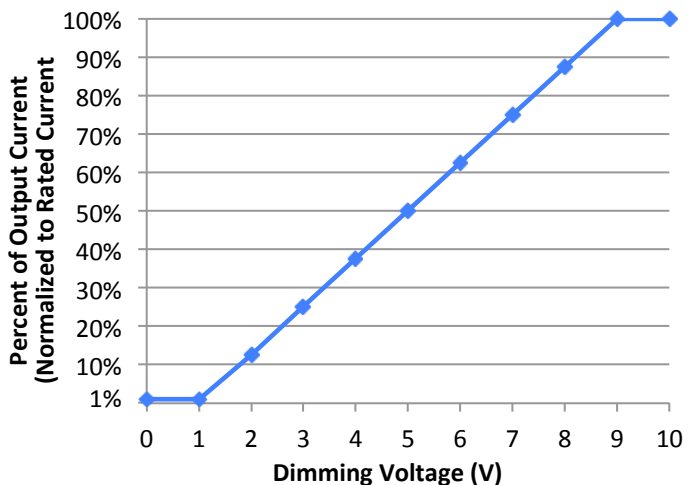

Figure 5



ENERGY RECOVERY PRODUCTS™



| | |
|---------------|---------|
| ESM020 | 10-20 W |
| ESM030 | 21-30 W |
| ESM040 | 31-40 W |
| ESM050 | 41-50 W |

Tri-Mode Dimming (0-10 V & TRIAC/ELV) Constant Current LED Drivers with Fast Startup Time

9 - 0-10V DIMMING (CONTINUED)

A fixed or variable resistor can be also used from the dimming input to the return to adjust the output current. Figure 6 show the relationship of the output current to a resistor connected across the 0-10V dimming input

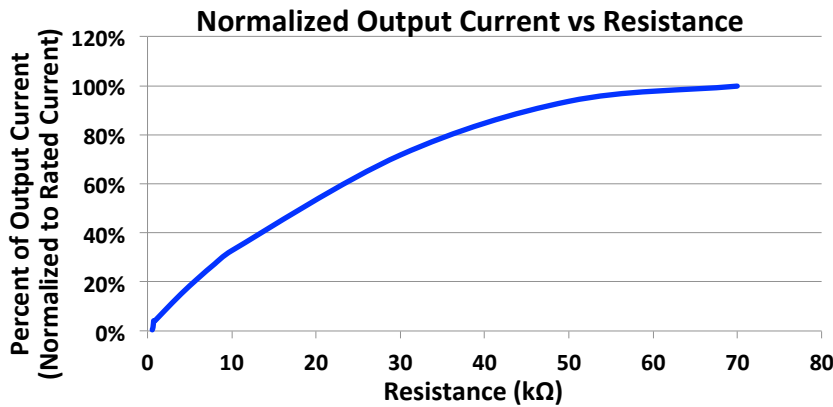

Figure 6

10 - COMPATIBLE 0-10V DIMMERS

- Lutron, Nova series (part number NFTV)
- Lutron, Diva series (part number DVTV)
- Leviton, IllumaTech series (part number IP710-DL)



ENERGY RECOVERY PRODUCTS™



| | |
|---------------|----------------|
| ESM020 | 10-20 W |
| ESM030 | 21-30 W |
| ESM040 | 31-40 W |
| ESM050 | 41-50 W |

Tri-Mode Dimming (0-10 V & TRIAC/ELV) Constant Current LED Drivers with Fast Startup Time

II - MECHANICAL DETAILS

- Packaging Options:** Metal case
- I/O Connections:** Flying leads, 18 AWG on power leads, 18 AWG on control leads, 203 mm (8 in) long, 105°C rated, stranded, stripped by approximately 9.5mm, and tinned. All the wires, on both input and output, have a 300 V insulation rating.
- Ingress Protection:** IP20 rated

I2 - OUTLINE DRAWINGS

Dimensions: L 110 x W 60 x H 26 mm (L 4.33 x W 2.36 x H 1.02 in)

Volume: 171.6 cm³ (10.47 in³)

Weight:

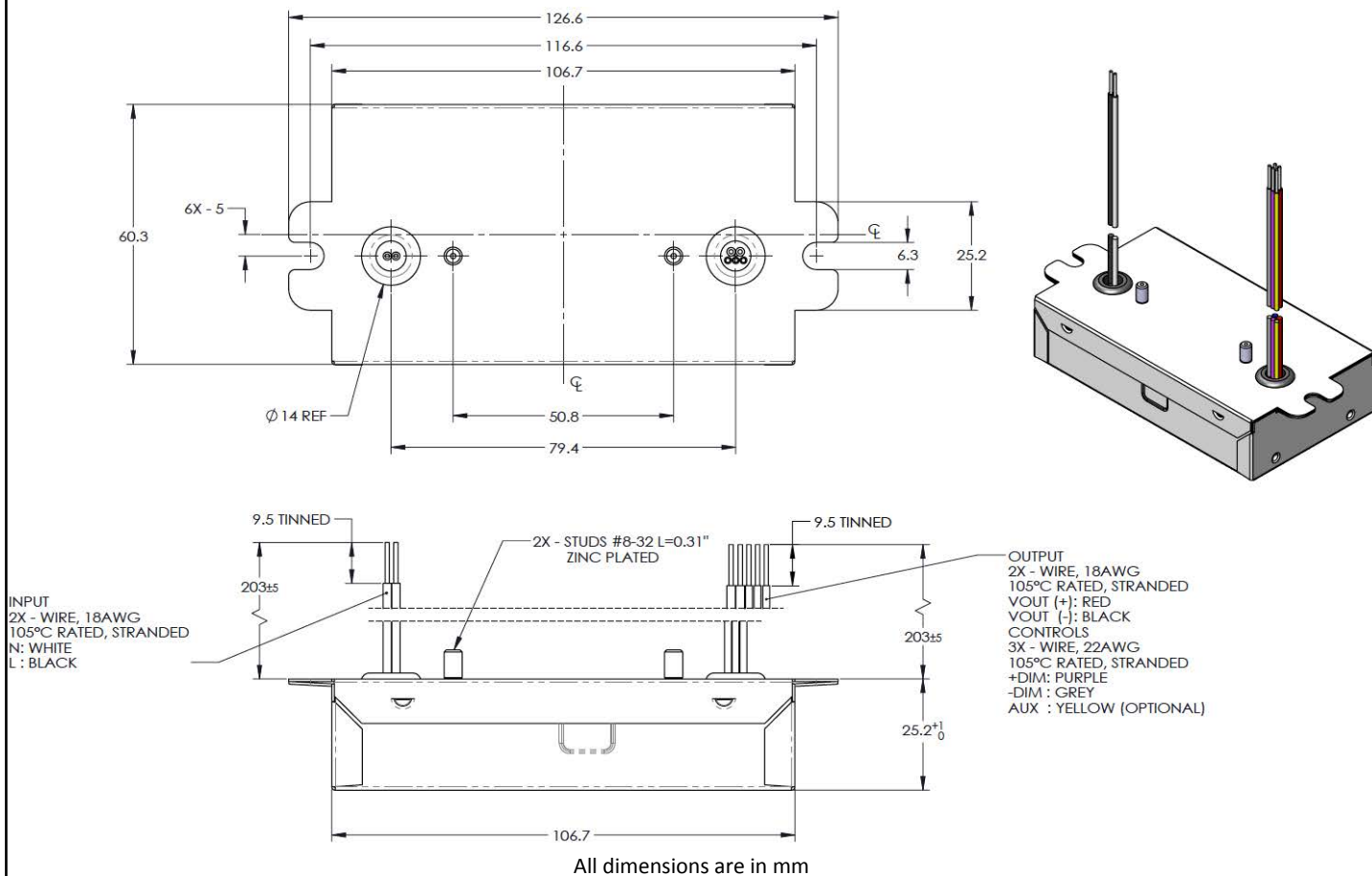

Figure 7



ENERGY RECOVERY PRODUCTS™



ESM020 10-20 W
ESM030 21-30 W
ESM040 31-40 W
ESM050 41-50 W

Tri-Mode Dimming (0-10 V & TRIAC/ELV) Constant Current LED Drivers with Fast Startup Time

13 - ORDERING INFORMATION - MODEL DESCRIPTION

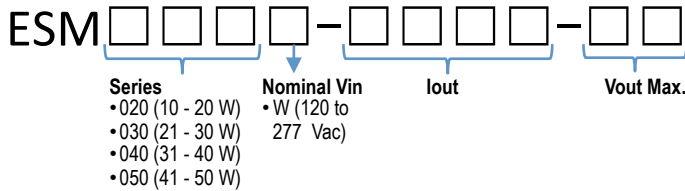

| ERP Part Number | Nominal Input Voltage (Vac) | Iout (mA) | Max Output Power (W) | Vout Min (Vdc) | Vout Nom (Vdc) | Vout Max (Vdc) | No Load Voltage (Vdc) |
|---------------------------------------|-----------------------------|-----------|----------------------|----------------|----------------|----------------|-----------------------|
| ESM020W: 12-20W | | | | | | | |
| ESM020W-0280-42 | 120 - 277 | 280 | 11.8 | 24 | 37.8 | 42 | 50 |
| ESM020W-0350-42 | 120 - 277 | 350 | 14.7 | 24 | 37.8 | 42 | 50 |
| ESM020W-0440-25-SS-F1B ^[1] | 120 - 277 | 440 | 11.0 | 19 | 22.5 | 25 | 32.5 |
| ESM020W-0440-34-SS-F1B ^[2] | 120 - 277 | 440 | 15.0 | 27 | 30.6 | 34 | 44.2 |
| ESM020W-0440-34 | 120 - 277 | 440 | 15.0 | 19 | 30.6 | 34 | 44.2 |
| ESM030W: 21-30W | | | | | | | |
| ESM030W-0500-42 | 120 - 277 | 500 | 21.0 | 24 | 37.8 | 42 | 50 |
| ESM030W-0550-42 | 120 - 277 | 550 | 23.1 | 24 | 37.8 | 42 | 50 |
| ESM030W-0700-32 | 120 - 277 | 700 | 22.4 | 21 | 28.8 | 32 | 41.6 |
| ESM030W-0700-42 | 120 - 277 | 700 | 29.4 | 24 | 37.8 | 42 | 50 |
| ESM030W-0900-26 | 120 - 277 | 900 | 23.4 | 19 | 24 | 26 | 33.8 |
| ESM030W-0940-26-SS-F1B ^[3] | 120 - 277 | 940 | 24.4 | 19 | 24 | 26 | 33.8 |
| ESM040W: 31-40W | | | | | | | |
| ESM040W-0700-56 | 120 - 277 | 700 | 39.2 | 40 | 50.4 | 56 | 60 |
| ESM040W-0800-42 | 120 - 277 | 800 | 33.6 | 24 | 37.8 | 42 | 50 |
| ESM040W-0850-42 | 120 - 277 | 850 | 35.7 | 24 | 37.8 | 42 | 50 |
| ESM040W-0900-42 | 120 - 277 | 900 | 37.8 | 24 | 37.8 | 42 | 50 |
| ESM040W-0940-33-SS-F1B ^[4] | 120 - 277 | 940 | 31.0 | 28 | 29.7 | 33 | 42.9 |
| ESM040W-0940-43 | 120 - 277 | 940 | 40.4 | 35 | 38.7 | 43 | 50 |
| ESM050W: 41-50W | | | | | | | |
| ESM050W-1050-42 | 120 - 277 | 1050 | 44.1 | 24 | 37.8 | 42 | 50 |
| ESM050W-1200-42 | 120 - 277 | 1200 | 50.4 | 24 | 37.8 | 42 | 50 |
| ESM050W-1400-34 | 120 - 277 | 1400 | 47.6 | 23 | 30.6 | 34 | 44.2 |

For additional options of output current and output voltage, contact your sales representative or send an email to: SaveEnergy@ERPpowerllc.com

Notes:

- (1) The ESM030W-0440-25-SS-F1B is specifically intended to drive the Cree LMH020 850 sunset module and exhibits a customized 0-10V dimming transfer function. It will not work with any other LED or LED string.
- (2) The ESM040W-0440-34-SS-F1B is specifically intended to drive the Cree LMH020 1250 sunset module and exhibits a customized 0-10V dimming transfer function. It will not work with any other LED or LED string.
- (3) The ESM030W-0940-26-SS-F1B is specifically intended to drive the Cree LMH020 2000 sunset module and exhibits a customized 0-10V dimming transfer function. It will not work with any other LED or LED string.
- (4) The ESM040W-0940-33-SS-F1B is specifically intended to drive the Cree LMH020 3000 sunset module and exhibits a customized 0-10V dimming transfer function. It will not work with any other LED or LED string.



ENERGY RECOVERY PRODUCTS™



| | |
|---------------|----------------|
| ESM020 | 10-20 W |
| ESM030 | 21-30 W |
| ESM040 | 31-40 W |
| ESM050 | 41-50 W |

Tri-Mode Dimming (0-10 V & TRIAC/ELV) Constant Current LED Drivers with Fast Startup Time

I4 - LABELING

The ESM040W-0800-42 is used in figures 8 & 9 as an example to illustrate a typical label.

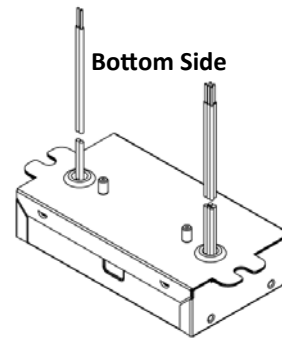
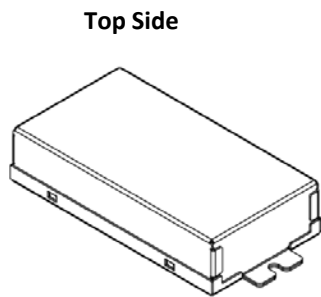

ESM040W-0800-42
Dimmable Constant Current LED Driver
Max case temperature $t_c = 90^\circ\text{C}$
Class II
Suitable for operation with a TRIAC dimmer
Suitable for dry or damp locations

AC INPUT:
120-277 V ~ 0.70 A
50/60 Hz
PF ≥ 0.9
THD $\leq 20\%$
L-BLACK
N-WHITE

Designed in the USA
Made in China

DC OUTPUT:
Regulated current 800 mA \equiv
Maximum power 33.6 W
Voltage range 24-42 Vdc
No load voltage 50 Vdc
+ RED
- BLACK
+ DIM: PURPLE
- DIM: GREY
(For 0-10V dimming)

t_c

Figure 8

ESM040W-0800-42

| | |
|--|--|
| <p>AC INPUT: 120-277 V ~ 0.70 A 50/60 Hz PF ≥ 0.9 THD $\leq 20\%$</p> <p>L-BLACK N-WHITE</p> | <p>DC OUTPUT: Regulated current 800 mA \equiv Maximum power 33.6 W Voltage range 24-42 Vdc No load voltage 50 Vdc</p> <p>+ RED - BLACK + DIM: PURPLE - DIM: GREY (For 0-10V dimming)</p> |
|--|--|

Figure 9

USA Headquarters
Tel: +1-805-517-1300
Fax: +1-805-517-1411
301 Science Drive, Suite 210
Moorpark, CA 93021, USA

CHINA Operations
Tel: +86-756-6266298
Fax: +86-756-6266299
No. 8 Pingdong Road 2
Zhuhai, Guangdong, China 519060

ERP - Energy Recovery Products (ERP Power, LLC) - reserves the right to make changes without further notice to any products herein. ERP makes no warranty, representation or guarantee regarding the suitability of its products for any particular purpose, nor does ERP assume any liability arising out of the application or use of any product or circuit, and specifically disclaims any and all liability, including without limitation special, consequential or incidental damages. "Typical" parameters which may be provided in ERP data sheets and/or specifications can and do vary in different applications and actual performance may vary over time. All operating parameters, including "Typicals" must be validated for each customer application by customer's technical experts. ERP does not convey any license under its patent rights nor the rights of others. ERP products are not designed, intended, or authorized for use as components in systems intended for surgical implant into the body, or other applications intended to support or sustain life, or for any other application in which the failure of the ERP product could create a situation where personal injury or death may occur. Should Buyer purchase or use ERP products for any such unintended or unauthorized application, Buyer shall indemnify and hold ERP and its officers, employees, subsidiaries, affiliates, and distributors harmless against all claims, costs, damages, and expenses, and reasonable attorney fees arising out of, directly or indirectly, any claim of personal injury or death associated with such unintended or unauthorized use, even if such claim alleges that ERP was negligent regarding the design or manufacture of the part. ERP is an Equal Opportunity/Affirmative Action Employer. This literature is subject to all applicable copyright laws and is not for resale in any manner.