

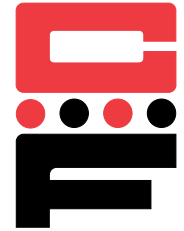

Self-Clinching Nuts

Series C & CS



C & CS nuts provide strong load-bearing threads in sheet metal and other thin section assemblies. Some C & CS nuts meet specification features of NASM45938/1.

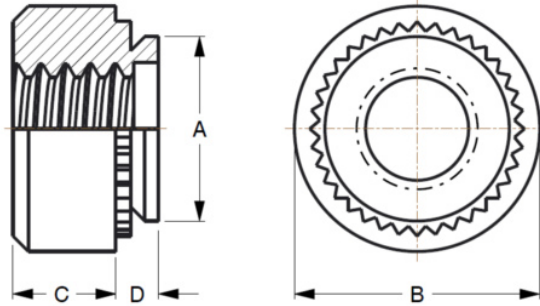

Series	Material	Finish
C	Heat-treated Carbon Steel	Zinc* Clear
CS	300 Series Stainless Steel	Passivated ASTM A967

*See Finish Spec. on Page 6.

Thread: Internal 2B, ANSI B1.1 (6H, ANSI/ASME B1.13M).

Use In: C – Materials with HRB-80 or less.

CS – Materials with HRB-70 or less.

Dimensions & Specifications

Thread Size	Part Number		D Max.	Min.	+.003 in. -.000	A Max.	B ±.01 in.	C ±.01 in.	Min.
	Carbon Steel	Stainless Steel							
#2-56	C256-0	CS256-0	.030	.030	.166	.165	.250	.070	.19
	C256-1	CS256-1	.038	.040					
	C256-2	CS256-2	.054	.056					
	C256-3	CS256-3	.087	.090					
#3-48	C348-0	CS348-0	.030	.030	.166	.165	.250	.070	.19
	C348-1	CS348-1	.038	.040					
	C348-2	CS348-2	.054	.056					
	C348-3	CS348-3	.087	.090					
#4-40	C440-0	CS440-0	.030	.030	.166	.165	.250	.070	.19
	C440-1	CS440-1	.038	.040					
	C440-2	CS440-2	.054	.056					
	C440-3	CS440-3	.087	.090					
#6-32	C632-0	CS632-0	.030	.030	.1875	.187	.280	.070	.22
	C632-1	CS632-1	.038	.040					
	C632-2	CS632-2	.054	.056					
	C632-3	CS632-3	.087	.090					
#8-32	C832-0	CS832-0	.030	.030	.213	.212	.310	.090	.27
	C832-1	CS832-1	.038	.040					
	C832-2	CS832-2	.054	.056					
	C832-3	CS832-3	.087	.090					

Continued on next page.

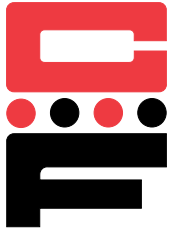

Self-Clinching Nuts

Series C & CS

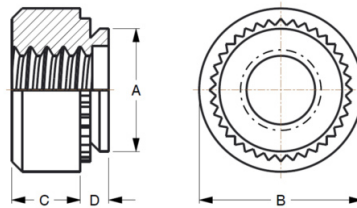
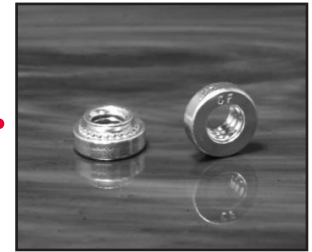

Continued from previous page.

Dimensions & Specifications

Thread Size	Part Number		D Max.	Min.	+0.003 in. -.000	A Max.	B ±.01 in.	C ±.01 in.	Min.
	Carbon Steel	Stainless Steel							
#10-24	C1024-0	CS1024-0	.030	.030	.250	.249	.340	.090	.28
	C1024-1	CS1024-1	.038	.040					
	C1024-2	CS1024-2	.054	.056					
	C1024-3	CS1024-3	.087	.090					
#10-32	C1032-0	CS1032-0	.030	.030	.250	.249	.340	.090	.28
	C1032-1	CS1032-1	.038	.040					
	C1032-2	CS1032-2	.054	.056					
	C1032-3	CS1032-3	.087	.090					
#12-24	C1224-1	CS1224-1	.038	.040	.277	.276	.370	.130	.31
	C1224-2	CS1224-2	.054	.056					
	C1224-3	CS1224-3	.087	.090					
1/4-20	C420-0	CS420-0	.045	.047	.344	.343	.440	.170	.34
	C420-1	CS420-1	.054	.056					
	C420-2	CS420-2	.087	.090					
	C420-3	CS420-3	.120	.125					
1/4-28	C428-1	CS428-1	.054	.056	.344	.343	.440	.170	.34
	C428-2	CS428-2	.087	.090					
	C428-3	CS428-3	.120	.125					
5/16-18	C518-1	CS518-1	.054	.056	.413	.412	.500	.230	.38
	C518-2	CS518-2	.087	.090					
	C518-3	CS518-3	.120	.125					
5/16-24	C524-1	CS524-1	.054	.056	.413	.412	.500	.230	.38
	C524-2	CS524-2	.087	.090					
	C524-3	CS524-3	.120	.125					
3/8-16	C616-1	CS616-1	.087	.090	.500	.499	.560	.270	.44
	C616-2	CS616-2	.120	.125					
	C616-3	CS616-3	.235	.250					
3/8-24	C624-1	CS624-1	.087	.090	.500	.499	.560	.270	.44
	C624-2	CS624-2	.120	.125					
	C624-3	CS624-3	.235	.250					
1/2-13	C813-1	CS813-1	.120	.125	.656	.655	.810	.360	.63
	C813-2	CS813-2	.235	.250					

Continued on next page.



Self-Clinching Nuts

Series C & CS

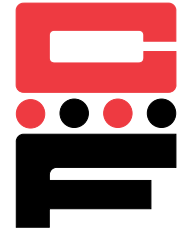

Continued from previous page.

Dimensions & Specifications

Thread Size	Part Number		D Max.	Min.	+0.08 mm -0.00	A Max.	B ±.25 mm	C ±.25 mm	Min.
	Carbon Steel	Stainless Steel							
M2 x 0.4	CM2-0	CSM2-0	.77	.8	4.22	4.20	6.35	1.5	4.8
	CM2-1	CSM2-1	.97	1.0					
	CM2-2	CSM2-2	1.38	1.4					
	CM2-3	CSM2-3	2.21	2.29					
M2.5 x 0.45	CM2.5-0	CSM2.5-0	.77	.8	4.22	4.20	6.35	1.5	4.8
	CM2.5-1	CSM2.5-1	.97	1.0					
	CM2.5-2	CSM2.5-2	1.38	1.4					
	CM2.5-3	CSM2.5-3	2.21	2.29					
M3 x 0.5	CM3-0	CSM3-0	.77	.8	4.22	4.20	6.35	1.5	4.8
	CM3-1	CSM3-1	.97	1.0					
	CM3-2	CSM3-2	1.38	1.4					
	CM3-3	CSM3-3	2.21	2.29					
M3.5 x 0.6	CM3.5-0	CSM3.5-0	.77	.8	4.75	4.73	7.11	1.5	5.6
	CM3.5-1	CSM3.5-1	.97	1.0					
	CM3.5-2	CSM3.5-2	1.38	1.4					
	CM3.5-3	CSM3.5-3	2.21	2.29					
M4 x 0.7	CM4-0	CSM4-0	.77	.8	5.41	5.38	7.87	2.0	6.9
	CM4-1	CSM4-1	.97	1.0					
	CM4-2	CSM4-2	1.38	1.4					
	CM4-3	CSM4-3	2.21	2.29					
M5 x 0.8	CM5-0	CSM5-0	.77	.8	6.35	6.33	8.64	2.0	7.1
	CM5-1	CSM5-1	.97	1.0					
	CM5-2	CSM5-2	1.38	1.4					
	CM5-3	CSM5-3	2.21	2.29					
M6 x 1.0	CM6-0	CSM6-0	1.15	1.2	8.75	8.73	11.18	4.08	8.6
	CM6-1	CSM6-1	1.38	1.4					
	CM6-2	CSM6-2	2.21	2.29					
	CM6-3†	CSM6-3	3.05	3.18					
M8 x 1.25	CM8-1	CSM8-1	1.38	1.4	10.5	10.47	12.7	5.47	9.7
	CM8-2	CSM8-2	2.21	2.29					
	CM8-3†	CSM8-3	3.05	3.2					
M10 x 1.5	CM10-1	CSM10-1	2.21	2.29	14.0	13.97	17.35	7.48	13.5
	CM10-2	CSM10-2	3.05	3.18					
	CM10-3†	CSM10-3†	6.00	6.4					
M12 x 1.75	CM12-1†	CSM12-1†	3.05	3.18	17.0	16.95	20.57	8.5	16
	CM12-2†	CSM12-2†	6.00	6.4					

†Not stocked, available upon special order.

Continued on next page.



Self-Clinching Nuts

Series C & CS

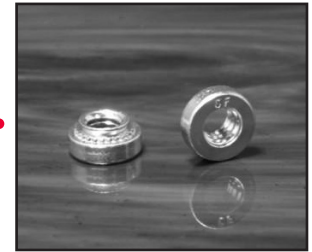

Continued from previous page.

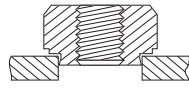

Fastener Must Be Installed
Squarely In Hole

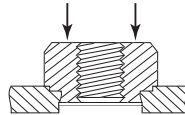

Squeezing Force Is Applied
To Head Of Fastener

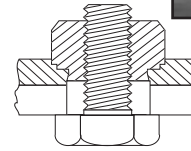

Install Bolt Or Screw
From Opposite Side
Of Head Of Fastener

Installation & Performance Data

Thread Size	Shank Code	Cold-rolled Steel			5052-H34 Aluminum		
		Installation Force (lbs.)	Pushout (lbs.)	Torque-out (in.-lbs.)	Installation Force (lbs.)	Pushout (lbs.)	Torque-out (in.-lbs.)
#2-56 #3-48 #4-40	-0	2500-3500	105	13	1500-2000	63	8
	-1		125	15		90	10
	-2		230	18		170	13
	-3		230	18		170	13
#6-32	-0	3000-6000	110	16	2500-3000	63	16
	-1		130	20		95	17
	-2		275	28		190	22
	-3		275	28		190	22
#8-32	-0	4000-6000	110	26	2500-3000	68	21
	-1		145	35		105	23
	-2		285	45		220	35
	-3		285	45		220	35
#10-24 #10-32	-0	4000-9000	120	30	2500-3000	68	20
	-1		180	40		110	32
	-2		320	60		190	50
	-3		320	60		225	50
#12-24	-1	5000-6500	200	74	2500-6500	120	63
	-2		350	80		285	70
	-3		350	80		285	70
1/4-20 1/4-28	-0	6000-8000	315	115	4000-7000	220	70
	-1		400	150		360	90
	-2-3		400	150		360	125
5/16-18 5/16-24	-1	6000-8000	420	165	4000-7000	380	120
	-2-3		420	180		380	160
3/8-16 3/8-24	-1-2-3	7000-11000	460	320	5000-8000	400	270
	-1-2		10000-15000	1050		735	7000-9000

Continued on next page.



Self-Clinching Nuts

Series C & CS

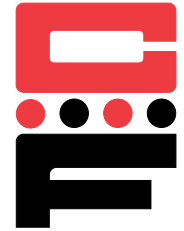

Continued from previous page.

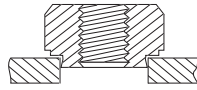

Fastener Must Be Installed
Squarely In Hole

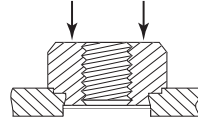

Squeezing Force Is Applied
To Head Of Fastener

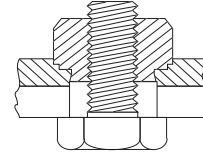

Install Bolt Or Screw
From Opposite Side
Of Head Of Fastener

Installation & Performance Data

Thread Size	Shank Code	Cold-rolled Steel			5052-H34 Aluminum		
		Installation Force (kN)	Pushout (N)	Torque-out (N·m)	Installation Force (kN)	Pushout (N)	Torque-out (N·m)
M2 M2.5 M3	-0	11.2-15.6	470	1.47	6.7-8.9	280	.9
	-1		550	1.7		400	1.13
	-2		1010	2.03		750	1.47
	-3		1100	2.0		850	1.47
M3.5	-0	13.4-26.7	480	1.8	11.2-13.5	280	1.8
	-1		570	2.3		400	1.92
	-2		1210	2.3		840	2.5
	-3		1300	2.5		1050	2.8
M4	-0	18-27	490	2.95	11.2-13.4	300	2.37
	-1		645	4		470	2.6
	-2		1250	5.1		970	4.0
	-3		1300	4.2		1100	4.0
M5	-0	18-38	530	3.6	11.2-15.6	300	3.0
	-1		800	4.5		480	3.6
	-2		1112	6.8		845	5.7
	-3		1500	6.0		1225	5.7
M6	-0	27-36	1380	13	18-32	970	7.9
	-1-2-3		1760	17		1580	10.2 / 14.1
M8	-1-2-3	27-36	1870	18.7 / 20.3	18-32	1570	13.6 / 18.1
M10	-1-2-3	32-50	2020	36.2	22-36	1760	32.7
M12	-1-2	33-49	3065	73.9	23-30	1390	35.2