

DATA SHEET

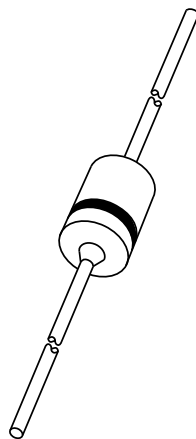

BAV18 to BAV21 General purpose diodes

Product specification
Supersedes data of April 1996
File under Discrete Semiconductors, SC01

1996 Sep 17

General purpose diodes

BAV18 to BAV21

FEATURES

- Hermetically sealed leaded glass SOD27 (DO-35) package
- Switching speed: max. 50 ns
- General application
- Continuous reverse voltage: max. 50 V, 100 V, 150 V, 200 V
- Repetitive peak reverse voltage: max. 60 V, 120 V, 200 V, 250 V
- Repetitive peak forward current: max. 625 mA.

APPLICATIONS

- General purposes in industrial equipment e.g. oscilloscopes, digital voltmeters and video output stages in colour television.

DESCRIPTION

The BAV18, BAV19, BAV20, BAV21 are switching diodes fabricated in planar technology, and encapsulated in hermetically sealed leaded glass SOD27 (DO-35) packages.

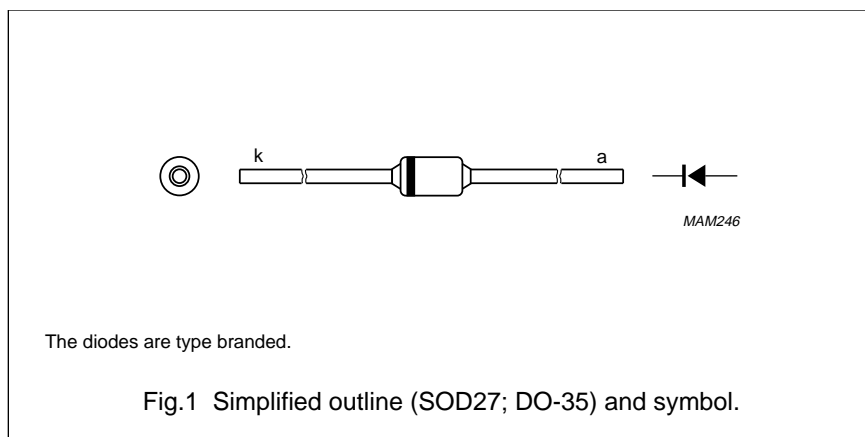

General purpose diodes

BAV18 to BAV21

LIMITING VALUES

In accordance with the Absolute Maximum Rating System (IEC 134).

SYMBOL	PARAMETER	CONDITIONS	MIN.	MAX.	UNIT
V_{RRM}	repetitive peak reverse voltage				
	BAV18		–	60	V
	BAV19		–	120	V
	BAV20		–	200	V
	BAV21		–	250	V
V_R	continuous peak reverse voltage				
	BAV18		–	50	V
	BAV19		–	100	V
	BAV20		–	150	V
	BAV21		–	200	V
I_F	continuous forward current	see Fig.2; note 1	–	250	mA
I_{FRM}	repetitive peak forward current		–	625	mA
I_{FSM}	non-repetitive peak forward current	square wave; $T_j = 25\text{ °C}$ prior to surge; see Fig.4			
		$t = 1\ \mu\text{s}$	–	9	A
		$t = 100\ \mu\text{s}$	–	3	A
		$t = 1\ \text{s}$	–	1	A
P_{tot}	total power dissipation	$T_{amb} = 25\text{ °C}$; note 1	–	400	mW
T_{stg}	storage temperature		–65	+175	°C
T_j	junction temperature		–	175	°C

Note

1. Device mounted on an FR4 printed circuit-board; lead length 10 mm.

General purpose diodes

BAV18 to BAV21

ELECTRICAL CHARACTERISTICS

$T_j = 25\text{ °C}$; unless otherwise specified.

SYMBOL	PARAMETER	CONDITIONS	MIN.	MAX.	UNIT
V_F	forward voltage	see Fig.3 $I_F = 100\text{ mA}$	–	1.0	V
		$I_F = 200\text{ mA}$	–	1.25	V
I_R	reverse current	see Fig.5 $V_R = V_{Rmax}$	–	100	nA
		$V_R = V_{Rmax}; T_j = 150\text{ °C}$	–	100	μA
C_d	diode capacitance	$f = 1\text{ MHz}; V_R = 0$; see Fig.6	–	5	pF
t_{rr}	reverse recovery time	when switched from $I_F = 30\text{ mA}$ to $I_R = 30\text{ mA}; R_L = 100\ \Omega$; measured at $I_R = 3\text{ mA}$; see Fig.8	–	50	ns

THERMAL CHARACTERISTICS

SYMBOL	PARAMETER	CONDITIONS	VALUE	UNIT
$R_{th\ j-tp}$	thermal resistance from junction to tie-point	lead length 10 mm	240	K/W
$R_{th\ j-a}$	thermal resistance from junction to ambient	lead length 10 mm; note 1	375	K/W

Note

1. Device mounted on a printed circuit-board without metallization pad.

General purpose diodes

BAV18 to BAV21

GRAPHICAL DATA

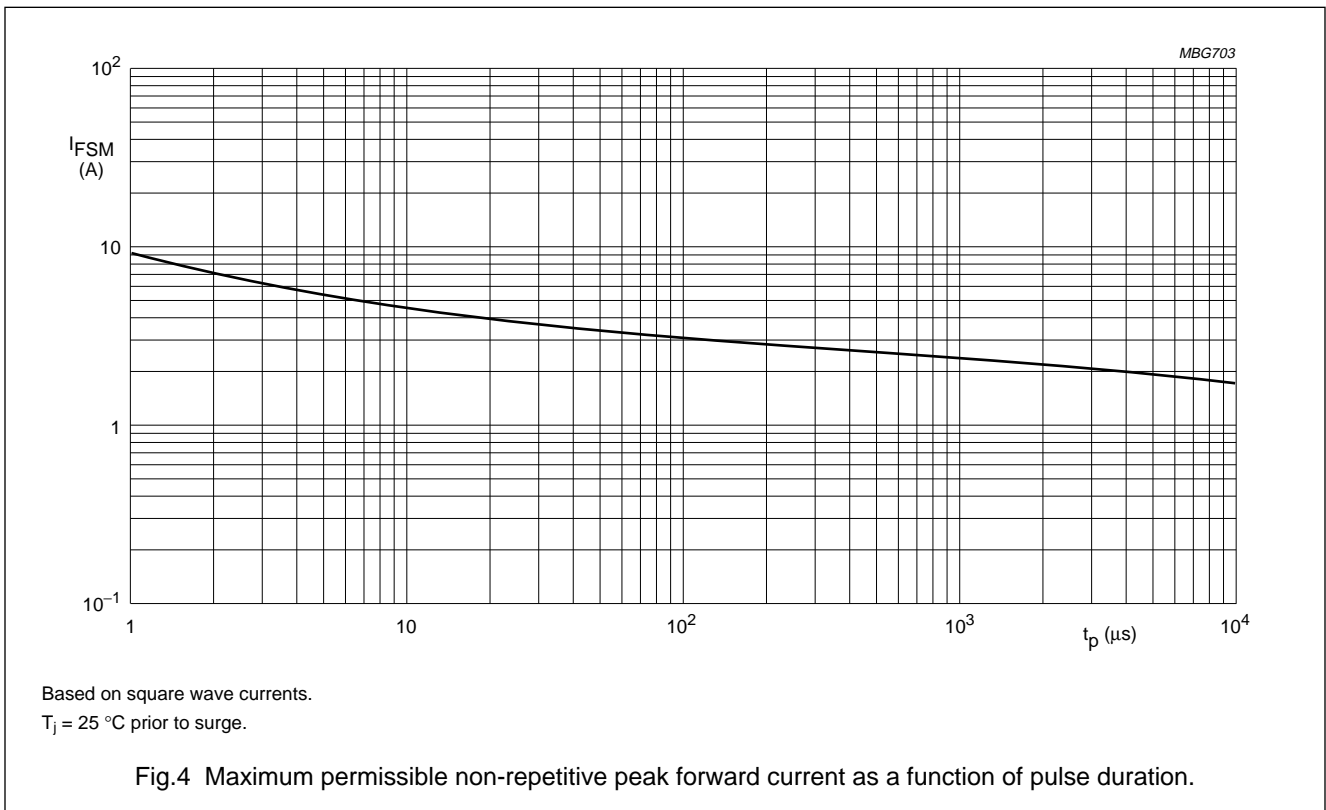
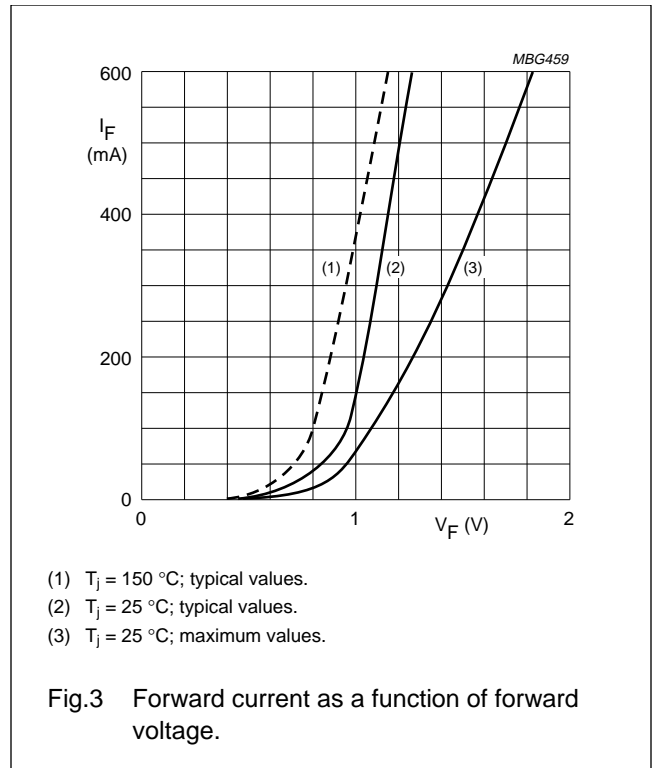
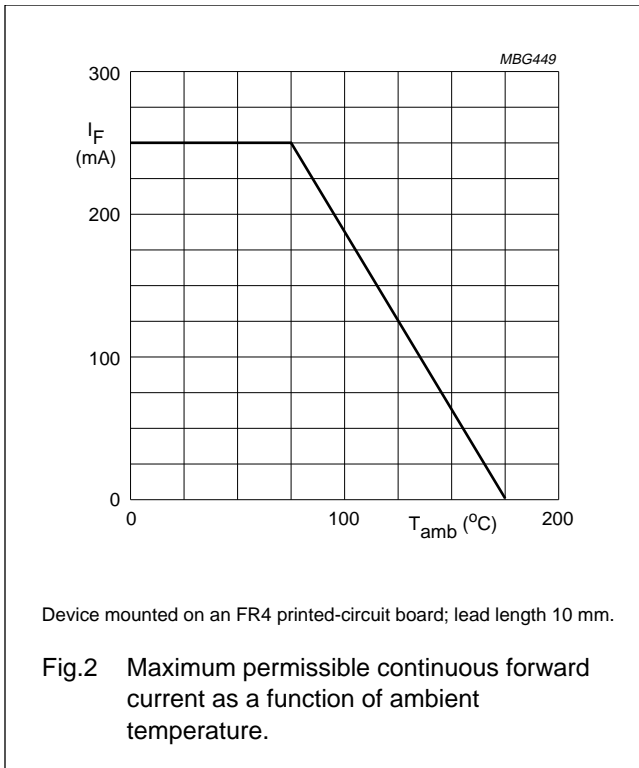

General purpose diodes

BAV18 to BAV21

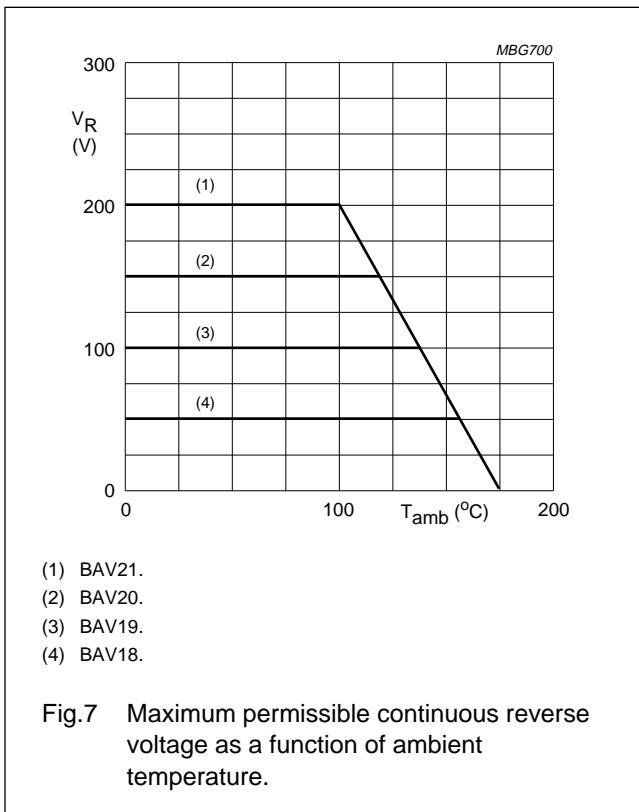
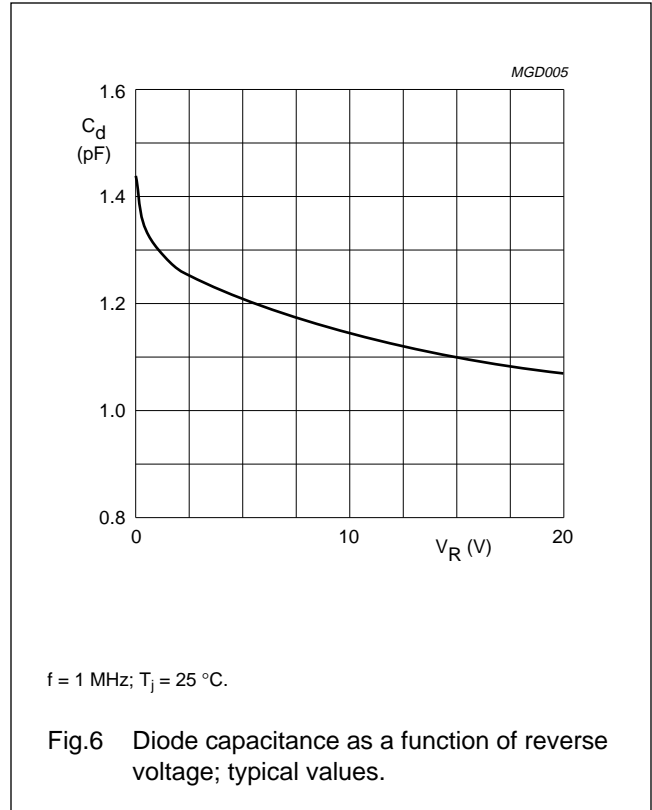
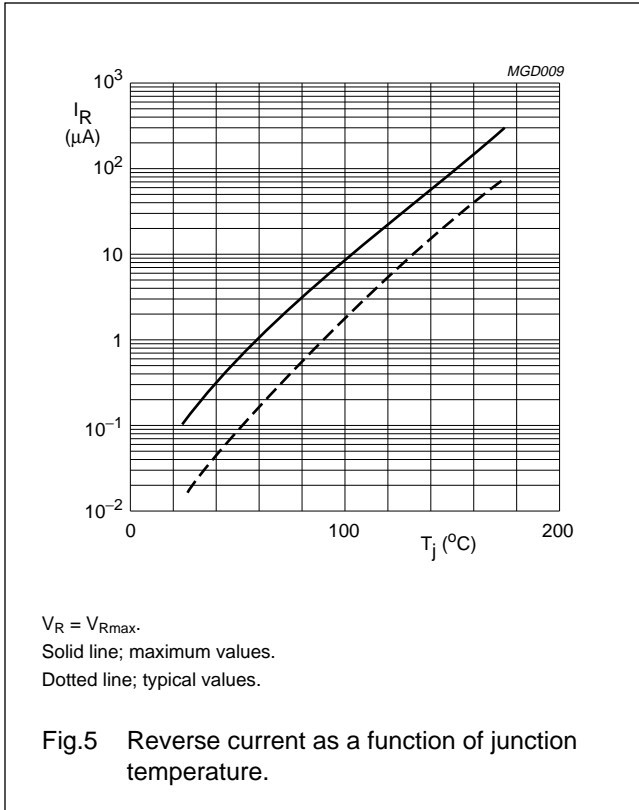

General purpose diodes

BAV18 to BAV21

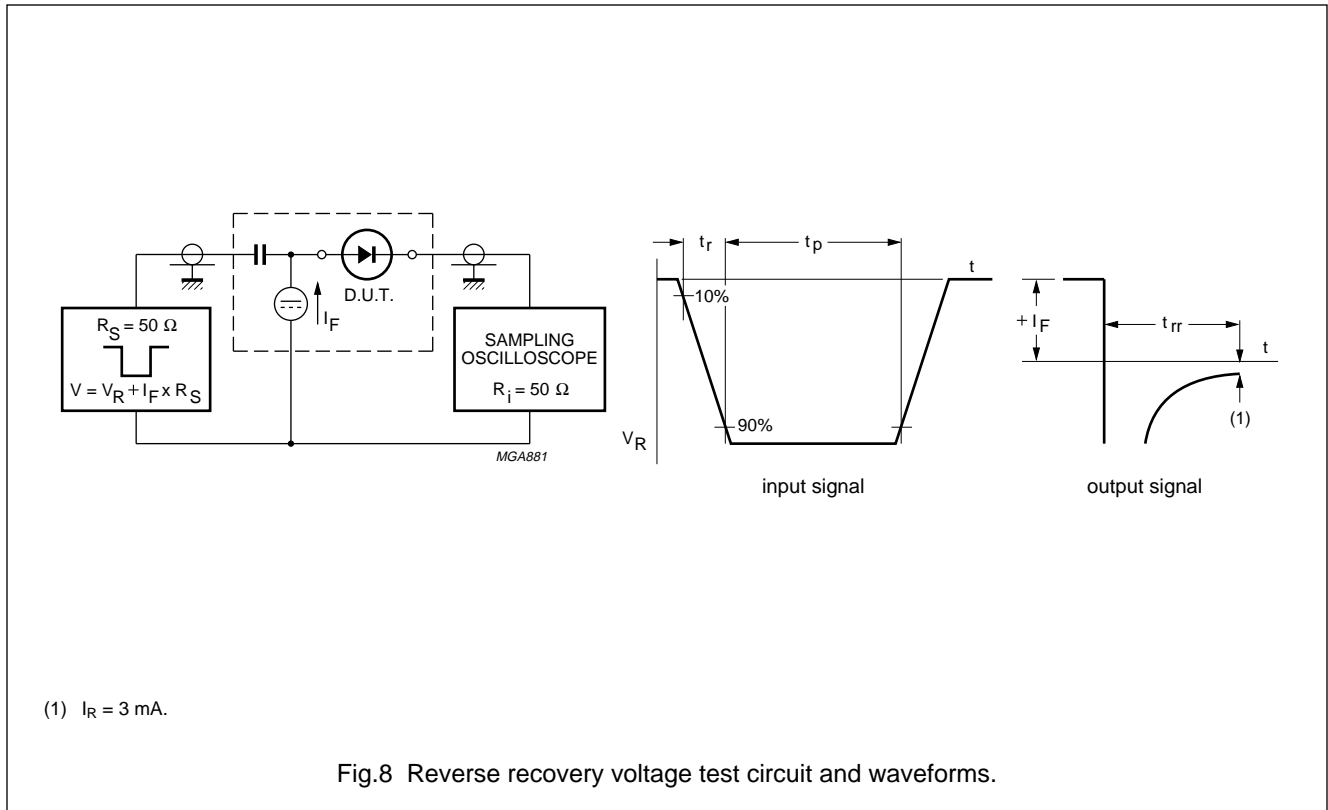

General purpose diodes

BAV18 to BAV21

PACKAGE OUTLINE

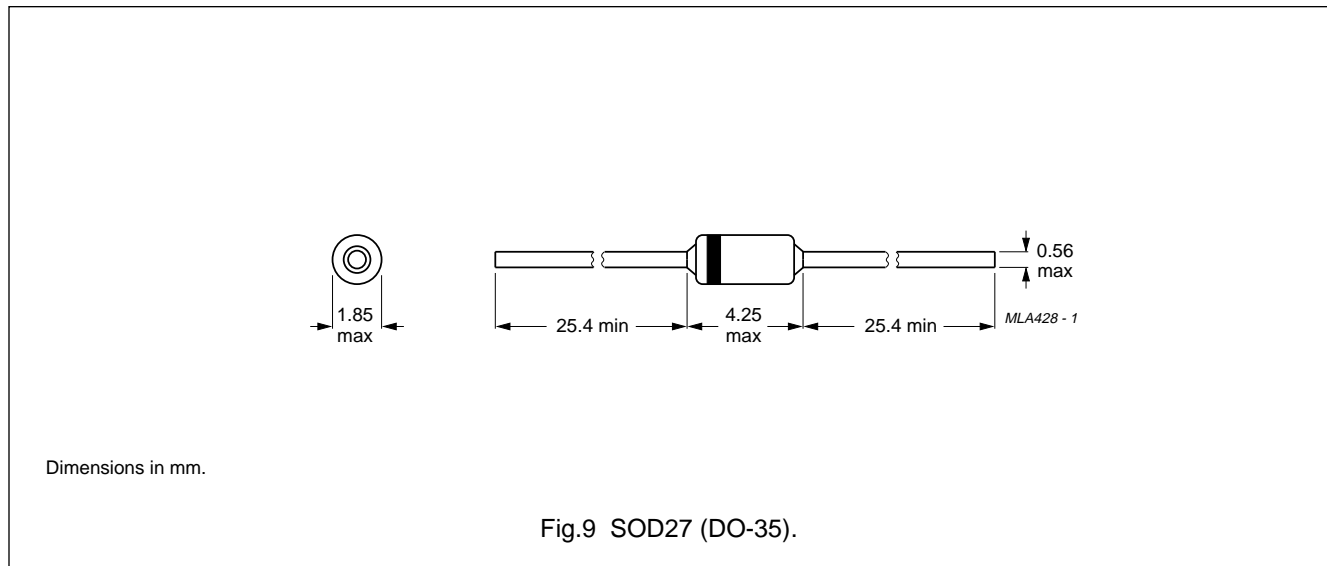

DEFINITIONS

Data Sheet Status	
Objective specification	This data sheet contains target or goal specifications for product development.
Preliminary specification	This data sheet contains preliminary data; supplementary data may be published later.
Product specification	This data sheet contains final product specifications.
Limiting values	
Limiting values given are in accordance with the Absolute Maximum Rating System (IEC 134). Stress above one or more of the limiting values may cause permanent damage to the device. These are stress ratings only and operation of the device at these or at any other conditions above those given in the Characteristics sections of the specification is not implied. Exposure to limiting values for extended periods may affect device reliability.	
Application information	
Where application information is given, it is advisory and does not form part of the specification.	

LIFE SUPPORT APPLICATIONS

These products are not designed for use in life support appliances, devices, or systems where malfunction of these products can reasonably be expected to result in personal injury. Philips customers using or selling these products for use in such applications do so at their own risk and agree to fully indemnify Philips for any damages resulting from such improper use or sale.