

R60IF3100AA6AK

aka 60IF3100AA6AK

Capacitor, film, 0.1 uF, +/-10% Tol, -55/+105C, General Purpose, 250V@85C, Lead Spacing=10 mm

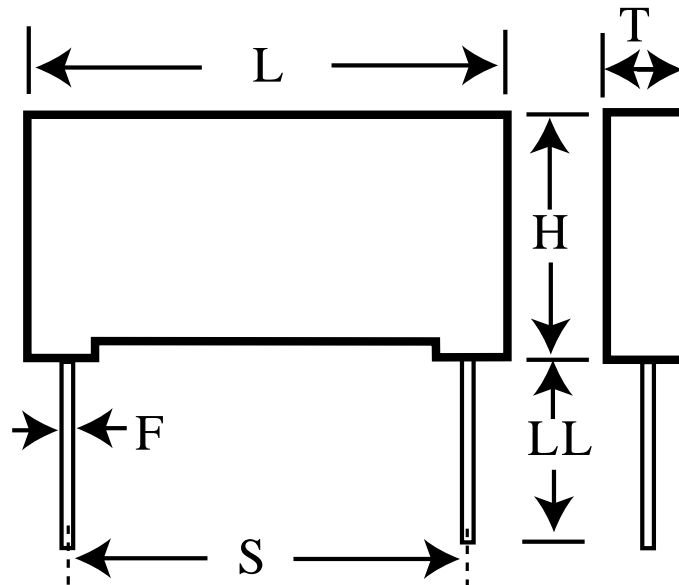

Dimensions (mm)

Specifications

ID	Dimension	Tolerance	Manufacturer:	KEMET
L	13	+0.2/-0	Brand:	Arcotronics
H	9	+1/-0	Capacitance:	0.1 uF
T	4	+0.2/-0	Temperature Range:	-55/+105C
LL	4	+2/-0	Rated Temperature:	85C
F	0.6	+/-0.05	Voltage @ rated temp:	250V
			Voltage AC:	160VAC
			Tolerance:	+/-10%
			Body Type:	Radial Box
			Construction:	Stacked
			Application:	General Purpose
			Dissipation Factor @ 1 kHz:	1%
			Dissipation Factor @ 10 kHz:	1.5%
			Insulation Resistance:	30 GOhm
			Inductance:	9 nH
			Maximum dVdT:	150v/us
			Maximum K0:	75000V^2/us
			Package Kind:	Bulk
			Package Type:	Bag
			Package Quantity:	2000