

## Series PVT312 & PbF

Microelectronic Power IC  
HEXFET® Power MOSFET Photovoltaic Relay  
Single Pole, Normally Open, 0-250V, 190mA AC/DC

### General Description

The PVT312 Photovoltaic Relay is a single-pole, normally open solid-state relay that can replace electromechanical relays in many applications. It utilizes International Rectifier's proprietary HEXFET power MOSFET as the output switch, driven by an integrated circuit photovoltaic generator of novel construction. The output switch is controlled by radiation from a GaAlAs light emitting diode (LED) which is optically isolated from the photovoltaic generator.

This SSR is specifically designed for telecom applications. PVT312L employs an active current-limiting circuitry enabling it to withstand current surge transients.

PVT312 Relays are packaged in a 6-pin, molded DIP package with either thru-hole or surface mount ("gull-wing") terminals. It is available in standard plastic shipping tubes or on tape-and-reel. Please refer to the Part Identification information opposite.

### Features

- HEXFET Power MOSFET output
- Bounce-free operation
- 4,000 V<sub>RMS</sub> I/O isolation
- Load current limiting
- Linear AC/DC operation
- Solid-State Reliability
- UL recognized and BABT certified; pending for lead-free devices (PbF)
- ESD Tolerance:
  - 4000V Human Body Model
  - 500V Machine Model

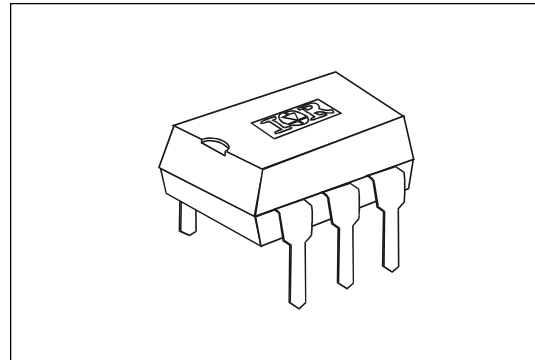

### Applications

- On/Off Hook switch
- Dial-Out relay
- Ring injection relay
- Ground start
- General switching

### Part Identification

PVT312L & PbF	current limit, thru-hole
PVT312LS & PbF	current limit, surface-mount
PVT312LS-T & PbF	current limit, surface-mount, tape and reel
PVT312 & PbF	no current limit, thru-hole
PVT312S & PbF	no current limit, surface-mount
PVT312S-T & PbF	no current limit, surface-mount, tape and reel

*(HEXFET is the registered trademark for International Rectifier Power MOSFETs)*

**Electrical Specifications** ( $-40^{\circ}\text{C} \leq T_A \leq +85^{\circ}\text{C}$  unless otherwise specified)

<b>INPUT CHARACTERISTICS</b>	<b>Part Numbers</b>		<b>Units</b>
	PVT312L	PVT312	
Minimum Control Current (see figures 1 and 2)	2.0		mA
Maximum Control Current for Off-State Resistance @ $T_A=+25^{\circ}\text{C}$	0.4		mA
Control Current Range (Caution: current limit input LED, see figure 6)	2.0 to 25		mA
Maximum Reverse Voltage	6.0		V

<b>OUTPUT CHARACTERISTICS</b>	PVT312L	PVT312	
Operating Voltage Range	0 to $\pm 250$		$V_{\text{DC or AC peak}}$
Maximum Load Current @ $T_A=+40^{\circ}\text{C}$ , 5mA Control (see figures 1 and 2)			
A Connection	170	190	mA (AC or DC)
B Connection	190	210	mA (DC)
C Connection	300	320	mA (DC)
Maximum On-State Resistance @ $T_A=+25^{\circ}\text{C}$ for 50mA pulsed load 5mA Control (see figure 4)			
A Connection	15	10	$\Omega$
B Connection	8	5.5	$\Omega$
C Connection	4.25	3	$\Omega$
Maximum Off-State Leakage @ $T_A=+25^{\circ}\text{C}$ , $\pm 250\text{V}$ (see figure 5)	1.0		$\mu\text{A}$
Current Limit @ $T_A=+25^{\circ}\text{C}$ , 5mA Control			
Connection:	A	C	
Minimum	190	330	n/a
Maximum	300	560	n/a
Maximum Turn-On Time @ $T_A=+25^{\circ}\text{C}$ (see figure 7) for 50mA, 100 $V_{\text{DC}}$ load, 5mA Control	3.0		ms
Maximum Turn-Off Time @ $T_A=+25^{\circ}\text{C}$ (See Fig. 6) For 50mA, 100 $V_{\text{DC}}$ load, 5mA Control	0.5		ms
Maximum Output Capacitance @ 50V <sub>DC</sub>	50		pF

<b>GENERAL CHARACTERISTICS</b>	<b>ALL MODELS</b>		
Minimum Dielectric Strength, Input-Output	4000		$V_{\text{RMS}}$
Minimum Insulation Resistance, Input-Output @ $T_A=+25^{\circ}\text{C}$ , 50%RH, 100V <sub>DC</sub>	$10^{12}$		$\Omega$
Maximum Capacitance, Input-Output	1.0		pF
Maximum Pin Soldering Temperature (10 seconds maximum)	+260		$^{\circ}\text{C}$
Ambient Temperature Range:	Operating	-40 to +85	$^{\circ}\text{C}$
	Storage	-40 to +100	

International Rectifier does not recommend the use of this product in aerospace, avionics, military or life support applications. Users of this International Rectifier product in such applications assume all risks of such use and indemnify International Rectifier against all damages resulting from such use.

Connection Diagrams

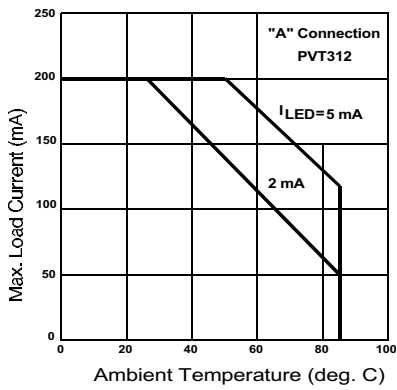
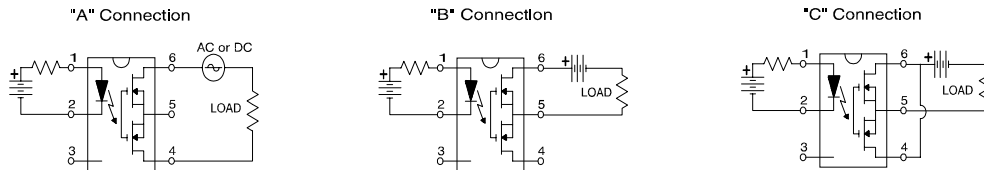

Figure 1. Typical Current Derating Curves

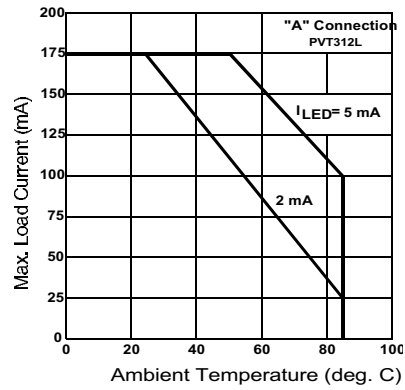

Figure 2. Typical Current Derating Curves

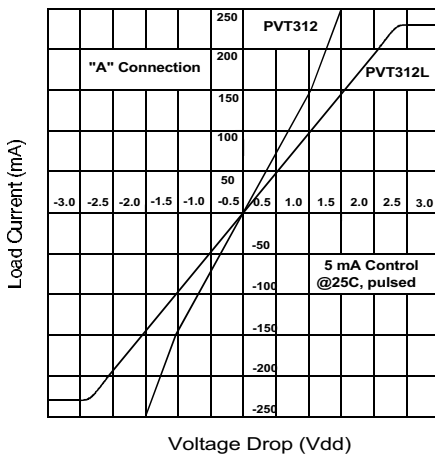

Figure 3. Linearity Characteristics

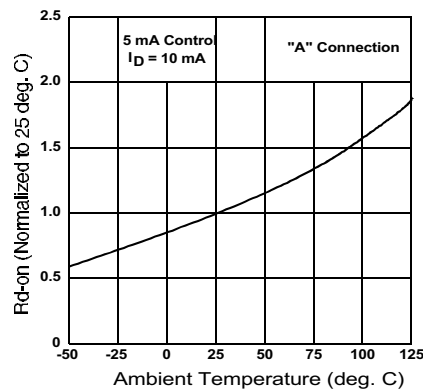

Figure 4. Typical Normalized On-Resistance

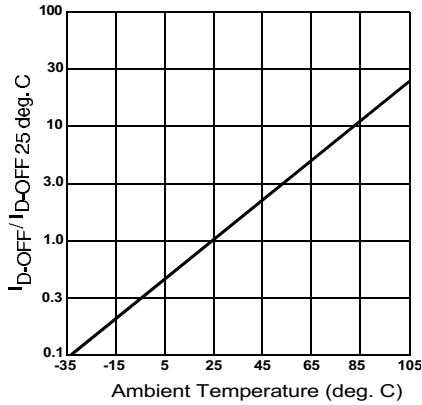

Figure 5. Typical Normalized Off-State Leakage

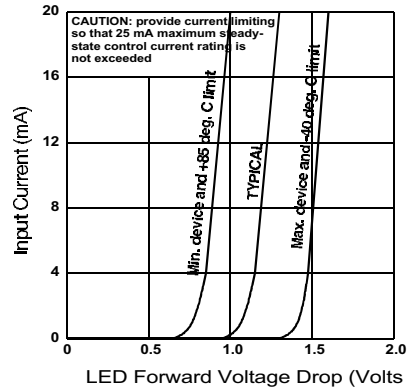

Figure 6. Input Characteristics (Current Controlled)

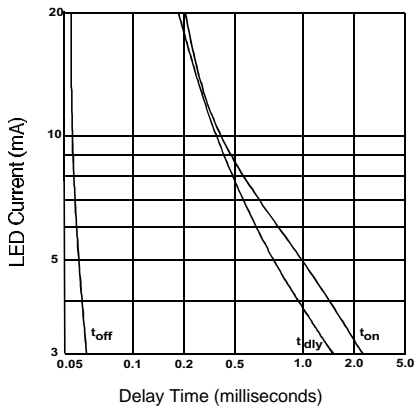

Figure 7. Typical Delay Times

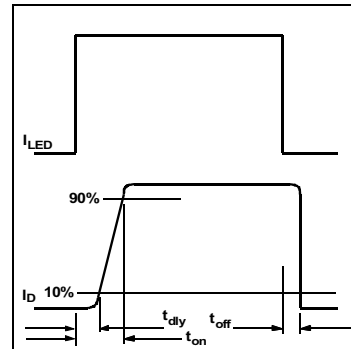

Figure 8. Delay Time Definitions

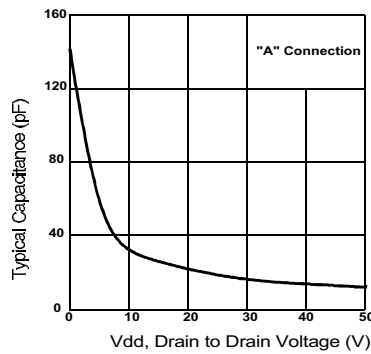

Figure 9. Typical Output Capacitance

**Case Outlines**

