



# STPS12045TV

## POWER SCHOTTKY RECTIFIER

### MAIN PRODUCT CHARACTERISTICS

<b>I<sub>F(AV)</sub></b>	<b>2 x 60 A</b>
<b>V<sub>RRM</sub></b>	<b>45 V</b>
<b>T<sub>j</sub> (max)</b>	<b>150 °C</b>
<b>V<sub>F</sub> (max)</b>	<b>0.67 V</b>

### FEATURES AND BENEFITS

- VERY SMALL CONDUCTION LOSSES
- NEGLIGIBLE SWITCHING LOSSES
- EXTREMELY FAST SWITCHING
- LOW THERMAL RESISTANCE
- INSULATED PACKAGE:  
Insulating voltage = 2500 V<sub>(RMS)</sub>  
Capacitance = 45 pF

### DESCRIPTION

Dual power Schottky rectifier suited for Switched Mode Power Supplies and high frequency DC to DC converters.

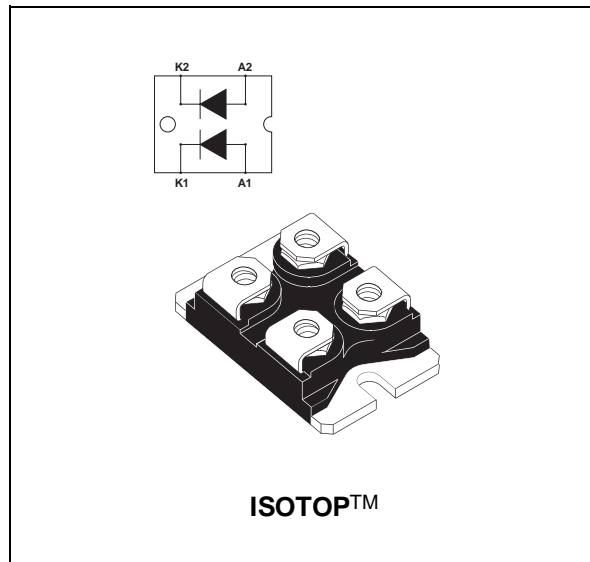
Packaged in ISOTOP, this device is especially intended for use in low voltage, high frequency inverters, free wheeling and polarity protection applications.

### ABSOLUTE RATINGS (limiting values) per diode

Symbol	Parameter		Value	Unit	
V <sub>RRM</sub>	Repetitive peak reverse voltage		45	V	
I <sub>F(RMS)</sub>	RMS forward current		125	A	
I <sub>F(AV)</sub>	Average forward current	T <sub>c</sub> = 95°C	Per diode	60	A
		δ = 0.5	Per device	120	
I <sub>FSM</sub>	Surge non repetitive forward current	tp = 10 ms Sinusoidal	900	A	
I <sub>RRM</sub>	Repetitive peak reverse current	tp = 2 μs square F = 1kHz	2	A	
I <sub>RSM</sub>	Non repetitive peak reverse current	tp = 100μs square	5	A	
T <sub>stg</sub>	Storage temperature range		- 55 to + 150	°C	
T <sub>j</sub>	Maximum operating junction temperature *		150	°C	
dV/dt	Critical rate of rise of reverse voltage		10000	V/μs	

\* :  $\frac{dP_{tot}}{dT_j} < \frac{1}{R_{th(j-a)}}$  thermal runaway condition for a diode on its own heatsink

ISOTOP is a registered trademark of STMicroelectronics



# STPS12045TV

## THERMAL RESISTANCES

Symbol	Parameter		Value	Unit
$R_{th(j-c)}$	Junction to case	Per diode	1	$^{\circ}\text{C}/\text{W}$
		Total	0.55	
$R_{th(c)}$		Coupling	0.1	

When the diodes 1 and 2 are used simultaneously :

$$\Delta T_j(\text{diode } 1) = P(\text{diode } 1) \times R_{th}(\text{Per diode}) + P(\text{diode } 2) \times R_{th(c)}$$

## STATIC ELECTRICAL CHARACTERISTICS (per diode)

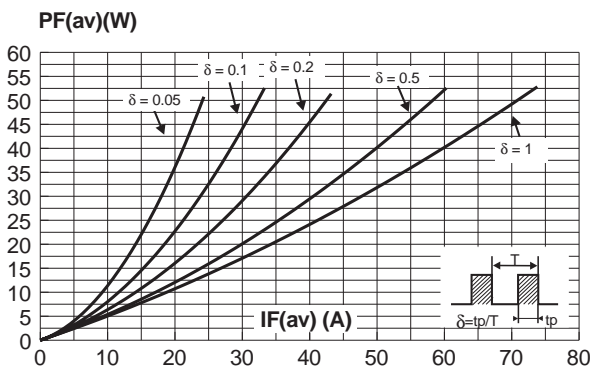
Symbol	Parameter	Tests Conditions		Min.	Typ.	Max.	Unit
$I_R^*$	Reverse leakage current	$T_j = 25^{\circ}\text{C}$	$V_R = V_{RRM}$			1	mA
		$T_j = 125^{\circ}\text{C}$		43	150		
$V_F^*$	Forward voltage drop	$T_j = 25^{\circ}\text{C}$	$I_F = 120 \text{ A}$			0.91	V
		$T_j = 125^{\circ}\text{C}$	$I_F = 120 \text{ A}$		0.72	0.87	
		$T_j = 125^{\circ}\text{C}$	$I_F = 60 \text{ A}$		0.52	0.67	

Pulse test : \*  $t_p = 380 \mu\text{s}$ ,  $\delta < 2\%$

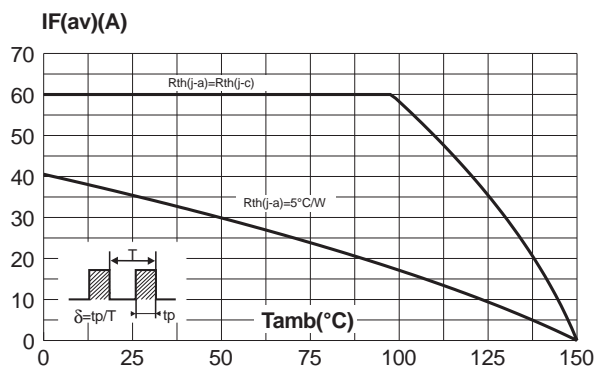
To evaluate the conduction losses use the following equation :

$$P = 0.47 \times I_{F(AV)} + 0.00333 \times I_{F(RMS)}^2$$

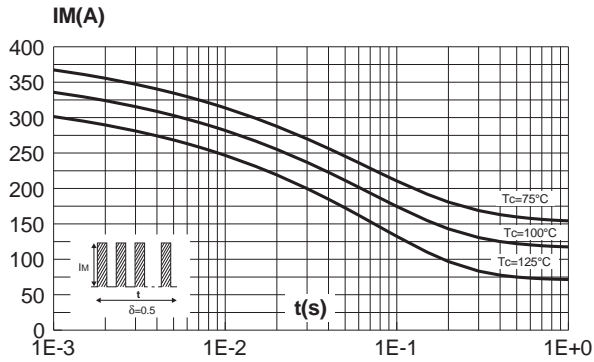
**Fig. 1:** Average forward power dissipation versus average forward current (per diode).



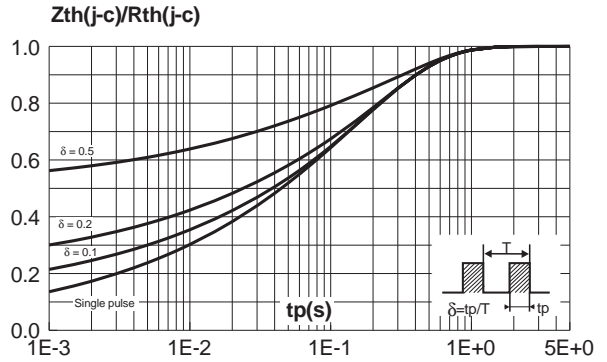
**Fig. 2:** Average current versus case temperature ( $\delta = 0.5$ ) (per diode).



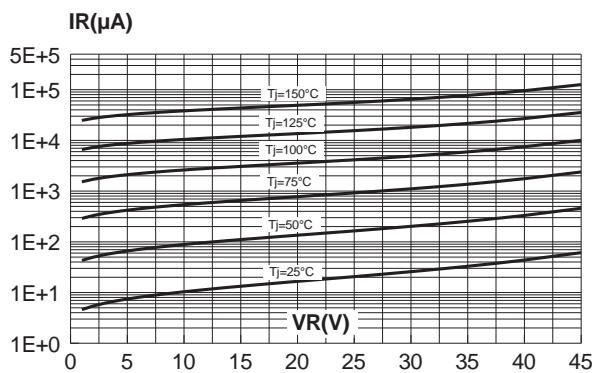
**Fig. 3:** Non repetitive surge peak forward current versus overload duration (maximum values, per diode).



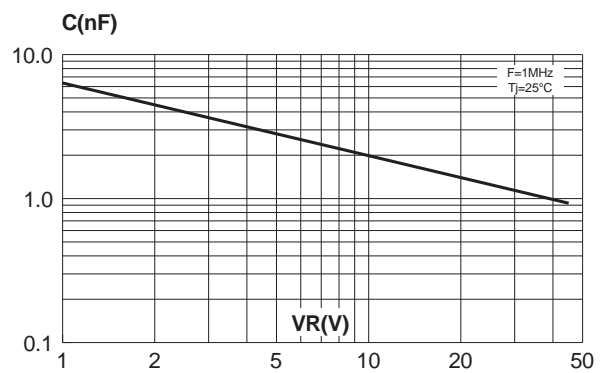
**Fig.4 :** Relative variation of thermal transient impedance junction to case versus pulse duration.



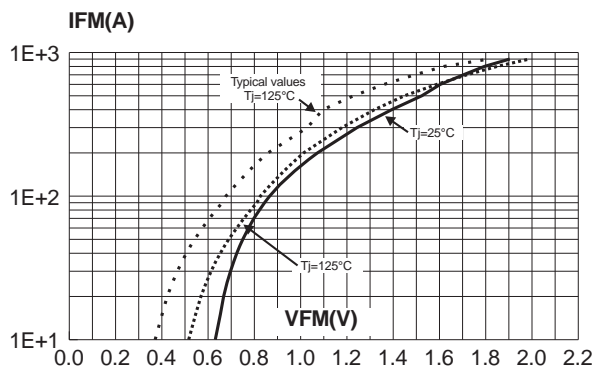
**Fig. 5:** Reverse leakage current versus reverse voltage applied (typical values, per diode).



**Fig. 6:** Junction capacitance versus reverse voltage applied (typical values, per diode).

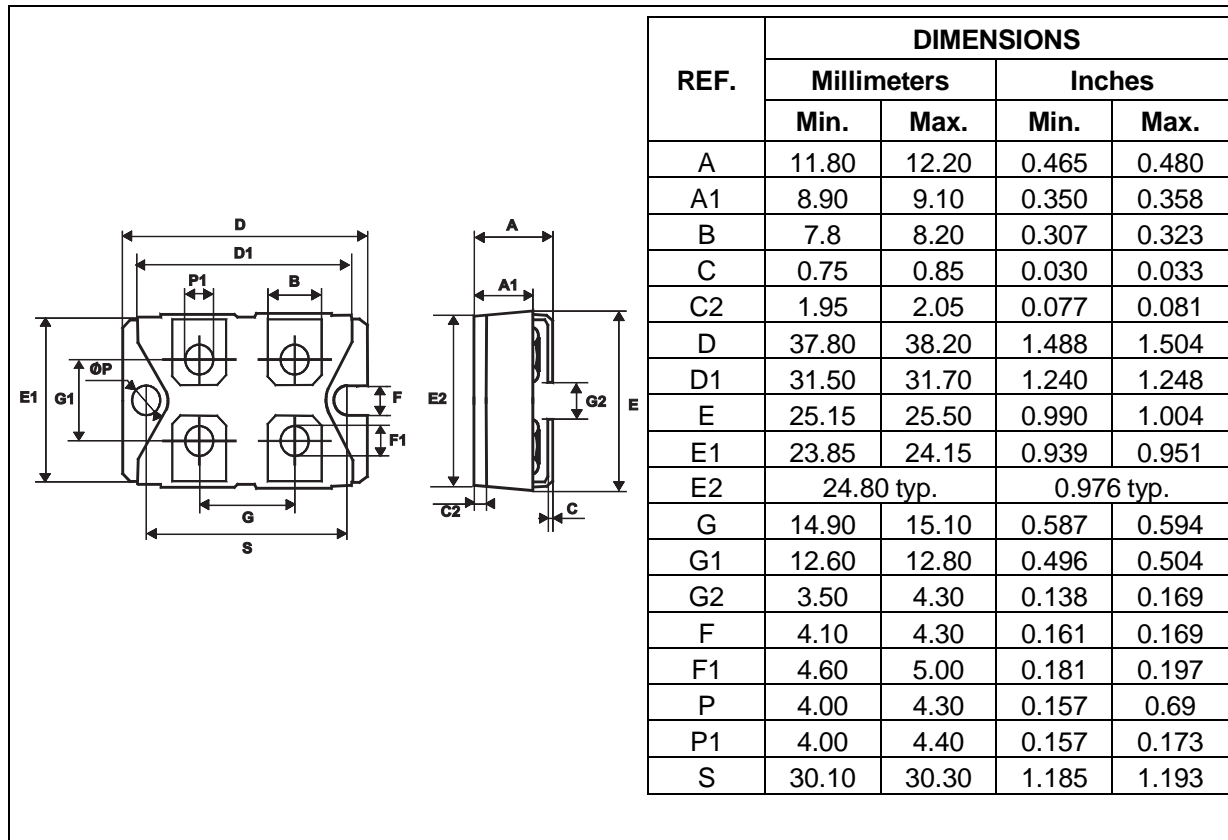


**Fig. 7:** Forward voltage drop versus forward current (maximum values, per diode).



# STPS12045TV

## PACKAGE MECHANICAL DATA ISOTOP



Type	Marking	Package	Weight	Base qty	Delivery mode
STPS12045TV	STPS12045TV	ISOTOP	28.9 without screws	10	Tube

- Cooling method: by conduction (C)
- Recommended torque value: 1.3 N.m.
- Maximum torque value: 1.5 N.m.
- Epoxy meets UL94,V0

Information furnished is believed to be accurate and reliable. However, STMicroelectronics assumes no responsibility for the consequences of use of such information nor for any infringement of patents or other rights of third parties which may result from its use. No license is granted by implication or otherwise under any patent or patent rights of STMicroelectronics. Specifications mentioned in this publication are subject to change without notice. This publication supersedes and replaces all information previously supplied. STMicroelectronics products are not authorized for use as critical components in life support devices or systems without express written approval of STMicroelectronics.

The ST logo is a registered trademark of STMicroelectronics

© 1999 STMicroelectronics - Printed in Italy - All rights reserved.

STMicroelectronics GROUP OF COMPANIES

Australia - Brazil - China - Finland - France - Germany - Hong Kong - India - Italy - Japan - Malaysia  
Malta - Morocco - Singapore - Spain - Sweden - Switzerland - United Kingdom - U.S.A.

<http://www.st.com>