



Description

PLEDxSW Series open LED protectors provide a switching electronic shunt path when an LED in an LED string fails as an open circuit. This ensures that the remaining string of LEDs will continue to function if a single LED does not.

PLEDxSW Series devices were designed to enable higher reliability in indoor LED lighting applications such as advertisement lighting and other applications. Additionally, they are molded from white material to make them less visible in the LED fixture and the white molding also reflects more light to improve overall light engine efficiency.

Compatible with one, two and three watt LEDs that have a nominal 3V forward characteristic, PLEDxSW Series devices are available in SMB surface mount package. The DO-214AA (SMB) low profile package is ideal for dense board applications.

Agency Approvals

Agency	Agency File Number
	E133083

Schematic Symbol

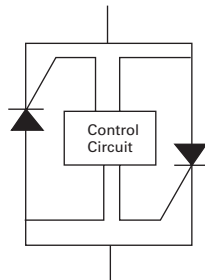

Features & Benefits

- Fast switching
- Automatically resets after power cycle
- Low profile, small foot print standard DO-214AA package
- Compatible with industrial lighting environments
- Compatible with PWM frequencies up to 30 kHz
- RoHS compliant and halogen-free

Electrical Characteristics (All parameters are measured at T=25°C unless otherwise noted)

Part Number	Marking	V_{BR} breakdown		V_{DRM} breakdown	I_H	I_S	$I_T @ V_T$	$V_T @ I_T = 1$ Amp	Critical rate of rise dV/dt
		Volts		Volts	mAmps	mAmps	Amps	Volts	Volts
		Min	Max	Min	Min	Max	Max	Max	Max
PLED6SW	PL6	6	16	6	5	100	1.0	1.2	250V/ μ s
PLED9SW	PL9	9	18	9					
PLED13SW	PL13	13	26	13					
PLED18SW	PL18	18	33	18					

Thermal Considerations

Package	Symbol	Parameter	Value	Unit
DO-214AA in White 	T_J	Operating Junction Temperature Range	-40 to +150	°C
	T_S	Storage Temperature Range	-65 to +150	°C
	$R_{\theta JA}$	Thermal Resistance: Junction to Ambient	DO-214AA: 90 ¹ DO-214AA: 40 ²	°C/W

Notes:

- Standard FR-4 PCB with Copper Pads (Recommended Size)
- Aluminum PCB
 - Thickness: 1.6mm
 - Grade: 1-2 W/mK Thermal Conductivity
 - Trace thickness: 2 oz
 - Insulation layer thickness: 215 um
 - Solder Pad Dimensions: 2.0mm x 2.8mm (Recommended Size)

V-I Characteristics

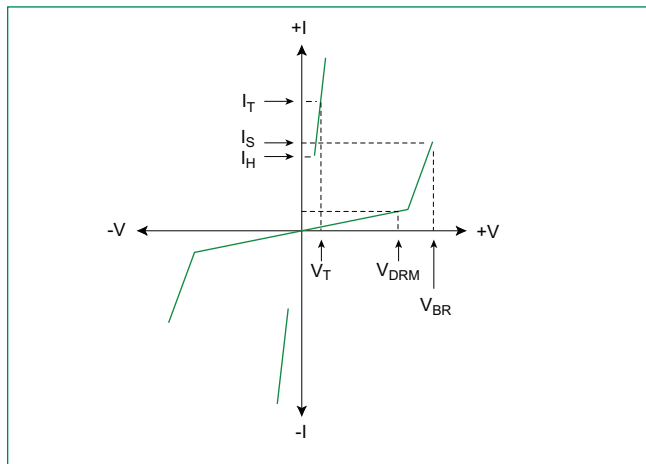

V_{BR} vs. Junction Temperature

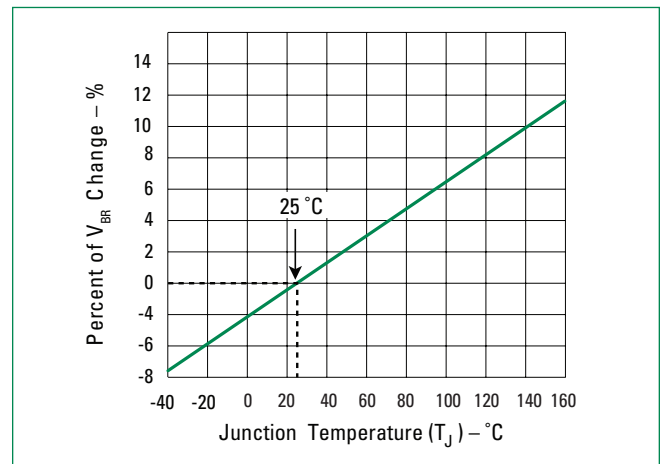

Normalized DC Holding Current vs. Case Temperature

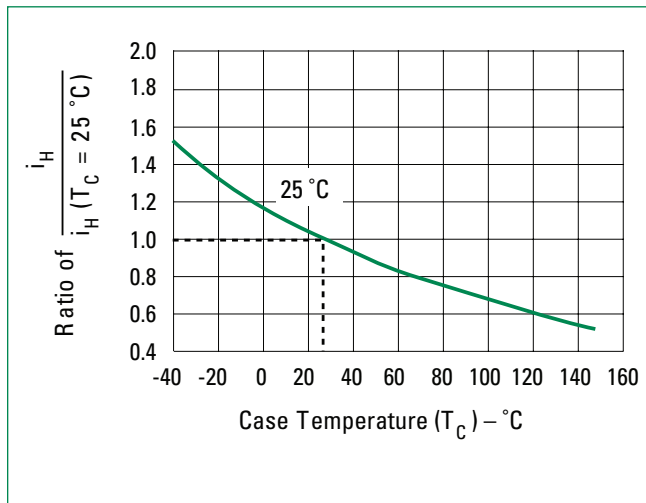

LED Interference Test Circuit

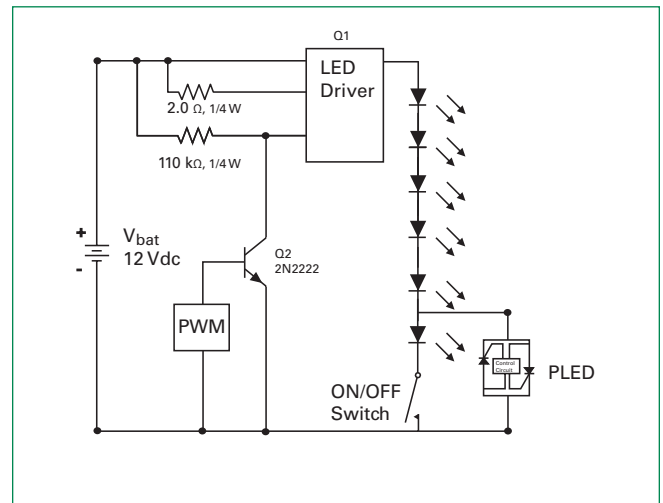

6 LEDs in Series 50% Duty Cycle 10kHz

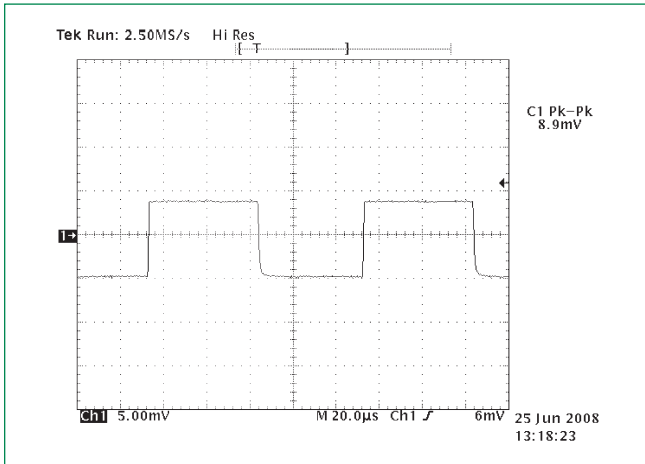

5 LEDs and 1 PLED in Series 50% Duty Cycle 10kHz

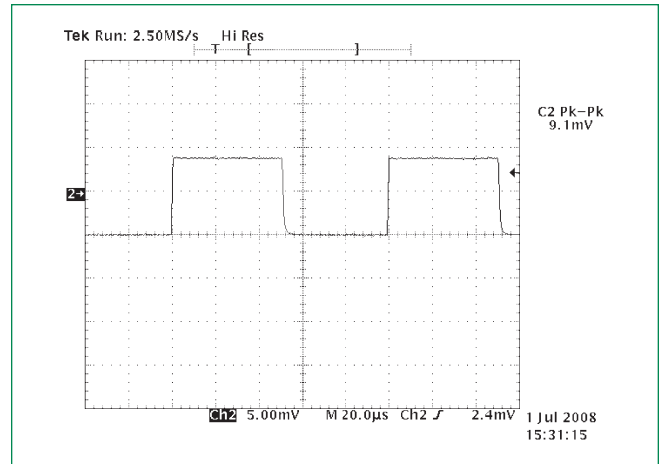

Note: These two graphs show the current magnitude through the LED string with and without the PLED included. There is no noticeable effect on the LED current magnitude when the PLED is included in the circuit as compared to the LED current magnitude when the PLED is not in the circuit. (The conversion factor for the test measurement in the graphs above is 10mA/mV for the Pearson coil measurement, therefore, the current magnitude in the first figure is 10mA*8.9 = 89mA, while the second figure is 91mA.)

PLED in the Off-State 10kHz

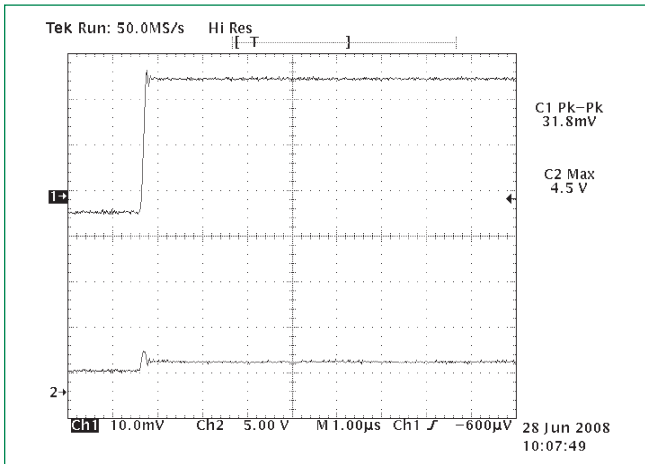

Channel 1: current through LEDs (318 mA)
 Channel 2: voltage across PLED device (4.5 V)

PLED device zeners and then turns fully on 10kHz

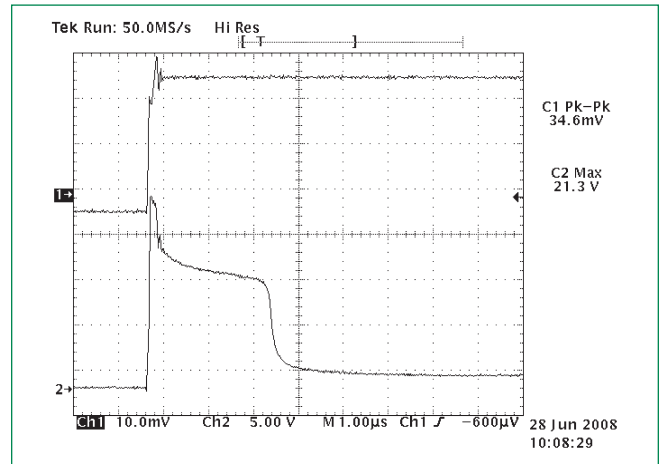

Channel 1: current through LEDs (346 mA) and PLED device once it is fully turned on 2.5 µsec later
 Channel 2: voltage across PLED device (21.3 V before PLED crowbars with 2 V drop)

Soldering Parameters

Reflow Condition	Pb – Free assembly	
Pre Heat	- Temperature Min ($T_{s(min)}$)	150°C
	- Temperature Max ($T_{s(max)}$)	200°C
	- Time (min to max) (t_s)	60 – 180 secs
Average ramp up rate (Liquidus Temp (T_L) to peak)	3°C/second max	
$T_{s(max)}$ to T_L - Ramp-up Rate	3°C/second max	
Reflow	- Temperature (T_L) (Liquidus)	217°C
	- Temperature (t_L)	60 – 150 seconds
Peak Temperature (T_p)	260 ^{+0/-5} °C	
Time within 5°C of actual peak Temperature (t_p)	30 seconds	
Ramp-down Rate	6°C/second max	
Time 25°C to peak Temperature (T_p)	8 minutes max	
Do not exceed	260°C	

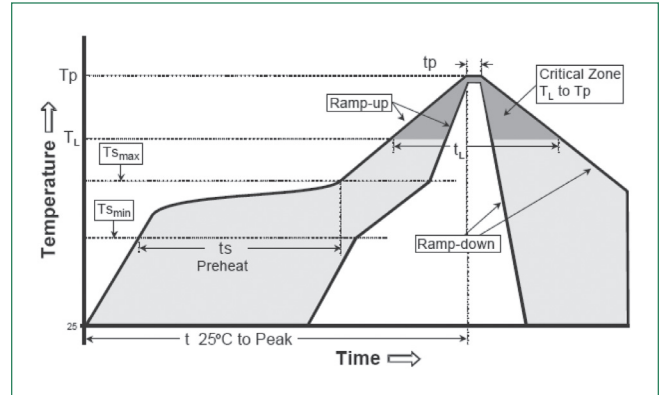

Physical Specifications

Terminal Material	Copper Alloy
Terminal Finish	100% Matte Tin Plated
Body Material	UL recognized epoxy meeting flammability classification 94V-0

Environmental Specifications

High Temperature Voltage Blocking	MIL-STD-750: Method 1040, Condition A 80% min V_{DRM} (VAC-peak), 150°C, 504 hours
Temperature Cycling	MIL-STD-750: Method 1051 -65°C to 150°C, 15-minute dwell, 100 cycles
Biased Temperature & Humidity	EIA/JEDEC: JESD22-A101 80% V_{DRM} , 85°C, 85%RH, 1008 hours
High Temperature Storage	MIL-STD-750: Method 1031 150°C, 1008 hours
Low Temperature Storage	-65°C, 1008 hours
Thermal Shock	MIL-STD-750: Method 1056 0°C to 100°C, 5-minute dwell, 10-second transfer, 10 cycles
Resistance to Solder Heat	MIL-STD-750: Method 2031 260°C, 10 seconds

Part Numbering System

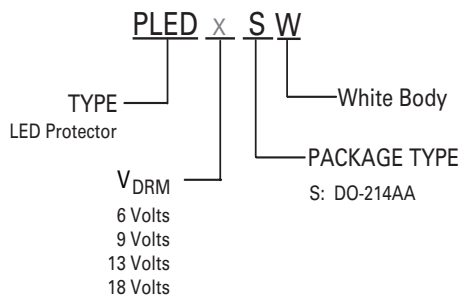

Part Marking System

DO-214AA

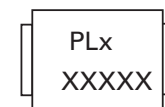

Packaging

Package	Description	Packaging Quantity	Industry Standard
S	DO-214AA	2500	EIA-481-1

Dimensions - DO-214 AA Package

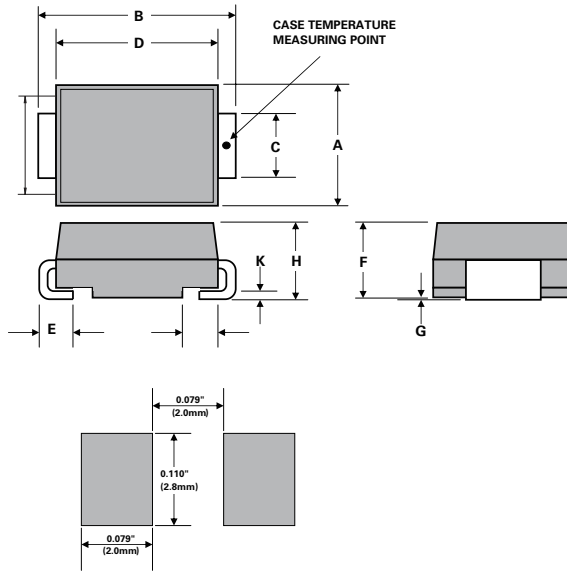

Recommended solder pad layout
(Reference Only)

Dimensions	Inches		Millimeters	
	Min	Max	Min	Max
A	0.130	0.156	3.30	3.95
B	0.201	0.220	5.10	5.60
C	0.077	0.087	1.95	2.20
D	0.159	0.181	4.05	4.60
E	0.030	0.063	0.75	1.60
F	0.075	0.096	1.90	2.45
G	0.002	0.008	0.05	0.20
H	0.077	0.104	1.95	2.65
K	0.006	0.016	0.15	0.41

DO-214AA Embossed Carrier Reel Pack (RP)

Meets all EIA-481-1 Standards

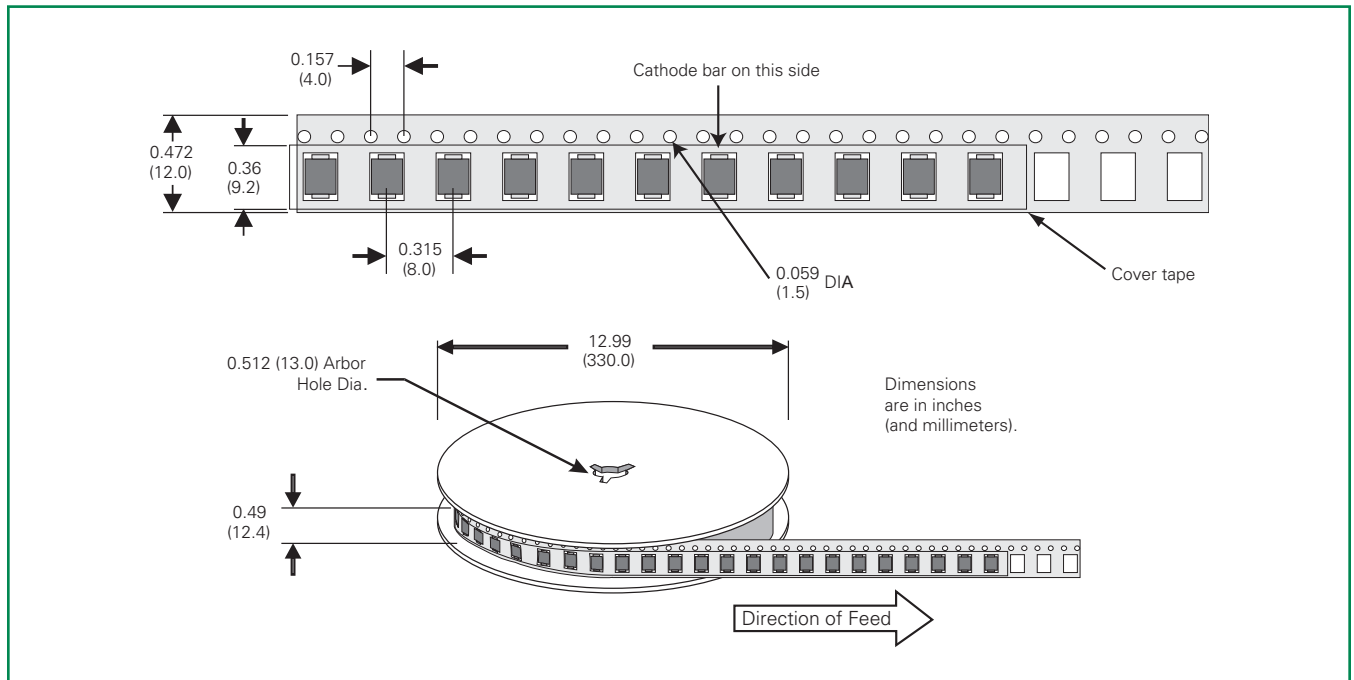

Dimensions are in inches (and millimeters).