

DATA SHEET

Part Number : PKGS-00GXP1-R

1. Scope

This data sheet is applied to surface mountable acceleration sensor.

2. Part Number

Murata Part Number : PKGS-00GXP1-R

3. Dimensions

- 3-1 Appearance : As per paragraph 10.Appearance criteria.
 3-2 Dimensions : See Figure 2.
 3-3 Construction : A piezo ceramic element is stuck between two ceramic substrate.

4. Characteristics

(* Temperature 25±3°C, unless otherwise noted.)

	Parameter	Test Conditions	Min.	Typ.	Max.	Units	Note
4-1	Charge Sensitivity	1kHz, 98.1m/s ² (10G) applied in the direction of D axis at Fig.1	-15%	35.7 (0.350)	+15%	fC/(m/s ²) (pC/G)	1, 2, 4
4-2	Insulation Resistance : Ri	10V DC, after 1 min.	500	10000		MΩ	
4-3	Non-Linearity	% of the Full-Scale output at 490m/s ² (50G). Range : ±50G		1%	5%		
4-4	Resonance Frequency		26	31	36	kHz	3
4-5	Inclined Angle of Sensitivity Axis		-3	0	3	Degree	
4-6	Temperature Drift of Charge Sensitivity	Maximum deviation from initial value at +25°C.	70°C	-0.5%	3.0%	6.5%	
			0°C	-4.0%	-2.0%	0.5%	
4-7	Capacitance : Co	1Vrms, 1kHz	-30%	390	+30%	pF	

Note:

- As measured with an applied acceleration in the direction of D at figure 1. In this case, positive voltage and electrical charge are generated at electrode B.
- 1G = 9.80665m/s²
- Resonance frequency of inner bimorph element.
- f = 10⁻¹⁵

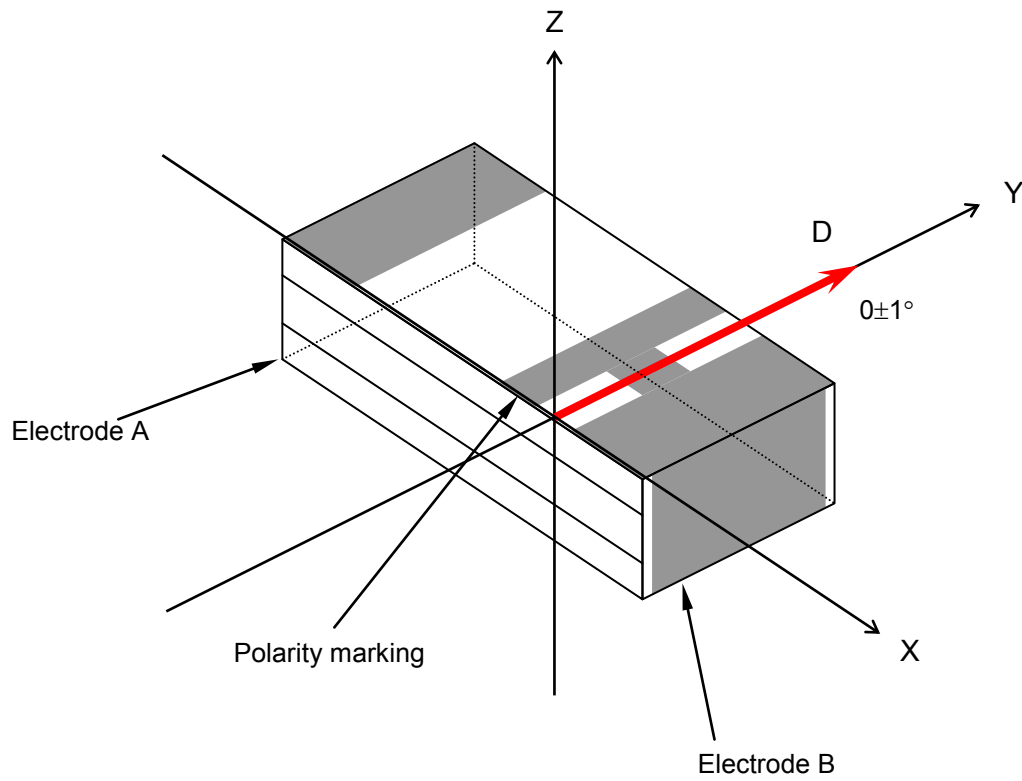
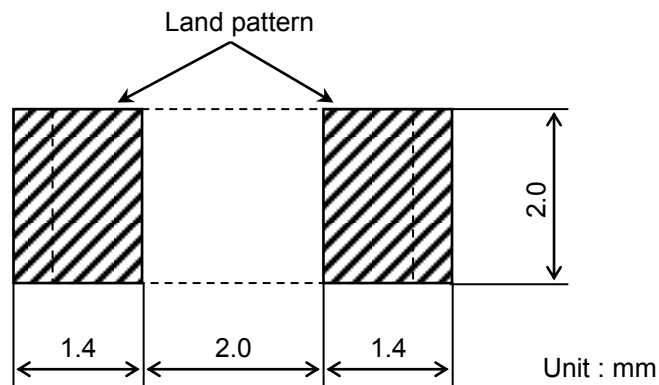

Figure 1.

Axis D : This axis is an acceleration applied direction, when electric charge sensitivity is checked.

5. Standard land pattern



6. Absolute Rating

Apply voltage between electrode A and B : 10 Vp-p within 60 sec. max.
 Storage temperature range : -40 to 85 °C
 Operating temperature range : -40 to 85 °C

7. Physical Characteristics

	Test Item	Condition of Test	Performance Requirements
7-1	Mechanical Shock	The transducer shall be measured after being applied three impacts in plus and minus directions of three mutually perpendicular planes. The shock is specified as $29400\text{m/s}^2(3000\text{G})$ half sine pulse of 0.3 ms duration.	No visible damage and the measured values shall meet Table 2
7-2	Vibration	The transducer shall be measured after being applied vibration of amplitude of 1.5 mm with 10 to 55 Hz band of vibration frequency to each of 3 perpendicular directions for 2 hours. (5 minutes \times 24 cycles)	
7-3	Bend Strength PCB	The transducer is soldered onto the center of PCB (1.6 mm thickness) which is laid on the 2 small supporters spaced 90 mm. PCB is deflected to 1 mm below from horizontal level by the pressing force with 20×10 . R10 stick. The force is supplied for 1 second, 5 times repeatably. 	No visible damage and the measured values shall meet Table 3
7-4	Resistance to Reflow Soldering	The transducer shall be mounted on PCB, then measured after being applied following reflow conditions. <Test flow> Pre-heating : 60 to 150 sec. at 150 to 180 °C Heating : Within 60 sec. at 200 °C (or more) Within 30 sec. at 250 °C (or more) Peak Temperature: Within 10 sec. at 260 °C Shock sensor should be tested 2 times of this test flow. PCB size : 115 \times 80 \times 0.8 mm After being placed at ambient conditions for 8 hours, the transducer shall be measured.	No visible damage and the measured values shall meet Table 2
7-5	Solderability	End terminals are immersed in rosin for 5 seconds then immersed in soldering bath of $+245\pm 5^\circ\text{C}$ for 3 ± 0.5 seconds.	75% min. end terminals shall be wet with solder.
7-6	Washability	See Table 1	No visible damage and the measured values shall meet Table 2

Table 1. Wash

Cleaning Solvent		Alcohol (Iso-propanol)	Water (Tap water, Demineralized water)	Cleaning Water Solution (Cleanthrough 750H, Pine alpha 100S)	Silicon (Techno care FRW)
Item					
Temperature Difference: ΔT *1 [ΔT = Component - Solvent]		$\Delta T < 100^{\circ}\text{C}$			
Condition					
(1)	Ultrasonic Wash	1 minute max. in above solvent at 60°C max. (Frequency : 28 kHz, Output : 20 W/L)			
(2)	Immersion Wash	5 minutes max. in above solvent at 60°C max.			
(3)	Shower or Rinse Wash	5 minutes max. in above solvent at 60°C max.			
(4)	Drying	1 to 5 minutes. by air blow at 80°C max.			

*1 ex. In case the component at 90°C immerses into cleaning solvent at 60°C ,
then $\Delta T = 30^{\circ}\text{C}$.

Note(Wash)

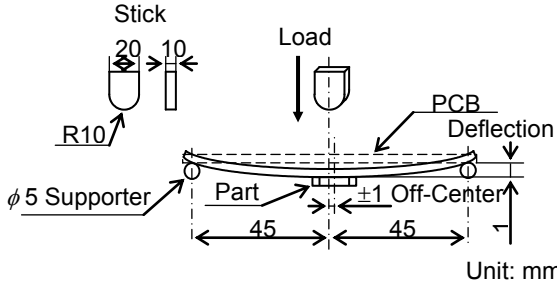
1. Please insure the component is thoroughly evaluated in your application circuit.
2. The component may be damaged if it is washed with alkali cleaning solvent.
3. Flux should be washed out before use.

8. Environmental Characteristics

	Test Item	Condition of Test	Performance Requirements
8-1	High Temperature	After being placed in a thermal chamber with at $+85\pm 2^{\circ}\text{C}$ for 1000 hours and then being placed at ambient conditions for 8 hours, the transducer shall be measured.	The measured values shall meet Table 2
8-2	Low Temperature	After being placed in a thermal chamber with at $-40\pm 2^{\circ}\text{C}$ for 1000 hours and then being placed at ambient conditions for 8 hours, the transducer shall be measured.	The measured values shall meet Table 2
8-3	Humidity	After being placed in a humidity chamber with 90 to 95% R.H. at $+60\pm 2^{\circ}\text{C}$ for 500 hours and the being placed at ambient conditions for 8 hours, the transducer shall be measured.	The measured values shall meet Table 2
8-4	Heat Shock	After being kept at room temperature, the transducer shall be placed in a thermal chamber at temperature of -40°C . After 30 minutes at this temperature, the transducer shall be immediately placed in a chamber at temperature of $+85^{\circ}\text{C}$. After 30 minutes at this temperature, the transducer shall be returned to -40°C again. After 250 of the above cycles, the transducer shall be returned to ambient conditions where it shall remain for 8 hours prior to being measured.	The measured values shall meet Table 2

Table 2.

Electric Charge Sensitivity	$\pm 10\%$ (from initial value)
-----------------------------	-----------------------------------

Table 3.

Capacitance	$\pm 10\%$ (from initial value)
-------------	-----------------------------------

9. Dimensions and Indication

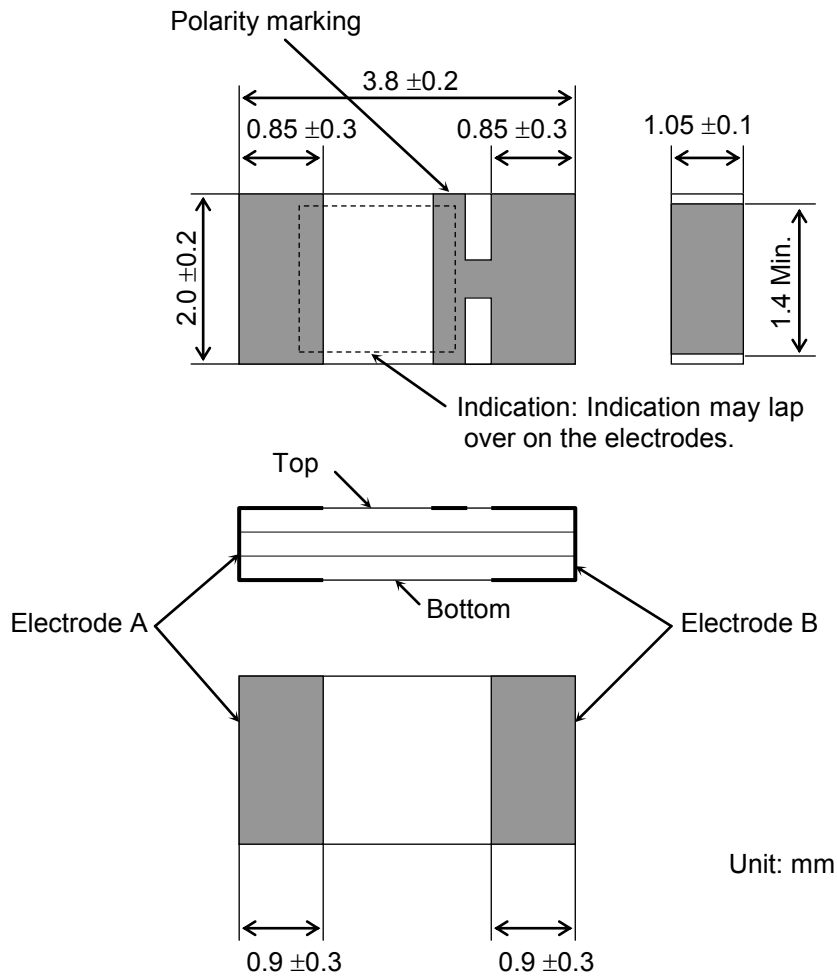
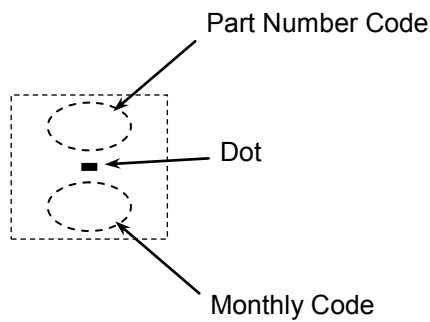

Figure 2. Dimensions

Indication contents

Part number code.....G

Monthly code.....Monthly code based on EIAJ-0901



10. Appearance criteria

10-1. Crack, Chip and Partial lack of electrode

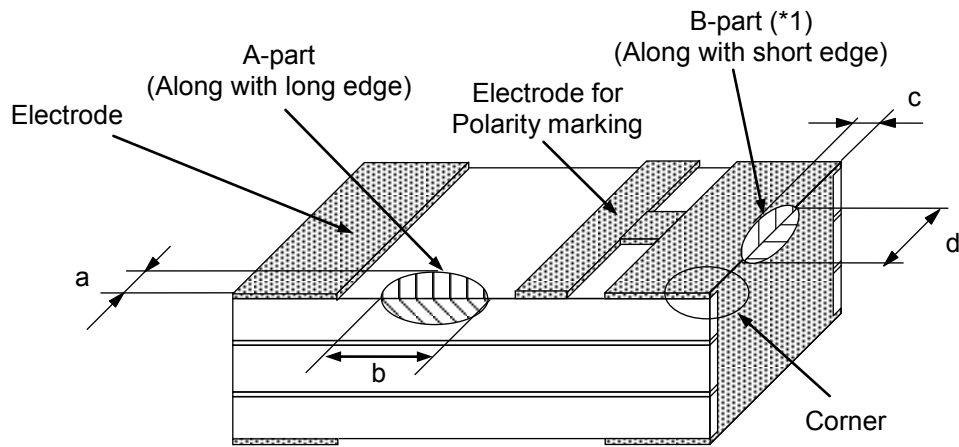

(*1) Any chips which is covered by electrode are judged as good.

- If crack or chip exist at corners, apply the above B-part standard.
- In case crack or chip reaches internal cavity, it is judged as failure even if length [b], [d] and width [a], [c] are met this specification.
- If there are two or more chips on B part, total length of [d] should be $\leq 1.2\text{mm}$

Criteria table for A part

		Unit [mm]	
		$0 < b \leq 0.4$	$0.4 < b$
$0 < a \leq 1.2$		G	G
$1.2 < a$		G	NG

Criteria table for B part

			Unit [mm]
			$0 < d \leq 0.4$
			$0.4 < d \leq 1.2$
			$1.2 < d$
$0 < c \leq 0.4$			G
$0.4 < c \leq 1.2$			NG
$1.2 < c$			NG

10-2. Electrode peeling and delamination

- Apply A-part standard to top and bottom electrode including polarity marking.
- Apply B-part standard to two-end electrode.

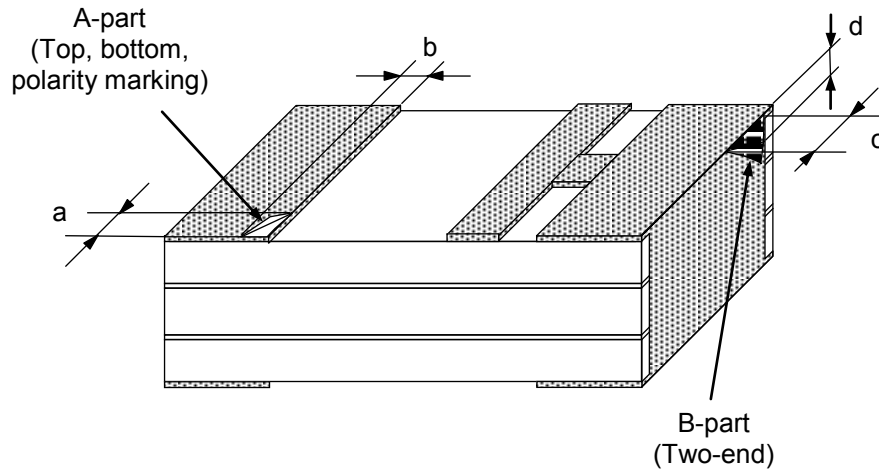

Criteria table for A part

		Unit [mm]		
		$0 < b \leq 0.4$	$0.4 < b \leq 0.85$	$0.85 < b$
$0 < a \leq 0.4$		G	G	G
$0.4 < a \leq 1.0$		G	G	NG
$1.0 < a$		G	NG	NG

Criteria table for B part

		Unit [mm]	
		$0 < d \leq 0.4$	$0.4 < d$
$0 < c \leq 1.0$		G	G
$1.0 < c$		G	NG

10-3. Electrode protrude and bridge

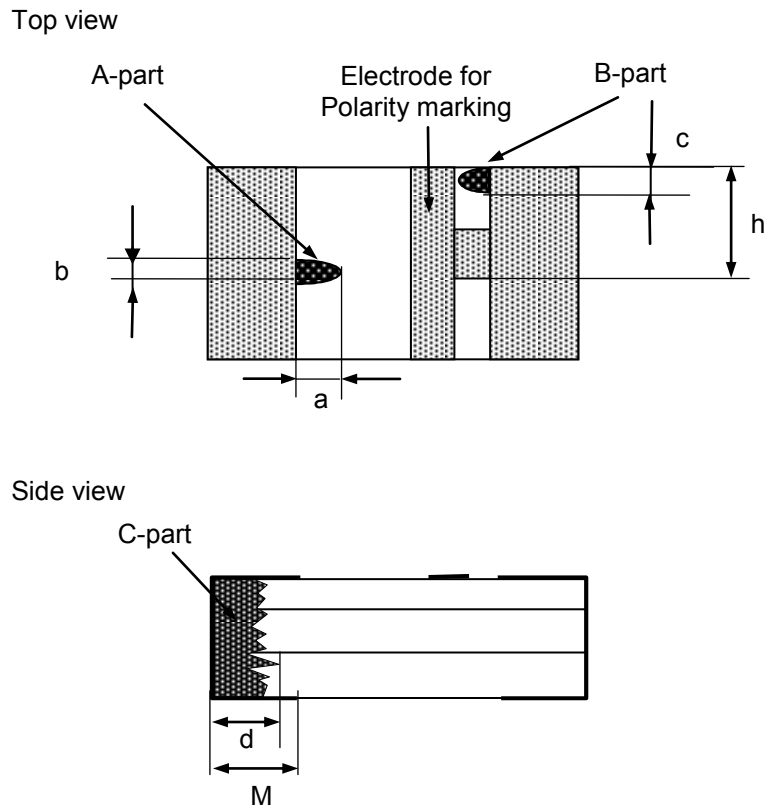

[A-part]

- If electrode protrude reaches opposite electrode, it should be failure.
- The same criteria are applied on the bottom electrode.

Criteria table for A part

	Unit [mm]	
	$0 < b \leq 0.4$	$0.4 < b$
$0 < a \leq 1.2$	G	G
$1.2 < a$	G	NG

[B-part]

Criteria table for B part

Unit [mm]	
$c \leq h$	$h < c$
G (*1)	NG

(*1) In case electrode protrude reaches to polarity marking, it should be good.

[C-part]

Criteria table for C part

Unit [mm]	
$d \leq M + 1.2$	$M + 1.2 < d$
G	NG

10-4. Center layer lack

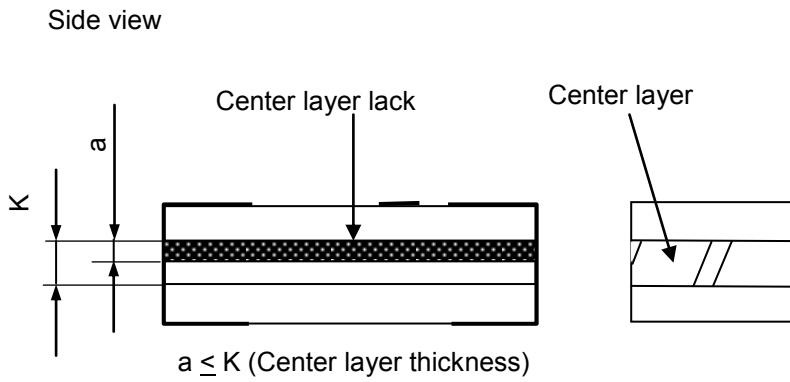

- Lack of center layer which facing side surface should be less than Center layer thickness.
- In case center layer lack reaches internal cavity, it is judged as failure.

10-5. Position of connection electrode

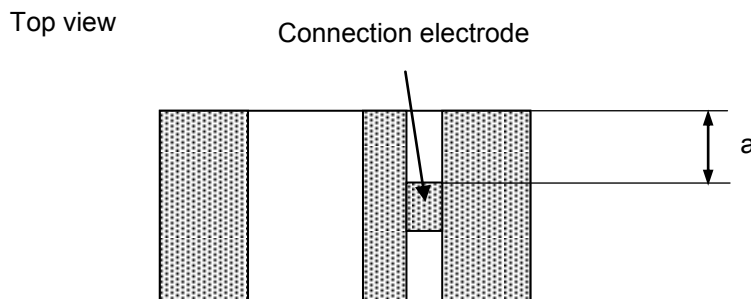

- It is judged as good regardless of the position of connection electrode

Unit [mm]	
$a \geq 0$	G

10-6. Partition of center layer

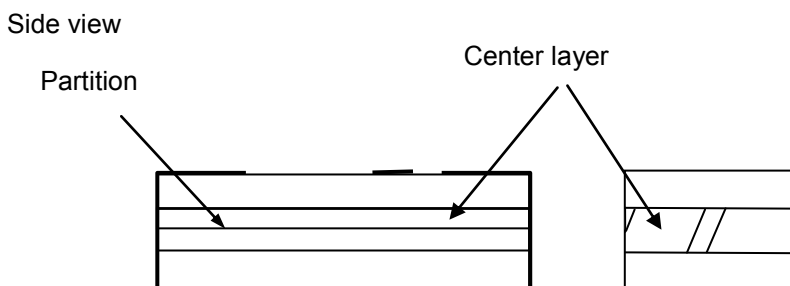

- No judgement on center-layer partition.

11. Taping Method

- 11-1 The tape for transducer shall be wound clockwise. The feeding holes shall be to the right side as the tape is pulled toward the user.
- 11-2 A reel shall contain 3,000 pcs of transducers and be clearly marked with part number, quantity, inspection number.

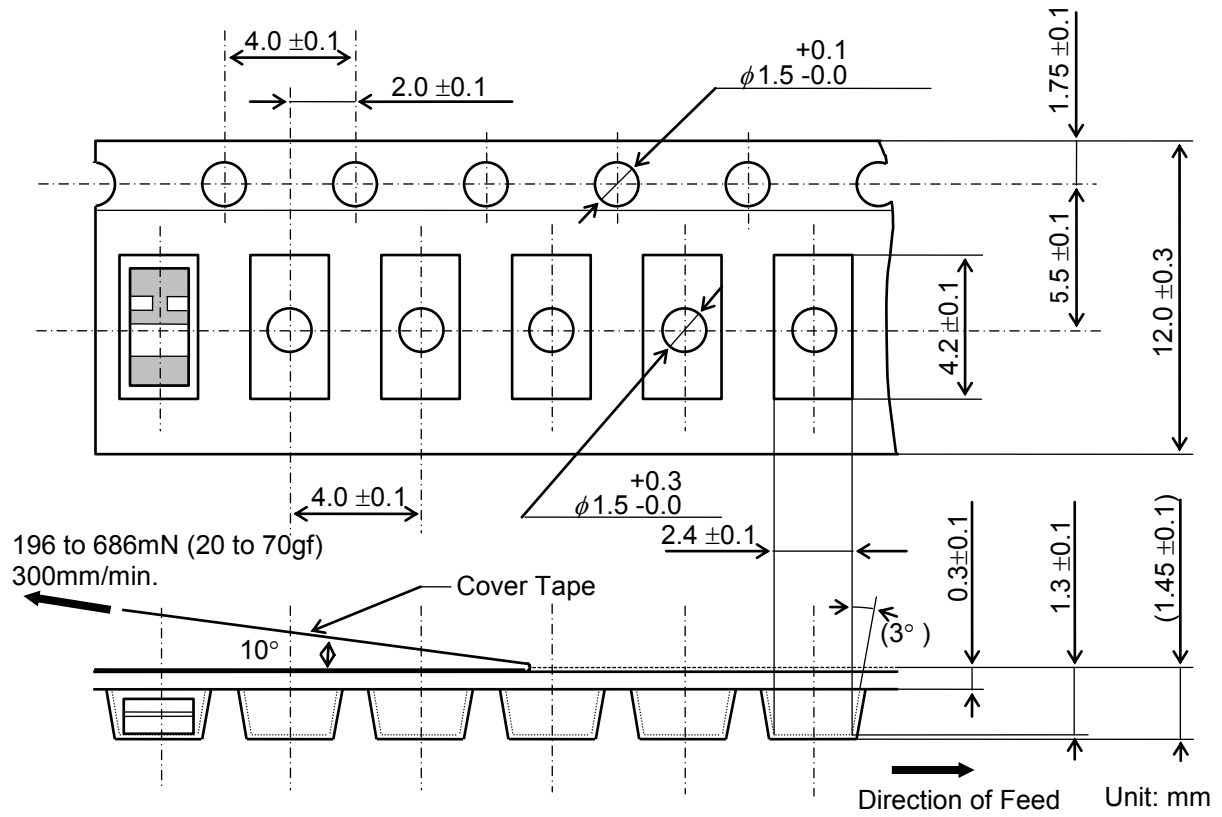

Figure.3 Dimension of Plastic Tape

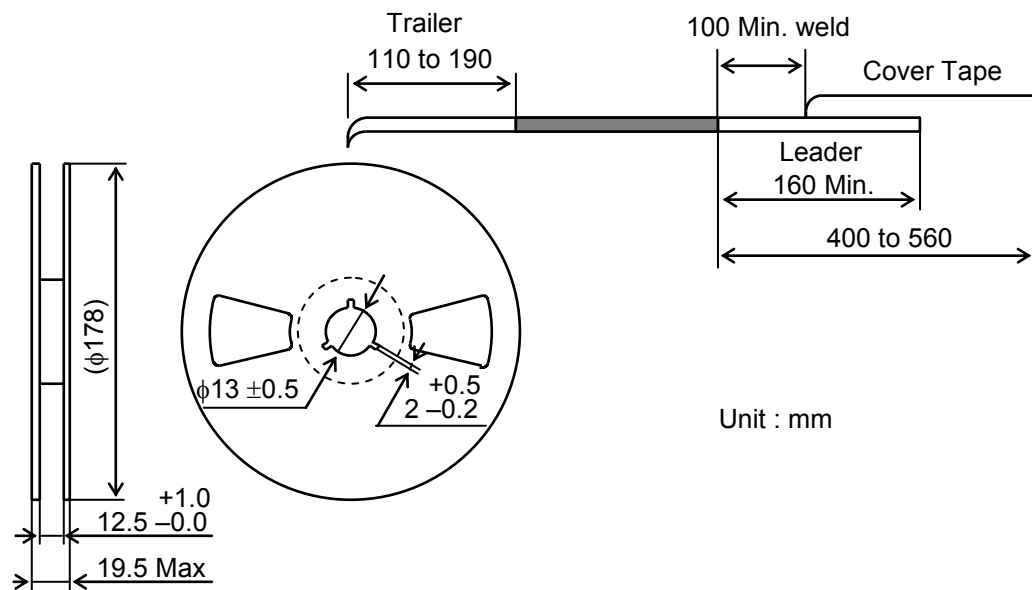

Figure.4 Dimension of Plastic Reel

12. ⚠ Caution (Application, Fail-safe)

12-1.Application Limitations

This product, the PKGS type shock sensor, has been designed for hard-disk drive applications, used in personal computers and consumer audio-visual equipments.

Please contact Murata before using this product in the applications listed below, which require especially high reliability for the prevention of defects which might directly cause damage to the third party's life, body or property, or when this product is intended for use in applications other than those specified in this data sheet. We shall not be liable for any claims on the product in case it is used in the listed applications below, without contacting us.

- | | | |
|--|---|-------------------------|
| (1) Cellular phone | (2) Automotive equipment other than the above mentioned | |
| (3) Outside use equipment | (4) Aircraft, Avionics equipment | (5) Aerospace equipment |
| (6) Under sea equipment | (7) Power plant control equipment | (8) Medical equipment |
| (9) Transportation equipment (vehicles, trains, ships, etc.) | (10) Industrial equipment | |
| (11) Traffic signal equipment | (12) Disaster prevention / crime prevention equipment | |
| (13) Safety device / system | (14) Military equipment (regardless of direct/indirect use) | |
| (15) Applications of similar complexity and/or reliability requirements to the applications listed in the above. | | |

12-2.Fail-safe

Be sure to provide an appropriate fail-safe function on your product to prevent damage that may be caused by the abnormal function or the failure of our product.

13. ⚠ Caution (Handling)

- 1) This product may be degraded by electrostatic discharge. We would suggest countermeasures against electrostatic discharge, before handling this product.
- 2) Please evaluate this product in your product; with it mounted to a Printed Circuit Board (PCB) or similar. We recommend that this product not be repeatedly mounted on or removed from a PCB by soldering, because of the possibility of degradation due to excessive heating to this product or electrostatic discharge (in case electrostatic discharge is not guarded against).

14. ⚠ Caution (Storage condition and usage environment)

- 1) Maximum storage period is for 6 months under the condition of 30°C and 70%RH before PCB mounting. If this product is kept in an especially high humidity environment, the product may degrade because of decreased insulation resistance value due to such conditions.
- 2) Please do not store and do not use this product in conditions that differ greatly from atmospheric pressure, such as a vacuum space, a high mountain, water, and so on. A pressure cooker test is not applicable for this product.
- 3) Please do not expose this product to dust, oil, corrosive gas, acid, or alkali. This product may be degraded if exposed.

15. ⚠ Caution (Design)

- 1) Please use a charge amplifier circuit. This specification is only valid for use with charge amplifiers. For instance, if you use a voltage amplifier circuit that is used with this product, we shall not be liable for any claims.
- 2) Please do not apply DC bias voltage to this product, because it causes degradation of insulation resistance value. Please try to keep minimizing the input bias current at front-end of amplifier circuit as well.
- 3) Please thoroughly evaluate this product for noise immunity. Noise, coming from the product (EMI) and/or generated by signal lines on PCB or other mechanical device (like a spindle motor), may result in the miss-operation or the non-operation of this product.
- 4) Please thoroughly evaluate this product in terms of mechanically accelerated transmission system, because this product may detect unexpected acceleration that is transmitted through PCB and/or through the frame of your product. Mechanical resonance on your product or individual vibration frequency of installed components/devices may create mutual interference, and it may result in incorrect measurement by the sensor.

- 5) Please do not apply excessive strain force or shock to this product that deviates from the conditions in this specification, because mechanical failure or damage could occur.
- 6) Please thoroughly evaluate this product in your manufacturing if you will use any conformal coating or potting process. These processes (for instance, in case resin type of material is used) could result in package breaks, due to heat shrink. Also, humidity that remains inside of the case, may affect circuit operation due to decreased insulation resistance value.
- 7) Physical and environmental characteristics for this product are described in this specification. Please consider these characteristics in evaluating this part in your product.
- 8) Please carefully design the application's housing to minimize dew and humidity. An amplifier circuit would have high impedance, 50M ohm for instance, but this value may decrease under a high humid environment. Due to this; you may not be able to see the intended performance from your circuit design, unless you consider these factors in your product design.
- 9) Please do not use this product in the presence of radiation rays or cosmic rays.
- 10) Please do not use this product in the presence of high electromagnetic fields.
- 11) Please consider the possibility of unexpected output signal-level generated by sharp temperature change. Please evaluate this product under all expected environmental conditions. We recommend a fail-safe function to compensate for any unexpected signal levels.
- 12) Pyroelectric noise may be seen on the output signal of this product, where there is a temperature variation (Δt) around the product. Δt may likely occur by airflow that is generated by a cooling fan that is often used in a computer. If your application requires a very small acceleration resolution, less than 0.1G with 50Hz or less for instance, we would suggest shutting off the airflow for increased accuracy in sensor detection.
- 13) This product is very sensitive to bending stress occurring on PCB, therefore please locate the sensor in an area on the PCB that is unaffected by bending stresses.

16. Caution (Mounting)

16-1 Reflow Soldering

- 1) Please use the standard footprint as shown in the specification. If you use a different one, we shall not be liable for any claims.
- 2) Please follow soldering conditions described in the specification. This product can permanently stop operating if the piezoelectric characteristic is decreased due to excessive heating.
- 3) Please follow the recommended washing conditions, as described in the specification.
- 4) Please make sure to evaluate the soldering condition with this product mounted on your PCB.

<Reflow temperature profile (reference only) >

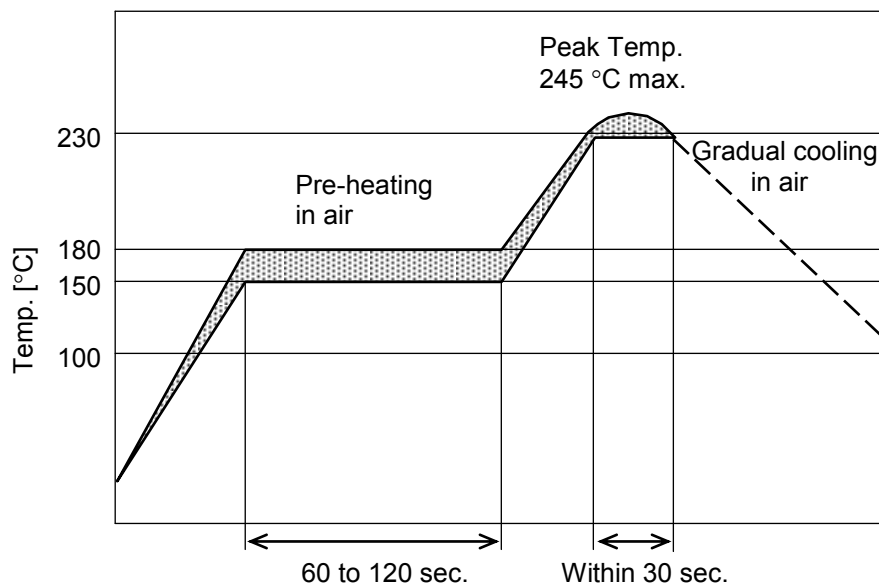

16-2 Soldering Iron

Use iron (3mm diameter or less, 45W max.) and iron temp should be 350°C max. within 3 sec. at only one point. Please take care to avoid soldering iron from touching the product directly.

17.  Note

- 1) Please make sure that the final product has been evaluated to all your product's specifications, with this product mounted inside.
- 2) All the items and parameters in this product specification have been prescribed on the premise that our product is used for the purpose, under the conditions, and in the environment agreed upon between us. You are requested not to use our product deviating from this product specification.
- 3) We consider it inappropriate to include any terms or conditions with regard to the business transactions in the product's specification, drawing, or other technical document. Therefore, if your technical document includes any of the above items, such as warranty clause, product liability clause, or intellectual property infringement liability clause, they will be deemed to be invalid.