

TRANSIL™ diode for ESD protection

Features

- Max peak pulse power 160 W (8/20 μ s)
- Asymmetrical bidirectional device
- Stand-off voltage: 15 and 24 V
- Low clamping factor V_{CL}/V_{BR}
- Complies with the following standards :
 - IEC 61000-4-2 level 4 (> 15 kV air discharge, > 8 kV contact discharge)
 - IEC 61000-4-5; I_{pp} = 3 A (8/20 μ s)
 - HBM MIL STD 833, class 3 (> 4 kV)
- Low Leakage current

Description

The ESDLIN1524BJ is an asymmetrical TRANSIL diode designed specifically for protecting one automotive LIN bus line against electrostatic discharge (ESD). The SOD-323 is a very small package which allows space saving on high density printed circuit board .

Transil diodes provide high overvoltage protection by clamping action and have instantaneous response to transient overvoltages.

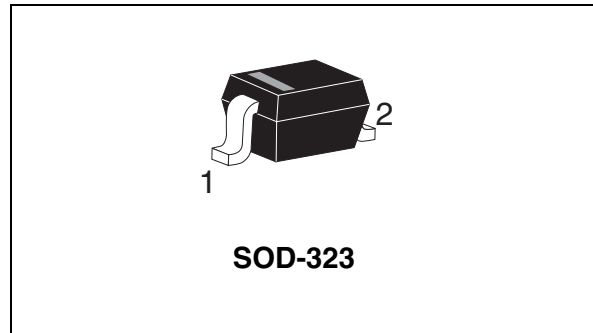

Configuration

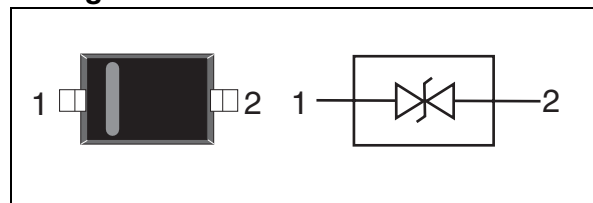

Pin	Description
1	Cathode 1 (15 V reverse stand-off voltage)
2	Cathode 2 (24 V reverse stand-off voltage)

Table 1. Absolute maximum ratings (limiting values) $T_{amb} = 25^{\circ}C$

Symbol	Parameter	Value	Unit
P_{PP}	Peak pulse power dissipation 8/20 μ s ⁽¹⁾	160	W
T_{stg} T_j	Storage temperature range Operating junction temperature range	-65 to +175 -40 to 150	$^{\circ}C$
T_L	Maximum lead temperature for soldering during 10 s	260	$^{\circ}C$

1. For a surge greater than maximum values, the diode will fail in short-circuit

Table 2. ESD Maximum ratings

Symbol	Parameter	Conditions	Value	Unit
ESD	Electrostatic discharge capability	IEC 61000-4-2 (contact discharge)	23	kV
		HBM MIL STD 833	10	

TM: TRANSIL is a trademark of STMicroelectronics.

1 Characteristics

Table 3. Electrical characteristics ($T_{amb} = 25^{\circ}C$)

Symbol	Parameter
V_{RM}	Stand-off voltage
V_{BR}	Breakdown voltage
V_{CL}	Clamping voltage
I_{RM}	Leakage current @ V_{RM}
I_R	Breakdown current @ V_{BR}
I_{PP}	Peak pulse current
C	Junction capacitance

Types	$I_{RM} @ V_{RM}$		V	$V_{BR} @ I_R^{(1)}$			mA	$V_{CL} max @ I_{PP} 8/20 \mu s$				C ⁽²⁾		$\alpha T^{(3)}$
	nA			V				V	A	V	A	pF		$10^{-4}/^{\circ}C$
	Typ	Max	Min	Typ	Max	V	A	V	A	Typ	Max	Max		
ESDLIN1524BJ(15V)	1	50	15	17.1	18.9	20.3	5	25	1	35	5	16	20	8.8
ESDLIN1524BJ(24V)	1	50	24	25.4	27.8	30.3	5	40	1	50	3			9.6

1. Pulse test: $t_p < 50$ ms
2. $V_R = 0$ V, $F = 1$ MHz
3. $\Delta V_{BR} = \alpha T \times (T_{amb} - 25) \times V_{BR(25^{\circ}C)}$

Figure 1. Relative variation of peak pulse power versus initial junction temperature

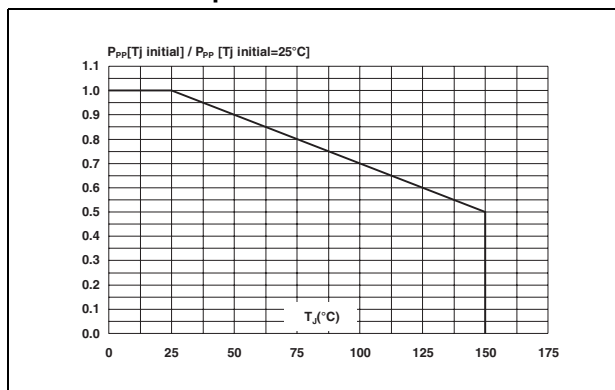

Figure 2. Peak pulse power versus exponential pulse duration

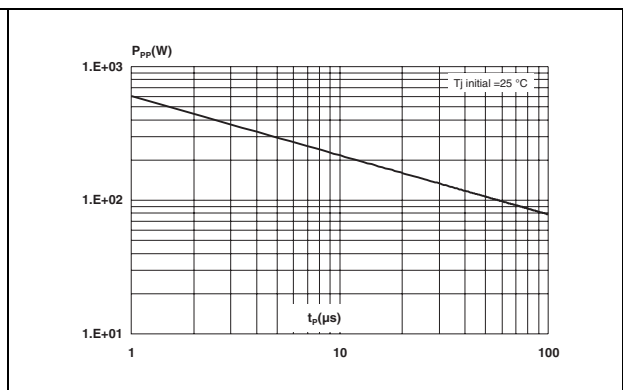

Figure 3. Junction capacitance versus line voltage (typical values), 15 V side

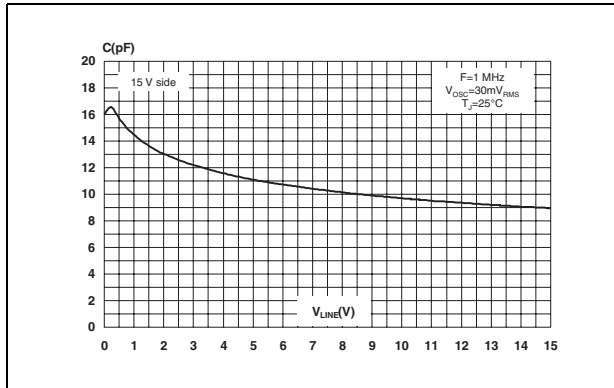

Figure 4. Junction capacitance versus line voltage (typical values), 24 V side

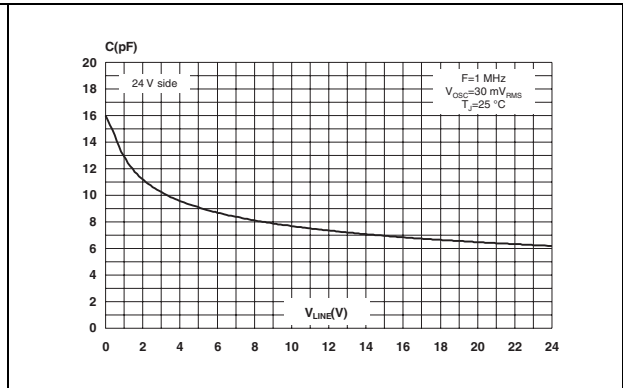
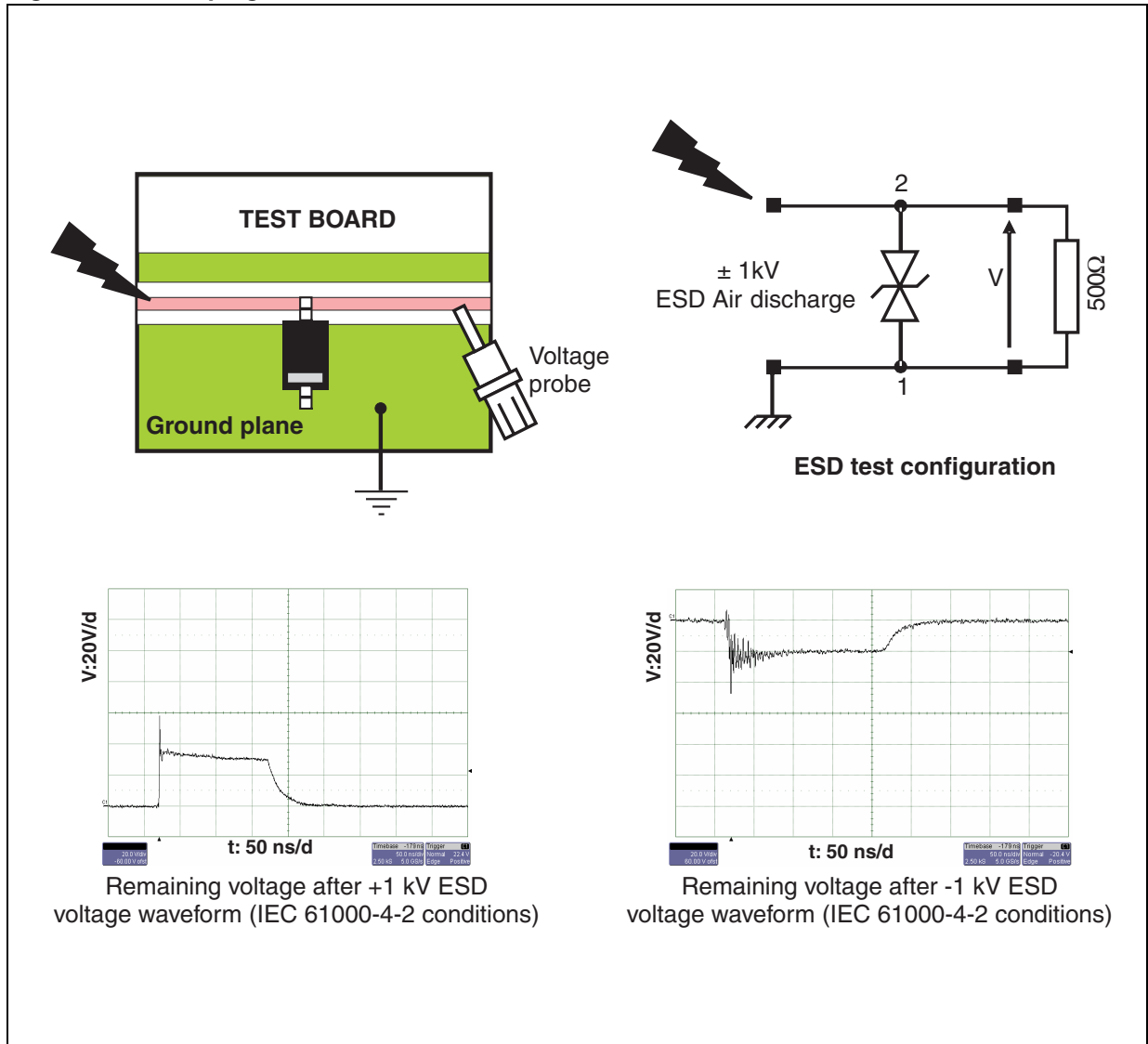

Figure 5. Clamping test conditions and results



2 Placement and PCB layout recommendations

Figure 6. illustrates recommendations for the placement and layout of the PCB for optimum benefit of the ESDLIN1524BJ.

Figure 6. Placement and PCB layout recommendations

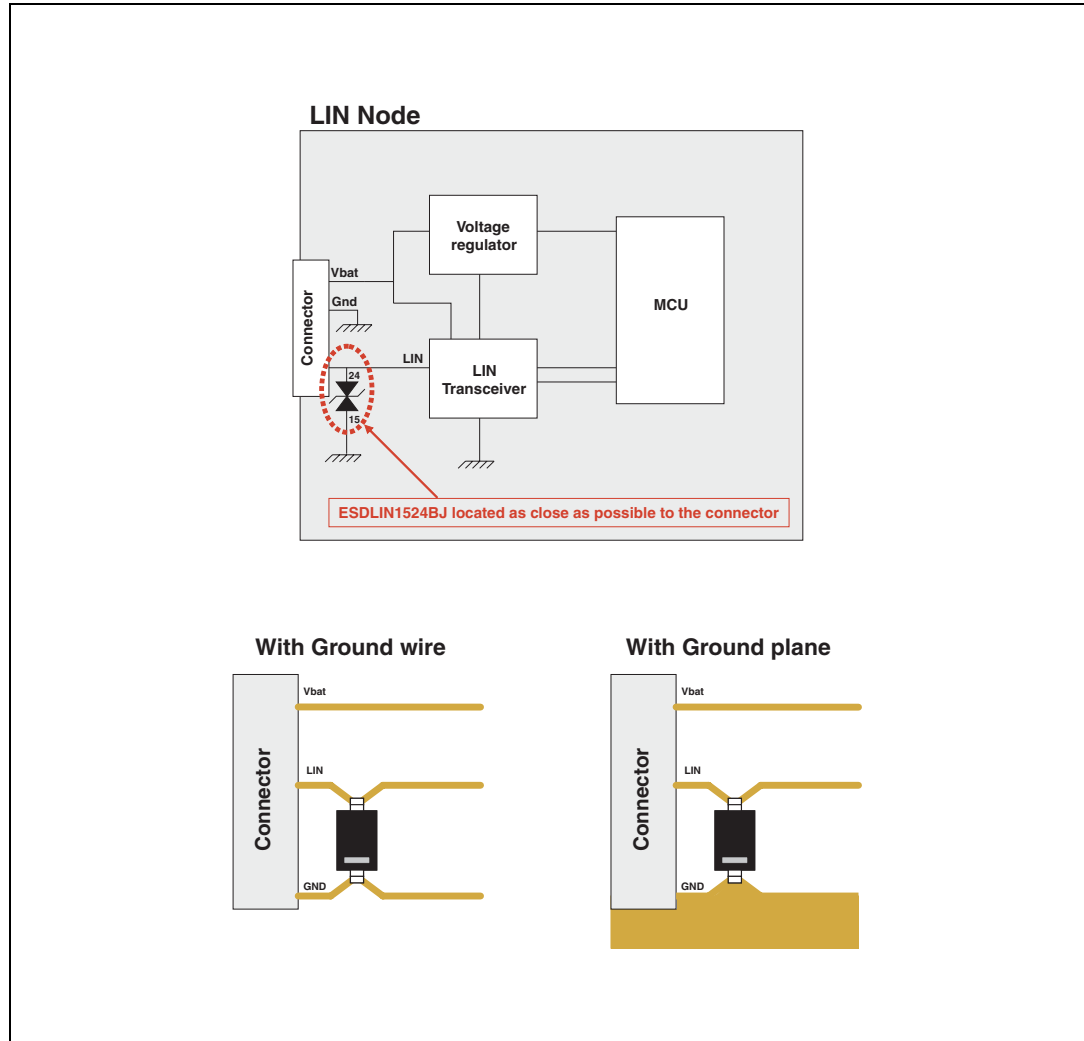

3 Ordering information scheme

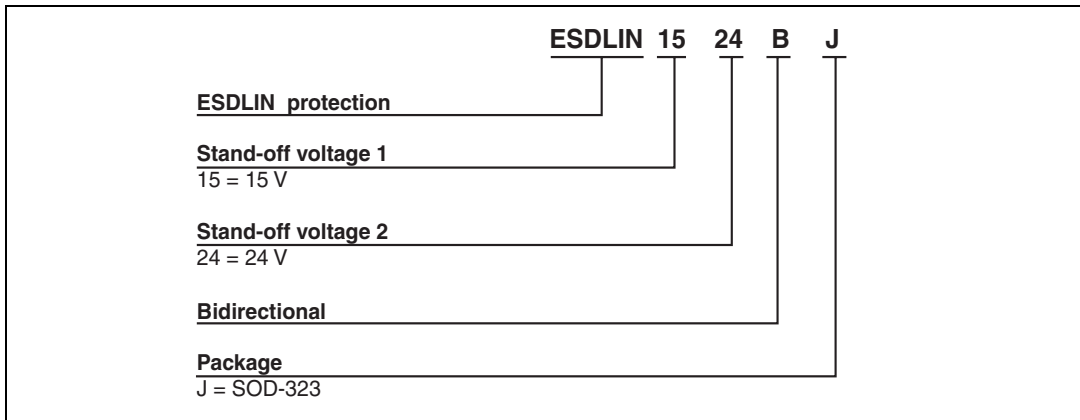

4 Package information

Table 4. SOD-323 dimensions

Ref.	Dimensions			
	Millimeters		Inches	
	Min.	Max.	Min.	Max.
A		1.17		0.046
A1	0	0.1	0	0.004
b	0.25	0.44	0.01	0.017
c	0.1	0.25	0.004	0.01
D	1.52	1.8	0.06	0.071
E	1.11	1.45	0.044	0.057
H	2.3	2.7	0.09	0.106
L	0.1	0.46	0.004	0.02
Q1	0.1	0.41	0.004	0.016

Figure 7. SOD-323 footprint (dimensions in millimeters)

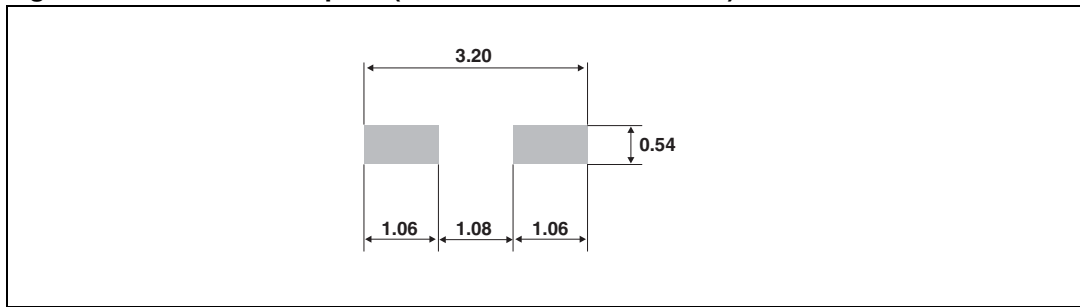

In order to meet environmental requirements, ST offers these devices in ECOPACK® packages. These packages have a lead-free second level interconnect. The category of second level interconnect is marked on the package and on the inner box label, in compliance with JEDEC Standard JESD97. The maximum ratings related to soldering conditions are also marked on the inner box label. ECOPACK is an ST trademark. ECOPACK specifications are available at: www.st.com.

5 Ordering information

Part number	Marking	Package	Weight	Base qty	Delivery mode
ESDLIN1524BJ	24	SOD-323	5 mg	3000	Tape and reel

6 Revision history

Date	Revision	Changes
28-Aug-2006	1	Initial release.
22-Sep-2006	2	Added Figure 6 Placement and layout recommendations.

Please Read Carefully:

Information in this document is provided solely in connection with ST products. STMicroelectronics NV and its subsidiaries ("ST") reserve the right to make changes, corrections, modifications or improvements, to this document, and the products and services described herein at any time, without notice.

All ST products are sold pursuant to ST's terms and conditions of sale.

Purchasers are solely responsible for the choice, selection and use of the ST products and services described herein, and ST assumes no liability whatsoever relating to the choice, selection or use of the ST products and services described herein.

No license, express or implied, by estoppel or otherwise, to any intellectual property rights is granted under this document. If any part of this document refers to any third party products or services it shall not be deemed a license grant by ST for the use of such third party products or services, or any intellectual property contained therein or considered as a warranty covering the use in any manner whatsoever of such third party products or services or any intellectual property contained therein.

UNLESS OTHERWISE SET FORTH IN ST'S TERMS AND CONDITIONS OF SALE ST DISCLAIMS ANY EXPRESS OR IMPLIED WARRANTY WITH RESPECT TO THE USE AND/OR SALE OF ST PRODUCTS INCLUDING WITHOUT LIMITATION IMPLIED WARRANTIES OF MERCHANTABILITY, FITNESS FOR A PARTICULAR PURPOSE (AND THEIR EQUIVALENTS UNDER THE LAWS OF ANY JURISDICTION), OR INFRINGEMENT OF ANY PATENT, COPYRIGHT OR OTHER INTELLECTUAL PROPERTY RIGHT.

UNLESS EXPRESSLY APPROVED IN WRITING BY AN AUTHORIZED ST REPRESENTATIVE, ST PRODUCTS ARE NOT RECOMMENDED, AUTHORIZED OR WARRANTED FOR USE IN MILITARY, AIR CRAFT, SPACE, LIFE SAVING, OR LIFE SUSTAINING APPLICATIONS, NOR IN PRODUCTS OR SYSTEMS WHERE FAILURE OR MALFUNCTION MAY RESULT IN PERSONAL INJURY, DEATH, OR SEVERE PROPERTY OR ENVIRONMENTAL DAMAGE. ST PRODUCTS WHICH ARE NOT SPECIFIED AS "AUTOMOTIVE GRADE" MAY ONLY BE USED IN AUTOMOTIVE APPLICATIONS AT USER'S OWN RISK.

Resale of ST products with provisions different from the statements and/or technical features set forth in this document shall immediately void any warranty granted by ST for the ST product or service described herein and shall not create or extend in any manner whatsoever, any liability of ST.

ST and the ST logo are trademarks or registered trademarks of ST in various countries.

Information in this document supersedes and replaces all information previously supplied.

The ST logo is a registered trademark of STMicroelectronics. All other names are the property of their respective owners.

© 2006 STMicroelectronics - All rights reserved

STMicroelectronics group of companies

Australia - Belgium - Brazil - Canada - China - Czech Republic - Finland - France - Germany - Hong Kong - India - Israel - Italy - Japan - Malaysia - Malta - Morocco - Singapore - Spain - Sweden - Switzerland - United Kingdom - United States of America

www.st.com