

RoHS **PLED5 QFN Series**

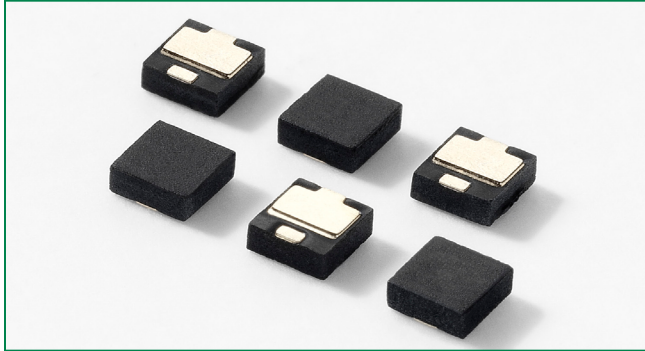

Schematic Symbol

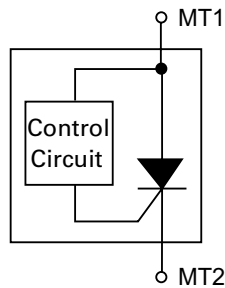

Description

This PLED5 Open LED Protector device provides three methods for increasing the reliability of LED lighting:

- 1) If one of the LEDs in an array fails open, this device provides a substitute electronic path so that the array continues to function
- 2) It protects against ESD events up to ± 8 kV for contact discharges and ± 15 kV for air discharges per the IEC 61000-4-2 electrostatic immunity standard.
- 3) It provides protection in the case of accidental reverse battery or power connection.

High reliability of lighting functions such as traffic lighting, aircraft lighting, advertising lighting, and runway lighting demand the use of a device such as the PLED5.

Littelfuse offers over current devices for implementation in power circuits that can also enhance the reliability of circuit operation. Our full line of circuit protection products can be viewed at www.littelfuse.com.

Features & Benefits

- Reverse Battery/Power Protection
- ESD, IEC 61000-4-2, ± 8 kV contact, ± 15 kV air
- Open LED bypass up to 500 mA
- Fast Switching
- Resets After Power Cycle
- Low Turn-On (Trigger Voltage)
- Ideal for MR16, PAR type lamps

Electrical Characteristics

Symbol	Parameter	Conditions	MIN	TYP	MAX	Unit
V_{AK}	Input Voltage				40	V
V_{TO}	Turn-On Voltage		4.65	4.9	5.15	V
I_S	Switching Current				20	mA
V_{OS}	On-State Voltage	$I_{AK} = 350$ mA		1	1.3	V
I_{OS}	On-State Current	(with adequate heat sinking)			500	mA
V_{OSR}	Reverse On-State Voltage	$I = 350$ mA		1	1.4	V
I_{OSR}	Reverse On-State Current				500	mA
I_{DRM}	Leakage Current	$V_{AK} = 3.5$ V		100	150	μ A
V_{ESD}	ESD Withstand Voltage ¹	IEC61000-4-2 (Contact)		± 8		kV
		IEC61000-4-2 (Air)		± 15		kV

Notes:

¹Parameter is guaranteed by design and/or device characterization.

Thermal Considerations

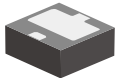
Package	Symbol	Parameter	Value	Unit
 QFN	T_{OP}	Operating Temperature	-40 to 85	°C
	T_J	Maximum Junction Temperature	150	°C
	T_{STOR}	Storage Temperature	-65 to 150	°C

V-I Characteristics

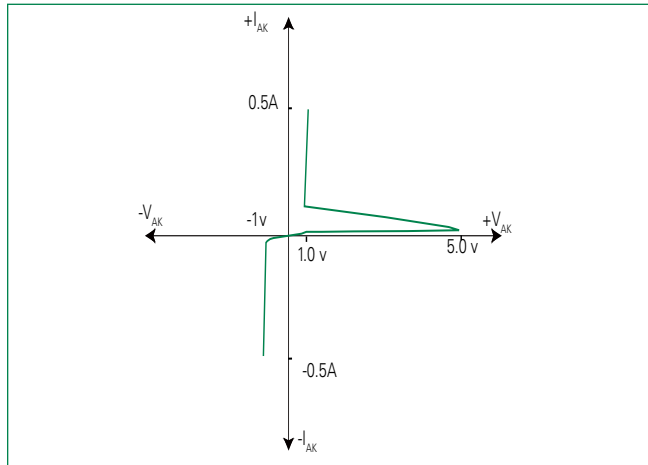

Switching Current vs Temperature

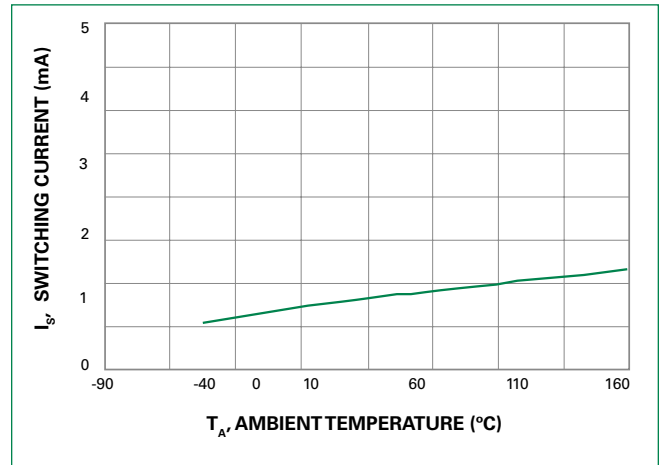

Holding Current vs Temperature

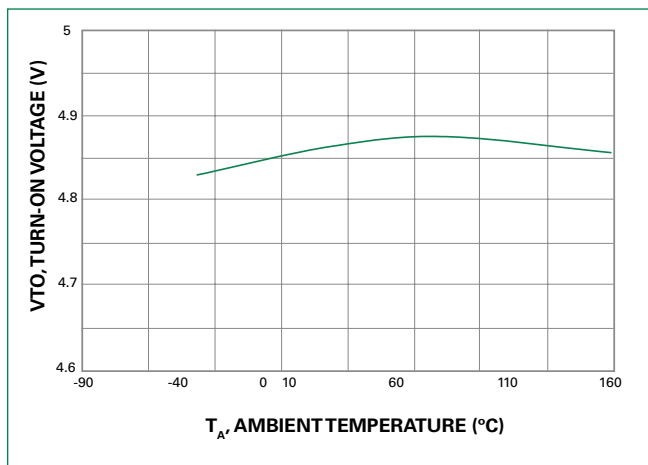

LED Application and Interference Test Circuit

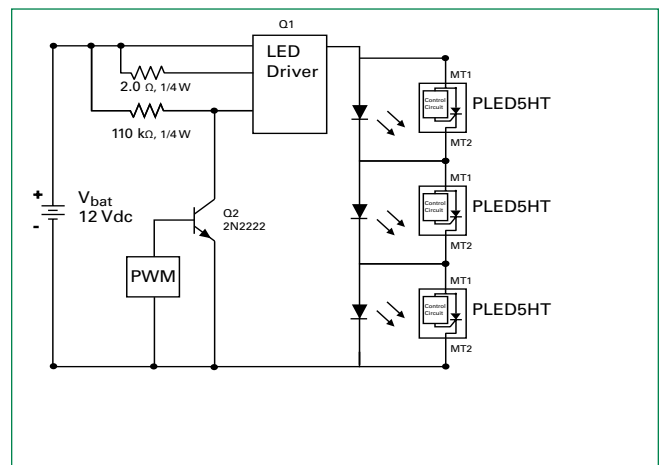

Package Dimensions

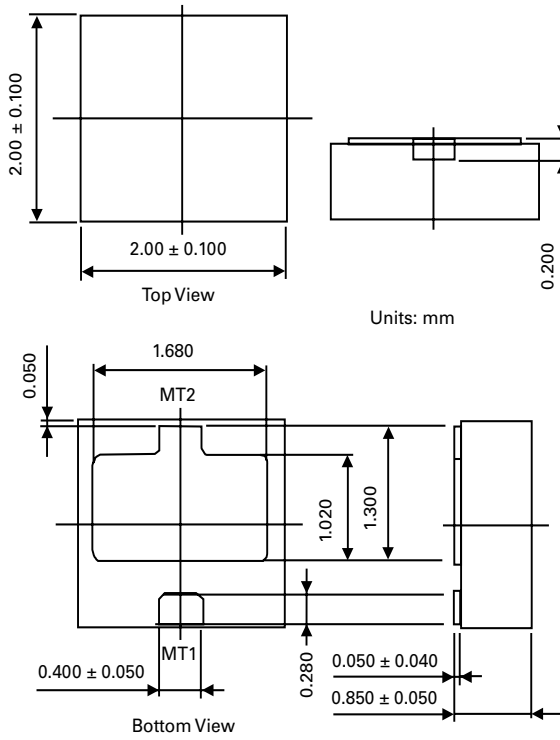

Leakage Current vs Temperature

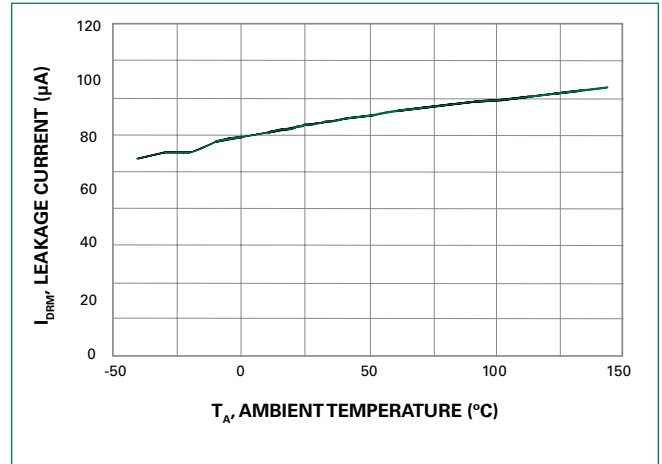

Ordering Information

Catalog Number	Package Type	Quantity Per Reel
PLED5Q12	QFN	3000 Pieces