

BUGGY

A motorized development platform

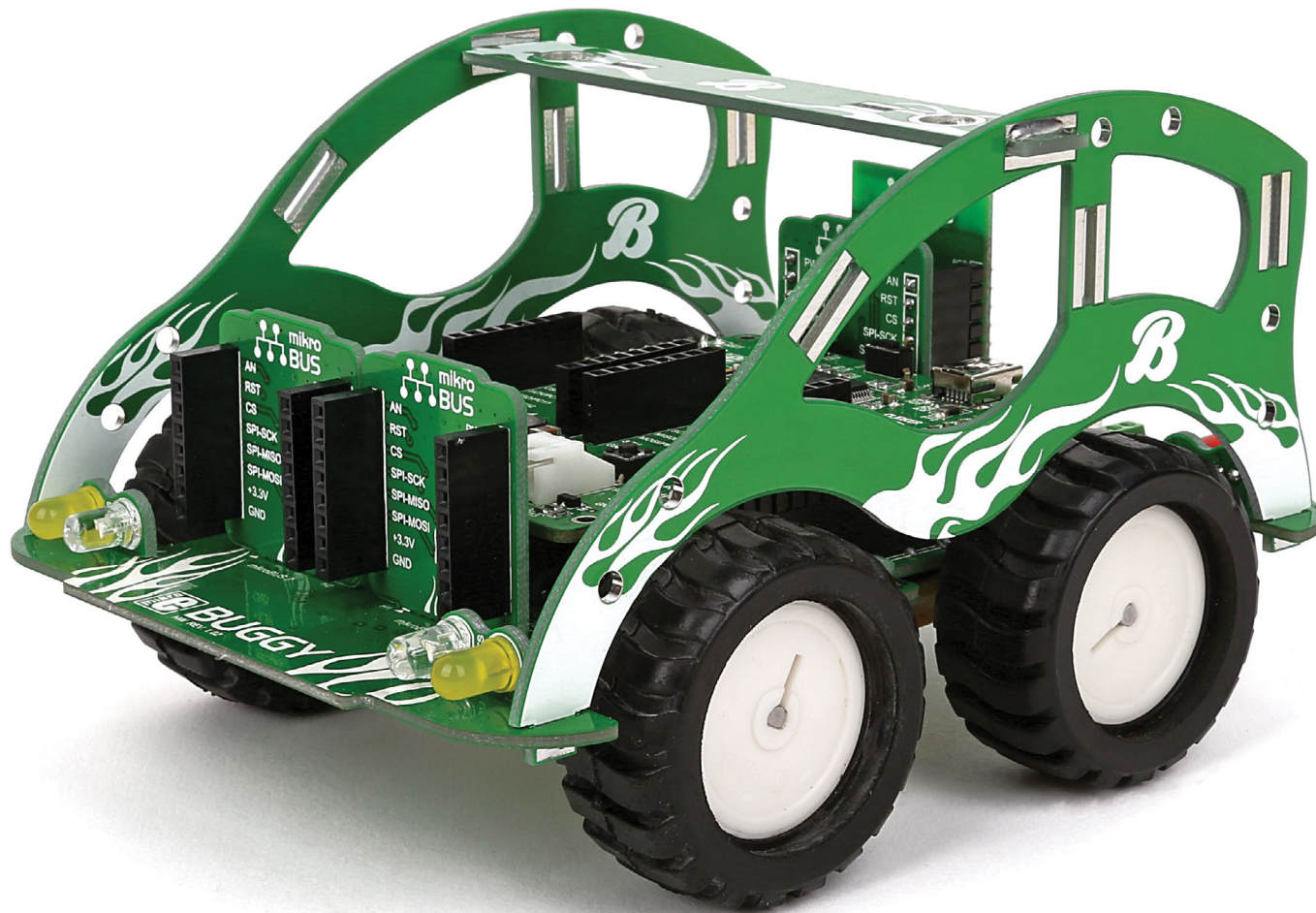



To our valued customers

I want to express my thanks to you for being interested in our products and for having confidence in MikroElektronika.

The primary aim of our company is to design and produce high quality electronic products and to constantly improve the performance thereof in order to better suit your needs.

We hope you'll have great fun with the Buggy, and that it'll be a great learning experience as well.

Nebojsa Matic,
Owner and General Manager
of MikroElektronika

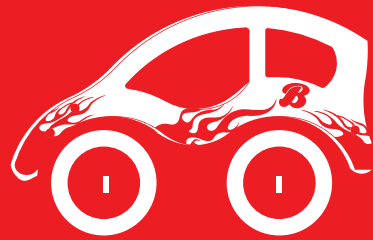

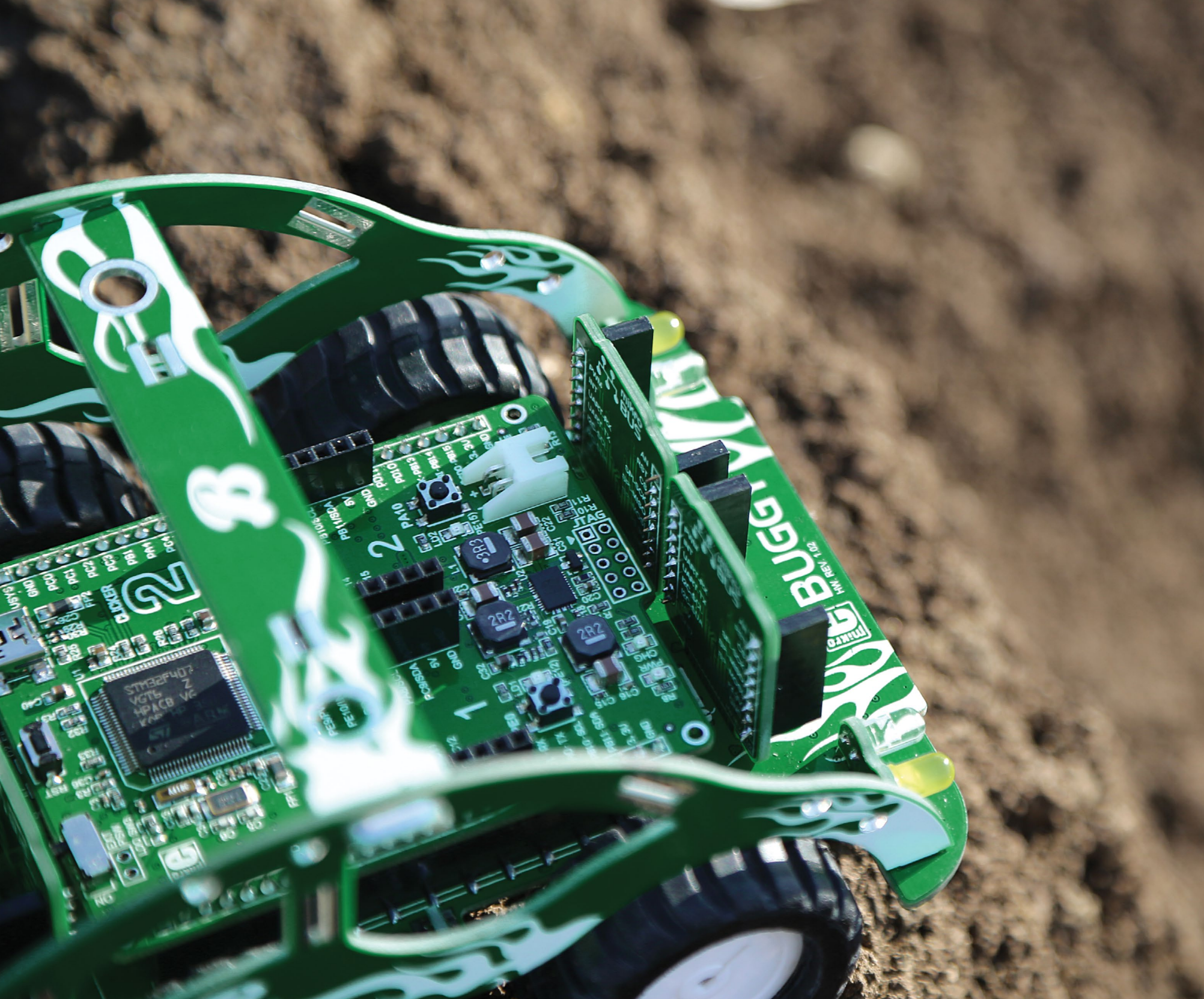



Table of contents

Introduction	6	Motors	20
Package contains	7	Power supply	21
It has the look and the features	8	mikroBUS™ sockets	22
Assembling	10	click™ boards	23
Choose your driver	17	Firmware	24
clicker 2 & mikromedia pinout	18	Android app	24
clicker 2 - a click™ board two-seater	19	Schematic	25
Lights	20	What's Next?	26

Introduction



For years we have been honing our expertise in designing powerful and easy to use hardware development tools. Our reputation was forged, in part, on our range of mikromedia boards and the ever-growing line of click™ boards. This time, we've put all that experience to use, and put it on wheels – **the Buggy is a four-wheel robotics workstation that takes advantage of all the innovations we came up with in recent years:** it employs a clicker 2 / mikromedia pinout that makes it **compatible with a wide range of microcontroller architectures.** Then we added mikroBUS™ sockets giving you the choice of over 100 click™ boards to enhance the four-wheeler and make it your own with various sensors and communication boards. We also published a **free Android App** for remotely controlling the Buggy and we made the code available to you. Finally, we took great care to provide you with the relevant documentation to make it easy to start working on your Buggy projects right away. Hence this manual. **Enjoy.**



Package dimensions:
L 277mm, W 232mm, H 56mm



Package weight:
~800-850g



Power supply
3.7V, 2000mAh LiPo battery



Four-wheel
clicker 2 or
mikromedia
workstation

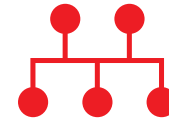

Three additional
click™ board sockets,
additional outputs,
mounting holes



ANDROID

Open source
Android App to
jump-start your
development

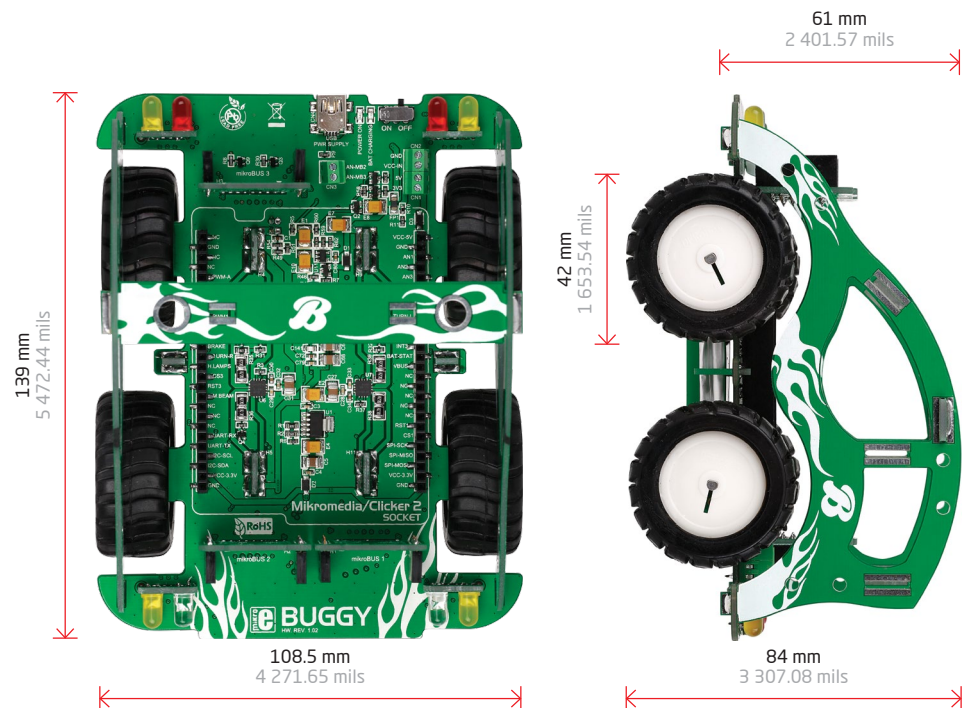

Package contains

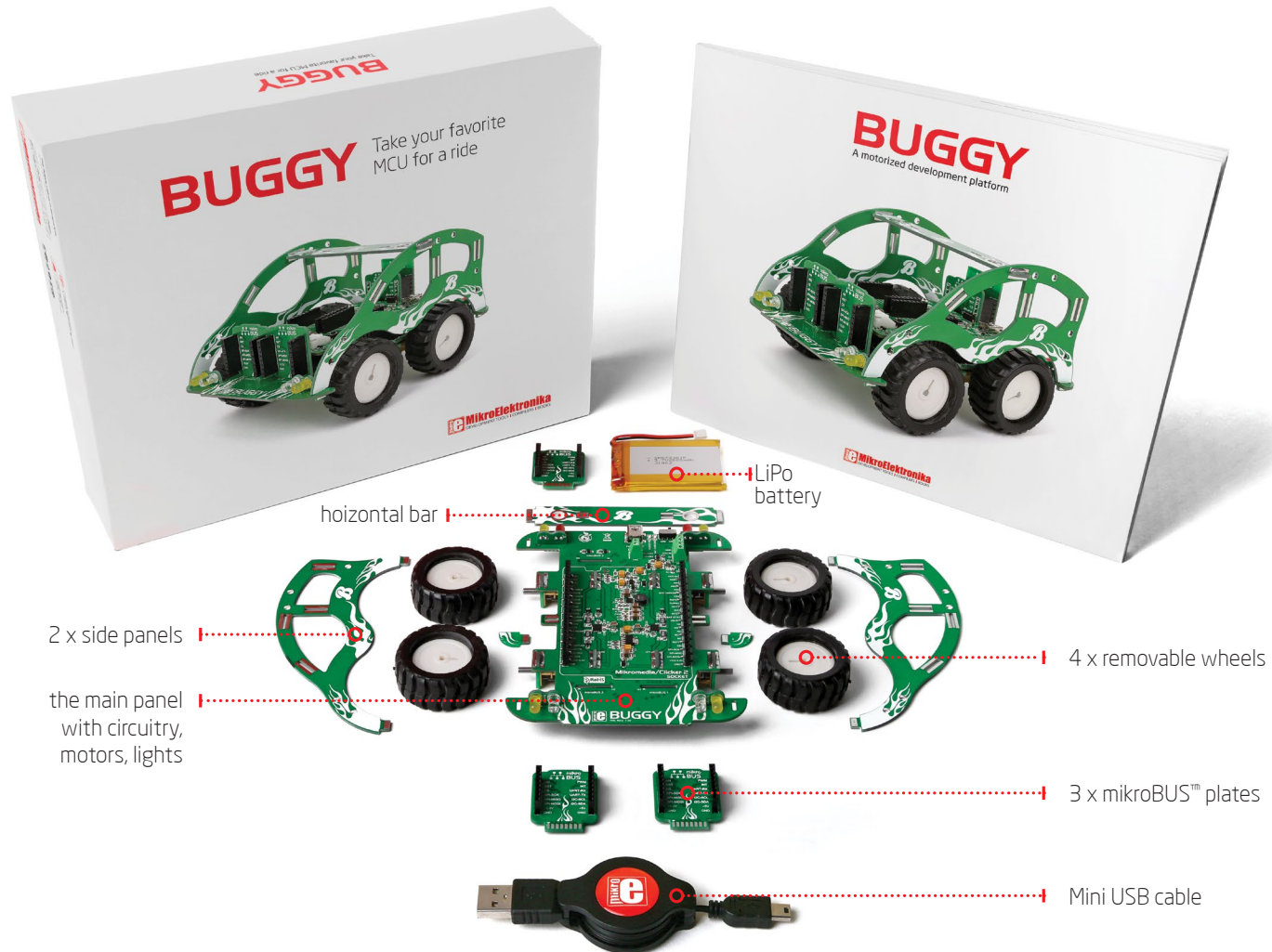

The kit contains 1) the main panel with circuitry, motors, lights, and the mikromedia connector; 2) a pair of battery holder tabs; 3) two side panels and a horizontal bar; 4) three mikroBUS™ plates; and 5) four wheels.



It has the looks...

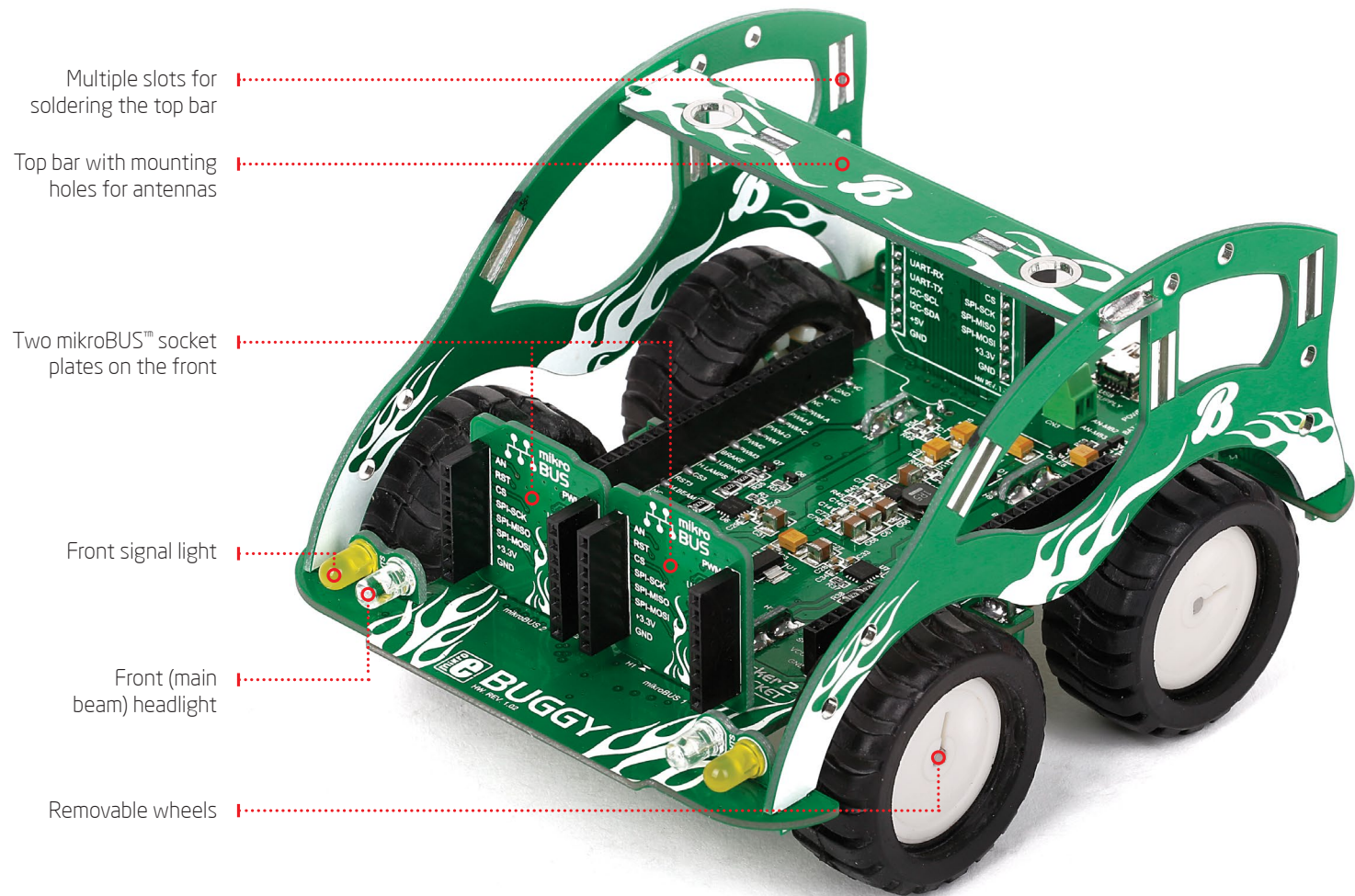

... and the features

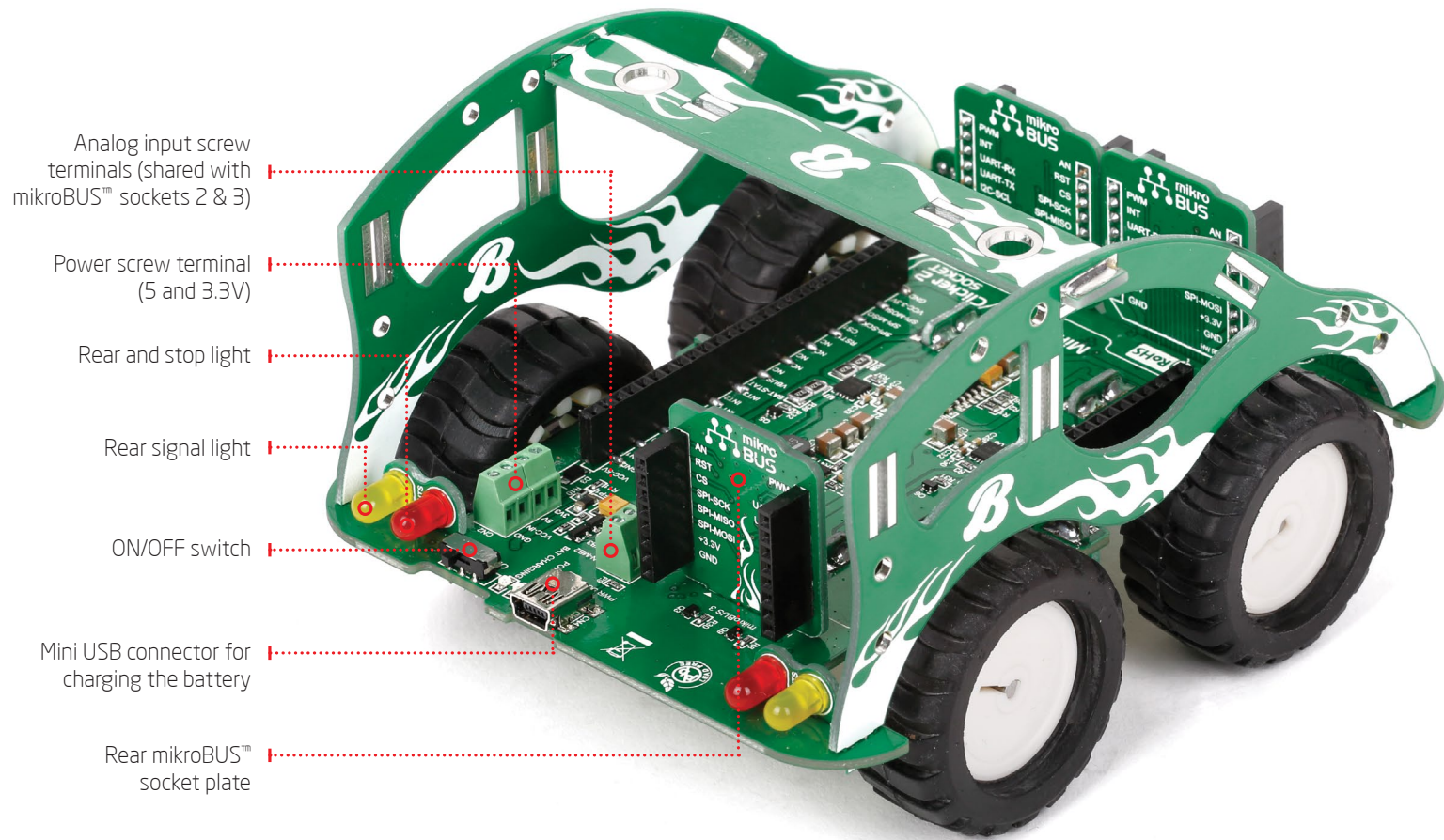

Assembly

With basic soldering skills you'll assemble the Buggy in no time. Check out the "package contains" section on page 7 to make sure you have everything prepared. Then proceed with step 1 and all the way through.

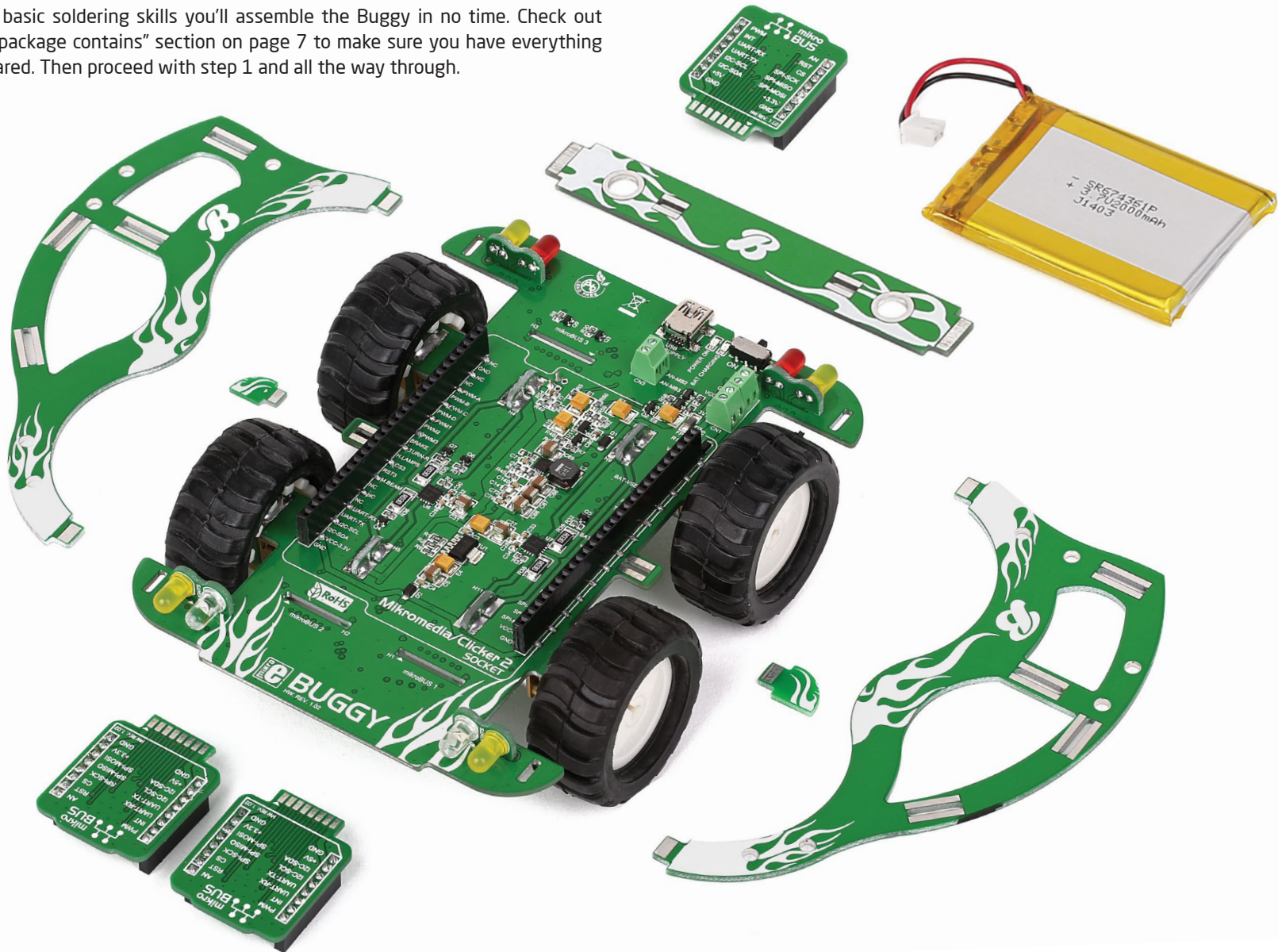

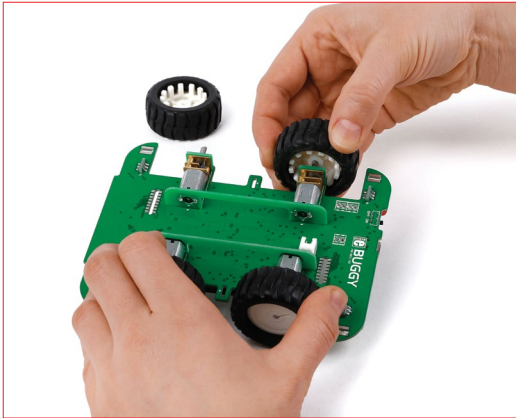

STEP 1 - Remove wheels from one side

The Buggy's main board is packed in the box with wheels attached. Remove both wheels from the left side of the board, by pulling on them.

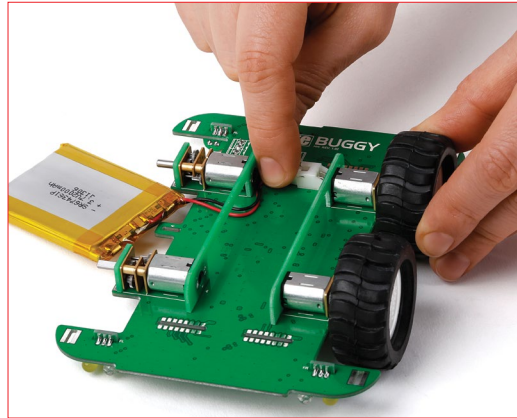

STEP 2 - Connect the battery

Pull the battery wire under the rail and attach it to the battery connector.

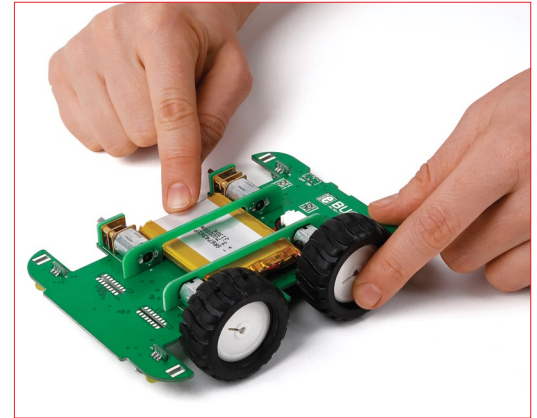

STEP 3 - Insert the battery

Push the whole battery under the rail. Be careful not to pinch the wire. The battery should fit squarely between Buggy's four motors.

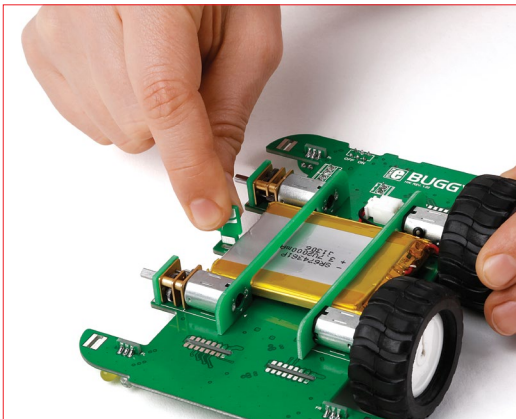

STEP 4 - Insert battery holder tabs

Look for the two smallest pieces of PCB in the box. Those are the supporting tabs that keep the battery in place. Pick either one and place it in the sockets on either side of the board, so that the curved side is facing outwards

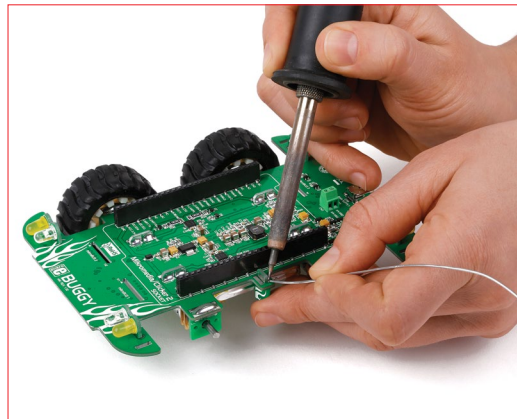

STEP 5 - Solder battery holder tabs

Hold the battery-holder tab and flip the main board so that the battery is now facing downwards. Solder the tab. Repeat step 4 and 5 for the second battery-holder tab.

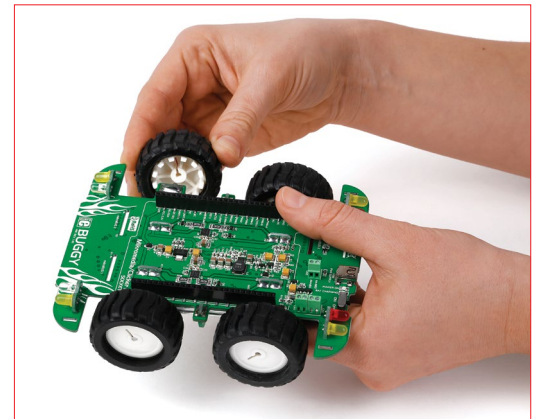

STEP 6 - Reattach the wheels

The axle and the socket on the wheel are not completely round, so be careful to correctly align them before pushing the wheel towards the axle.



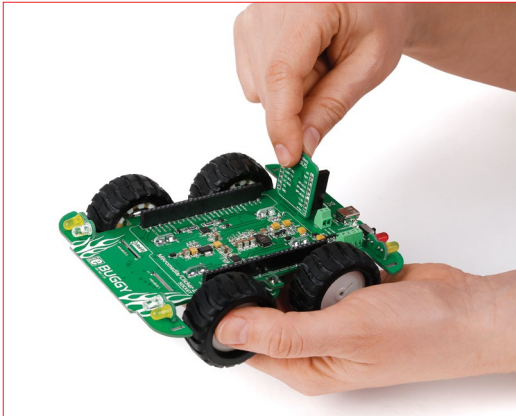

STEP 7 - Insert mikroBUS™ socket plates

The Buggy comes with three additional mikroBUS™ socket plates. Pick either one and slip it inside one of the three slits on the main board, marked mikroBUS 1, mikroBUS 2, and mikroBUS 3.

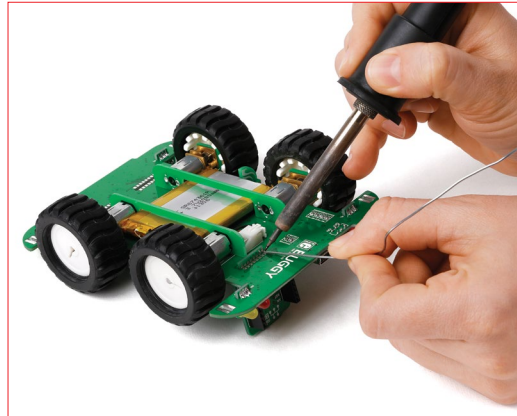

STEP 8 - Solder mikroBUS™ socket plates

While holding the mikroBUS™ socket plate inside the slit with your finger, flip the Buggy. Solder the plates, making sure to cover each of the eight contact points. Repeat steps 7 and 8 for the remaining two plates.

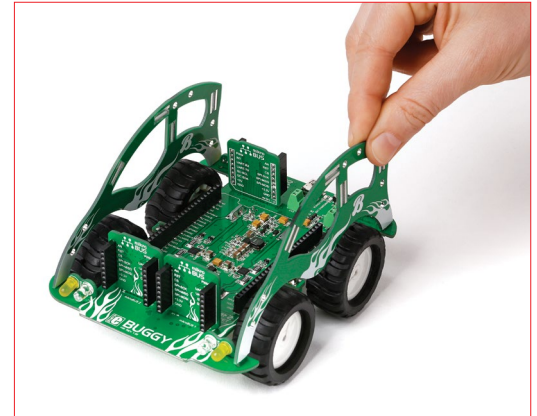

STEP 9 - Set side panels in place

Next, position the two side panels. You won't be soldering them yet, but pay attention to place the panels in the correct direction: the lower part faces forward, where the white and yellow LEDs are.

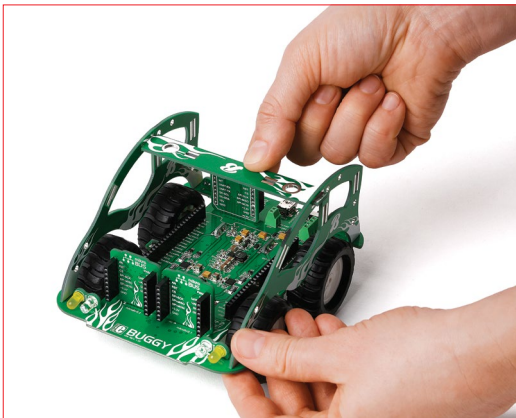

STEP 10 - Attach top bar

The top bar connects the two side panels and keeps the Buggy rigid, while also providing slots for soldering additional electronics. Notice that each side panel has four different slots for placing the top bar. You can use whichever one suits you best.



STEP 11 - Solder top bar

Solder the top bar to each side panel. You can always unsolder it later if you'd like to to change its position.



STEP 12 - Solder side panels

With the top bar soldered, flip the Buggy. Solder the two side panels to the main board; there are two contact points for each panel, one in each corner of the main board. Now flip the Buggy back on its wheels. You're done assembling!

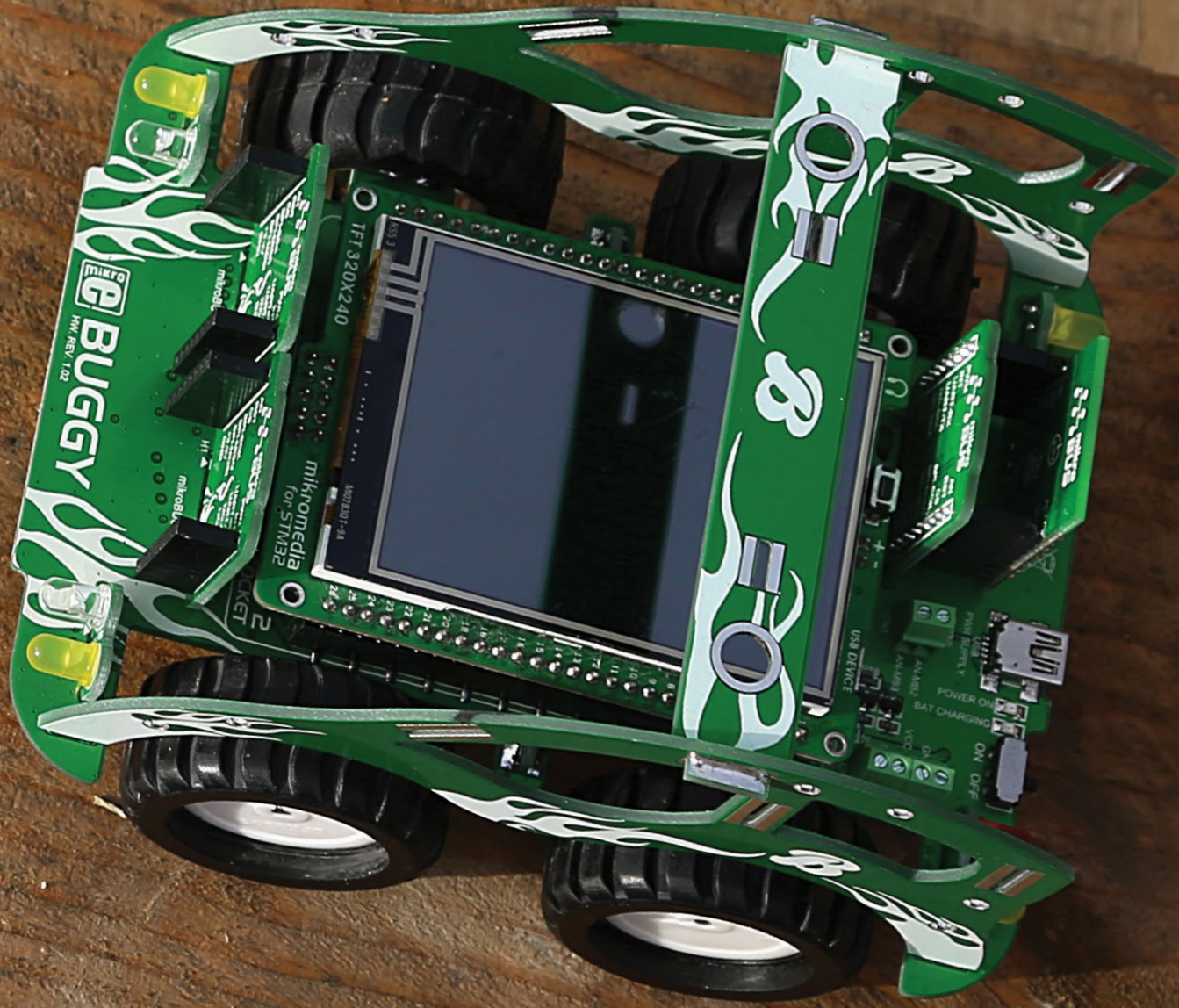

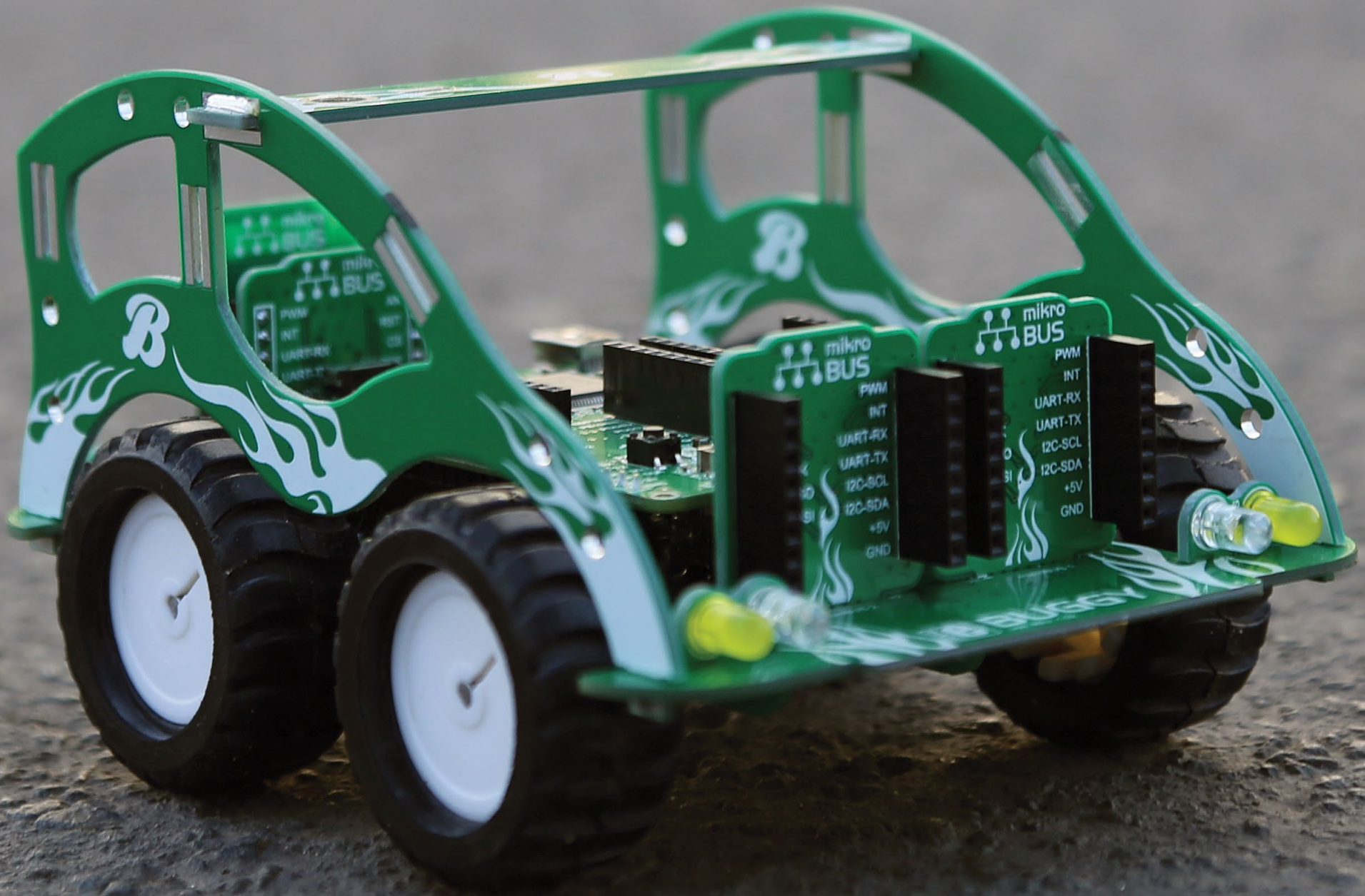

BUGGY

A motorized development platform

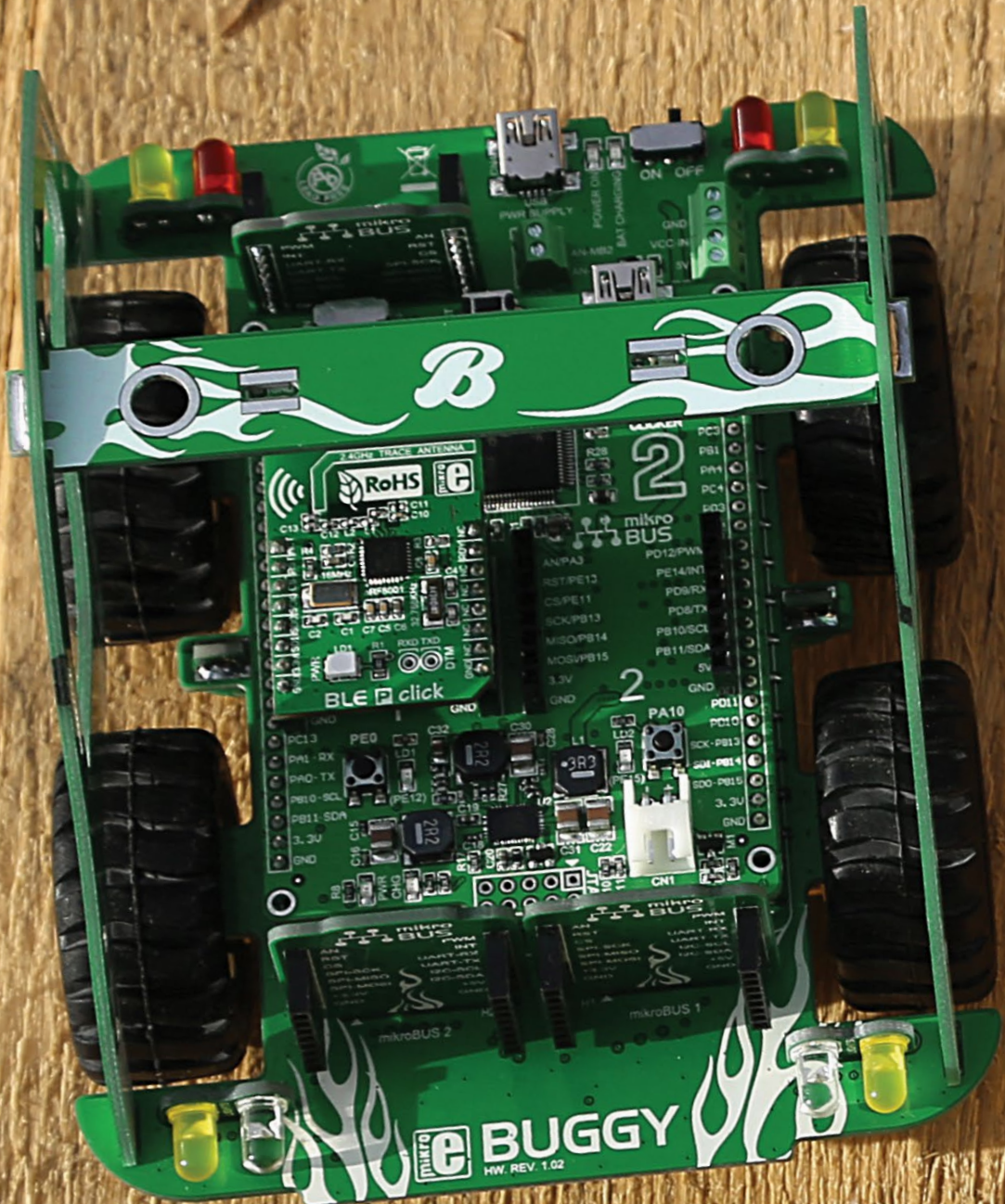

Choose your driver

Now that you've assembled the Buggy, the only remaining thing is to put a microcontroller in the driver's seat. You have two types of choices: (1) clicker 2 is a compact development platform with a MCU and two mikroBUS™ sockets (2) mikromedia is a multimedia development system with a 320x240 TFT touchscreen and a rich set of onboard modules. Both of these boards are available for different microcontroller architectures.

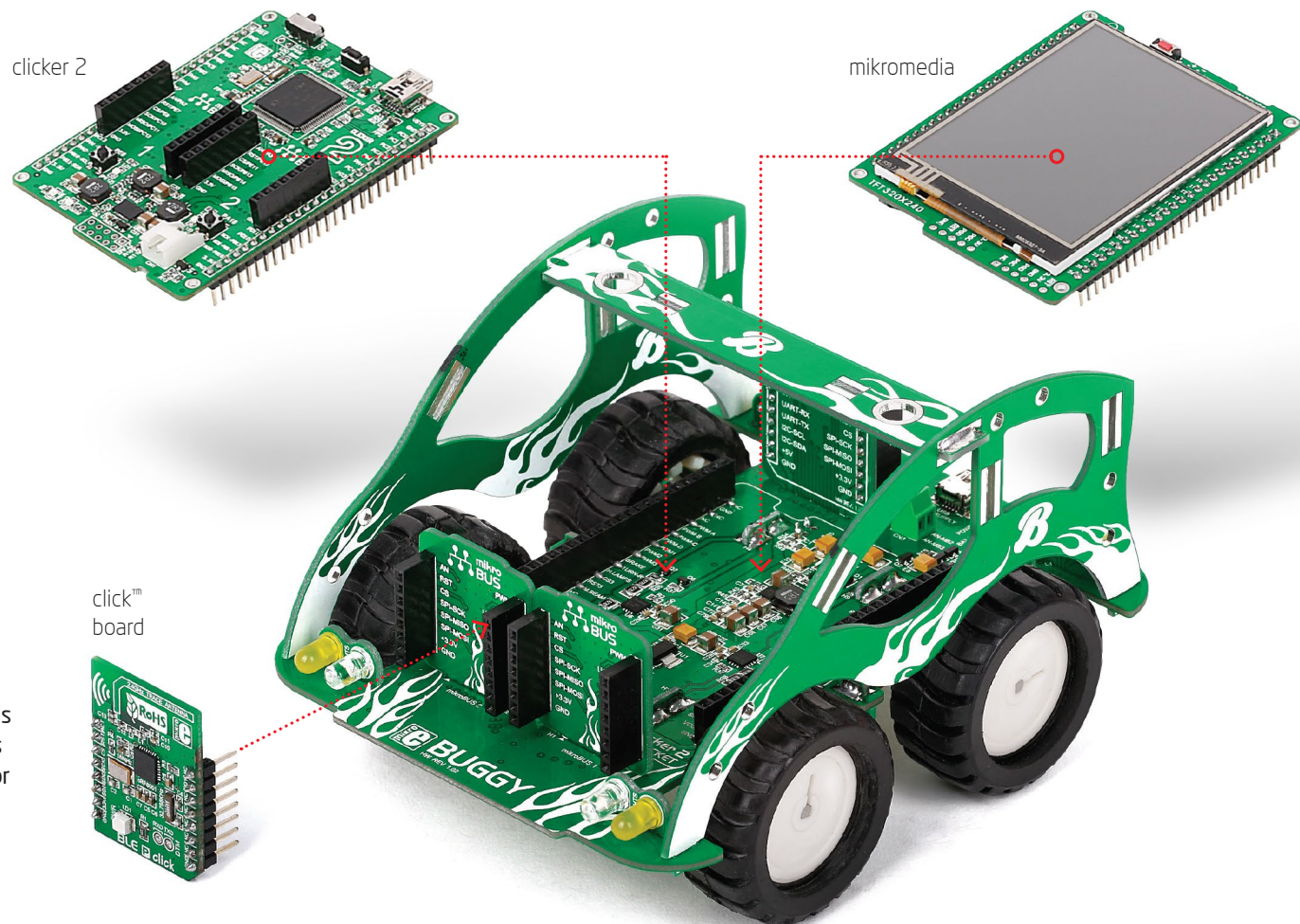

If you want to remotely control your Buggy, you'll also need a communications click™ board with a wireless transceiver module (Wi-Fi or Bluetooth work well).



clicker 2 & mikromedia pinout

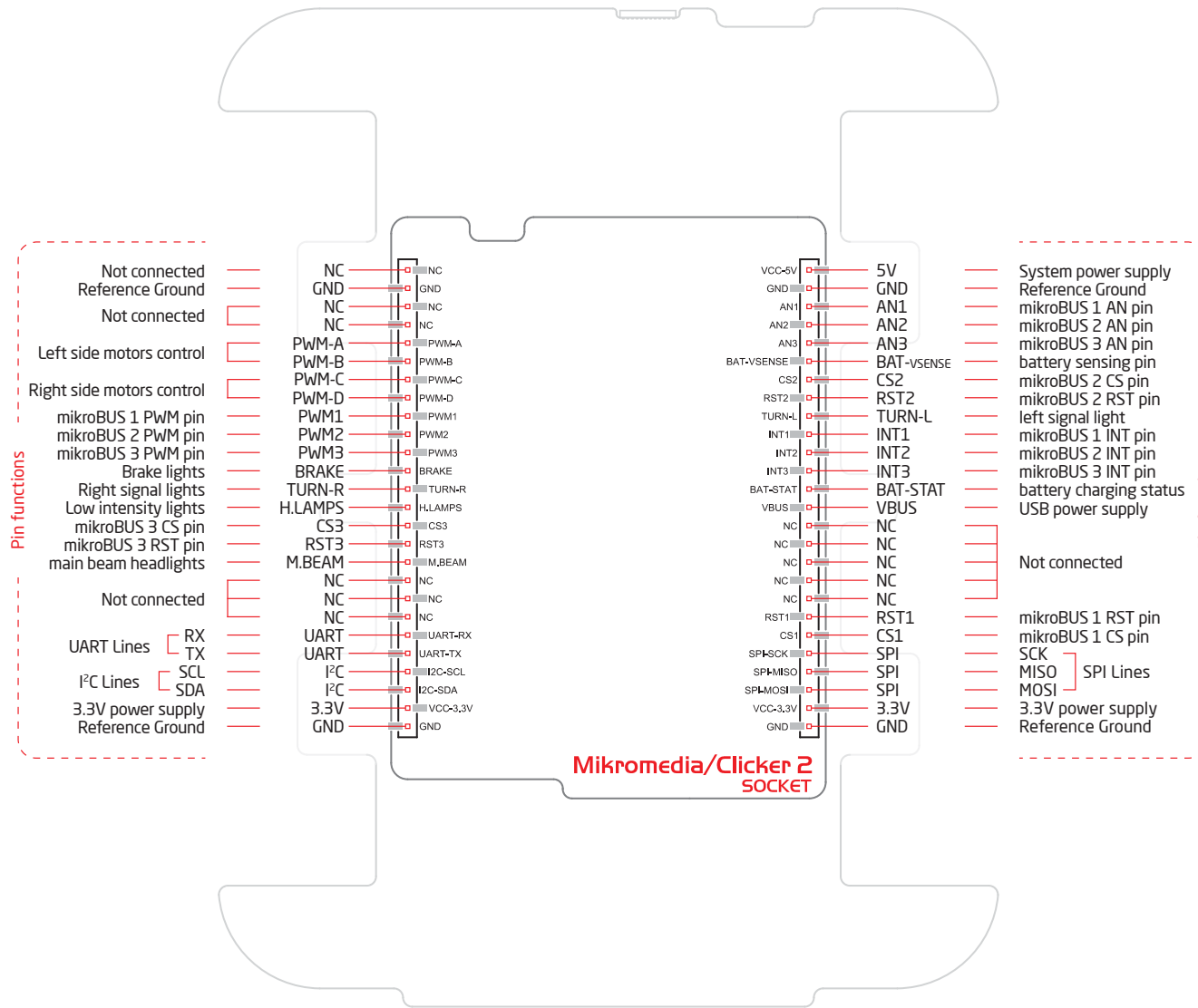

The Buggy carries a standard clicker 2/mikromedia pinout with a pair of 1x26 connection pads. However, to make the Buggy easier to program, some of the pins have descriptive labels that point out their functions in relations to the motors, lights and so on.

clicker 2 – a click™ board two-seater

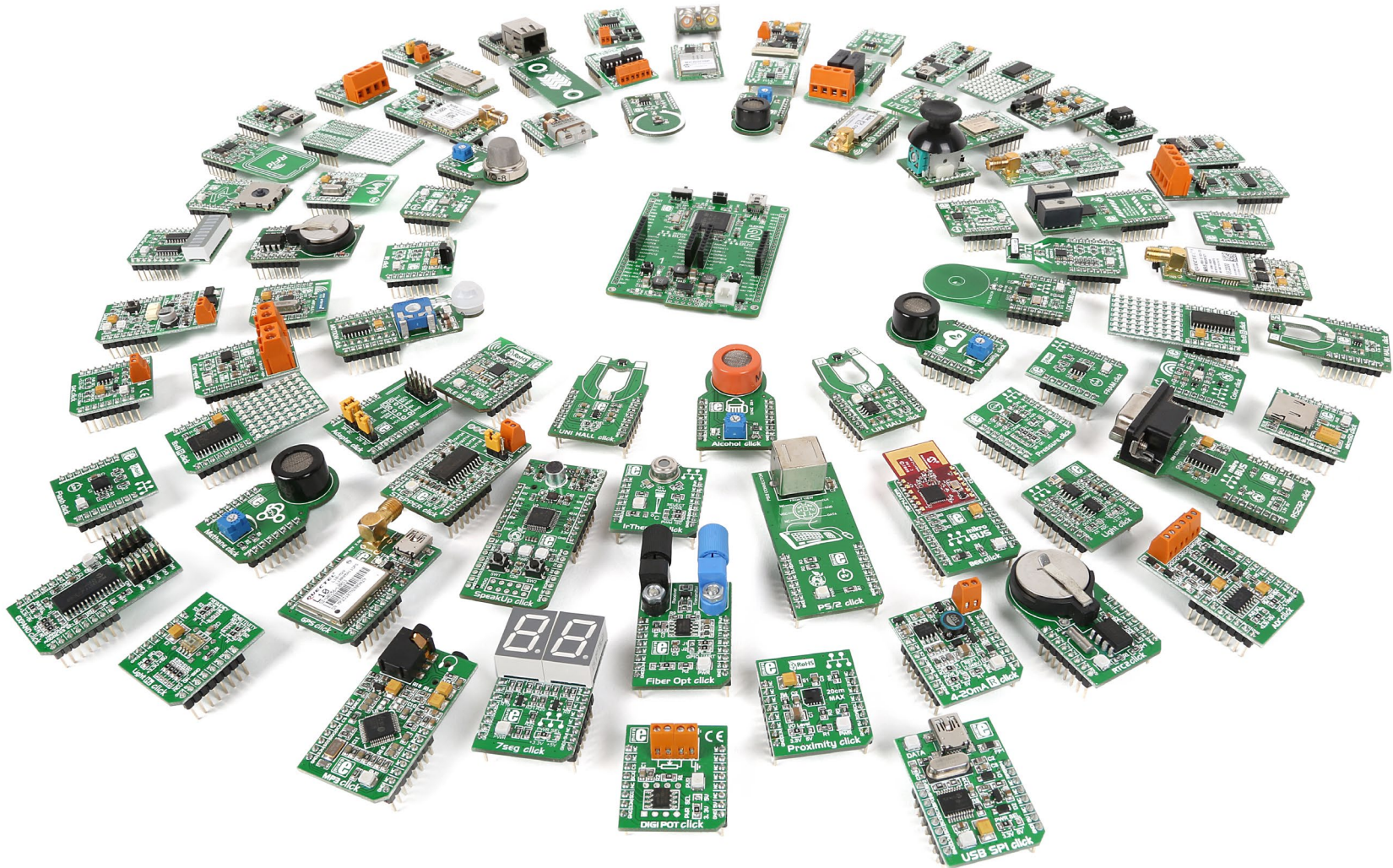

Available for several MCU architectures, clicker 2 is a compact development kit with two mikroBUS™ sockets for click™ board connectivity. You can use it to quickly build your own gadgets with unique functionalities and features. It's an ideal Buggy driver because it lets you leverage the huge potential of click™ boards, our constantly expanding range of over 100 add-on boards.

Lights



Just like a real car, the Buggy has a set of front and rear lights for signaling and for lighting the way. These lights are routed in a way that makes them easier to program should you develop your own firmware for the Buggy. They're grouped in three sets based on function: (1) The pair of white LEDs on the front are headlights, with two modes of brightness; (2) The red LED brake lights on the rear also have two brightness levels; and (3) the two pair of yellow LED signal lights are grouped by left and right side.

Highlighted above are the five pins that control the lights. TURN L and TURN R regulate the signal lights. H.LAMPS turns on the headlights and rear lights at low intensity. Activate both the M.BEAM and

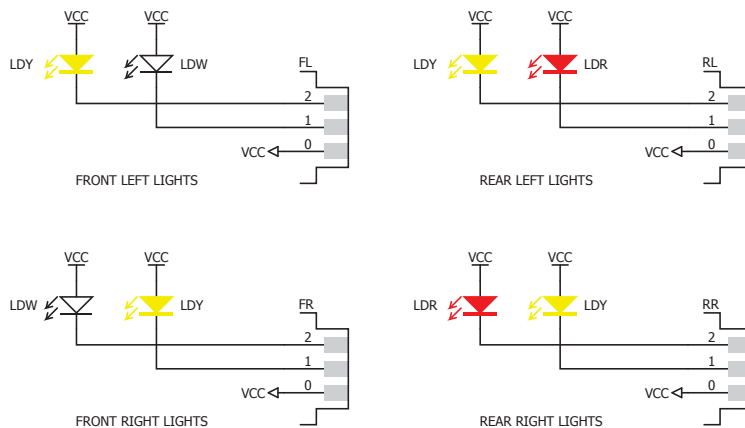

LED schematics

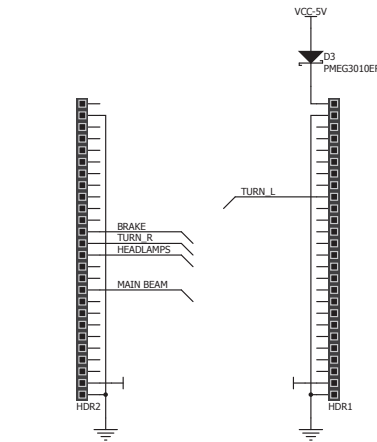

Pins for controlling Buggy's light

H.LAMPS at the same time for brighter headlights. For brighter rear lights (stop lights), activate the BRAKE and H.LAMPS at the same time.

Motors

The Buggy has a differential motor drive. The four DC motors are split by left and right axis (controlled by **DRV8333RTY** motor drivers, **U6** and **U7**, one for each side). Steering takes place when you vary the relative rate of rotation between the left and right side. This type of steering is simpler to manipulate if you'll be writing your own firmware for the Buggy. Also, when one pair of wheels is put in reverse while the other is in normal gear, the Buggy will start to spin, which wouldn't be possible otherwise.

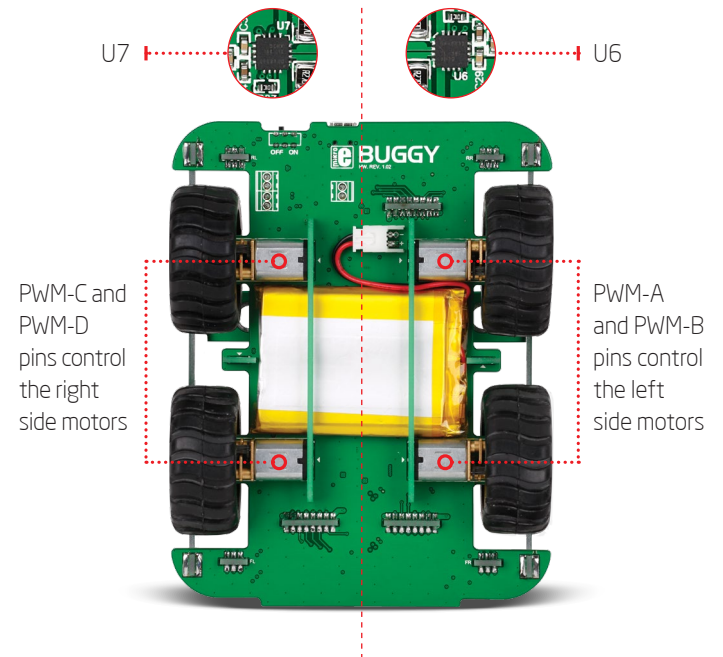

To prevent the motors from drawing too much current from the battery (and in doing so prevent the other components from functioning properly) a few resistors are placed to limit current draw. Each motor can draw a maximum of 400 mA, for a total of 1.6 A for all four motors.

Power supply

Battery charger

The Buggy runs on a 3.7V 2000mA battery. Once you install the battery, there's no need to take it out; charge it through the Buggy's USB port. A miniature single-cell, fully integrated Li-Ion, Li-Polymer charge management controller, **MCP73832** enables that. A red power indication LED will signalize when the battery is charging. Once charged, it'll turn off.

Screw terminals

The Buggy's expandability is not limited to mikroBUS™ sockets and click™ boards. You can attach a variety of sensors and antennas to its top bar. A pair of screw terminals will allow you to connect those additional components to the main power supply. Both 3.3V and 5V outputs are available. There's an additional pair of screw terminals that are analog inputs.

ON/OFF switch

The ON/OFF switch on the rear of the Buggy, between the USB port and the left rear lights, controls the main power supply. A clicker 2 board also has its own ON/OFF switch, which should be kept in the ON position in order for the main power supply switch to work. A green LED will indicate the presence of a power supply. When removing the clicker 2, keep both switches OFF.

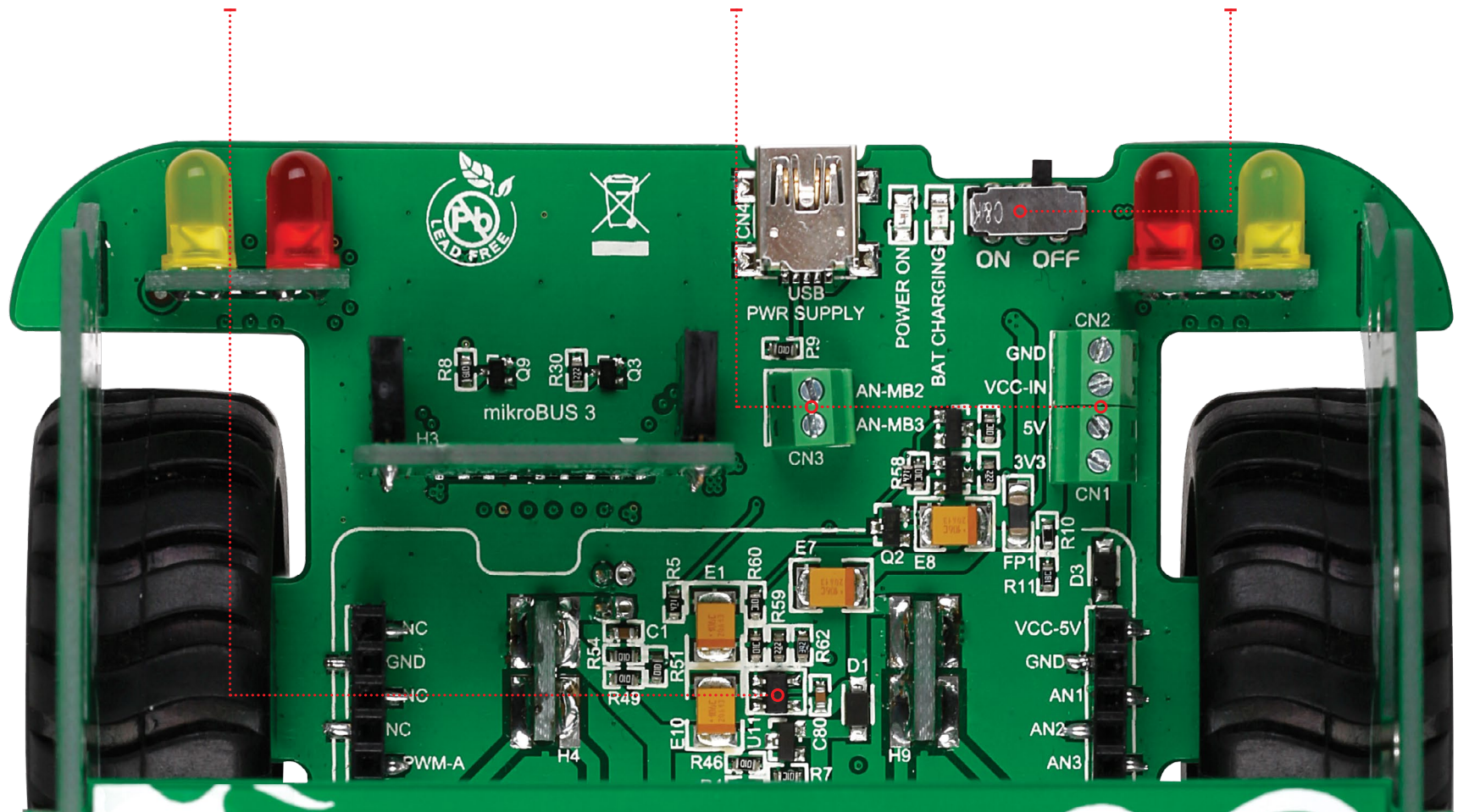

mikroBUS™ sockets



Enhancing the Buggy with various sensors and communication modules is easy – you just plug a MikroElektronika click™ board into one of the 3+2 available mikroBUS™ sockets and you're good to go.

mikroBUS™ is a specially designed pinout standard with **SPI, I2C, Analog, UART, Interrupt, PWM, Reset and Power supply pins**. It has two 1x8 headers, each with VCC and GND power supply pads.

The Buggy comes with **three mikroBUS™ sockets, two in the front, one in the rear**. If you connect a clicker 2 board to the Buggy you'll get two more sockets for a total of five mikroBUS™ sockets.

There are **more than a 100 click™ boards available**. Each click™ board comes with a single module, and these vary from sensors to displays, audio to motor control, communication to fiber optics, even speech recognition.

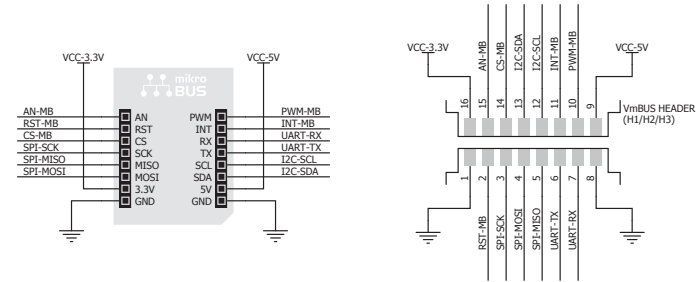

Vertical mikroBUS™ socket schematic

Learn more about the mikroBUS™ standard at www.mikroe.com/mikrobus

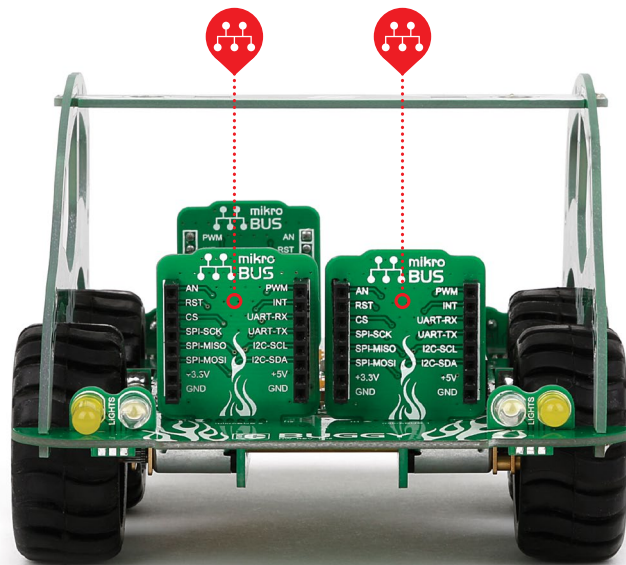

Front mikroBUS™ plates



Rear mikroBUS™ plate

click™ boards are plug-and-play!

For a few years now, MikroElektronika has been expanding their range of click™ boards. Almost **each month several new click™ boards** are released, carrying all types of **sensors and communication modules**. There are over a 100 click™ boards to choose from. You'll be able to **expand your Buggy with additional functionality** with literally zero hardware configuration. Just plug and play.

For the complete list of available click™ boards, please visit:



www.mikroe.com/click

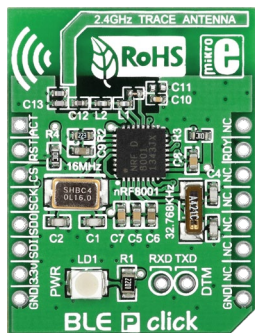

BLE P click™



BlueTooth click™



GPS click™



WiFi PLUS click™



GSM click™

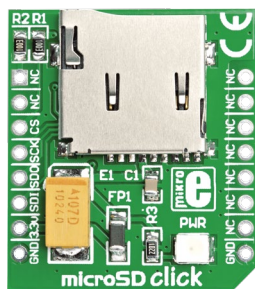

microSD click™

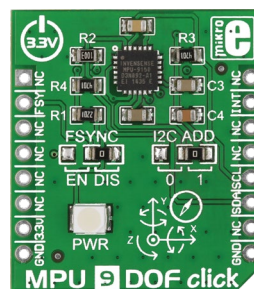

MPU 9DOF click™



nRF C click™

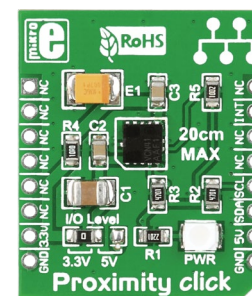

Proximity click™

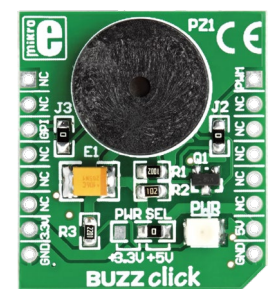

BUZZ click™



Firmware



If your clicker 2 board came with the Buggy as part of a kit, then you're all set – the firmware compatible with the Android app shown on the right is already installed.

If you've purchased only the Buggy by itself, no problem. Clicker 2 and mikromedia boards have a USB-HID bootloader which makes it easy to install the firmware. All you have to do is download the mikroBootloader application for your clicker 2 or mikromedia board, along with the firmware, all available from www.mikroe.com/buggy.



mikrobootloader application

Then turn off the Buggy, detach the clicker 2 board, plug it to your computer via USB, and follow the simple 4-step procedure in mikroBootloader.

If you're making your own custom firmware for the Buggy in mikroC™, mikroBasic™ or mikroPascal™, you'll also upload it with the mikroBootloader.

Android application

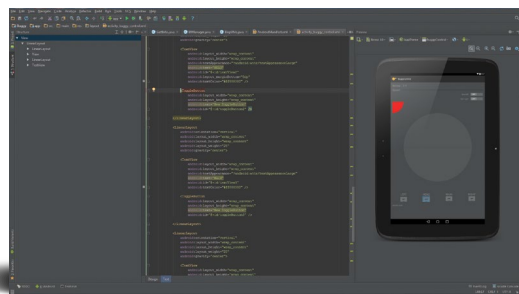

Edit the code for the Buggy App and make it your own – shown here is Android Studio, a popular Android platform IDE

A free open-source Android App for driving the Buggy is available from mikroe.com/buggy. The App talks to the Buggy through a wireless transceiver click™ board (Bluetooth or Wi-Fi). It's a great starting point to develop your own original applications for the Buggy, just open the project in your Android SDK of choice (for example Android Studio, shown here). But first, spend some time driving the Buggy around from your smartphone or tablet, just for fun.

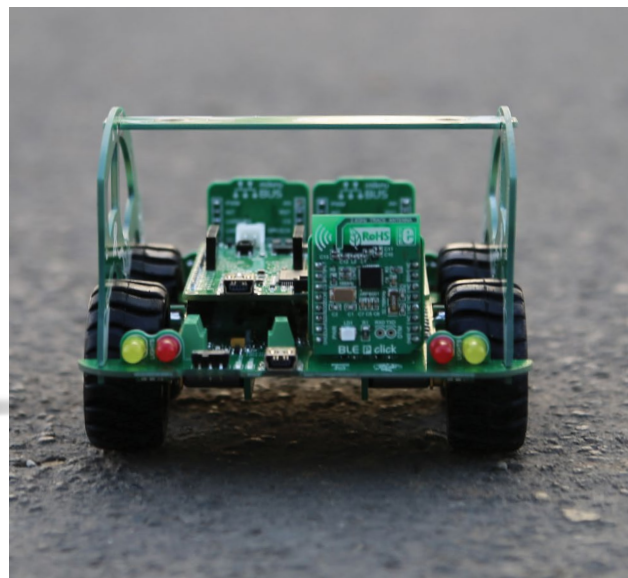

Install the app on your smartphone or tablet and take your Buggy to the road

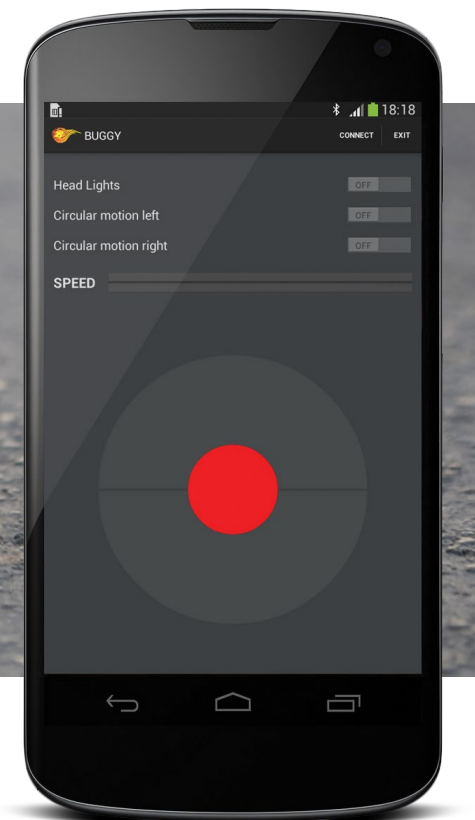

Schematic

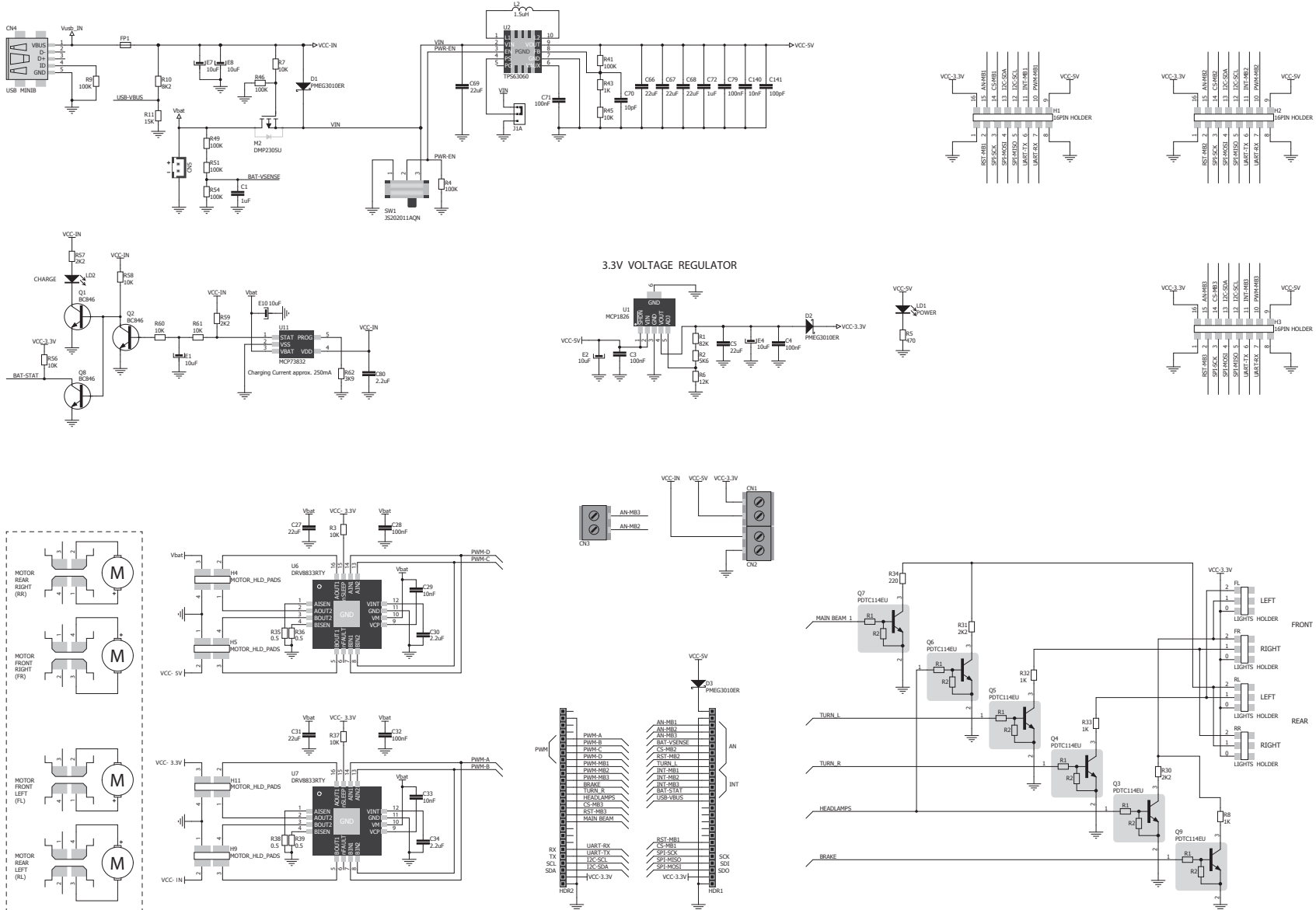

What's Next?



You have now completed the journey through each and every feature of the Buggy. You got to know its features, supported microcontrollers and other expandability options. Now you are ready to start building your own robotic vehicle. We are suggesting several steps which are probably the best way to begin. We invite you to join our community. You will find very useful projects and tutorials and can get help from a large ecosystem of users. Welcome!

1

Compilers

You still don't have an appropriate compiler? Locate the compiler that suits you best on our website (see link below).

Choose between **mikroC™**, **mikroBasic™** and **mikroPascal™**, and download a fully functional demo version, so you can begin building your applications.



www.mikroe.com/compilers

2

Community

If you want to find answers to your questions on many interesting topics we invite you to visit our forum at **www.mikroe.com/forum** and browse through more than 150 thousand posts. You are likely to find just the right information. On the other hand, if you want to download free projects and libraries, or share your own code, please visit the **Libstock™ website**. With user profiles, you can get to know other programmers, and subscribe to receive notifications on their code.



www.libstock.com

3

Support

We all know how important it is to be able to rely on someone in moments when we are stuck with our projects, facing a deadline, or when we just want to ask a simple, basic question that's pulling us back for a while. We do understand how important this is to people; our Support Department is one of the pillars upon which our company is based. MikroElektronika offers **Free Tech Support** to the end of product lifetime, so if something goes wrong, we are ready and willing to help!



www.mikroe.com/support

DISCLAIMER

All the products owned by MikroElektronika are protected by copyright law and international copyright treaty. Therefore, this manual is to be treated as any other copyright material. No part of this manual, including product and software described herein, may be reproduced, stored in a retrieval system, translated or transmitted in any form or by any means, without the prior written permission of MikroElektronika. The manual PDF edition can be printed for private or local use, but not for distribution. Any modification of this manual is prohibited.

MikroElektronika provides this manual 'as is' without warranty of any kind, either expressed or implied, including, but not limited to, the implied warranties or conditions of merchantability or fitness for a particular purpose.

MikroElektronika shall assume no responsibility or liability for any errors, omissions and inaccuracies that may appear in this manual. In no event shall MikroElektronika, its directors, officers, employees or distributors be liable for any indirect, specific, incidental or consequential damages (including damages for loss of business profits and business information, business interruption or any other pecuniary loss) arising out of the use of this manual or product, even if MikroElektronika has been advised of the possibility of such damages. MikroElektronika reserves the right to change information contained in this manual at any time without prior notice, if necessary.

HIGH RISK ACTIVITIES

The products of MikroElektronika are not fault - tolerant nor designed, manufactured or intended for use or resale as on - line control equipment in hazardous environments requiring fail - safe performance, such as in the operation of nuclear facilities, aircraft navigation or communication systems, air traffic control, direct life support machines or weapons systems in which the failure of Software could lead directly to death, personal injury or severe physical or environmental damage ('High Risk Activities'). MikroElektronika and its suppliers specifically disclaim any expressed or implied warranty of fitness for High Risk Activities.

TRADEMARKS

The MikroElektronika name and logo, mikroC™, mikroBasic™, mikroPascal™, Visual TFT™, Visual GLCD™, mikroProg™, Ready™, MINI™, mikroBUS™, EasyPIC™, EasyAVR™, Easy8051™, click™ boards and mikromedia™ are trademarks of MikroElektronika. All other trademarks mentioned herein are property of their respective companies. All other product and corporate names appearing in this manual may or may not be registered trademarks or copyrights of their respective companies, and are only used for identification or explanation and to the owners' benefit, with no intent to infringe.

Copyright © 2015 MikroElektronika. All Rights Reserved.

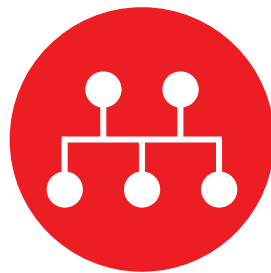

If you want to learn more about our products, please visit our website at **www.mikroe.com**

If you are experiencing some problems with any of our products or just need additional information, please place your ticket at **www.mikroe.com/support**

If you have any questions, comments or business proposals,
do not hesitate to contact us at **office@mikroe.com**

