

SiGe High-Linearity, 815MHz to 1000MHz Downconversion Mixer with LO Buffer/Switch

General Description

The MAX9986A high-linearity downconversion mixer provides 8.2dB gain, +25dBm IIP3, and 10dB NF for 815MHz to 1000MHz base-station receiver applications. With a 960MHz to 1180MHz LO frequency range, this particular mixer is ideal for high-side LO injection receiver architectures. Low-side LO injection is supported by the MAX9984, which is pin-for-pin and functionally compatible with the MAX9986A.

In addition to offering excellent linearity and noise performance, the MAX9986A also yields a high level of component integration. This device includes a double-balanced passive mixer core, an IF amplifier, a dual-input LO selectable switch, and an LO buffer. On-chip baluns are also integrated to allow for single-ended RF and LO inputs. The MAX9986A requires a nominal LO drive of 0dBm, and supply current is guaranteed to be below 250mA.

The MAX9986A is a derivative version of the MAX9986 with improved large-signal blocking performance. The MAX9984/MAX9986/MAX9986A are pin compatible with the MAX9994/MAX9996 1700MHz to 3000MHz mixers, making this entire family of downconverters ideal for applications where a common PC board layout is used for both frequency bands. The MAX9986A is also functionally compatible with the MAX9993.

The MAX9986A is available in a compact, 20-pin, thin QFN package (5mm x 5mm) with an exposed paddle. Electrical performance is guaranteed over the extended -40°C to +85°C temperature range.

Applications

850MHz WCDMA Base Stations
GSM 850/GSM 900 2G and 2.5G EDGE Base Stations
cdmaOne™ and cdma2000® Base Stations
iDEN® Base Stations
Predistortion Receivers
Fixed Broadband Wireless Access
Wireless Local Loops
Private Mobile Radios
Military Systems
Microwave Links
Digital and Spread-Spectrum Communication Systems

cdma2000 is a registered trademark of the Telecommunications Industry Association.

cdmaOne is a trademark of CDMA Development Group.

iDEN is a registered trademark of Motorola, Inc.

MAXIM

Features

- ◆ 815MHz to 1000MHz RF Frequency Range
- ◆ 960MHz to 1180MHz LO Frequency Range (MAX9986A/MAX9986)
- ◆ 570MHz to 850MHz LO Frequency Range (MAX9984)
- ◆ 50MHz to 250MHz IF Frequency Range
- ◆ 8.2dB Conversion Gain
- ◆ +25dBm Input IP3
- ◆ +14.8dBm Input 1dB Compression Point
- ◆ 10dB Noise Figure
- ◆ 69dBc 2LO - 2RF Spurious Rejection at PRF = -10dBm
- ◆ Integrated LO Buffer
- ◆ Integrated RF and LO Baluns for Single-Ended Inputs
- ◆ Low -3dBm to +3dBm LO Drive
- ◆ Built-In SPDT LO Switch with 49dB LO1 to LO2 Isolation and 50ns Switching Time
- ◆ Pin Compatible with MAX9994/MAX9996 1700MHz to 3000MHz Mixers
- ◆ Functionally Compatible with MAX9993
- ◆ External Current-Setting Resistors Provide Option for Operating Mixer in Reduced Power/Reduced Performance Mode
- ◆ Lead-Free Package Available

Ordering Information

PART	TEMP RANGE	PIN-PACKAGE	PKG CODE
MAX9986AETP	-40°C to +85°C	20 Thin QFN-EP* 5mm x 5mm	T2055-3
MAX9986AETP-T	-40°C to +85°C	20 Thin QFN-EP* 5mm x 5mm	T2055-3
MAX9986AETP+	-40°C to +85°C	20 Thin QFN-EP* 5mm x 5mm	T2055-3
MAX9986AETP+T	-40°C to +85°C	20 Thin QFN-EP* 5mm x 5mm	T2055-3

*EP = Exposed paddle.

+ = Lead free.

T = Tape-and-reel.

Pin Configuration/Functional Diagram and Typical Application Circuit appear at end of data sheet.

MAX9986A

SiGe High-Linearity, 815MHz to 1000MHz Downconversion Mixer with LO Buffer/Switch

ABSOLUTE MAXIMUM RATINGS

V _{CC} to GND	-0.3V to +5.5V
IF+, IF-, LOBIAS, LOSEL, IFBIAS to GND.....	-0.3V to (V _{CC} + 0.3V)
TAP	-0.3V to +1.4V
LO1, LO2, LEXT to GND.....	-0.3V to +0.3V
RF, LO1, LO2 Input Power	+12dBm
RF (RF is DC shorted to GND through a balun)50mA
Continuous Power Dissipation (T _A = +70°C) 20-Pin Thin QFN-EP (derate 26.3mW/°C above +70°C).....	2.1W

θ _{JA}	+38°C/W
θ _{JC}	+13°C/W
Operating Temperature Range (Note A)	T _C = -40°C to +85°C
Junction Temperature	+150°C
Storage Temperature Range	-65°C to +150°C
Lead Temperature (soldering, 10s).....	+300°C

Note A: T_C is the temperature on the exposed paddle of the package.

Stresses beyond those listed under "Absolute Maximum Ratings" may cause permanent damage to the device. These are stress ratings only, and functional operation of the device at these or any other conditions beyond those indicated in the operational sections of the specifications is not implied. Exposure to absolute maximum rating conditions for extended periods may affect device reliability.

DC ELECTRICAL CHARACTERISTICS

(MAX9986A Typical Application Circuit, V_{CC} = +4.75V to +5.25V, no RF signal applied, IF+ and IF- outputs pulled up to V_{CC} through inductive chokes, R1 = 953Ω, R2 = 619Ω, T_C = -40°C to +85°C, unless otherwise noted. Typical values are at V_{CC} = +5V, T_C = +25°C, unless otherwise noted.)

PARAMETER	SYMBOL	CONDITIONS	MIN	TYP	MAX	UNITS
Supply Voltage	V _{CC}		4.75	5.00	5.25	V
Supply Current	I _{CC}			213	250	mA
LO_SEL Input-Logic Low	V _{IL}				0.8	V
LO_SEL Input-Logic High	V _{IH}		2			V

AC ELECTRICAL CHARACTERISTICS

(MAX9986A Typical Application Circuit, V_{CC} = +4.75V to +5.25V, RF and LO ports are driven from 50Ω sources, P_{LO} = -3dBm to +3dBm, P_{RF} = -5dBm, f_{RF} = 815MHz to 1000MHz, f_{LO} = 960MHz to 1180MHz, f_{IF} = 160MHz, f_{LO} > f_{RF}, T_C = -40°C to +85°C, unless otherwise noted. Typical values are at V_{CC} = +5V, P_{RF} = -5dBm, P_{LO} = 0dBm, f_{RF} = 910MHz, f_{LO} = 1070MHz, f_{IF} = 160MHz, T_C = +25°C, unless otherwise noted.) (Note 1)

PARAMETER	SYMBOL	CONDITIONS	MIN	TYP	MAX	UNITS
RF Frequency Range	f _{RF}	(Note 2)	815		1000	MHz
LO Frequency Range	f _{LO}	(Note 2)	960		1180	MHz
		MAX9984	570		850	
IF Frequency Range	f _{IF}	(Note 2)	50		250	MHz
Conversion Gain	G _C	T _C = +25°C	7.2	8.2	9.3	dB
Gain Variation Over Temperature		T _C = -40°C to +85°C		-0.009		dB/°C
Conversion Gain Flatness		Flatness over any one of three frequency bands: f _{RF} = 824MHz to 849MHz f _{RF} = 869MHz to 894MHz f _{RF} = 880MHz to 915MHz		±0.15		dB
Input Compression Point	P _{1dB}	(Note 3)		14.8		dBm
Input Third-Order Intercept Point	IIP3	Two tones: f _{RF1} = 910MHz, f _{RF2} = 911MHz, P _{RF} = -5dBm/tone, f _{LO} = 1070MHz, P _{LO} = 0dBm, T _A = +25°C	22	25		dBm
Input IP3 Variation Over Temperature		T _C = +25°C to -40°C		-1.8		dB
		T _C = +25°C to +85°C		+0.7		

SiGe High-Linearity, 815MHz to 1000MHz Downconversion Mixer with LO Buffer/Switch

MAX9986A

AC ELECTRICAL CHARACTERISTICS (continued)

(MAX9986A *Typical Application Circuit*, $V_{CC} = +4.75V$ to $+5.25V$, RF and LO ports are driven from 50Ω sources, $P_{LO} = -3dBm$ to $+3dBm$, $P_{RF} = -5dBm$, $f_{RF} = 815MHz$ to $1000MHz$, $f_{LO} = 960MHz$ to $1180MHz$, $f_{IF} = 160MHz$, $f_{LO} > f_{RF}$, $T_C = -40^\circ C$ to $+85^\circ C$, unless otherwise noted. Typical values are at $V_{CC} = +5V$, $P_{RF} = -5dBm$, $P_{LO} = 0dBm$, $f_{RF} = 910MHz$, $f_{LO} = 1070MHz$, $f_{IF} = 160MHz$, $T_C = +25^\circ C$, unless otherwise noted.) (Note 1)

PARAMETER	SYMBOL	CONDITIONS		MIN	TYP	MAX	UNITS
Noise Figure	NF	Single sideband, $f_{IF} = 190MHz$			10		dB
Noise Figure Under-Blocking		$f_{RF} = 900MHz$ (no signal) $f_{LO} = 1090MHz$ $f_{BLOCKER} = 981MHz$ $f_{IF} = 190MHz$ (Note 4)	$P_{BLOCKER} = +8dBm$		20		dB
			$P_{BLOCKER} = +11dBm$			23	
Small-Signal Compression Under-Blocking Condition		$P_{FUNDAMENTAL} = -5dBm$ $f_{FUNDAMENTAL} = 910MHz$ $f_{BLOCKER} = 911MHz$	$P_{BLOCKER} = +8dBm$		0.18		dB
			$P_{BLOCKER} = +11dBm$			0.4	
LO Drive				-3		+3	dBm
Spurious Response at IF	2 x 2	2LO - 2RF	$P_{RF} = -10dBm$		69		dBc
			$P_{RF} = -5dBm$		64		
	3 x 3	3LO - 3RF	$P_{RF} = -10dBm$		88		
			$P_{RF} = -5dBm$		78		
LO1-to-LO2 Isolation		$P_{LO} = +3dBm$ $T_C = +25^\circ C$ (Note 5)	LO2 selected	42	49		dB
			LO1 selected	42	50		
LO Leakage at RF Port		$P_{LO} = +3dBm$			-45		dBm
LO Leakage at IF Port		$P_{LO} = +3dBm$			-33		dBm
RF-to-IF Isolation					54		dB
LO Switching Time		50% of LOSEL to IF settled to within 2°			50		ns
RF Port Return Loss					20		dB
LO Port Return Loss		LO1/2 port selected, LO2/1 and IF terminated			22		dB
		LO1/2 port unselected, LO2/1 and IF terminated			34		
IF Port Return Loss		LO driven at $0dBm$, RF terminated into 50Ω , differential 200Ω			22		dB

Note 1: All limits include external component losses. Output measurements taken at IF output of the *Typical Application Circuit*.

Note 2: Operation outside this range is possible, but with degraded performance of some parameters.

Note 3: Compression point characterized. It is advisable not to operate continuously the mixer RF input above $+12dBm$.

Note 4: Measured with external LO source noise filtered so the noise floor is $-174dBm/Hz$. This specification reflects the effects of all SNR degradations in the mixer, including the LO noise as defined in *Maxim Application Note 2021*.

Note 5: Guaranteed by design and characterization.

SiGe High-Linearity, 815MHz to 1000MHz Downconversion Mixer with LO Buffer/Switch

Typical Operating Characteristics

(MAX9986A Typical Application Circuit, $V_{CC} = +5.0V$, $P_{LO} = 0dBm$, $P_{RF} = -5dBm$, $f_{LO} > f_{RF}$, $f_{IF} = 160MHz$, unless otherwise noted.)

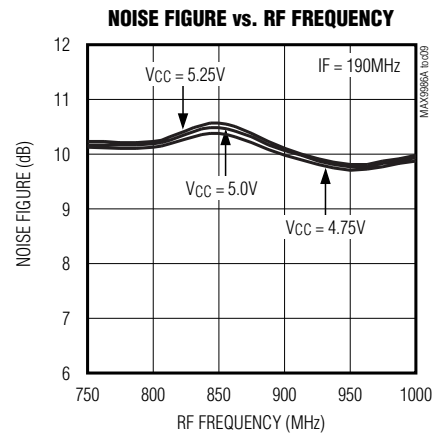
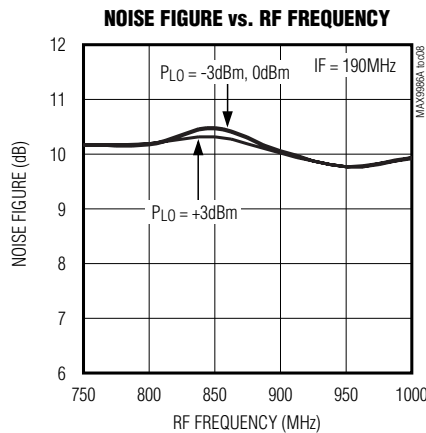
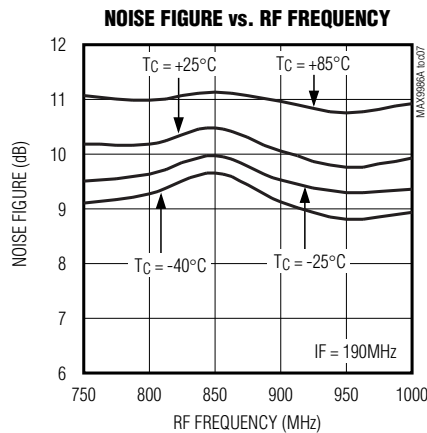
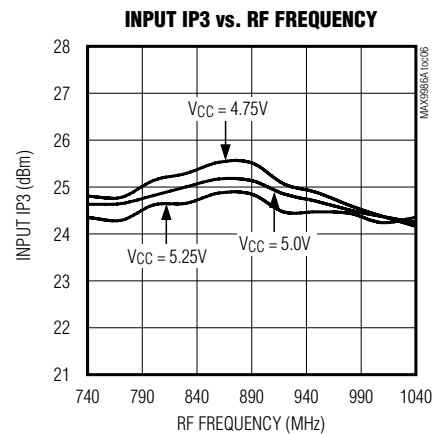
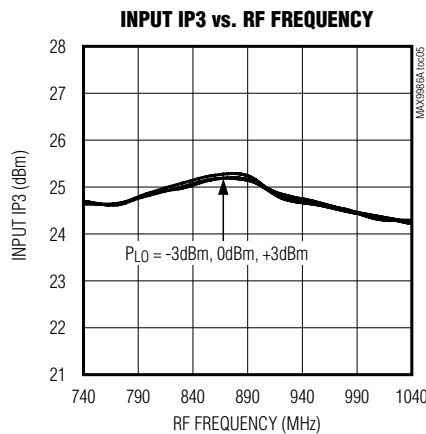
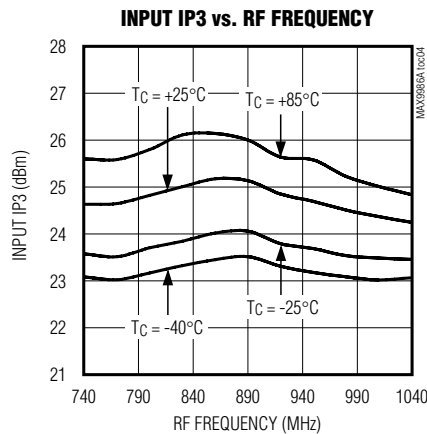
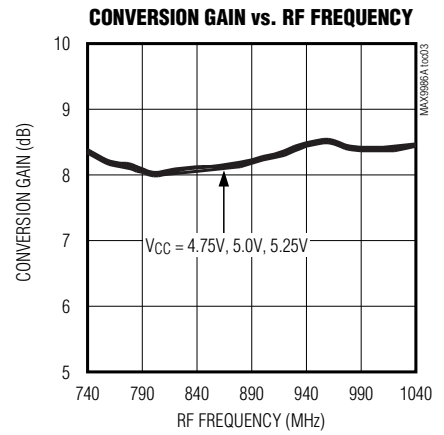
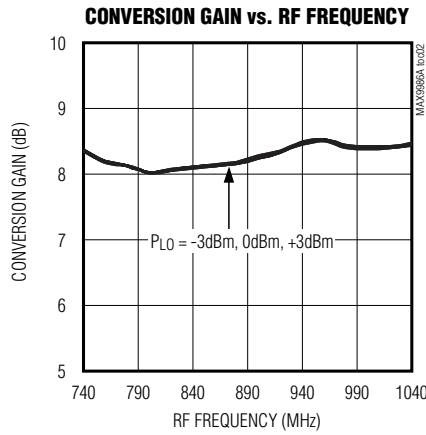
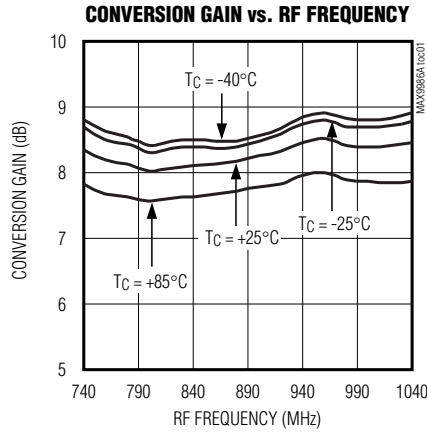

SiGe High-Linearity, 815MHz to 1000MHz Downconversion Mixer with LO Buffer/Switch

Typical Operating Characteristics (continued)

(MAX9986A Typical Application Circuit, $V_{CC} = +5.0V$, $P_{LO} = 0dBm$, $P_{RF} = -5dBm$, $f_{LO} > f_{RF}$, $f_{IF} = 160MHz$, unless otherwise noted.)

MAX9986A

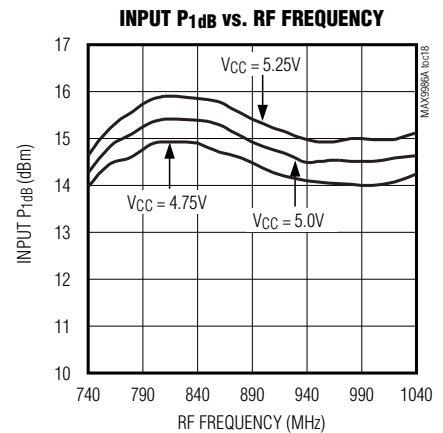
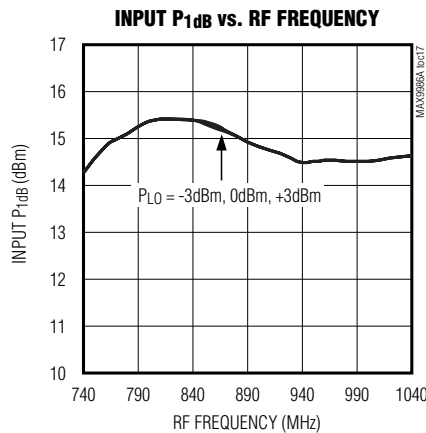
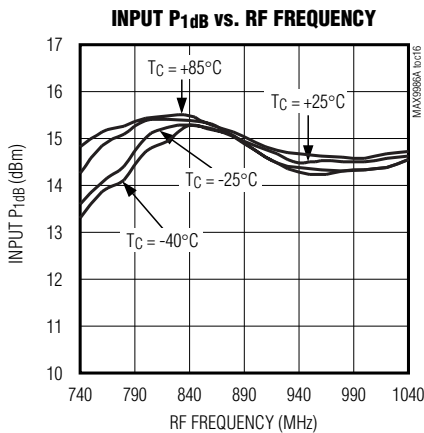
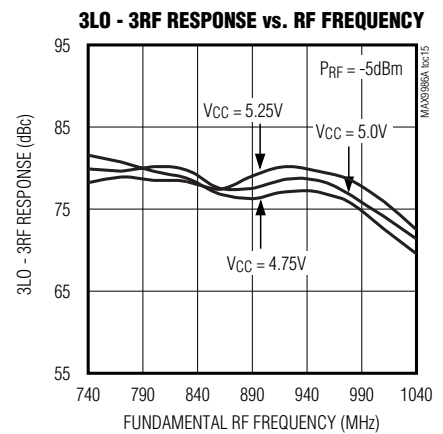
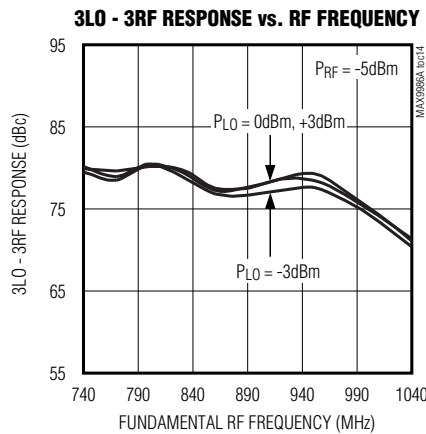
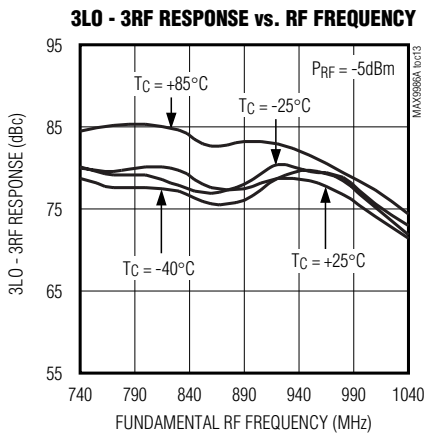
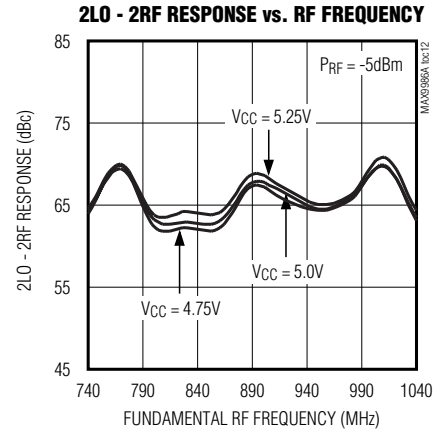
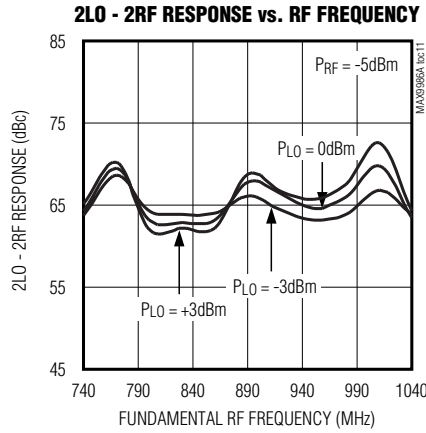
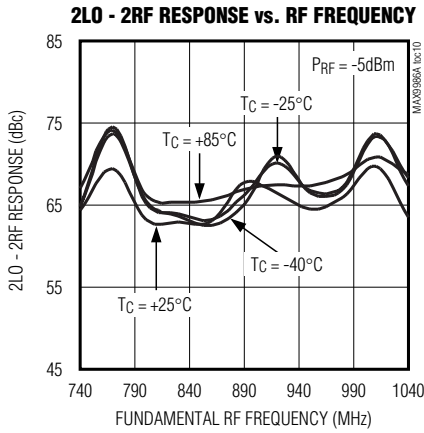

SiGe High-Linearity, 815MHz to 1000MHz Downconversion Mixer with LO Buffer/Switch

Typical Operating Characteristics (continued)

(MAX9986A Typical Application Circuit, $V_{CC} = +5.0V$, $P_{LO} = 0dBm$, $P_{RF} = -5dBm$, $f_{LO} > f_{RF}$, $f_{IF} = 160MHz$, unless otherwise noted.)

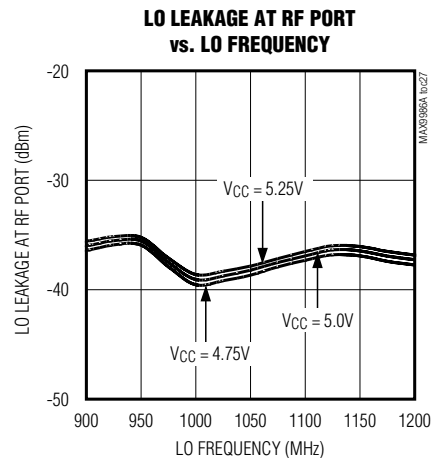
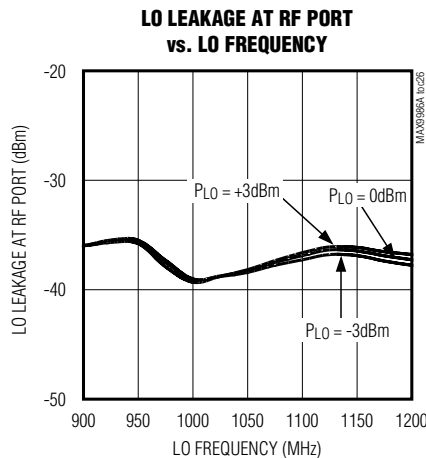
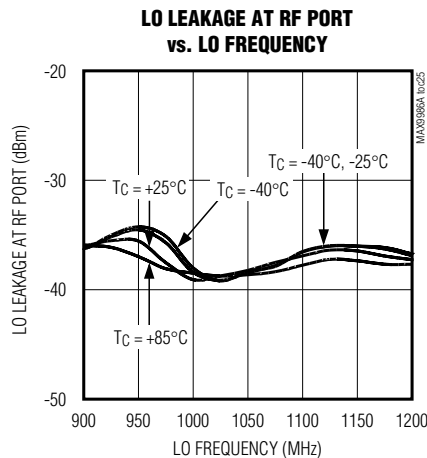
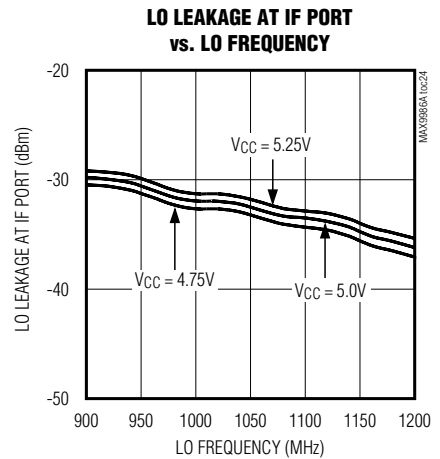
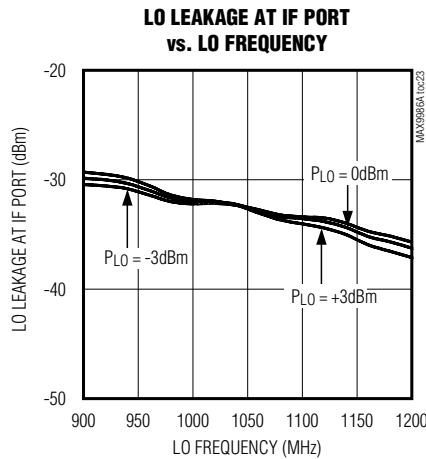
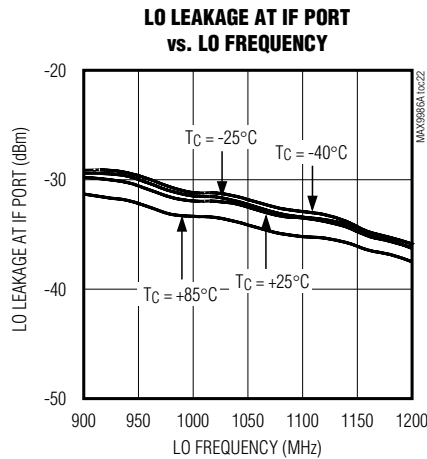
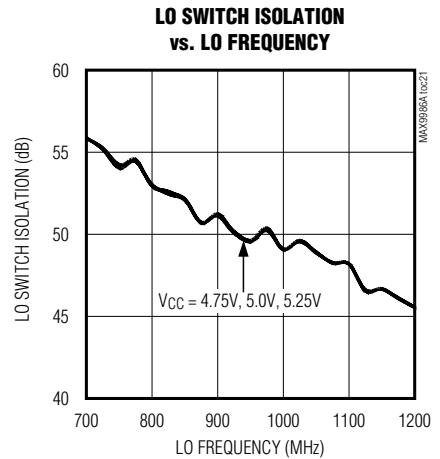
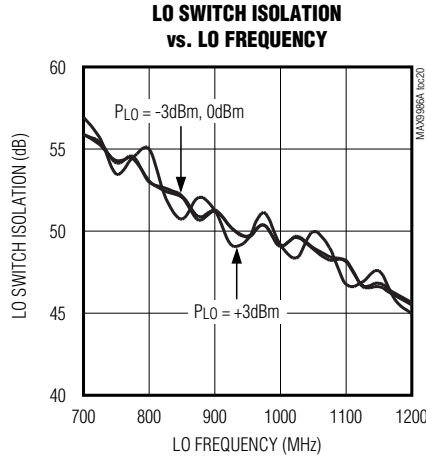
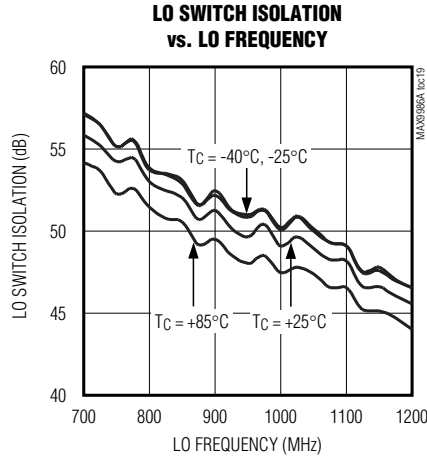

SiGe High-Linearity, 815MHz to 1000MHz Downconversion Mixer with LO Buffer/Switch

Typical Operating Characteristics (continued)

(MAX9986A Typical Application Circuit, $V_{CC} = +5.0V$, $P_{LO} = 0dBm$, $P_{RF} = -5dBm$, $f_{LO} > f_{RF}$, $f_{IF} = 160MHz$, unless otherwise noted.)

MAX9986A

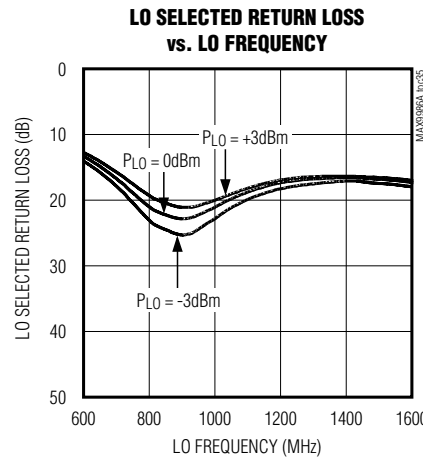
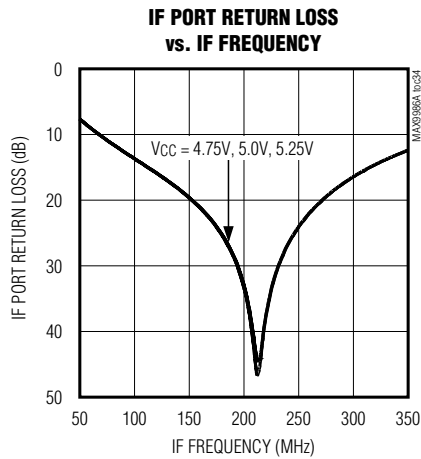
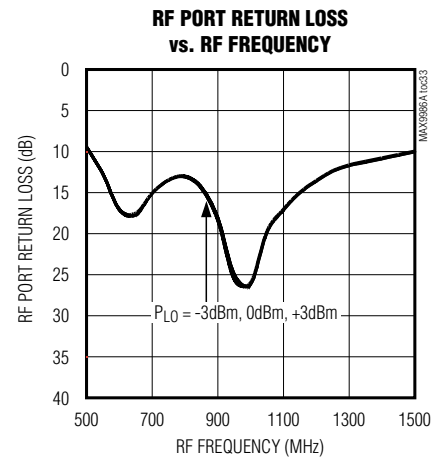
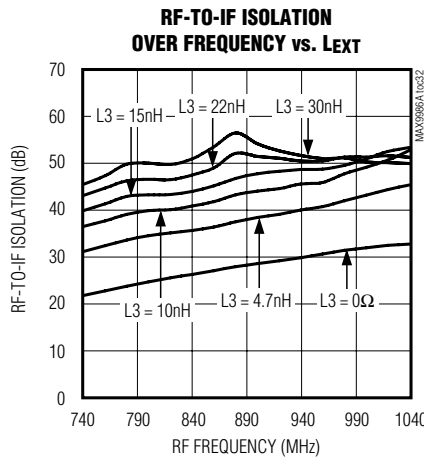
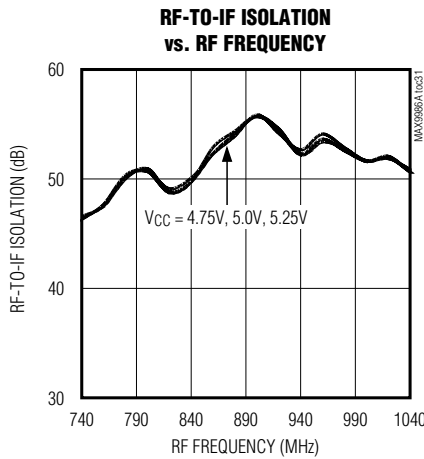
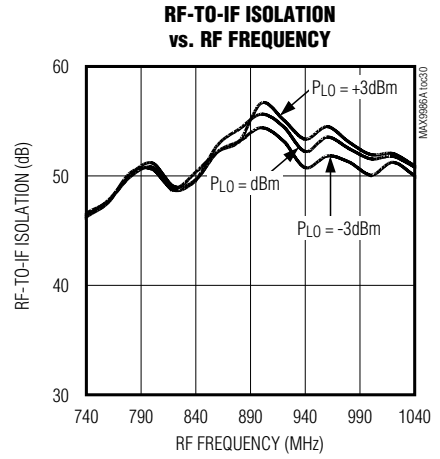
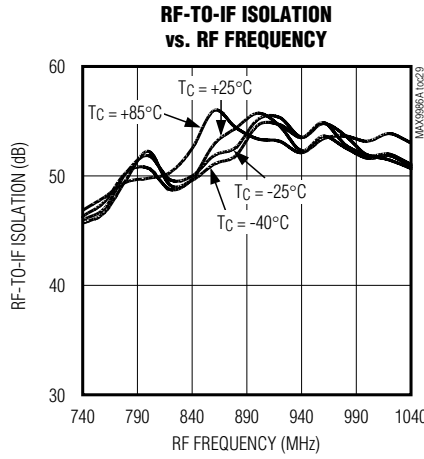
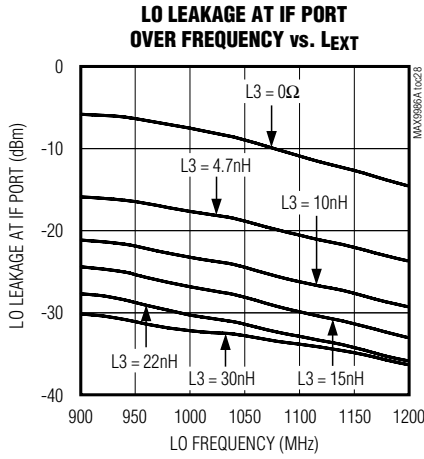

SiGe High-Linearity, 815MHz to 1000MHz Downconversion Mixer with LO Buffer/Switch

Typical Operating Characteristics (continued)

(MAX9986A Typical Application Circuit, $V_{CC} = +5.0V$, $P_{LO} = 0dBm$, $P_{RF} = -5dBm$, $f_{LO} > f_{RF}$, $f_{IF} = 160MHz$, unless otherwise noted.)

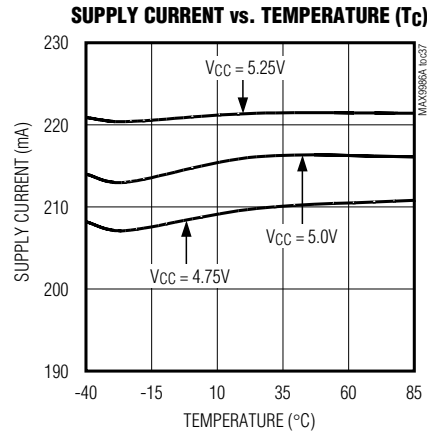
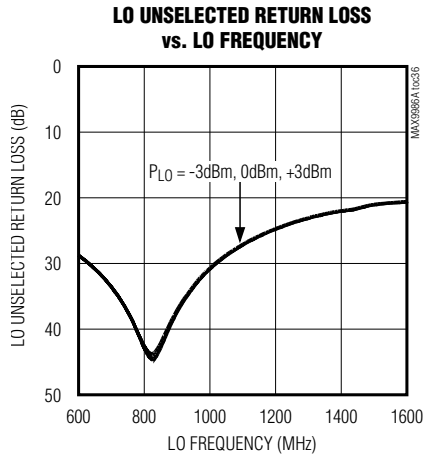

Pin Description

PIN	NAME	FUNCTION
1, 6, 8, 14	V _{CC}	Power-Supply Connection. Bypass each V _{CC} pin to GND with capacitors as shown in the <i>Typical Application Circuit</i> .
2	RF	Single-Ended 50Ω RF Input. This port is internally matched and DC shorted to GND through a balun. Requires an external DC-blocking capacitor.
3	TAP	Center Tap of the Internal RF Balun. Bypass to GND with capacitors close to the IC, as shown in the <i>Typical Application Circuit</i> .
4, 5, 10, 12, 13, 17	GND	Ground
7	LOBIAS	Bias Resistor for Internal LO Buffer. Connect a 619Ω ±1% resistor from LOBIAS to the power supply.
9	LOSEL	Local Oscillator Select. Logic control input for selecting LO1 or LO2.
11	LO1	Local Oscillator Input 1. Drive LOSEL low to select LO1.
15	LO2	Local Oscillator Input 2. Drive LOSEL high to select LO2.
16	LEXT	External Inductor Connection. Short LEXT to ground using a 0Ω resistor. For applications requiring improved RF-to-IF and LO-to-IF isolation, connect a low-ESR inductor from LEXT to GND. See the <i>Applications Information</i> section regarding stability issues when using an LEXT inductor.
18, 19	IF-, IF+	Differential IF Outputs. Each output requires external bias to V _{CC} through an RF choke (see the <i>Typical Application Circuit</i>).
20	IFBIAS	IF Bias Resistor Connection for IF Amplifier. Connect a 953Ω ±1% resistor from IFBIAS to GND.
EP	GND	Exposed Ground Paddle. Solder the exposed paddle to the ground plane using multiple vias.

Detailed Description

The MAX9986A high-linearity downconversion mixer provides 8.2dB of conversion gain and +25dBm of IIP3, with a typical 10dB noise figure. The integrated baluns and matching circuitry allow for 50Ω single-

ended interfaces to the RF and the two LO ports. A single-pole, double-throw (SPDT) switch provides 50ns switching time between the two LO inputs with 49dB of LO-to-LO isolation. Furthermore, the integrated LO buffer provides a high drive level to the mixer core, reducing the LO drive required at the MAX9986A's

SiGe High-Linearity, 815MHz to 1000MHz Downconversion Mixer with LO Buffer/Switch

MAX9986A

inputs to a -3dBm to +3dBm range. The IF port incorporates a differential output, which is ideal for providing enhanced IIP2 performance.

Specifications are guaranteed over broad frequency ranges to allow for use in cellular band GSM, cdma2000, iDEN, and WCDMA 2G/2.5G/3G base stations. The MAX9986A is specified to operate over a 815MHz to 1000MHz RF frequency range, a 960MHz to 1180MHz LO frequency range, and a 50MHz to 250MHz IF frequency range. Operation beyond these ranges is possible; see the *Typical Operating Characteristics* for additional details.

RF Input and Balun

The MAX9986A RF input is internally matched to 50Ω, requiring no external matching components. A DC-blocking capacitor is required because the input is internally DC shorted to ground through the on-chip balun.

LO Inputs, Buffer, and Balun

The MAX9986A is ideally suited for high-side LO injection applications with a 960MHz to 1180MHz LO frequency range. For a device with a 570MHz to 850MHz LO frequency range, refer to the MAX9984 data sheet. As an added feature, the MAX9986A includes an internal LO SPDT switch that can be used for frequency-hopping applications. The switch selects one of the two single-ended LO ports, allowing the external oscillator to settle on a particular frequency before it is switched in. LO switching time is typically less than 50ns, which is more than adequate for virtually all GSM applications. If frequency hopping is not employed, set the switch to either of the LO inputs. The switch is controlled by a digital input (LOSEL): logic-high selects LO2, logic-low selects LO1. To avoid damage to the part, voltage must be applied to VCC before digital logic is applied to LOSEL. LO1 and LO2 inputs are internally matched to 50Ω, requiring only an 82pF DC-blocking capacitor.

A two-stage internal LO buffer allows a wide input power range for the LO drive. All guaranteed specifications are for an LO signal power from -3dBm to +3dBm. The on-chip low-loss balun, along with an LO buffer, drives the double-balanced mixer. All interfacing and matching components from the LO inputs to the IF outputs are integrated on-chip.

High-Linearity Mixer

The core of the MAX9986A is a double-balanced, high-performance passive mixer. Exceptional linearity is provided by the large LO swing from the on-chip LO buffer. When combined with the integrated IF amplifiers, the cascaded IIP3, 2LO - 2RF rejection, and NF performance is typically 25dBm, 69dBc, and 10dB, respectively.

Differential IF Output Amplifier

The MAX9986A mixer has a 50MHz to 250MHz IF frequency range. The differential, open-collector IF output ports require external pullup inductors to VCC. Note that these differential outputs are ideal for providing enhanced 2LO - 2RF rejection performance. Single-ended IF applications require a 4:1 balun to transform the 200Ω differential output impedance to a 50Ω single-ended output.

Applications Information

Input and Output Matching

The RF and LO inputs are internally matched to 50Ω. No matching components are required. RF and LO inputs require only DC-blocking capacitors for interfacing.

The IF output impedance is 200Ω (differential). For evaluation, an external low-loss 4:1 (impedance ratio) balun transforms this impedance down to a 50Ω single-ended output (see the *Typical Application Circuit*).

Bias Resistors

Bias currents for the LO buffer and the IF amplifier are optimized by fine tuning resistors R1 and R2. If reduced current is required at the expense of performance, contact the factory for details. If the ±1% bias resistor values are not readily available, substitute standard ±5% values.

LEXT Inductor

Short LEXT to ground using a 0Ω resistor. For applications requiring improved RF-to-IF and LO-to-IF isolation, LEXT can be used by connecting a low-ESR inductor from LEXT to GND. See the *Typical Operating Characteristics* on RF-to-IF isolation and LO-to-IF leakage for various inductor values. However, the load impedance presented to the mixer must be such that any capacitance from both IF- and IF+ to ground do not exceed several picofarads to ensure stable operating conditions.

Since approximately 140mA flows through LEXT, it is important to use a low DCR wire-wound inductor.

Layout Considerations

A properly designed PC board is an essential part of any RF/microwave circuit. Keep RF signal lines as short as possible to reduce losses, radiation, and inductance. For the best performance, route the ground pin traces directly to the exposed pad under the package. The PC board exposed pad **MUST** be connected to the ground plane of the PC board. It is suggested that multiple vias be used to connect this pad to the lower level ground planes. This method provides a good RF/thermal conduction path for the device. Solder the exposed pad on the bottom of the device package to the PC board. The MAX9986A Evaluation Kit can be used as a

SiGe High-Linearity, 815MHz to 1000MHz Downconversion Mixer with LO Buffer/Switch

reference for board layout. Gerber files are available upon request at www.maxim-ic.com.

Power-Supply Bypassing

Proper voltage-supply bypassing is essential for high-frequency circuit stability. Bypass each V_{CC} pin and TAP with the capacitors shown in the *Typical Application Circuit*; see Table 1. Place the TAP bypass capacitor to ground within 100 mils of the TAP pin.

Exposed Pad RF/Thermal Considerations

The exposed paddle (EP) of the MAX9986A's 20-pin thin QFN package provides a low thermal-resistance path to the die. It is important that the PC board on which the MAX9986A is mounted be designed to conduct heat from the EP. In addition, provide the EP with a low-inductance path to electrical ground. The EP **MUST** be soldered to a ground plane on the PC board, either directly or through an array of plated via holes.

Table 1. Component List Referring to the Typical Application Circuit

COMPONENT	VALUE	DESCRIPTION
L1, L2	330nH	Wire-wound high-Q inductors (0805)
L3*	30nH	Wire-wound high-Q inductor (0603)
C1	10pF	Microwave capacitor (0603)
C2, C4, C7, C8, C10, C11, C12	82pF	Microwave capacitors (0603)
C3, C5, C6, C9, C13, C14	0.01μF	Microwave capacitors (0603)
C15	220pF	Microwave capacitor (0402)
R1	953Ω	±1% resistor (0603)
R2	619Ω	±1% resistor (0603)
R3	0Ω	±1% resistor (1206)
T1	4:1 balun	IF balun TC4-1W-7A
U1	MAX9986A	Maxim IC

*Use L3 for improved RF-to-IF and LO-to-IF isolation. See the Applications Information section regarding stability issues when using L3 inductor.

Pin Configuration/Functional Diagram

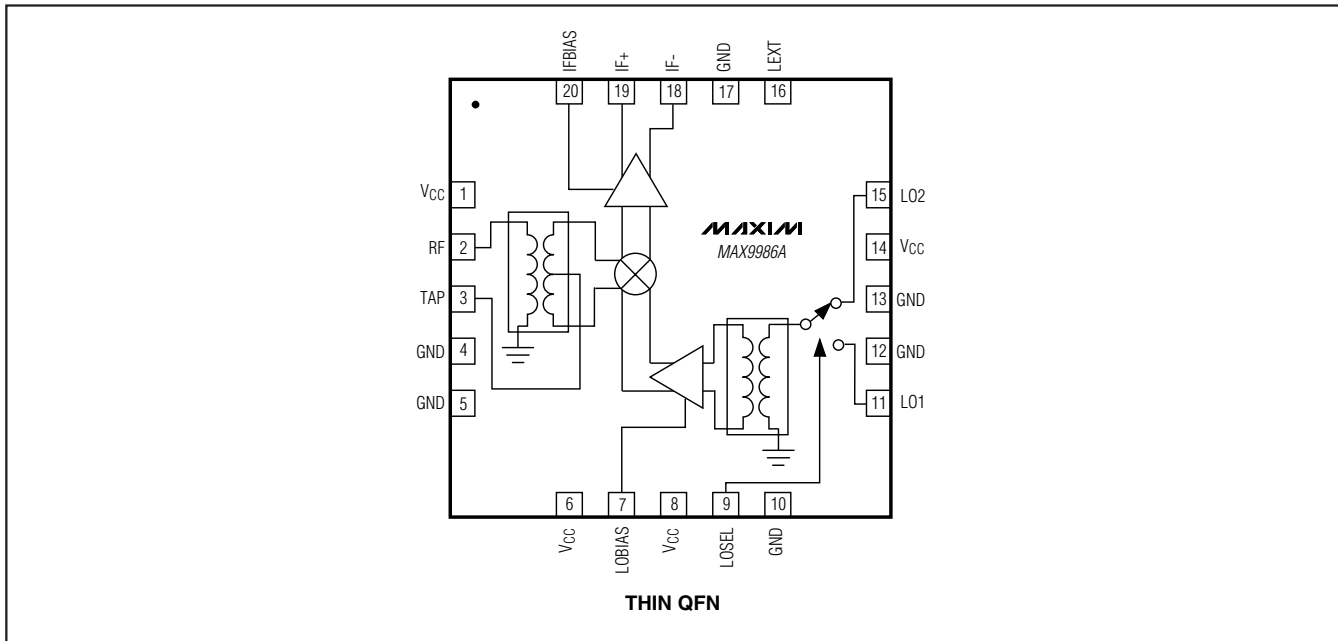

SiGe High-Linearity, 815MHz to 1000MHz Downconversion Mixer with LO Buffer/Switch

Typical Application Circuit

MAX9986A

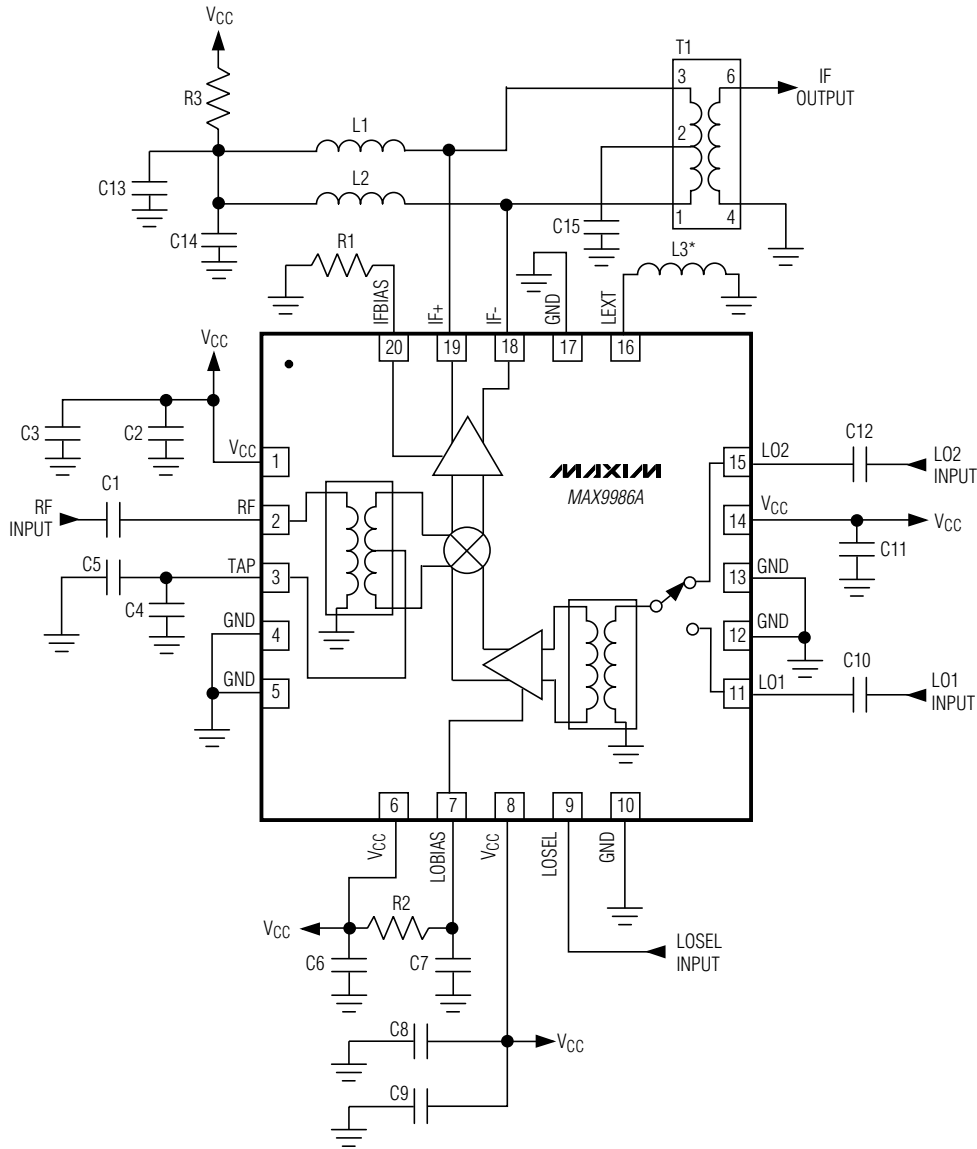

*USE L3 FOR IMPROVED RF-TO-IF AND LO-TO-IF ISOLATION. SEE THE *Applications Information* SECTION REGARDING STABILITY ISSUES WHEN USING L3 INDUCTOR.

Chip Information

TRANSISTOR COUNT: 1017

PROCESS: SiGe BiCMOS

SiGe High-Linearity, 815MHz to 1000MHz Downconversion Mixer with LO Buffer/Switch

Package Information

(The package drawing(s) in this data sheet may not reflect the most current specifications. For the latest package outline information go to www.maxim-ic.com/packages.)

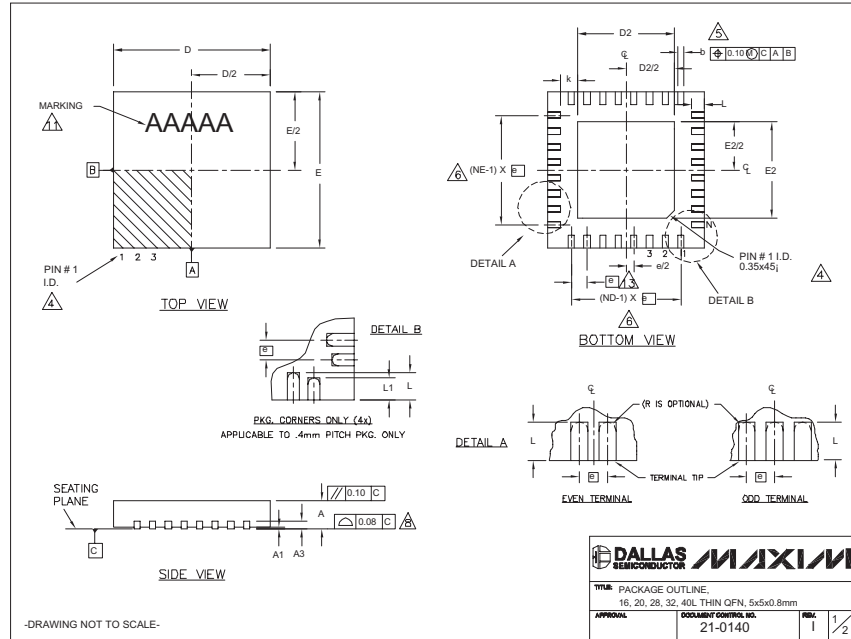

COMMON DIMENSIONS												
PKG. SYMBOL	16L 5x5		20L 5x5		28L 5x5		32L 5x5		40L 5x5			
	MIN.	NOM.	MAX.	MIN.	NOM.	MAX.	MIN.	NOM.	MAX.	MIN.	NOM.	MAX.
A	0.70	0.75	0.80	0.70	0.75	0.80	0.70	0.75	0.80	0.70	0.75	0.80
A1	0	0.02	0.05	0	0.02	0.05	0	0.02	0.05	0	0.02	0.05
A3	0.20 REF.		0.20 REF.		0.20 REF.		0.20 REF.		0.20 REF.			
b	0.25	0.30	0.35	0.25	0.30	0.35	0.20	0.25	0.30	0.20	0.25	0.30
D	4.90	5.00	5.10	4.90	5.00	5.10	4.90	5.00	5.10	4.90	5.00	5.10
E	4.90	5.00	5.10	4.90	5.00	5.10	4.90	5.00	5.10	4.90	5.00	5.10
e	0.80 BSC.		0.65 BSC.		0.50 BSC.		0.50 BSC.		0.40 BSC.			
k	0.25	-	-	0.25	-	-	0.25	-	-	0.25	0.35	0.45
L	0.30	0.40	0.50	0.45	0.55	0.65	0.45	0.55	0.65	0.30	0.40	0.50
L1	-	-	-	-	-	-	-	-	-	-	0.30	0.40
N	16			20			28			32		40
ND	4			5			7			8		10
NE	4			5			7			8		10
JEDEC	WHHB			WHHC			WHHD-1			WHHD-2		----

EXPOSED PAD VARIATIONS										
PKG. CODES	D2			E2			L		DOWN BONDS ALLOWED	
	MIN.	NOM.	MAX.	MIN.	NOM.	MAX.	-0.15			
T1655-2	3.00	3.10	3.20	3.00	3.10	3.20	**	NO	YES	
T1655-3	3.00	3.10	3.20	3.00	3.10	3.20	**	NO	NO	
T1655N-1	3.00	3.10	3.20	3.00	3.10	3.20	**	NO	NO	
T2055-3	3.00	3.10	3.20	3.00	3.10	3.20	**	NO	YES	
T2055-4	3.00	3.10	3.20	3.00	3.10	3.20	**	NO	NO	
T2055-5	3.15	3.25	3.35	3.15	3.25	3.35	0.40	YES	YES	
T2855-3	3.15	3.25	3.35	3.15	3.25	3.35	**	YES	YES	
T2855-4	2.60	2.70	2.80	2.60	2.70	2.80	**	YES	YES	
T2855-5	2.60	2.70	2.80	2.60	2.70	2.80	**	NO	NO	
T2855-6	3.15	3.25	3.35	3.15	3.25	3.35	**	NO	NO	
T2855-7	2.60	2.70	2.80	2.60	2.70	2.80	**	YES	YES	
T2855-8	3.15	3.25	3.35	3.15	3.25	3.35	0.40	YES	YES	
T2855N-1	3.15	3.25	3.35	3.15	3.25	3.35	**	NO	NO	
T3255-3	3.00	3.10	3.20	3.00	3.10	3.20	**	YES	YES	
T3255-4	3.00	3.10	3.20	3.00	3.10	3.20	**	NO	NO	
T3255-5	3.00	3.10	3.20	3.00	3.10	3.20	**	YES	YES	
T3255N-1	3.00	3.10	3.20	3.00	3.10	3.20	**	NO	NO	
T4055-1	3.20	3.30	3.40	3.20	3.30	3.40	**	YES	YES	

**SEE COMMON DIMENSIONS TABLE

NOTES:

- DIMENSIONING & TOLERANCING CONFORM TO ASME Y14.5M-1994.
- ALL DIMENSIONS ARE IN MILLIMETERS, ANGLES ARE IN DEGREES.
- N IS THE TOTAL NUMBER OF TERMINALS.
- THE TERMINAL #1 IDENTIFIER AND TERMINAL NUMBERING CONVENTION SHALL CONFORM TO JEDEC 95-1 SPP-012. DETAILS OF TERMINAL #1 IDENTIFIER ARE OPTIONAL, BUT MUST BE LOCATED WITHIN THE ZONE INDICATED. THE TERMINAL #1 IDENTIFIER MAY BE EITHER A MOLD OR MARKED FEATURE.
- DIMENSION b APPLIES TO METALLIZED TERMINAL AND IS MEASURED BETWEEN 0.25 mm AND 0.30 mm FROM TERMINAL TIP.
- ND AND NE REFER TO THE NUMBER OF TERMINALS ON EACH D AND E SIDE RESPECTIVELY.
- DEPOPULATION IS POSSIBLE IN A SYMMETRICAL FASHION.
- COPLANARITY APPLIES TO THE EXPOSED HEAT SINK SLUG AS WELL AS THE TERMINALS.
- DRAWING CONFORMS TO JEDEC MO220, EXCEPT EXPOSED PAD DIMENSION FOR T2855-3 AND T2855-6.
- WARPAGE SHALL NOT EXCEED 0.10 mm.
- MARKING IS FOR PACKAGE ORIENTATION REFERENCE ONLY.
- NUMBER OF LEADS SHOWN ARE FOR REFERENCE ONLY.
- LEAD CENTERLINES TO BE AT TRUE POSITION AS DEFINED BY BASIC DIMENSION "e", -0.05.

-DRAWING NOT TO SCALE-

<small>TITLE: PACKAGE OUTLINE 16, 20, 28, 32, 40L THIN OFN, 5x5x0.8mm</small>	
<small>APPROVAL</small> 21-0140	<small>DOCUMENT CONTROL NO.</small> 21-0140
<small>REV.</small> 1	<small>REV.</small> 1/2

Maxim cannot assume responsibility for use of any circuitry other than circuitry entirely embodied in a Maxim product. No circuit patent licenses are implied. Maxim reserves the right to change the circuitry and specifications without notice at any time.

12 **Maxim Integrated Products, 120 San Gabriel Drive, Sunnyvale, CA 94086 408-737-7600**