

### FEATURES

- 300 MHz internal clock rate
- FSK, BPSK, PSK, chirp, AM operation
- Dual integrated 12-bit D/A converters
- Ultrahigh speed comparator, 3 ps rms jitter
- Excellent dynamic performance
  - 80 dB SFDR at 100 MHz ( $\pm 1$  MHz)  $A_{OUT}$
- 4x to 20x programmable reference clock multiplier
- Dual 48-bit programmable frequency registers
- Dual 14-bit programmable phase offset registers
- 12-bit programmable amplitude modulation and on/off output shaped keying function
- Single-pin FSK and BPSK data interfaces
- PSK capability via I/O interface
- Linear or nonlinear FM chirp functions with single pin frequency hold function

- Frequency ramped FSK
- <25 ps rms total jitter in clock generator mode
- Automatic bidirectional frequency sweeping
- Sin(x)/x correction
- Simplified control interface
  - 10 MHz serial 2-wire or 3-wire SPI-compatible
  - 100 MHz parallel 8-bit programming
- 3.3 V single supply
- Multiple power-down functions
- Single-ended or differential input reference clock
- Small, 80-lead LQFP or TQFP with exposed pad

### APPLICATIONS

- Agile LO frequency synthesis
- Programmable clock generator
- FM chirp source for radar and scanning systems
- Test and measurement equipment
- Commercial and amateur RF exciter

### FUNCTIONAL BLOCK DIAGRAM

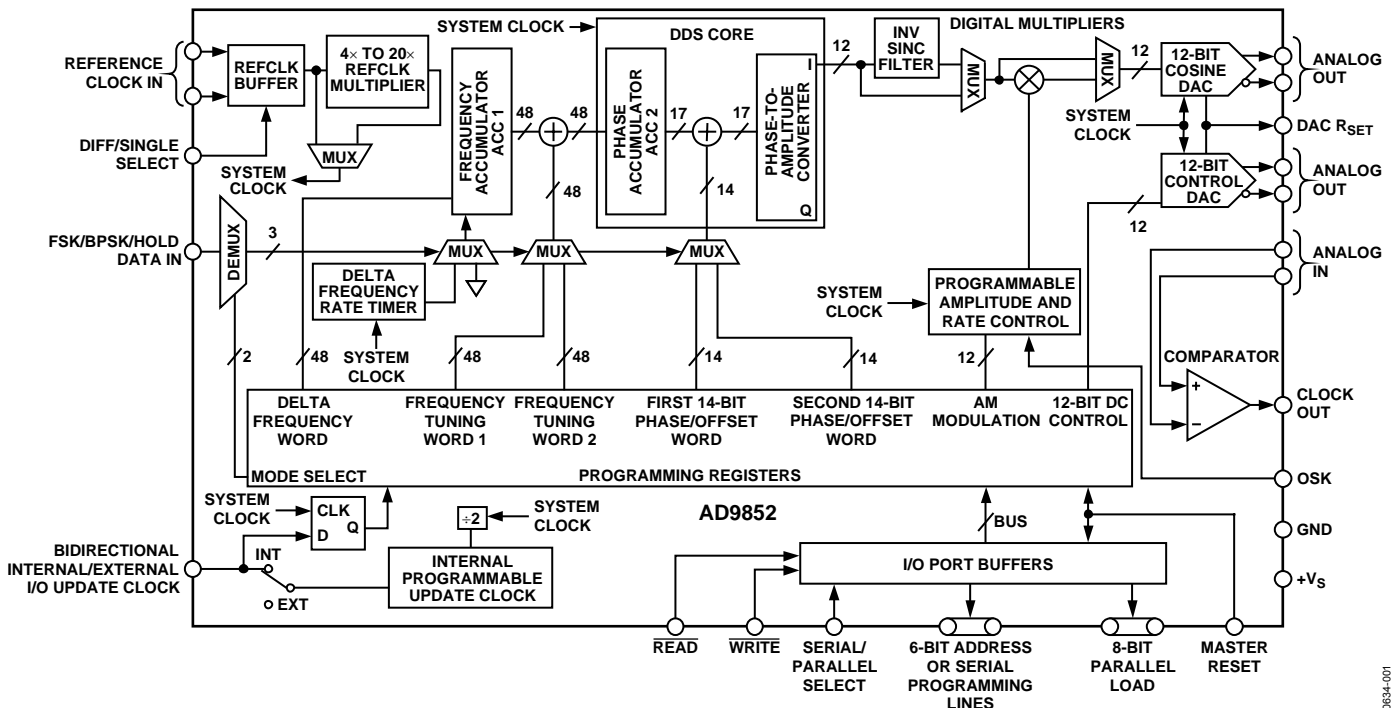

Figure 1.

### Rev. E

Information furnished by Analog Devices is believed to be accurate and reliable. However, no responsibility is assumed by Analog Devices for its use, nor for any infringements of patents or other rights of third parties that may result from its use. Specifications subject to change without notice. No license is granted by implication or otherwise under any patent or patent rights of Analog Devices. Trademarks and registered trademarks are the property of their respective owners.

**TABLE OF CONTENTS**

Features .....	1	Inverse Sinc Function .....	29
Applications.....	1	REFCLK Multiplier.....	29
Functional Block Diagram .....	1	High Speed Comparator.....	30
Revision History .....	3	Power-Down .....	30
General Description.....	4	Programming the AD9852.....	31
Overview.....	4	MASTER RESET .....	31
Specifications.....	5	Parallel I/O Operation .....	31
Absolute Maximum Ratings.....	8	Serial Port I/O Operation.....	31
Thermal Resistance .....	8	General Operation of the Serial Interface .....	34
Explanation of Test Levels.....	8	Instruction Byte .....	34
ESD Caution.....	8	Serial Interface Port Pin Descriptions .....	35
Pin Configuration and Function Descriptions.....	9	MSB/LSB Transfers .....	35
Typical Performance Characteristics .....	12	Control Register Descriptions .....	36
Typical Applications.....	16	Power Dissipation and Thermal Considerations .....	38
Modes of Operation .....	18	Thermal Impedance.....	38
Single Tone (Mode 000).....	18	Junction Temperature Considerations .....	38
Unramped FSK (Mode 001).....	19	Evaluation of Operating Conditions.....	40
Ramped FSK (Mode 010).....	19	Thermally Enhanced Package Mounting Guidelines.....	40
Chirp (Mode 011).....	22	Evaluation Board .....	41
BPSK (Mode 100).....	26	Evaluation Board Instructions.....	41
Using the AD9852 .....	27	General Operating Instructions .....	41
Internal and External Update Clock.....	27	Using the Provided Software .....	43
On/Off Output Shaped Keying (OSK) .....	27	Support .....	43
Cosine DAC .....	29	Outline Dimensions .....	51
Control DAC.....	29	Ordering Guide .....	52

**REVISION HISTORY****5/07—Rev. D to Rev. E**

Changed AD9852ASQ to AD9852ASVZ .....	Universal
Changed AD9852AST to AD9852ASTZ.....	Universal
Change to Features.....	1
Changes to Endnote 10 of Table 1.....	7
Changes to Absolute Maximum Ratings.....	8
Added Thermal Resistance Section .....	8
Change to Ramped FSK (Mode 010) Section.....	19
Change to Internal and External Update Clock Section.....	27
Change to Thermal Impedance Section.....	38
Changes to Junction Temperature Considerations Section.....	38
Changes to Thermally Enhanced Package Mounting Guidelines Section.....	40
Deleted Figure 61 to Figure 64 .....	41
Changes to Table 14 .....	44
Updated Outline Dimensions.....	51
Changes to Ordering Guide.....	52

**12/05—Rev. C to Rev. D**

Updated Format.....	Universal
Changes to General Description .....	4
Changes to Explanation of Test Levels Section .....	9
Change to Pin Configuration .....	10
Changes to Figure 65 .....	47
Changes to Outline Dimensions .....	52
Changes to Ordering Guide.....	52

**4/04—Rev. B to Rev. C**

Updated Format.....	Universal
Changes to Figure 1.....	1
Changes to General Description .....	3
Changes to Table 1 .....	4
Changes to Footnote 2 .....	6
Changes to Figure 2.....	8
Changes to Table 5 .....	17
Changes to Equation in Ramped FSK (Mode 010).....	19
Changes to Evaluation Board Instructions.....	39
Changes to General Operating Instructions Section.....	39
Changes to Using the Provided Software Section.....	42
Changes to Figure 65 .....	43
Changes to Figure 66 .....	44
Changes to Figure 72 and Figure 73 .....	48
Changes to Ordering Guide.....	48

**3/02—Rev. A to Rev. B**

Changes to General Description .....	1
Changes to Functional Block Diagram .....	1
Changes to Specifications .....	3
Changes to Absolute Maximum Ratings.....	5
Changes to Pin Function Descriptions .....	6
Changes to Figure 3 .....	8
Deleted Two TPCs .....	11
Changes to Figure 18 and Figure 19 .....	11
Changes to BPDK Mode Section .....	21
Changes to Differential Refclk Enable Section .....	24
Changes to Master Reset Section .....	24
Changes to Parallel I/O Operation Section .....	24
Changes to General Operation of the Serial Interface Section.....	27
Changes to Figure 50 .....	27
Changes to Figure 65 .....	36

## GENERAL DESCRIPTION

The AD9852 digital synthesizer is a highly integrated device that uses advanced DDS technology, coupled with an internal high speed, high performance D/A converter to form a digitally programmable, agile synthesizer function. When referenced to an accurate clock source, the AD9852 generates a highly stable frequency-, phase-, and amplitude-programmable cosine output that can be used as an agile LO in communications, radar, and many other applications. The innovative high speed DDS core of the AD9852 provides 48-bit frequency resolution (1  $\mu$ Hz tuning resolution with 300 MHz SYSCLK). Maintaining 17 bits ensures excellent SFDR.

The circuit architecture of the AD9852 allows the generation of output signals at frequencies up to 150 MHz, which can be digitally tuned at a rate of up to 100 million new frequencies per second. The (externally filtered) cosine wave output can be converted to a square wave by the internal comparator for agile clock generator applications. The device provides two 14-bit phase registers and a single pin for BPSK operation.

For higher-order PSK operation, the I/O interface can be used for phase changes. The 12-bit cosine DAC, coupled with the innovative DDS architecture, provides excellent wideband and narrow-band output SFDR. When configured with the comparator, the 12-bit control DAC facilitates static duty cycle control in the high speed clock generator applications.

The 12-bit digital multiplier permits programmable amplitude modulation, on/off output shaped keying, and precise amplitude control of the cosine DAC output. Chirp functionality is also included for wide bandwidth frequency sweeping applications.

The AD9852 programmable  $4\times$  to  $20\times$  REFCLK multiplier circuit internally generates the 300 MHz system clock from a lower frequency external reference clock. This saves the user the expense and difficulty of implementing a 300 MHz system clock source.

Direct 300 MHz clocking is also accommodated with either single-ended or differential inputs. Single-pin, conventional FSK and the enhanced spectral qualities of ramped FSK are supported. The AD9852 uses advanced 0.35  $\mu$  CMOS technology to provide this high level of functionality on a single 3.3 V supply.

The AD9852 is pin-for-pin compatible with the [AD9854](#) single-tone synthesizer. The AD9852 is specified to operate over the extended industrial temperature range of  $-40^{\circ}\text{C}$  to  $+85^{\circ}\text{C}$ .

## OVERVIEW

The AD9852 digital synthesizer is a highly flexible device that addresses a wide range of applications. The device consists of an NCO with a 48-bit phase accumulator, a programmable reference clock multiplier, an inverse sinc filter, a digital multiplier, two 12-bit/300 MHz DACs, a high speed analog comparator, and an interface logic. This highly integrated device can be configured to serve as a synthesized LO agile clock generator and FSK/BPSK modulator. The theory of operation for the functional blocks of the device and a technical description of the signal flow through a DDS device is provided by Analog Devices, Inc., in the tutorial [A Technical Tutorial on Digital Signal Synthesis](#). The tutorial also provides basic applications information for a variety of digital synthesis implementations.

## SPECIFICATIONS

$V_S = 3.3\text{ V} \pm 5\%$ ,  $R_{SET} = 3.9\text{ k}\Omega$ , external reference clock frequency = 30 MHz with REFCLK multiplier enabled at 10× for AD9852ASVZ, external reference clock frequency = 20 MHz with REFCLK multiplier enabled at 10× for AD9852ASTZ, unless otherwise noted.

**Table 1.**

Parameter	Temp	Test Level	AD9852ASVZ			AD9852ASTZ			Unit
			Min	Typ	Max	Min	Typ	Max	
<b>REFERENCE CLOCK INPUT CHARACTERISTICS<sup>1</sup></b>									
Internal System Clock Frequency Range									
REFCLK Multiplier Enabled	Full	VI	20		300	20		200	MHz
REFCLK Multiplier Disabled	Full	VI	DC		300	DC		200	MHz
External Reference Clock Frequency Range									
REFCLK Multiplier Enabled	Full	VI	5		75	5		50	MHz
REFCLK Multiplier Disabled	Full	VI	DC		300	DC		200	MHz
Duty Cycle	25°C	IV	45	50	55	45	50	55	%
Input Capacitance	25°C	IV		3			3		pF
Input Impedance	25°C	IV		100			100		kΩ
Differential Common-Mode Voltage Range									
Minimum Signal Amplitude <sup>2</sup>	25°C	IV	400			400			mV p-p
Common-Mode Range	25°C	IV	1.6	1.75	1.9	1.6	1.75	1.9	V
$V_{IH}$ (Single-Ended Mode)	25°C	IV	2.3			2.3			V
$V_{IL}$ (Single-Ended Mode)	25°C	IV			1			1	V
<b>DAC STATIC OUTPUT CHARACTERISTICS</b>									
Output Update Speed	Full	I			300			200	MSPS
Resolution	25°C	IV		12			12		Bits
Cosine and Control DAC Full-Scale Output Current	25°C	IV	5	10	20	5	10	20	mA
Gain Error	25°C	I	-6		+2.2	-6		+2.2	% FS
					5			5	
Output Offset	25°C	I			2			2	μA
Differential Nonlinearity	25°C	I		0.3	1.25		0.3	1.25	LSB
Integral Nonlinearity	25°C	I		0.6	1.66		0.6	1.66	LSB
Output Impedance	25°C	IV		100			100		kΩ
Voltage Compliance Range	25°C	I	-0.5		+1.0	-0.5		+1.0	V
<b>DAC DYNAMIC OUTPUT CHARACTERISTICS</b>									
<b>DAC Wideband SFDR</b>									
1 MHz to 20 MHz $A_{OUT}$	25°C	V		58			58		dBc
20 MHz to 40 MHz $A_{OUT}$	25°C	V		56			56		dBc
40 MHz to 60 MHz $A_{OUT}$	25°C	V		52			52		dBc
60 MHz to 80 MHz $A_{OUT}$	25°C	V		48			48		dBc
80 MHz to 100 MHz $A_{OUT}$	25°C	V		48			48		dBc
100 MHz to 120 MHz $A_{OUT}$	25°C	V		48					dBc
<b>DAC Narrow-Band SFDR</b>									
10 MHz $A_{OUT}$ ( $\pm 1$ MHz)	25°C	V		83			83		dBc
10 MHz $A_{OUT}$ ( $\pm 250$ kHz)	25°C	V		83			83		dBc
10 MHz $A_{OUT}$ ( $\pm 50$ kHz)	25°C	V		91			91		dBc
41 MHz $A_{OUT}$ ( $\pm 1$ MHz)	25°C	V		82			82		dBc
41 MHz $A_{OUT}$ ( $\pm 250$ kHz)	25°C	V		84			84		dBc
41 MHz $A_{OUT}$ ( $\pm 50$ kHz)	25°C	V		89			89		dBc
119 MHz $A_{OUT}$ ( $\pm 1$ MHz)	25°C	V		71					dBc
119 MHz $A_{OUT}$ ( $\pm 250$ kHz)	25°C	V		77					dBc
119 MHz $A_{OUT}$ ( $\pm 50$ kHz)	25°C	V		83					dBc

# AD9852

Parameter	Temp	Test Level	AD9852ASVZ			AD9852ASTZ			Unit
			Min	Typ	Max	Min	Typ	Max	
Residual Phase Noise									
(A <sub>OUT</sub> = 5 MHz, External Clock = 30 MHz, REFCLK Multiplier Engaged at 10x)									
1 kHz Offset	25°C	V		140			140		dBc/Hz
10 kHz Offset	25°C	V		138			138		dBc/Hz
100 kHz Offset	25°C	V		142			142		dBc/Hz
(A <sub>OUT</sub> = 5 MHz, External Clock = 300 MHz, REFCLK Multiplier Bypassed)									
1 kHz Offset	25°C	V		142			142		dBc/Hz
0 kHz Offset	25°C	V		148			148		dBc/Hz
100 kHz Offset	25°C	V		152			152		dBc/Hz
PIPELINE DELAYS <sup>3, 4, 5</sup>									
DDS Core (Phase Accumulator and Phase-to-Amp Converter)	25°C	IV		33			33		SYSCLK cycles
Frequency Accumulator	25°C	IV		26			26		SYSCLK cycles
Inverse Sinc Filter	25°C	IV		16			16		SYSCLK cycles
Digital Multiplier	25°C	IV		9			9		SYSCLK cycles
DAC	25°C	IV		1			1		SYSCLK cycles
I/O Update Clock (Internal Mode)	25°C	IV		2			2		SYSCLK cycles
I/O Update Clock (External Mode)	25°C	IV		3			3		SYSCLK cycles
MASTER RESET DURATION	25°C	IV	10				10		SYSCLK cycles
COMPARATOR INPUT CHARACTERISTICS									
Input Capacitance	25°C	V		3			3		pF
Input Resistance	25°C	IV		500			500		kΩ
Input Current	25°C	I		±1	±5		±1	±5	μA
Hysteresis	25°C	IV		10	20		10	20	mV p-p
COMPARATOR OUTPUT CHARACTERISTICS									
Logic 1 Voltage, High-Z Load	Full	VI	3.1			3.1			V
Logic 0 Voltage, High-Z Load	Full	VI			0.16			0.16	V
Output Power, 50 Ω Load, 120 MHz Toggle Rate	25°C	I	9	11		9	11		dBm
Propagation Delay	25°C	IV		3			3		ns
Output Duty Cycle Error <sup>6</sup>	25°C	I	-10	±1	+10	-10	±1	+10	%
Rise/Fall Time, 5 pF Load	25°C	V		2			2		ns
Toggle Rate, High-Z Load	25°C	IV	300	350		300	350		MHz
Toggle Rate, 50 Ω Load	25°C	IV	375	400		375	400		MHz
Output Cycle-to-Cycle Jitter <sup>7</sup>	25°C	IV			4.0			4.0	ps rms
COMPARATOR NARROW-BAND SFDR <sup>8</sup>									
10 MHz (±1 MHz)	25°C	V		84			84		dBc
10 MHz (±250 MHz)	25°C	V		84			84		dBc
10 MHz (±50 kHz)	25°C	V		92			92		dBc
41 MHz (±1 MHz)	25°C	V		76			76		dBc
41 MHz (±250 kHz)	25°C	V		82			82		dBc
41 MHz (±50 kHz)	25°C	V		89			89		dBc
119 MHz (±1 MHz)	25°C	V		73			73		dBc
119 MHz (±250 kHz)	25°C	V		73			73		dBc
119 MHz (±50 kHz)	25°C	V		83			83		dBc
CLOCK GENERATOR OUTPUT JITTER <sup>8</sup>									
5 MHz A <sub>OUT</sub>	25°C	V		23			23		ps rms
40 MHz A <sub>OUT</sub>	25°C	V		12			12		ps rms
100 MHz A <sub>OUT</sub>	25°C	V		7			7		ps rms

Parameter	Temp	Test Level	AD9852ASVZ			AD9852ASTZ			Unit
			Min	Typ	Max	Min	Typ	Max	
<b>PARALLEL I/O TIMING CHARACTERISTICS</b>									
t <sub>ASU</sub> (Address Setup Time to $\overline{\text{WR}}$ Signal Active)	Full	IV	8.0	7.5		8.0	7.5		ns
t <sub>ADHW</sub> (Address Hold Time to $\overline{\text{WR}}$ Signal Inactive)	Full	IV	0			0			ns
t <sub>DSU</sub> (Data Setup Time to $\overline{\text{WR}}$ Signal Inactive)	Full	IV	3.0	1.6		3.0	1.6		ns
t <sub>DHD</sub> (Data Hold Time to $\overline{\text{WR}}$ Signal Inactive)	Full	IV	0			0			ns
t <sub>WRLOW</sub> ( $\overline{\text{WR}}$ Signal Minimum Low Time)	Full	IV	2.5	1.8		2.5	1.8		ns
t <sub>WRHIGH</sub> ( $\overline{\text{WR}}$ Signal Minimum High Time)	Full	IV	7			7			ns
t <sub>WR</sub> (Minimum $\overline{\text{WR}}$ Time)	Full	IV	10.5			10.5			ns
t <sub>ADV</sub> (Address to Data Valid Time)	Full	V	15		15	15		15	ns
t <sub>ADHR</sub> (Address Hold Time to $\overline{\text{RD}}$ Signal Inactive)	Full	IV	5			5			ns
t <sub>RDLOV</sub> ( $\overline{\text{RD}}$ Low to Output Valid)	Full	IV			15			15	ns
t <sub>RDHOZ</sub> ( $\overline{\text{RD}}$ High to Data Three-State)	Full	IV			10			10	ns
<b>SERIAL I/O TIMING CHARACTERISTICS</b>									
t <sub>PRE</sub> ( $\overline{\text{CS}}$ Setup Time)	Full	IV	30			30			ns
t <sub>SCLK</sub> (Period of Serial Data Clock)	Full	IV	100			100			ns
t <sub>DSU</sub> (Serial Data Setup Time)	Full	IV	30			30			ns
t <sub>SCLKPWH</sub> (Serial Data Clock Pulse Width High)	Full	IV	40			40			ns
t <sub>SCLKPWL</sub> (Serial Data Clock Pulse Width Low)	Full	IV	40			40			ns
t <sub>DHLD</sub> (Serial Data Hold Time)	Full	IV	0			0			ns
t <sub>DV</sub> (Data Valid Time)	Full	V		30			30		ns
<b>CMOS LOGIC INPUTS <sup>9</sup></b>									
Logic 1 Voltage	25°C	I	2.2			2.2			V
Logic 0 Voltage	25°C	I			0.8			0.8	V
Logic 1 Current	25°C	IV			± 5			± 12	μA
Logic 0 Current	25°C	IV			± 5			± 12	μA
Input Capacitance	25°C	V		3			3		pF
<b>POWER SUPPLY<sup>10</sup></b>									
V <sub>S</sub> Current <sup>11</sup>	25°C	I		815	922		585	660	mA
V <sub>S</sub> Current <sup>12</sup>	25°C	I		640	725		465	520	mA
V <sub>S</sub> Current <sup>13</sup>	25°C	I		585	660		425	475	mA
P <sub>DISS</sub> <sup>11</sup>	25°C	I		2.70	3.20		1.93	2.39	W
P <sub>DISS</sub> <sup>12</sup>	25°C	I		2.12	2.52		1.53	1.81	W
P <sub>DISS</sub> <sup>13</sup>	25°C	I		1.93	2.29		1.40	1.65	W
P <sub>DISS</sub> Power-Down Mode	25°C	I		1	50		1	50	mW

<sup>1</sup> The reference clock inputs are configured to accept a 1 V p-p (typical) dc offset square or sine waves centered at one-half the applied V<sub>DD</sub> or a 3 V TTL-level pulse input.

<sup>2</sup> An internal 400 mV p-p differential voltage swing equates to 200 mV p-p applied to both REFCLK input pins.

<sup>3</sup> Pipeline delays of each individual block are fixed; however, if the first eight MSBs of a tuning word are all 0s, the delay appears longer. This is due to insufficient phase accumulation per a system clock period to produce enough LSB amplitude to the D/A converter.

<sup>4</sup> If a feature such as inverse sinc, which has 16 pipeline delays, can be bypassed, the total delay is reduced by that amount.

<sup>5</sup> The I/O UD CLK transfers data from the I/O port buffers to the programming registers. This transfer is measured in system clocks.

<sup>6</sup> A change in duty cycle from 1 MHz to 100 MHz with 1 V p-p sine wave input and 0.5 V threshold.

<sup>7</sup> Represents the comparator's inherent cycle-to-cycle jitter contribution. The input signal is a 1 V, 40 MHz square wave, and the measurement device is a Wavecrest DTS-2075.

<sup>8</sup> Comparator input originates from analog output section via external 7-pole elliptic low-pass filter. Single-ended input, 0.5 V p-p. Comparator output terminated in 50 Ω.

<sup>9</sup> Avoid overdriving digital inputs. (Refer to equivalent circuits in Figure 3.)

<sup>10</sup> If all device functions are enabled, it is not recommended to simultaneously operate the device at the maximum ambient temperature of 85°C and at the maximum internal clock frequency. This configuration may result in violating the maximum die junction temperature of 150°C. Refer to the Power Dissipation and Thermal Considerations section for derating and thermal management information.

<sup>11</sup> All functions engaged.

<sup>12</sup> All functions except inverse sinc engaged.

<sup>13</sup> All functions except inverse sinc and digital multipliers engaged.

## ABSOLUTE MAXIMUM RATINGS

Table 2.

Parameter	Rating
Maximum Junction Temperature	150°C
V <sub>S</sub>	4 V
Digital Inputs	−0.7 V to +V <sub>S</sub>
Digital Output Current	5 mA
Storage Temperature	−65°C to +150°C
Operating Temperature	−40°C to +85°C
Lead Temperature (Soldering, 10 sec)	300°C
Maximum Clock Frequency (ASVZ)	300 MHz
Maximum Clock Frequency (ASTZ)	200 MHz

Stresses above those listed under Absolute Maximum Ratings may cause permanent damage to the device. This is a stress rating only; functional operation of the device at these or any other conditions above those indicated in the operational section of this specification is not implied. Exposure to absolute maximum rating conditions for extended periods may affect device reliability.

### THERMAL RESISTANCE

The heat sink of the AD9852ASVZ 80-lead TQFP package must be soldered to the PCB.

Table 3.

Thermal Characteristic	TQFP	LQFP
θ <sub>JA</sub> (0 m/sec airflow) <sup>1, 2, 3</sup>	16.2°C/W	38°C/W
θ <sub>JMA</sub> (1.0 m/sec airflow) <sup>2, 3, 4, 5</sup>	13.7°C/W	
θ <sub>JMA</sub> (2.5 m/sec airflow) <sup>2, 3, 4, 5</sup>	12.8°C/W	
Ψ <sub>JT</sub> <sup>1, 2</sup>	0.3°C/W	
θ <sub>JC</sub> <sup>6, 7</sup>	2.0°C/W	

<sup>1</sup> Per JEDEC JESD51-2 (heat sink soldered to PCB).

<sup>2</sup> 2S2P JEDEC test board.

<sup>3</sup> Values of θ<sub>JA</sub> are provided for package comparison and PCB design considerations.

<sup>4</sup> Per JEDEC JESD51-6 (heat sink soldered to PCB).

<sup>5</sup> Airflow increases heat dissipation, effectively reducing θ<sub>JA</sub>. Furthermore, the more metal that is directly in contact with the package leads from metal traces through holes, ground, and power planes, the more θ<sub>JA</sub> is reduced.

<sup>6</sup> Per MIL-Std 883, Method 1012.1.

<sup>7</sup> Values of θ<sub>JC</sub> are provided for package comparison and PCB design considerations when an external heat sink is required.

To determine the junction temperature on the application PCB use the following equation:

$$T_J = T_{case} + (\Psi_{JT} \times PD)$$

where:

T<sub>J</sub> is the junction temperature expressed in degrees Celsius.

T<sub>case</sub> is the case temperature expressed in degrees Celsius, as measured by the user at the top center of the package.

Ψ<sub>JT</sub> = 0.3°C/W.

PD is the power dissipation (PD); see the Power Dissipation and Thermal Considerations section for the method to calculate PD.

### EXPLANATION OF TEST LEVELS

Table 4.

Test Level	Description
I	100% production tested.
III	Sample tested only.
IV	Parameter is guaranteed by design and characterization testing.
V	Parameter is a typical value only.
VI	Devices are 100% production tested at 25°C and guaranteed by design and characterization testing for industrial operating temperature range.

### ESD CAUTION



#### ESD (electrostatic discharge) sensitive device.

Charged devices and circuit boards can discharge without detection. Although this product features patented or proprietary protection circuitry, damage may occur on devices subjected to high energy ESD. Therefore, proper ESD precautions should be taken to avoid performance degradation or loss of functionality.



## PIN CONFIGURATION AND FUNCTION DESCRIPTIONS

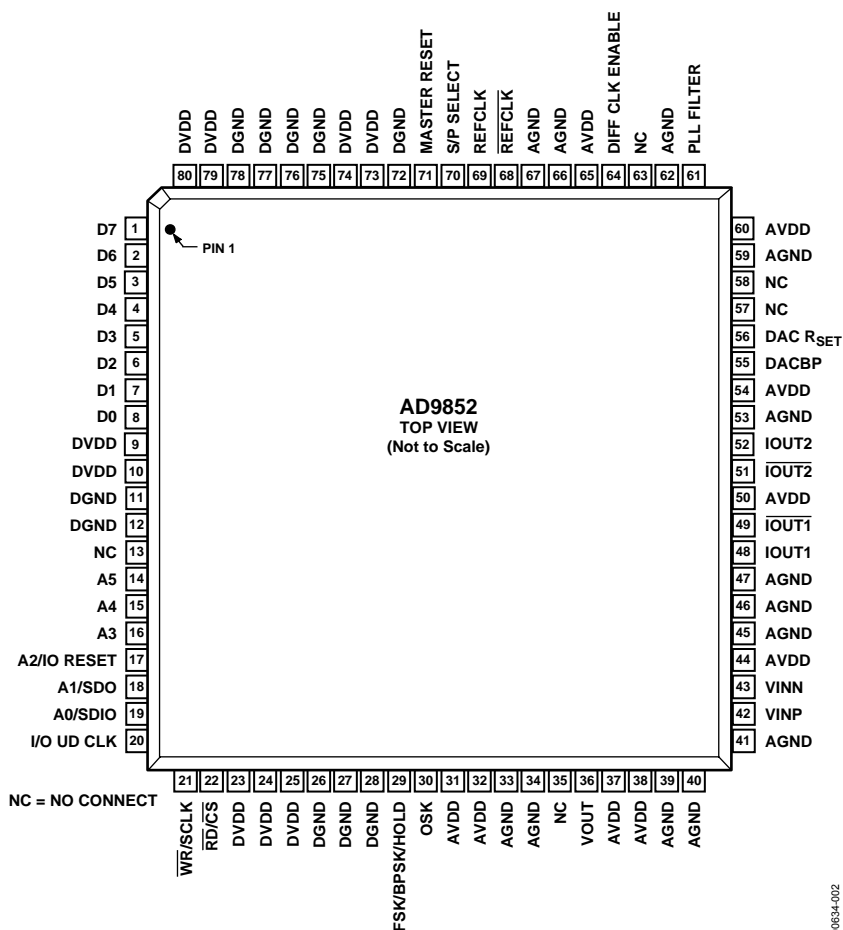

Figure 2. Pin Configuration

Table 5. Pin Function Descriptions

Pin Number	Mnemonic	Description
1 to 8	D7 to D0	8-Bit Bidirectional Parallel Programming Data Inputs. Used only in parallel programming mode.
9, 10, 23, 24, 25, 73, 74, 79, 80	DVDD	Connections for the Digital Circuitry Supply Voltage. Nominally 3.3 V more positive than AGND and DGND.
11, 12, 26, 27, 28, 72, 75 to 78	DGND	Connections for Digital Circuitry Ground Return. Same potential as AGND.
13, 35, 57, 58, 63	NC	No Internal Connection.
14 to 16	A5 to A3	Parallel Address Inputs for Program Registers (Part of 6-Bit Parallel Address Inputs for Program Register, A5:A0). Used only in parallel programming mode.
17	A2/IO RESET	Parallel Address Input for Program Registers (Part of 6-Bit Parallel Address Inputs for Program Register, A5:A0)/IO Reset. A2 is used only in parallel programming mode. IO RESET is used when the serial programming mode is selected, allowing an IO RESET of the serial communication bus that is unresponsive due to improper programming protocol. Resetting the serial bus in this manner does not affect previous programming, nor does it invoke the default programming values seen in Table 9. Active high.
18	A1/SDO	Parallel Address Input for Program Registers (Part of 6-Bit Parallel Address Inputs for Program Register, A5:A0)/Unidirectional Serial Data Output. A1 is used only in parallel programming mode. SDO is used in 3-wire serial communication mode when the serial programming mode is selected.

# AD9852

Pin Number	Mnemonic	Description
19	A0/SDIO	Parallel Address Input for Program Registers (Part of 6-Bit Parallel Address Inputs for Program Register, A5:A0)/Bidirectional Serial Data Input/Output. A0 is used only in parallel programming mode. SDIO is used in 2-wire serial communication mode.
20	I/O UD CLK	Bidirectional I/O Update Clock. Direction is selected in control register. If selected as an input, a rising edge transfers the contents of the I/O port buffers to the programming registers. If I/O UD CLK is selected as an output (default), an output pulse (low to high) with a duration of eight system clock cycles indicates that an internal frequency update has occurred.
21	$\overline{\text{WR}}/\text{SCLK}$	Write Parallel Data to I/O Port Buffers. Shared function with SCLK. Serial clock signal associated with the serial programming bus. Data is registered on the rising edge. This pin is shared with $\overline{\text{WR}}$ when the parallel mode is selected. The mode is dependent on Pin 70 (S/P SELECT).
22	$\overline{\text{RD}}/\overline{\text{CS}}$	Read Parallel Data from Programming Registers. Shared function with $\overline{\text{CS}}$ . Chip select signal associated with the serial programming bus. Active low. This pin is shared with $\overline{\text{RD}}$ when the parallel mode is selected.
29	FSK/BPSK/HOLD	Multifunction Pin. Functions according to the mode of operation selected in the programming control register. If in the FSK mode, logic low selects F1 and logic high selects F2. If in the BPSK mode, logic low selects Phase 1 and logic high selects Phase 2. In chirp mode, logic high engages the hold function, causing the frequency accumulator to halt at its current location. To resume or commence chirp, logic low is asserted.
30	OSK	Output Shaped Keying. Must first be selected in the programming control register to function. A logic high causes the cosine DAC outputs to ramp up from zero-scale to full-scale amplitude at a preprogrammed rate. Logic low causes the full-scale output to ramp down to zero scale at the preprogrammed rate.
31, 32, 37, 38, 44, 50, 54, 60, 65	AVDD	Connections for the Analog Circuitry Supply Voltage. Nominally 3.3 V more positive than AGND and DGND.
33, 34, 39, 40, 41, 45, 46, 47, 53, 59, 62, 66, 67	AGND	Connections for Analog Circuitry Ground Return. Same potential as DGND.
36	VOUT	Noninverted Output of the Internal High Speed Comparator. Designed to drive 10 dBm to 50 $\Omega$ loads as well as standard CMOS logic levels.
42	VINP	Voltage Input Positive. The noninverting input of the internal high speed comparator.
43	VINN	Voltage Input Negative. The inverting input of the internal high speed comparator.
48	IOUT1	Unipolar Current Output of the Cosine DAC (refer to Figure 3).
49	$\overline{\text{IOUT1}}$	Complementary Unipolar Current Output of the Cosine DAC.
51	$\overline{\text{IOUT2}}$	Complementary Unipolar Current Output of the Control DAC.
52	IOUT2	Unipolar Current Output of the Control DAC.
55	DACBP	Common Bypass Capacitor Connection for Both DACs. A 0.01 $\mu\text{F}$ chip capacitor from this pin to AVDD improves harmonic distortion and SFDR slightly. No connect is permissible, but results in a slight degradation in SFDR.
56	DAC R <sub>SET</sub>	Common Connection for Both DACs. Used to set the full-scale output current. $R_{\text{SET}} = 39.9 / I_{\text{OUT}}$ . Normal $R_{\text{SET}}$ range is from 8 k $\Omega$ (5 mA) to 2 k $\Omega$ (20 mA).
61	PLL FILTER	Connection for the External Zero-Compensation Network of the REFCLK Multiplier's PLL Loop Filter. The zero-compensation network consists of a 1.3 k $\Omega$ resistor in series with a 0.01 $\mu\text{F}$ capacitor. The other side of the network should be connected to AVDD as close as possible to Pin 60. For optimum phase noise performance, the REFCLK multiplier can be bypassed by setting the bypass PLL bit in Control Register 1E hex.
64	DIFF CLK ENABLE	Differential REFCLK Enable. A high level of this pin enables the differential clock inputs, REFCLK and $\overline{\text{REFCLK}}$ (Pin 69 and Pin 68, respectively).
68	$\overline{\text{REFCLK}}$	Complementary (180° Out of Phase) Differential Clock Signal. User should tie this pin high or low when single-ended clock mode is selected. Same signal levels as REFCLK.
69	REFCLK	Single-Ended (CMOS Logic Levels Required) Reference Clock Input or One of Two Differential Clock Signals. In differential reference clock mode, both inputs can be CMOS logic levels or have greater than 400 mV p-p square or sine waves centered about 1.6 V dc.
70	S/P SELECT	Selects between serial programming mode (logic low) and parallel programming mode (logic high).
71	MASTER RESET	Initializes the serial/parallel programming bus to prepare for user programming, and sets programming registers to a do-nothing state defined by the default values listed in Table 9. Active on logic high. Asserting this pin is essential for proper operation upon power-up.

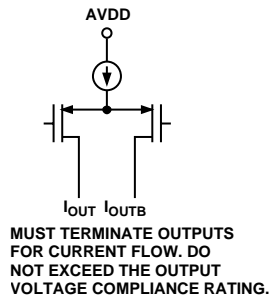

A. DAC Outputs

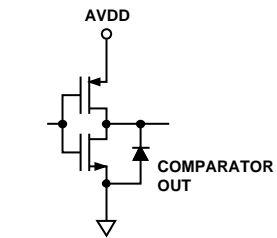

B. Comparator Output

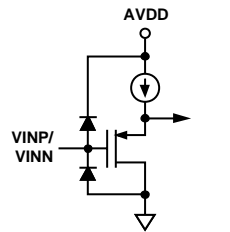

C. Comparator Input

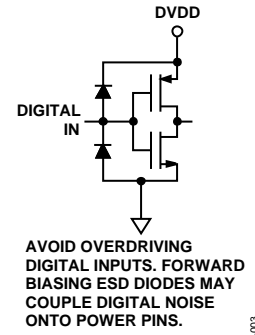

D. Digital Inputs

Figure 3. Equivalent Input and Output Circuits

00634-003

## TYPICAL PERFORMANCE CHARACTERISTICS

Figure 4 to Figure 9 indicate the wideband harmonic distortion performance of the AD9852 from 19.1 MHz to 119.1 MHz fundamental output, reference clock = 30 MHz, REFCLK multiplier = 10x. Each graph is plotted from 0 MHz to 150 MHz (Nyquist).

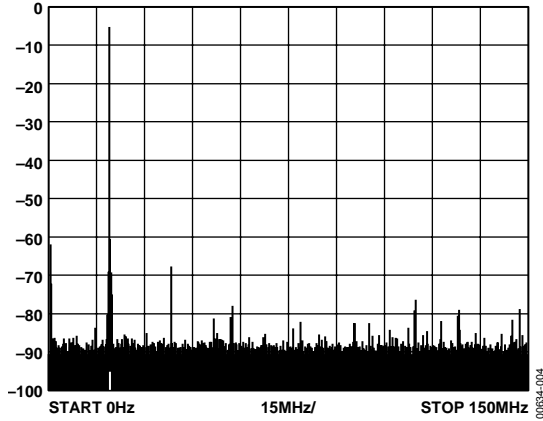

Figure 4. Wideband SFDR, 19.1 MHz

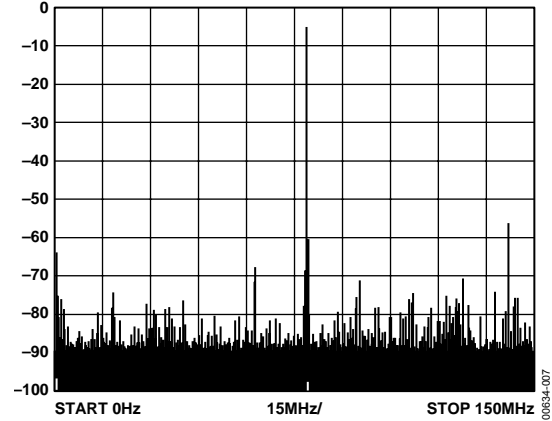

Figure 7. Wideband SFDR, 79.1 MHz

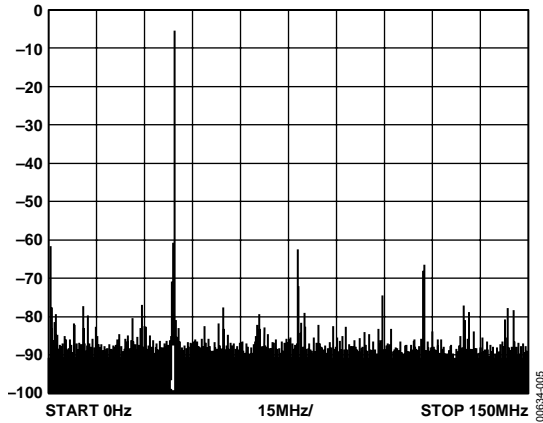

Figure 5. Wideband SFDR, 39.1 MHz

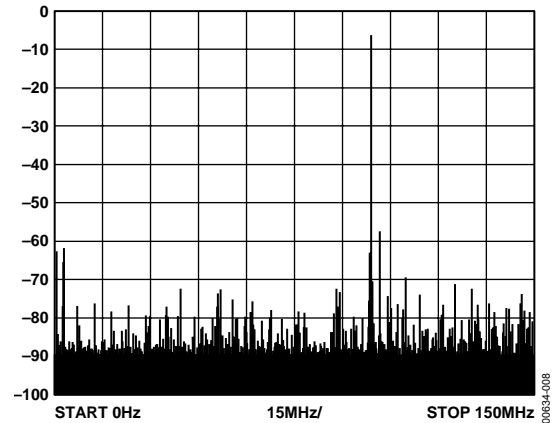

Figure 8. Wideband SFDR, 99.1 MHz

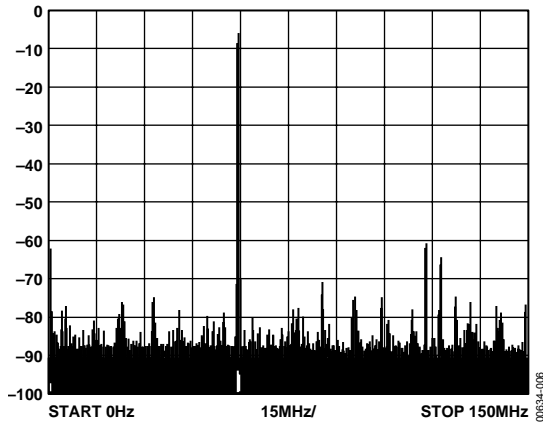

Figure 6. Wideband SFDR, 59.1 MHz

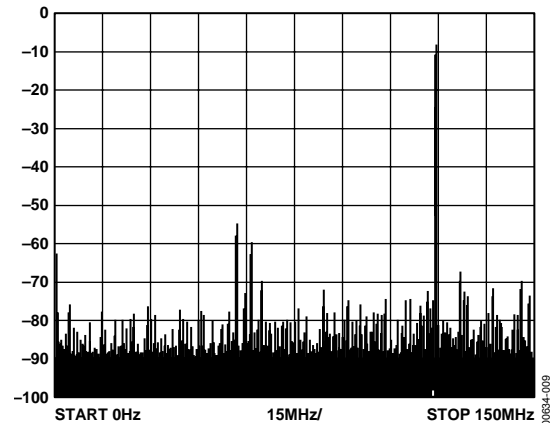

Figure 9. Wideband SFDR, 119.1 MHz

Figure 10 to Figure 15 show the trade-off in elevated noise floor, increased phase noise (PN), and discrete spurious energy when the internal REFCLK multiplier circuit is engaged. Plots with wide (1 MHz) and narrow (50 kHz) spans are shown. Compare the noise floor of Figure 11 and Figure 12 with that of Figure 14 and Figure 15. The improvement seen in Figure 11 and Figure 12 is a direct result of sampling the fundamental at a higher rate. Sampling at a higher rate spreads the quantization noise of the DAC over a wider bandwidth, which effectively lowers the noise floor.

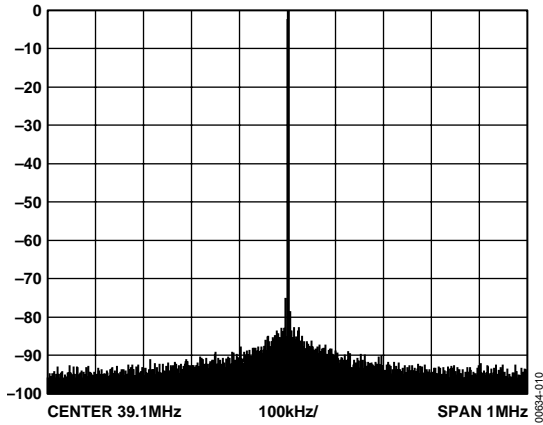

Figure 10. Narrow-Band SFDR, 39.1 MHz, 1 MHz BW, 300 MHz REFCLK with REFCLK Multiplier Bypassed

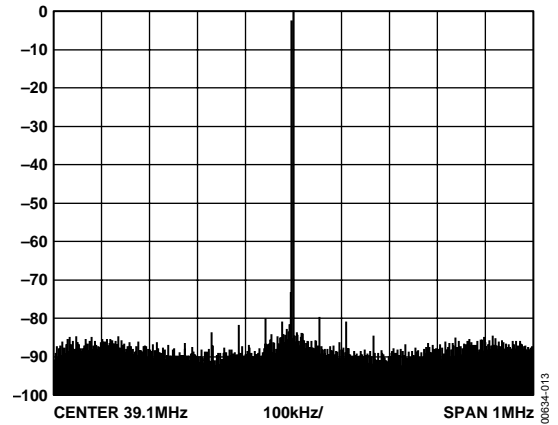

Figure 13. Narrow-Band SFDR, 39.1 MHz, 1 MHz BW, 30 MHz REFCLK with REFCLK Multiplier = 10x

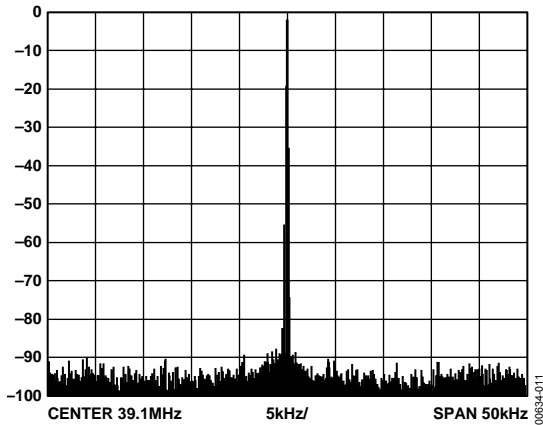

Figure 11. Narrow-Band SFDR, 39.1 MHz, 50 kHz BW, 300 MHz REFCLK with REFCLK Multiplier Bypassed

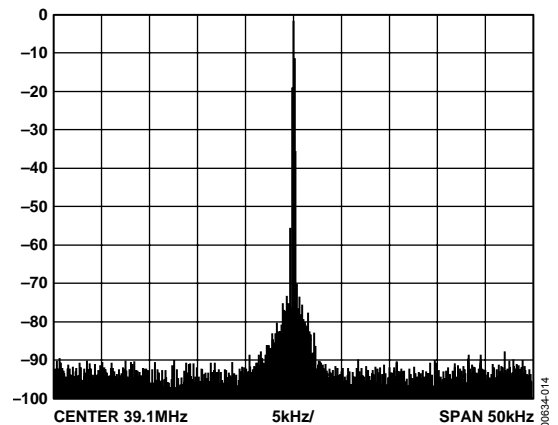

Figure 14. Narrow-Band SFDR, 39.1 MHz, 50 kHz BW, 30 MHz REFCLK with REFCLK Multiplier = 10x

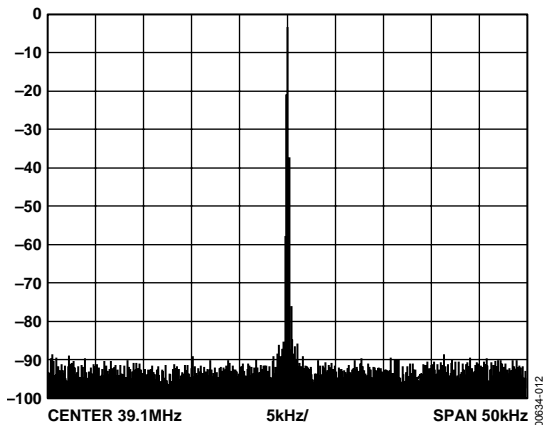

Figure 12. Narrow-Band SFDR, 39.1 MHz, 50 kHz BW, 100 MHz REFCLK with REFCLK Multiplier Bypassed

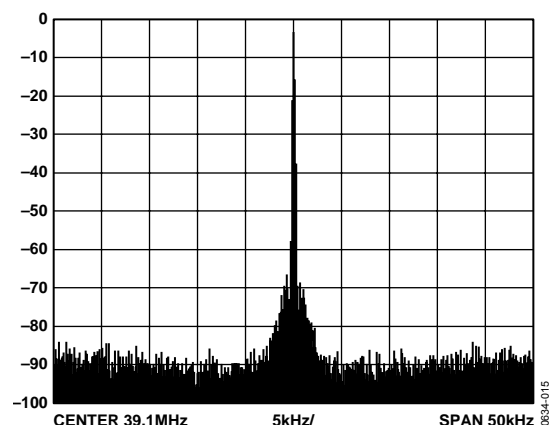

Figure 15. Narrow-Band SFDR, 39.1 MHz, 50 kHz BW, 10 MHz REFCLK with REFCLK Multiplier = 10x

Figure 18 and Figure 19 show the residual phase noise performance of the AD9852 when operating with a 300 MHz reference clock with the REFCLK multiplier bypassed vs. a 30 MHz reference clock with the REFCLK multiplier enabled at 10x.

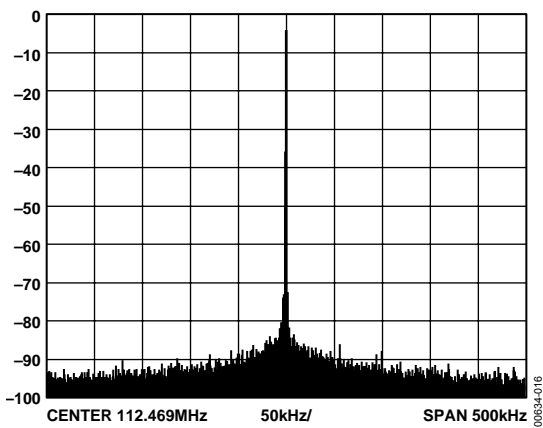

Figure 16. A Slight Change in Tuning Word Yields Dramatically Better Results; 112.469 MHz with All Spurs Shifted Out-of-Band, 300 MHz REFCLK

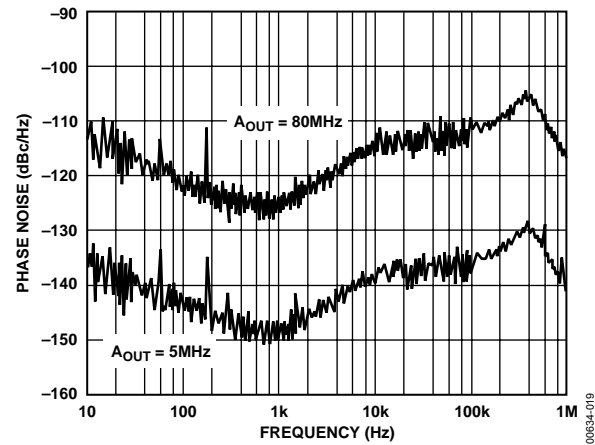

Figure 19. Residual Phase Noise, 30 MHz REFCLK with REFCLK Multiplier = 10x

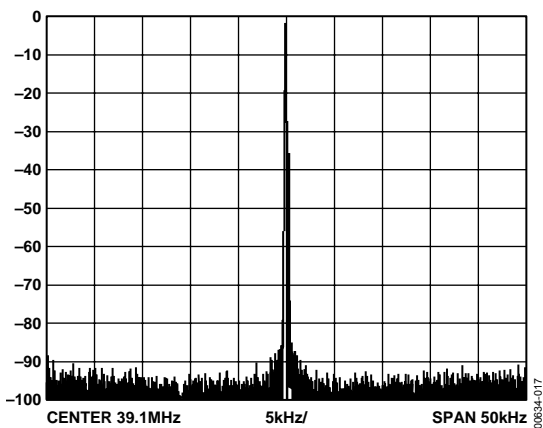

Figure 17. Narrow-Band SFDR, 39.1 MHz, 50 kHz BW, 200 MHz REFCLK with REFCLK Multiplier Bypassed



Figure 20. SFDR vs. DAC Current, 59.1 A<sub>OUT</sub>, 300 MHz REFCLK with REFCLK Multiplier Bypassed

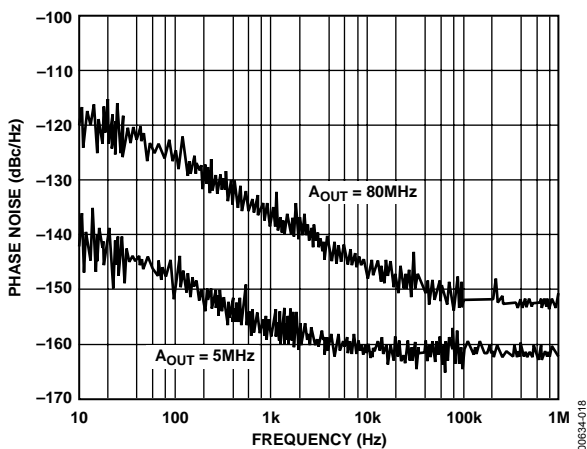

Figure 18. Residual Phase Noise, 300 MHz REFCLK with REFCLK Multiplier Bypassed

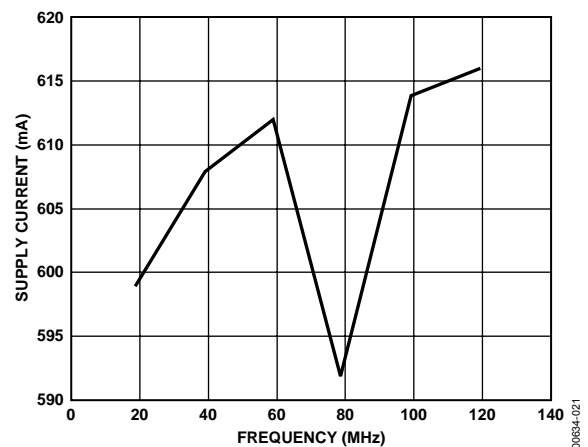

Figure 21. Supply Current vs. Output Frequency (Variation Is Minimal, Expressed as a Percentage, and Heavily Dependent on Tuning Word)

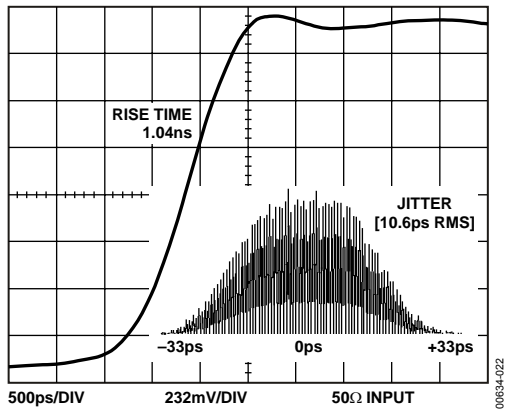

Figure 22. Typical Comparator Output Jitter, 40 MHz  $A_{OUT}$ , 300 MHz REFCLK with REFCLK Multiplier Bypassed

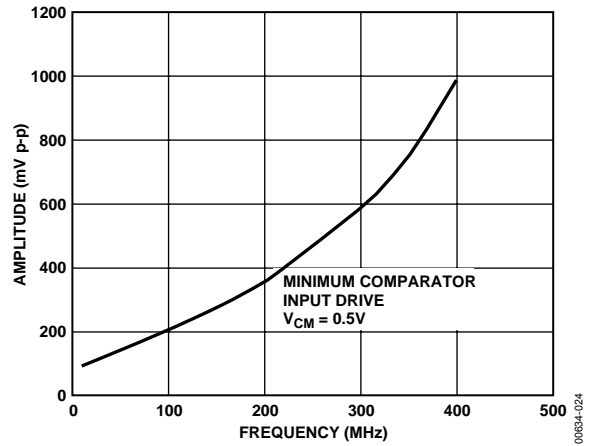

Figure 24. Comparator Toggle Voltage Requirement

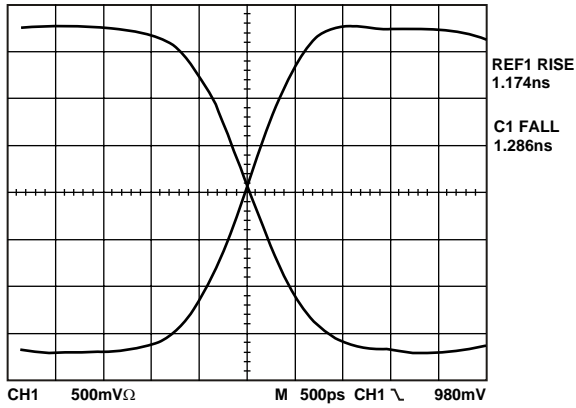

Figure 23. Comparator Rise/Fall Times

## TYPICAL APPLICATIONS

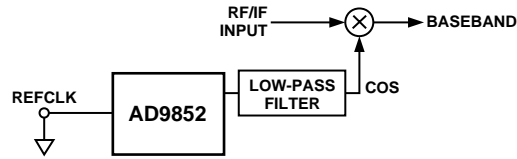

Figure 25. Synthesized LO Application for the AD9852

00634-025

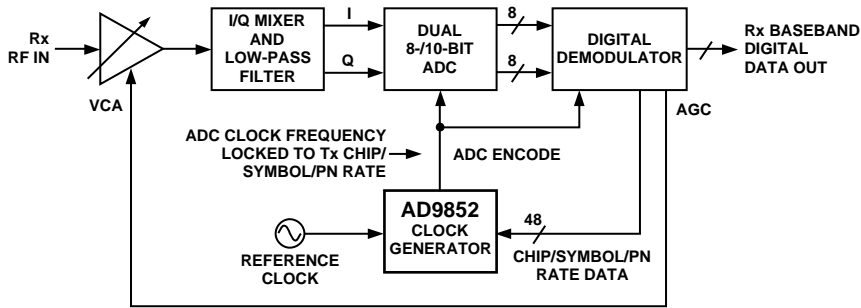

Figure 26. Chip Rate Generator in Spread Spectrum Application

00634-026

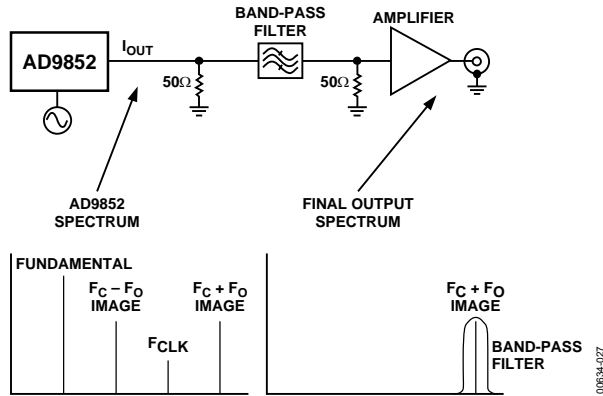

Figure 27. Using an Aliased Image to Generate a High Frequency

00634-027

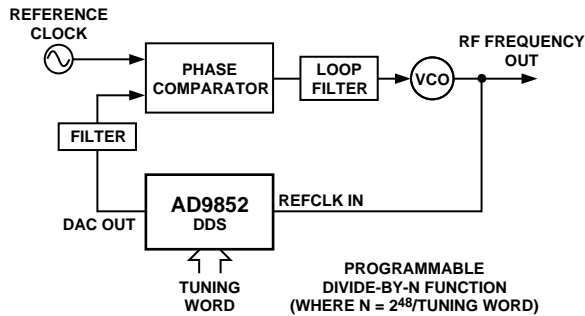

Figure 28. Programmable Fractional Divide-by-N Synthesizer

00634-028



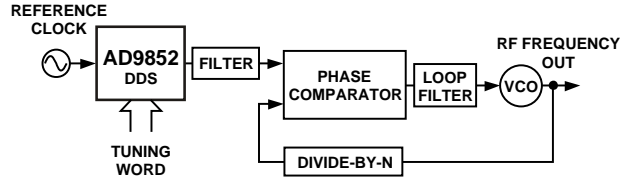

Figure 29. Agile High Frequency Synthesizer

00634-029

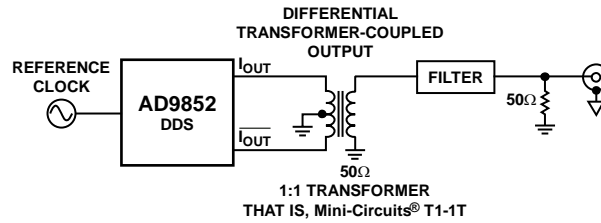

Figure 30. Differential Output Connection for Reduction of Common-Mode Signals

00634-030

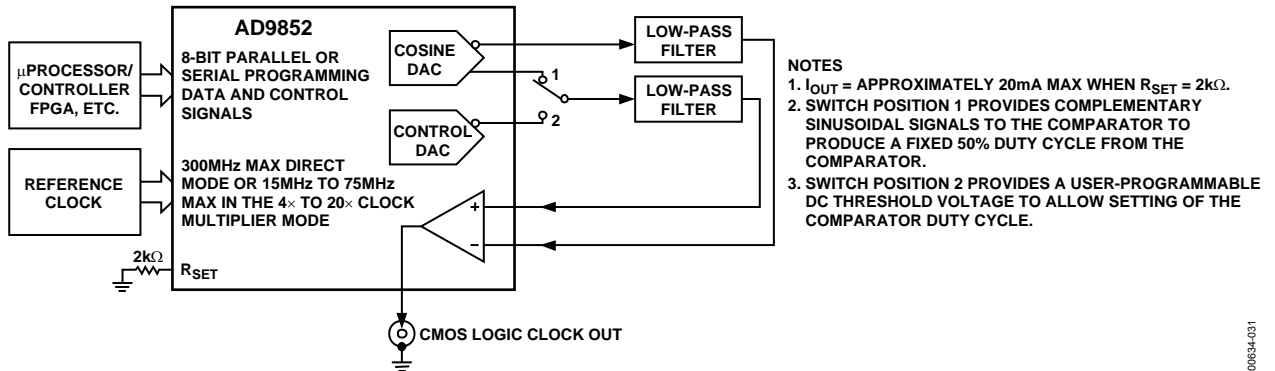

Figure 31. Frequency Agile Clock Generator Applications for the AD9852

00634-031

## MODES OF OPERATION

There are five programmable modes of operation of the AD9852. Selecting a mode requires that three bits in the control register (Parallel Address 1F hex) be programmed as shown in Table 6.

**Table 6. Mode Selection Table**

Mode 2	Mode 1	Mode 0	Result
0	0	0	Single tone
0	0	1	FSK
0	1	0	Ramped FSK
0	1	1	Chirp
1	0	0	BPSK

In each mode, engaging certain functions may be prohibited. Table 7 lists some important functions and their availability for each mode.

### SINGLE TONE (MODE 000)

When the MASTER RESET pin is asserted, single-tone mode becomes the default. The user can also access this mode by programming it into the control register. The phase accumulator, responsible for generating an output frequency, is presented with a 48-bit value from the Frequency Tuning Word 1 registers with default values of 0. Default values from the remaining applicable registers further define the single-tone output signal qualities.

The default values after a master reset configures the device with an output signal of 0 Hz and zero phase. Upon power-up and reset, the output from both DACs is a dc value equal to the midscale output current. This is the default mode amplitude setting of 0. Refer to the On/Off Output Shaped Keying (OSK) section for further explanation of the output amplitude control. It is necessary to program all or some of the 28 program registers to produce a user-defined output signal. Figure 32 shows the transition from the default condition (0 Hz) to a user-defined output frequency (F1).

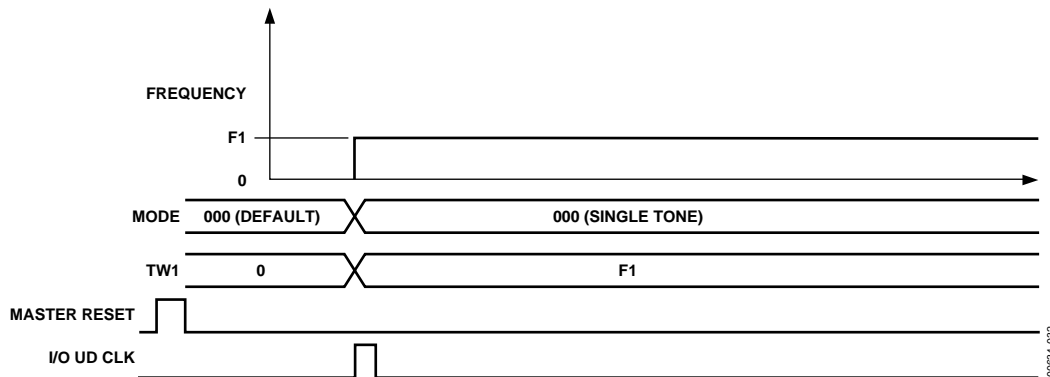

Figure 32. Default State to User-Defined Output Transition

As with all Analog Devices DDS devices, the value of the frequency tuning word is determined using the following equation:

$$FTW = (\text{Desired Output Frequency} \times 2^N) / \text{SYSCLK}$$

where:

$N$  is the phase accumulator resolution (48 bits in this instance).

*Desired Output Frequency* is expressed in hertz.

*FTW* (frequency tuning word) is a decimal number.

After a decimal number has been calculated, it must be rounded to an integer and then converted to binary format—a series of 48 binary-weighted 1s and 0s. The fundamental sine wave DAC output frequency range is from dc to one-half SYSCLK.

Changes in frequency are phase continuous; therefore, the first sampled phase value of the new frequency is referenced from the time of the last sampled phase value of the previous frequency.

The 14-bit phase register adjusts the cosine DAC's output phase.

The single-tone mode allows the user to control the following signal qualities:

- Output frequency to 48-bit accuracy
- Output amplitude to 12-bit accuracy
  - Fixed, user-defined amplitude control
  - Variable, programmable amplitude control
  - Automatic, programmable, single-pin-controlled on/off output shaped keying
- Output phase to 14-bit accuracy

Furthermore, all of these qualities can be changed or modulated via the 8-bit parallel programming port at a 100 MHz parallel byte rate or at a 10 MHz serial rate. Incorporating this attribute permits FM, AM, PM, FSK, PSK, and ASK operation in the single-tone mode.

**Table 7. Function Availability vs. Mode of Operation**

Function	Single-Tone Mode	FSK Mode	Ramped FSK Mode	Chirp Mode	BPSK Mode
Phase Adjust 1	•	•	•	•	•
Phase Adjust 2					•
Single-Pin FSK/BPSK or HOLD		•	•	•	•
Single-Pin Output Shaped Keying	•	•	•	•	•
Phase Offset or Modulation	•	•	•	•	
Amplitude Control or Modulation	•	•	•	•	•
Inverse Sinc Filter	•	•	•	•	•
Frequency Tuning Word 1	•	•	•	•	•
Frequency Tuning Word 2		•	•		
Automatic Frequency Sweep			•	•	

**UNRAMPED FSK (MODE 001)**

When this mode is selected, the output frequency of the DDS is a function of the values loaded into Frequency Tuning Word Register 1 and Frequency Tuning Word Register 2 and the logic level of Pin 29 (FSK/BPSK/HOLD). A logic low on Pin 29 chooses F1 (Frequency Tuning Word 1, Parallel Address 4 hex to Parallel Address 9 hex), and a logic high chooses F2 (Frequency Tuning Word 2, Parallel Register Address A hex to Parallel Register Address F hex). Changes in frequency are phase continuous and are internally coincident with the FSK data pin (Pin 29); however, there is deterministic pipeline delay between the FSK data signal and the DAC output (see Table 1).

The unramped FSK mode (see Figure 33) is representative of traditional FSK, radio teletype (RTTY), or teletype (TTY) transmission of digital data. FSK is a very reliable means of digital communication; however, it makes inefficient use of the bandwidth in the RF spectrum. Ramped FSK, shown in Figure 34, is a method of conserving the bandwidth.

**RAMPED FSK (MODE 010)**

In this method of FSK, changes from F1 to F2 are not instantaneous, but are accomplished in a frequency sweep or ramped fashion. The ramped notation implies the sweep is linear. Although linear sweeping, or frequency ramping, is easily and automatically accomplished, it is only one of many possibilities. Other frequency transition schemes can be implemented by changing the ramp rate and ramp step size at any time during operation.

Frequency ramping, whether linear or nonlinear, necessitates that many intermediate frequencies between F1 and F2 are output in addition to the primary F1 and F2 frequencies. Figure 34 and Figure 35 graphically depict the frequency vs. time characteristics of a linear ramped FSK signal.

In ramped FSK mode, the delta frequency word (DFW) is required to be programmed as a positive twos complement value. Another requirement is that the lowest frequency (F1) be programmed in the Frequency Tuning Word 1 registers.

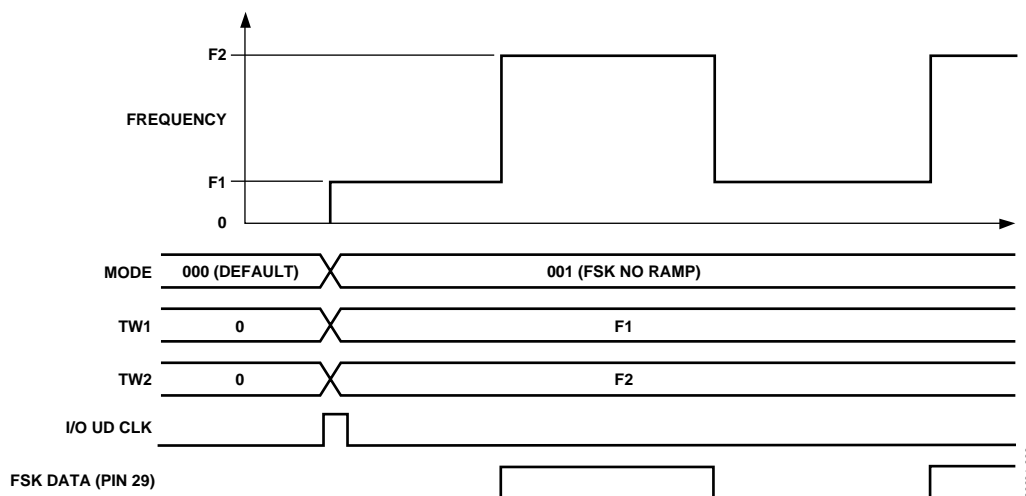

Figure 33. Unramped (Traditional) FSK Mode

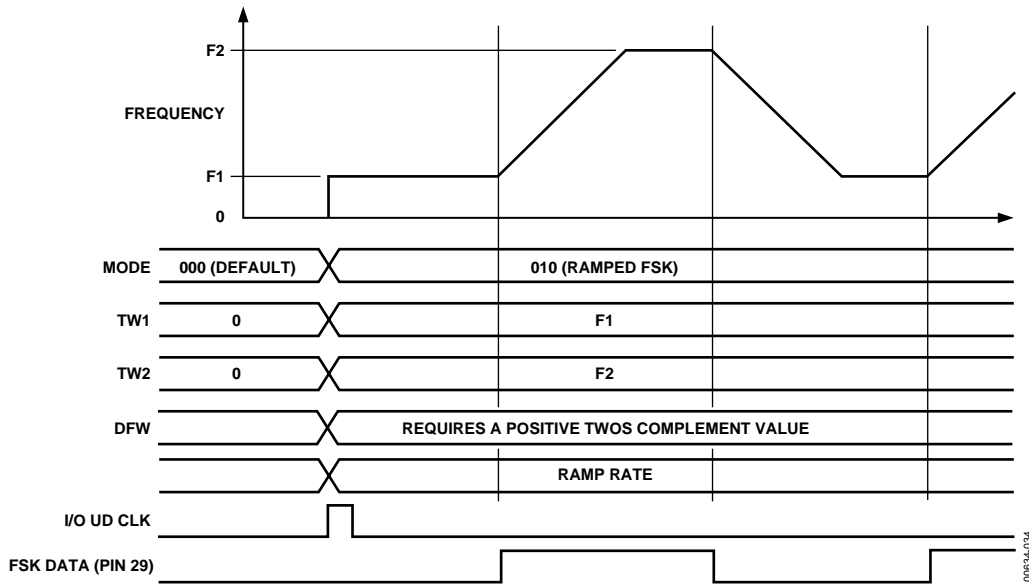

Figure 34. Ramped FSK Mode (Start at F1)

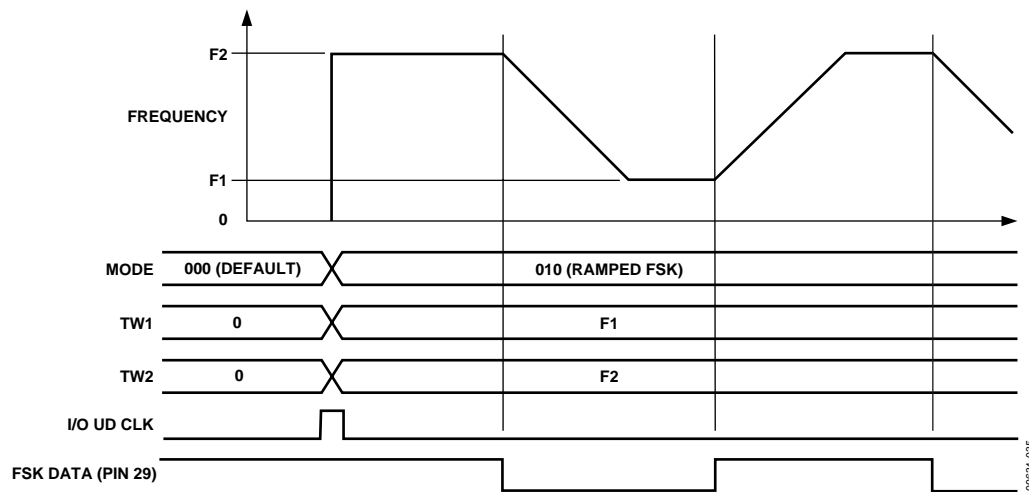

Figure 35. Ramped FSK Mode (Start at F2)

The purpose of ramped FSK is to provide better bandwidth containment than can be achieved using traditional FSK. In ramped FSK, the instantaneous frequency changes of traditional FSK are replaced with more gradual, user-defined frequency changes. The dwell time at F1 and F2 can be equal to or much greater than the time spent at each intermediate frequency. The user controls the dwell time at F1 and F2, the number of intermediate frequencies, and the time spent at each frequency. Unlike unramped FSK, ramped FSK requires the lowest frequency to be loaded into the F1 registers and the highest frequency to be loaded into the F2 registers.

Several registers must be programmed to instruct the DDS regarding the resolution of intermediate frequency steps (48 bits) and the time spent at each step (20 bits). Furthermore, the CLR ACC1 bit in the control register should be toggled (low-high-low) prior to operation to ensure that the frequency accumulator is starting from an all 0s output condition.

For piecewise, nonlinear frequency transitions, it is necessary to reprogram the registers while the frequency transition is in progress to affect the desired response.

Parallel Register Address 1A hex to Parallel Register Address 1C hex comprise the 20-bit ramp rate clock registers. This is a countdown counter that outputs a single pulse whenever the count reaches 0. The counter is activated any time a logic level change occurs on the FSK input (Pin 29). This counter is run at the system clock rate, 300 MHz maximum. The time period between each output pulse is

$$(N + 1) \times \text{System Clock Period}$$

where  $N$  is the 20-bit ramp rate clock value programmed by the user.

The allowable range of  $N$  is from 1 to  $(2^{20} - 1)$ . The output of this counter clocks the 48-bit frequency accumulator shown in

Figure 36. The ramp rate clock determines the amount of time spent at each intermediate frequency between F1 and F2.

The counter stops automatically when the destination frequency is achieved. The dwell time spent at F1 and F2 is determined by the duration that the FSK input (Pin 29) is held high or low after the destination frequency has been reached.

Parallel Register Address 10 hex to Parallel Register Address 15 hex comprise the 48-bit, twos complement delta frequency word registers. This 48-bit word is accumulated (added to the accumulator's output) every time it receives a clock pulse from the ramp rate counter. The output of this accumulator is added to or subtracted from the F1 or F2 frequency word, which is then fed into the input of the 48-bit phase accumulator that forms the numerical phase steps for the sine and cosine wave outputs. In this fashion, the output frequency is ramped up and down in frequency according to the logic state of Pin 29. This ramping rate is a function of the 20-bit ramp rate clock. When the destination frequency is achieved, the ramp rate clock is stopped, halting the frequency accumulation process.

Generally speaking, the delta frequency word is a much smaller value compared with the value of the F1 or F2 tuning word. For example, if F1 and F2 are 1 kHz apart at 13 MHz, the delta frequency word might be only 25 Hz.

Figure 39 shows that premature toggling causes the ramp to immediately reverse itself and proceed at the same rate and resolution until the original frequency is reached.

The control register contains a triangle bit at Parallel Register Address 1F hex. Setting this bit high in Mode 010 causes an automatic ramp-up and ramp-down between F1 and F2 to occur without toggling Pin 29 (shown in Figure 37). In fact, the logic state of Pin 29 has no effect once the triangle bit is set high. This function uses the ramp rate clock time period and the step size of the delta frequency word to form a continuously sweeping linear ramp from F1 to F2 and back to F1 with equal dwell times at every frequency. Use this function to automatically sweep between any two frequencies from dc to Nyquist.

In the ramped FSK mode with the triangle bit set high, an automatic frequency sweep begins at either F1 or F2, according to the logic level on Pin 29 (FSK input pin) when the triangle bit's rising edge occurs, as shown in Figure 38. If the FSK data bit is high instead of low, F2, rather than F1, is chosen as the start frequency.

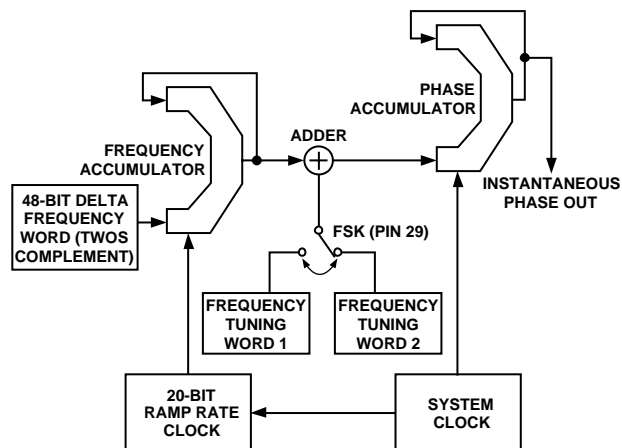

Figure 36. Block Diagram of Ramped FSK Function

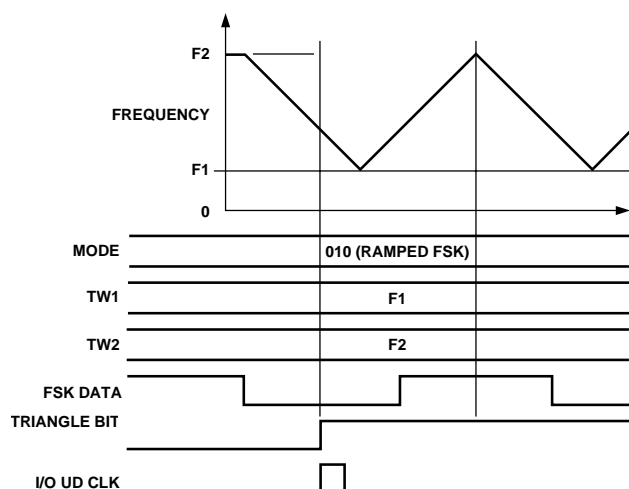

Figure 37. Effect of Triangle Bit in Ramped FSK Mode

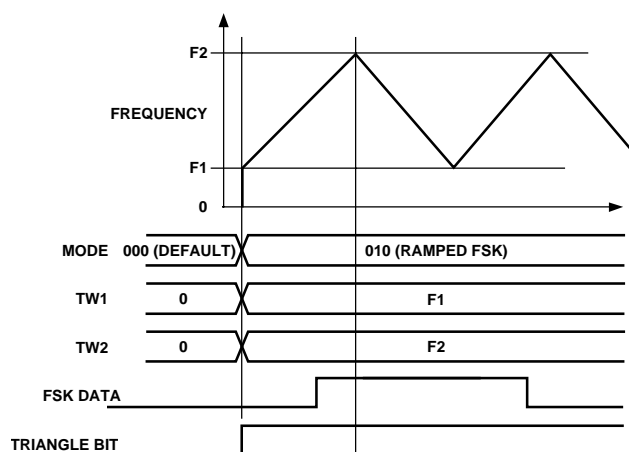

Figure 38. Automatic Linear Ramping Using the Triangle Bit

Additional flexibility in the ramped FSK mode is provided by the AD9852's ability to respond to changes in the 48-bit delta frequency word and/or the 20-bit ramp rate counter at any time during the ramping from F1 to F2 or vice versa. To create these nonlinear frequency changes, it is necessary to combine several linear ramps with different slopes in a piecewise fashion. This is done by programming and executing a linear ramp at a rate or slope and then altering the slope (by changing the ramp rate clock or delta frequency word, or both). Changes in slope can be made as often as needed before the destination frequency has been reached to form the desired nonlinear frequency sweep response. These piecewise changes can be precisely timed using the 32-bit internal update clock (see the Internal and External Update Clock section).

Nonlinear ramped FSK has the appearance of the chirp function shown in Figure 41. The major difference between a ramped FSK function and a chirp function is that FSK is limited to operation between F1 and F2, whereas chirp operation has no F2 limit frequency.

Two additional control bits (CLR ACC1 and CLR ACC2) are available in the ramped FSK mode that allow more options. Setting CLR ACC1 (Register Address 1F hex) high clears the 48-bit frequency accumulator (ACC1) output with a retriggerable one-shot pulse of one system clock duration. If the CLR ACC1 bit is left high, a one-shot pulse is delivered on the rising edge of every update clock. The effect is to interrupt the current ramp, reset the frequency to the start point (F1 or F2), and then continue to ramp up (or down) at the previous rate. This occurs

even when a static F1 or F2 destination frequency has been achieved.

Alternatively, the CLR ACC2 control bit (Register Address 1F hex) can be used to clear both the frequency accumulator (ACC1) and the phase accumulator (ACC2). When this bit is set high, the output of the phase accumulator results in 0 Hz output from the DDS. As long as this bit is set high, the frequency and phase accumulators are cleared, resulting in 0 Hz output. To return to previous DDS operation, CLR ACC2 must be set to logic low.

## CHIRP (MODE 011)

Chirp mode is also known as pulsed FM. Most chirp systems use a linear FM sweep pattern, but the AD9852 can also support nonlinear patterns. In radar applications, use of chirp or pulsed FM allows operators to significantly reduce the output power needed to achieve the same result a single frequency radar system produces. Figure 41 represents a very low resolution nonlinear chirp that demonstrates the different slopes created by varying the time steps (ramp rate) and frequency steps (delta frequency word).

The AD9852 permits precise, internally generated linear, or externally programmed nonlinear, pulsed or continuous FM over the complete frequency range, duration, frequency resolution, and sweep direction(s). All of these options are user programmable. A block diagram of the FM chirp components is shown in Figure 40.

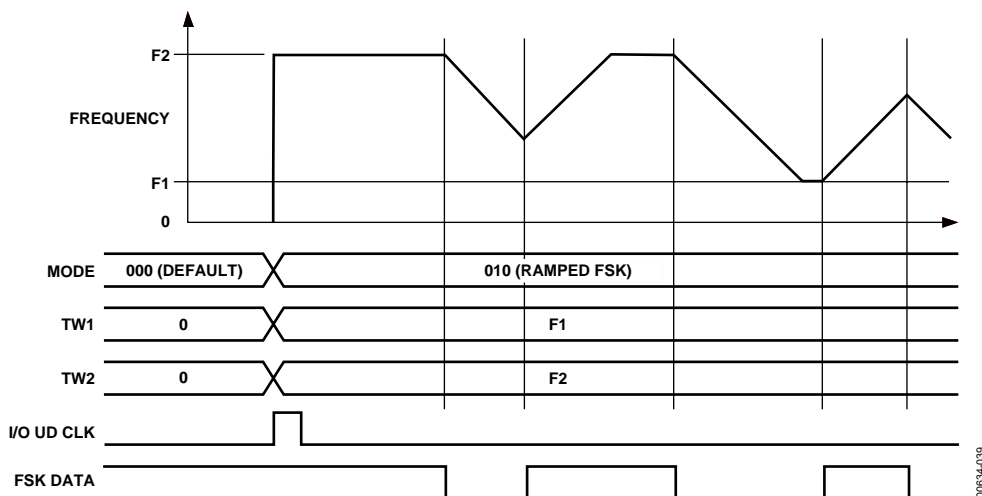

Figure 39. Effect of Premature Ramped FSK Data

00834-039

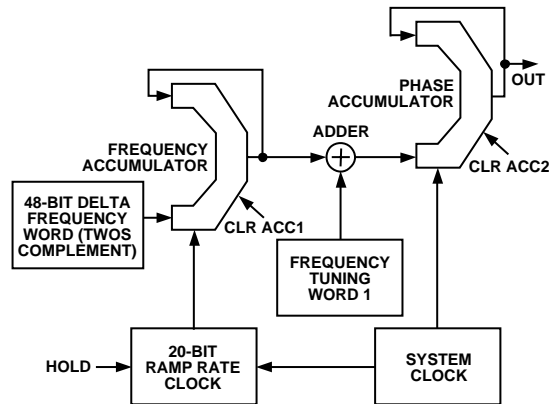

Figure 40. FM Chirp Components

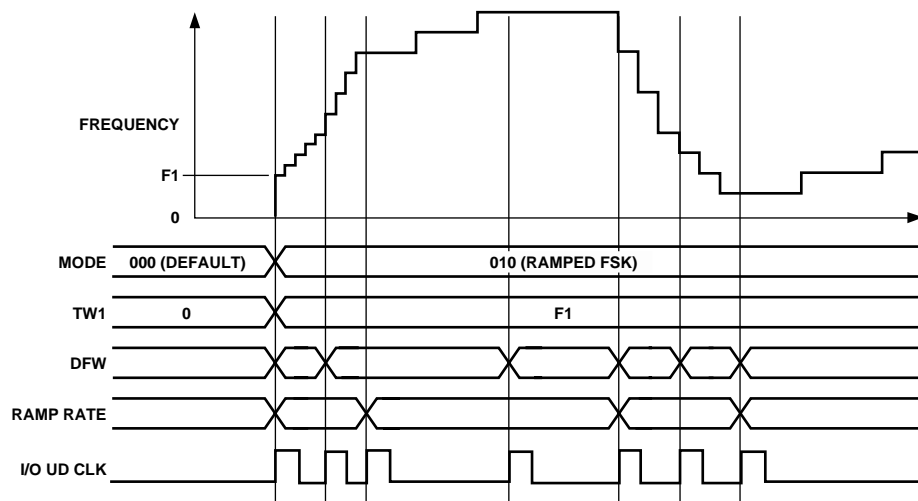

Figure 41. Example of a Nonlinear Chirp

### Basic FM Chirp Programming Steps

1. Program a start frequency into Frequency Tuning Word 1 (Parallel Register Address 4 hex to Parallel Register Address 9 hex), hereafter called FTW1.
2. Program the frequency step resolution into the 48-bit, twos complement delta frequency word (Parallel Register Address 10 hex to Parallel Register Address 15 hex).
3. Program the rate of change (time at each frequency) into the 20-bit ramp rate clock (Parallel Register Address 1A hex to Parallel Register Address 1C hex).

When programming is complete, an I/O update pulse at Pin 20 engages the program commands.

The necessity for a twos complement delta frequency word is to define the direction in which the FM chirp moves. If the 48-bit delta frequency word is negative (MSB is high), the incremental frequency changes are in a negative direction from FTW1. If the 48-bit word is positive (MSB is low), the incremental frequency changes are in a positive direction from FTW1.

It is important to note that FTW1 is only a starting point for FM chirp. There is no built-in restraint requiring a return to FTW1. Once the FM chirp begins, it is free to move (under program control) within the Nyquist bandwidth (dc to one-half the system clock). However, instant return to FTW1 can be easily achieved.

Two control bits (CLR ACC1 and CLR ACC2) are available in the FM chirp mode that allow the device to return to the beginning frequency, FTW1, or to 0 Hz. When the CLR ACC1 bit (Register Address 1F hex) is set high, the 48-bit frequency accumulator (ACC1) output is cleared with a retriggerable one-shot pulse of one system clock duration. The 48-bit delta frequency word input to the accumulator is unaffected by the CLR ACC1 bit. If the CLR ACC1 bit is held high, a one-shot pulse is delivered to the frequency accumulator (ACC1) on every rising edge of the I/O update clock. The effect is to interrupt the current chirp, reset the frequency to that programmed into FTW1, and continue the chirp at the previously programmed rate and direction. Figure 42 shows clearing of the frequency accumulator output in chirp mode. Shown in the diagram is the I/O update clock, which is either user

supplied or internally generated. See the Internal and External Update Clock section for a discussion of the I/O update.

Alternatively, the CLR ACC2 control bit (Register Address 1F hex) is available to clear both the frequency accumulator (ACC1) and the phase accumulator (ACC2). When this bit is set high, the output of the phase accumulator results in 0 Hz output from the DDS. As long as this bit is set high, the frequency and phase accumulators are cleared, resulting in 0 Hz output. To return to the previous DDS operation, CLR ACC2 must be set to logic low. This bit is useful for generating pulsed FM.

Figure 43 graphically illustrates the effect of the CLR ACC2 bit on the DDS output frequency. Reprogramming the registers while the CLR ACC2 bit is high allows a new FTW1 frequency and slope to be loaded.

Another function only available in the chirp mode is the HOLD pin (Pin 29). This function stops the clock signal to the ramp rate counter, thereby halting any further clocking pulses to the frequency accumulator, ACC1.

The effect is to halt the chirp at the frequency existing just before the HOLD pin is pulled high. When the HOLD pin is returned low, the clock resumes and chirp continues. During a hold condition, the user can change the programming registers; however, the ramp rate counter must resume operation at its previous rate until a count of 0 is obtained before a new ramp rate count can be loaded. Figure 44 illustrates the effect of the hold function on the DDS output frequency.

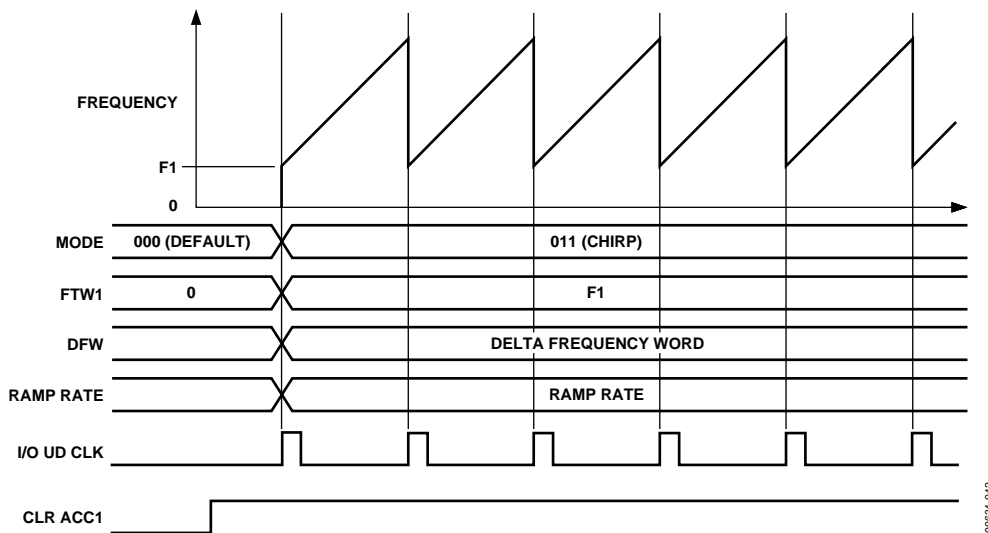

Figure 42. Effect of CLR ACC1 in FM Chirp Mode

00834-042



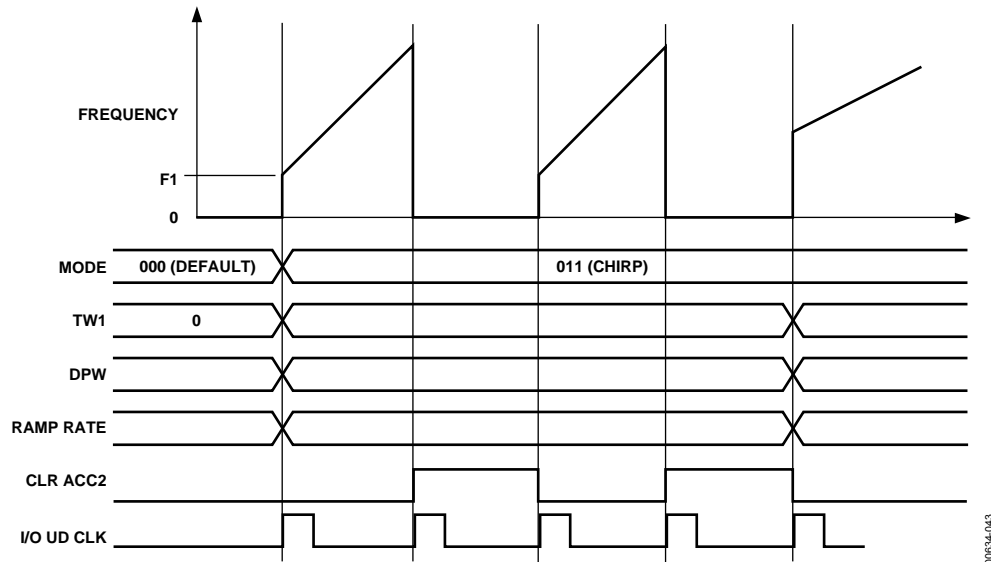

Figure 43. Effect of CLR ACC2 in FM Chirp Mode

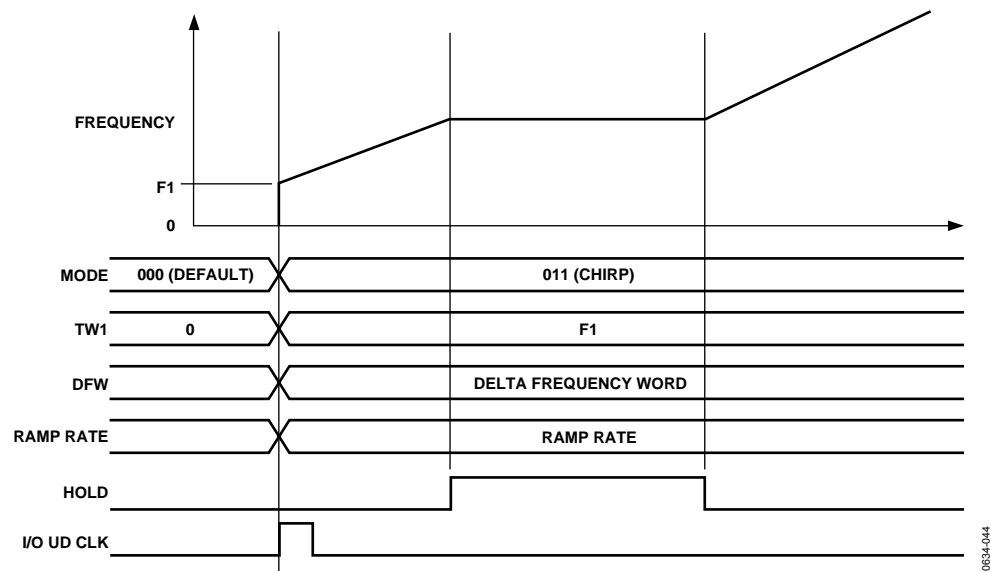

Figure 44. Example of Hold Function

The 32-bit automatic I/O update counter can be used to construct complex chirp or ramped FSK sequences. Because this internal counter is synchronized with the AD9852 system clock, it allows precisely timed program changes to be invoked. For such changes, the user need only reprogram the desired registers before the automatic I/O update clock is generated.

In chirp mode, the destination frequency is not directly specified. If the user fails to control the chirp, the DDS automatically confines itself to the frequency range between dc and Nyquist. Unless terminated by the user, the chirp continues until power is removed.

When the chirp destination frequency is reached, the user can choose any of the following actions:

- Stop at the destination frequency either by using the HOLD pin or by loading all 0s into the delta frequency word registers of the frequency accumulator (ACC1).
- Use the HOLD pin function to stop the chirp, and then ramp down the output amplitude either by using the digital multiplier stages and the output shaped keying pin (Pin 30) or by using the program register control (Address 21 hex to Address 24 hex).
- Abruptly end the transmission with the CLR ACC2 bit.

- Continue chirp by reversing the direction and returning to the previous or another destination frequency in a linear or user-directed manner. If this involves reducing the frequency, a negative 48-bit delta frequency word (the MSB is set to 1) must be loaded into Register 10 hex to Register 15 hex. Any decreasing frequency step of the delta frequency word requires the MSB to be set to logic high.
- Continue chirp by immediately returning to the beginning frequency (F1) in a sawtooth fashion, and then repeating the previous chirp process. In this case, an automatic repeating chirp can be set up by using the 32-bit update clock to issue the CLR ACC1 command at precise time intervals. Adjusting the timing intervals or changing the delta frequency word changes the chirp range. It is incumbent upon the user to balance the chirp duration and frequency resolution to achieve the proper frequency range.

## BPSK (MODE 100)

Binary, biphasic, or bipolar phase shift keying is a means to rapidly select between two preprogrammed 14-bit output phase offsets. The logic state of BPSK (Pin 29) controls the selection of Phase Adjust Register 1 or Phase Adjust Register 2. When low, BPSK selects Phase Adjust Register 1; when high, it selects Phase Adjust Register 2. Figure 45 illustrates phase changes made to four cycles of an output carrier.

### Basic BPSK Programming Steps

1. Program a carrier frequency into Frequency Tuning Word 1.
2. Program the appropriate 14-bit phase words into Phase Adjust Register 1 and Phase Adjust Register 2.
3. Attach the BPSK data source to Pin 29.
4. Activate the I/O update clock when ready.

If higher-order PSK modulation is desired, the user can select single-tone mode and program Phase Adjust Register 1 using the serial or high speed parallel programming bus.

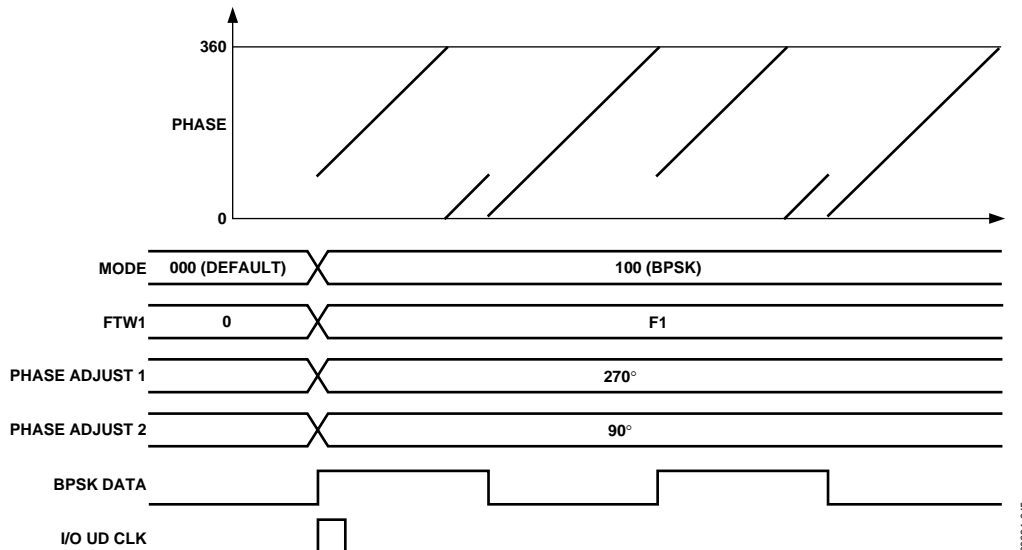

Figure 45. BPSK Mode

## USING THE AD9852

### INTERNAL AND EXTERNAL UPDATE CLOCK

The update clock function is composed of a bidirectional I/O pin (Pin 20) and a programmable 32-bit down-counter. In order for programming changes to be transferred from the I/O buffer registers to the active core of the DDS, a clock signal (low-to-high edge) must be externally supplied to Pin 20 or internally generated by the 32-bit update clock.

When the user provides an external update clock, it is internally synchronized with the system clock to prevent partial transfer of program register information due to violation of data setup or hold times. This mode provides the user with complete control of when updated program information becomes effective. The default mode for the update clock is internal (internal/external update clock control register bit is logic high). To switch to external update clock mode, the internal/external update clock control register bit must be set to logic low. The internal update mode generates automatic, periodic update pulses at intervals set by the user.

An internally generated update clock can be established by programming the 32-bit update clock registers (Address 16 hex to Address 19 hex) and setting the internal/external update clock control register bit (Address 1F hex) to logic high. The update clock countdown counter function operates at half the rate of the system clock (150 MHz maximum) and counts down from a 32-bit binary value (programmed by the user). When the count reaches 0, an automatic I/O update of the DDS output or the DDS functions is generated. The update clock is internally and externally routed to Pin 20 to allow users to synchronize the programming of update information with the update clock rate. The time between update pulses is given as

$$(N + 1)(\text{System Clock Period} \times 2)$$

where  $N$  is the 32-bit value programmed by the user, and the allowable range of  $N$  is from 1 to  $(2^{32} - 1)$ .

The internally generated update pulse output on Pin 20 has a fixed high time of eight system clock cycles.

Programming the update clock register for values less than 5 causes the I/O UD CLK pin to remain high. Although the update clock can still function in this state, it cannot be used to indicate when data is transferring. This is an effect of the minimum high pulse time when I/O UD CLK functions as an output.

### ON/OFF OUTPUT SHAPED KEYING (OSK)

The on/off OSK feature allows the user to control the amplitude vs. time slope of the cosine DAC output signal. This function is used in burst transmissions of digital data to reduce the adverse spectral impact of short, abrupt bursts of data. Users must first enable the digital multiplier by setting the OSK EN bit (Control Register Address 20 hex) to logic high in the control register. Otherwise, if the OSK EN bit is set low, the digital multiplier responsible for amplitude control is bypassed, and the cosine DAC output is set to full-scale amplitude.

In addition to setting the OSK EN bit, a second control bit, OSK INT (also at Address 20 hex), must be set to logic high. Logic high selects the linear internal control of the output ramp-up or ramp-down function. A logic low in the OSK INT bit switches control of the digital multiplier to a user-programmable 12-bit register, allowing users to dynamically shape the amplitude transition in practically any fashion. The 12-bit register, labeled output shape key, is located at Address 21 hex to Address 22 hex, as indicated in Table 9. The maximum output amplitude is a function of the  $R_{SET}$  resistor and is not programmable when OSK INT is enabled.

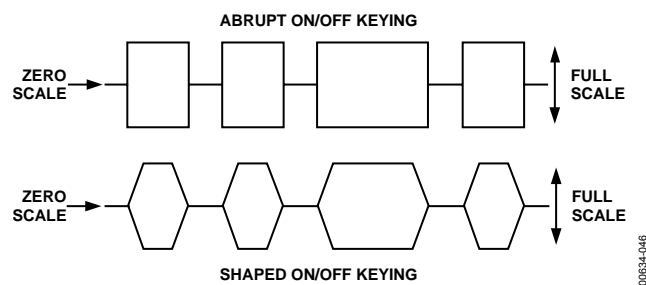

Figure 46. On/Off Output Shaped Keying

The transition time from zero scale to full scale must also be programmed. The transition time is a function of two fixed elements and one variable. The variable element is the programmable 8-bit ramp rate counter. This is a countdown counter that is clocked at the system clock rate (300 MHz maximum) and generates one pulse whenever the counter reaches 0. This pulse is routed to a 12-bit counter that increments with each pulse received. The outputs of the 12-bit counter are connected to the 12-bit digital multiplier. When the digital multiplier has a value of all 0s at its inputs, the input signal is multiplied by 0, producing zero scale. When the multiplier has a value of all 1s, the input signal is multiplied by a value of 4095 or 4096, producing nearly full scale. There are 4094 remaining fractional multiplier values that produce output amplitudes scaled according to their binary values.

# AD9852

The two fixed elements of the transition time are the period of the system clock (which drives the ramp rate counter) and the number of amplitude steps (4096). For example, if the system clock of the AD9852 is 100 MHz (10 ns period) and the ramp rate counter is programmed for a minimum count of 3, two system clock periods are required: one rising edge loads the countdown value, and the next edge decrements the counter from 3 to 2. If the countdown value is less than 3, the ramp rate counter stalls and therefore produces a constant scaling value to the digital multiplier. This stall condition may have an application for the user.

The relationship of the 8-bit countdown value to the time between output pulses is given as

$$(N + 1) \times \text{System Clock Period}$$

where  $N$  is the 8-bit countdown value.

A total of 4096 output pulses is required to advance the 12-bit up-counter from zero scale to full scale. Therefore, the minimum output shaped keying ramp time for a 100 MHz system clock is

$$4096 \times 4 \times 10 \text{ ns} \approx 164 \mu\text{s}$$

The maximum ramp time is

$$4096 \times 256 \times 10 \text{ ns} \approx 10.5 \text{ ms}$$

Finally, by changing the logic state of Pin 30, output shaped keying automatically performs the programmed output envelope functions when OSK INT is high. A logic high on Pin 30 causes the outputs to linearly ramp up to full-scale amplitude and hold until the logic level is changed to low, causing the outputs to ramp down to zero scale.

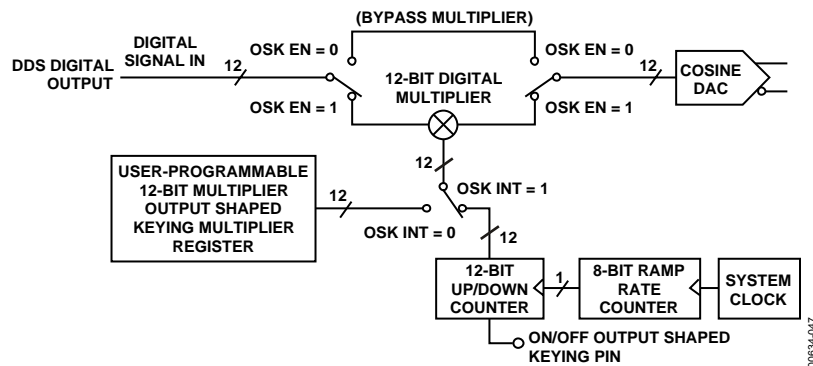

Figure 47. Block Diagram of the Digital Multiplier Section Responsible for the Output Shaped Keying Function

## COSINE DAC

The cosine output of the DDS drives the cosine DAC (300 MSPS maximum). Its maximum output amplitude is set by the DAC  $R_{SET}$  resistor at Pin 56. This is a current-output DAC with a full-scale maximum output of 20 mA; however, a nominal 10 mA output current provides best spurious-free dynamic range (SFDR) performance. The value of  $R_{SET}$  is  $39.93/I_{OUT}$ , where  $I_{OUT}$  is expressed in amps. DAC output compliance specifications limit the maximum voltage developed at the outputs to  $-0.5$  V to  $+1$  V. Voltages developed beyond this limitation cause excessive DAC distortion and possibly permanent damage. The user must choose a proper load impedance to limit the output voltage swing to the compliance limits. Both DAC outputs should be terminated equally for best SFDR, especially at higher output frequencies, where harmonic distortion errors are more prominent.

The cosine DAC is preceded by an inverse  $\sin(x)/x$  filter (also called an inverse sinc filter) that precompensates for DAC output amplitude variations over frequency to achieve flat amplitude response from dc to Nyquist. This DAC can be powered down when not needed by setting the DAC PD bit high (Address 1D hex of the control register). Cosine DAC outputs are designated as  $I_{OUT1}$  (Pin 48) and  $\overline{I_{OUT1}}$  (Pin 49).

## CONTROL DAC

The control DAC output can provide dc control levels to external circuitry, generate ac signals, or enable duty cycle control of the on-board comparator. The input to the control DAC is configured to accept twos complement data supplied by the user. Data is channeled through the serial or parallel interface to the 12-bit control DAC register (Address 26 hex and Address 27 hex) at a maximum data rate of 100 MHz. This DAC is clocked at the system clock, 300 MSPS (maximum), and has the same maximum output current capability as that of the cosine DAC. The single  $R_{SET}$  resistor on the AD9852 sets the full-scale output current for both DACs. When not needed, the control DAC can be powered down separately to conserve power by setting the control DAC power-down bit high (Address 1D hex). Control DAC outputs are designated as  $I_{OUT2}$  (Pin 52) and  $\overline{I_{OUT2}}$  (Pin 51).

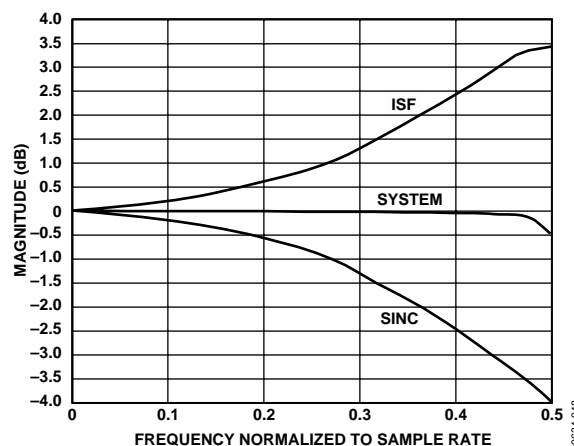

Figure 48. Inverse Sinc Filter Response

## INVERSE SINC FUNCTION

This filter precompensates input data to the cosine DAC for the  $\sin(x)/x$  roll-off characteristic inherent in the DAC's output spectrum. This allows wide bandwidth signals, such as QPSK, to be output from the DAC without appreciable amplitude variations as a function of frequency. The inverse sinc function can be bypassed to significantly reduce power consumption, especially at higher clock speeds.

Inverse sinc is engaged by default and is bypassed by bringing the bypass inverse sinc bit high in Control Register 20 hex, as noted in Table 9.

## REFCLK MULTIPLIER

The REFCLK multiplier is a programmable PLL-based reference clock multiplier that allows the user to select an integer clock multiplying value over the range of  $4\times$  to  $20\times$ . Use of this function allows users to input as little as 15 MHz at the REFCLK input to produce a 300 MHz internal system clock. Five bits in Control Register 1E hex set the multiplier value, as described in Table 8.

The REFCLK multiplier function can be bypassed to allow direct clocking of the AD9852 from an external clock source. The system clock for the AD9852 is either the output of the REFCLK multiplier (if it is engaged) or the REFCLK inputs. REFCLK can be either a single-ended or differential input by setting Pin 64 (DIFF CLK ENABLE) low or high, respectively.

## PLL Range Bit

The PLL range bit selects the frequency range of the REFCLK multiplier PLL. For operation from 200 MHz to 300 MHz (internal system clock rate), the PLL range bit should be set to Logic 1. For operation below 200 MHz, set the PLL range bit to Logic 0. The PLL range bit adjusts the PLL loop parameters for optimized phase noise performance within each range.

## **PLL Filter**

The PLL FILTER pin (Pin 61) provides the connection for the external zero-compensation network of the PLL loop filter. The zero-compensation network consists of a 1.3 k $\Omega$  resistor in series with a 0.01  $\mu$ F capacitor. The other side of the network should be connected as close as possible to Pin 60 (AVDD). For optimum phase noise performance, the clock multiplier can be bypassed by setting the bypass PLL bit in Control Register Address 1E hex.

## **Differential REFCLK Enable**

A high level on the DIFF CLK ENABLE pin enables the differential clock inputs, REFCLK (Pin 69) and  $\overline{\text{REFCLK}}$  (Pin 68). The minimum differential signal amplitude required is 400 mV p-p at the REFCLK input pins. The center point or common-mode range of the differential signal can range from 1.6 V to 1.9 V.

When Pin 64 (DIFF CLK ENABLE) is tied low, REFCLK (Pin 69) is the only active clock input. This is referred to as single-ended mode. In this mode, Pin 68 ( $\overline{\text{REFCLK}}$ ) should be tied low or high.

## **HIGH SPEED COMPARATOR**

The comparator is optimized for high speed and has a toggle rate greater than 300 MHz, low jitter, sensitive input, and built-in hysteresis. It also has an output level of 1 V p-p minimum into

50  $\Omega$  or CMOS logic levels into high impedance loads. The comparator can be powered down separately to conserve power. This comparator is used in clock-generator applications to square up the filtered sine wave generated by the DDS.

## **POWER-DOWN**

The programming registers allow several individual stages to be powered down to reduce power consumption while maintaining the functionality of the desired stages. These stages are identified in the Register Layout table (Table 9) in the Address 1D hex section. Power-down is achieved by setting the specified bits to logic high. A logic low indicates that the stages are powered up.

Furthermore, and perhaps most importantly, the inverse sinc filters and the digital multiplier stages can be bypassed to achieve significant power reduction by programming the control registers in Address 20 hex. Again, logic high causes the stage to be bypassed. Of particular importance is the inverse sinc filter because this stage consumes a significant amount of power.

A full power-down occurs when all four PD bits in Control Register 1D hex are set to logic high. This reduces power consumption to approximately 10 mW (3 mA).

## PROGRAMMING THE AD9852

The AD9852 Register Layout table (Table 9) contains information for programming a chip for a desired functionality. Although many applications require very little programming to configure the AD9852, some use all 12 accessible register banks. The AD9852 supports an 8-bit parallel I/O operation or an SPI-compatible serial I/O operation. All accessible registers can be written and read back in either I/O operating mode.

S/P SELECT (Pin 70) is used to configure the I/O mode. Systems that use a parallel I/O mode must connect the S/P SELECT pin to  $V_{DD}$ . Systems that operate in the serial I/O mode must tie the S/P SELECT pin to GND.

Regardless of the mode, the I/O port data is written to a buffer memory that only affects operation of the part after the contents of the buffer memory are transferred to the register banks. This transfer of information occurs synchronous to the system clock in one of two ways:

- The transfer is internally controlled at a rate programmed by the user.
- The transfer is externally controlled by the user. I/O operations can occur in the absence of REFCLK, but data cannot be moved from the buffer memory to the register bank without REFCLK. (See the Internal and External Update Clock section for details.)

### MASTER RESET

The MASTER RESET pin must be held at logic high active for a minimum of 10 system clock cycles. This initializes the communication bus and loads the default values listed in Table 9.

### PARALLEL I/O OPERATION

With the S/P SELECT pin tied high, the parallel I/O mode is active. The I/O port is compatible with industry-standard DSPs and microcontrollers. Six address bits, eight bidirectional data bits, and separate write/read control inputs comprise the I/O port pins.

Parallel I/O operation allows write access to each byte of any register in a single I/O operation of up to one per 10.5 ns. Readback capability for each register is included to ease designing with the AD9852.

Reads are not guaranteed at 100 MHz, because they are intended for software debugging only.

Parallel I/O operation timing diagrams are shown in Figure 49 and Figure 50.

**Table 8. REFCLK Multiplier Control Register Values**

Multiplier Value	Reference Multiplier				
	Bit 4	Bit 3	Bit 2	Bit 1	Bit 0
4	0	0	1	0	0
5	0	0	1	0	1
6	0	0	1	1	0
7	0	0	1	1	1
8	0	1	0	0	0
9	0	1	0	0	1
10	0	1	0	1	0
11	0	1	0	1	1
12	0	1	1	0	0
13	0	1	1	0	1
14	0	1	1	1	0
15	0	1	1	1	1
16	1	0	0	0	0
17	1	0	0	0	1
18	1	0	0	1	0
19	1	0	0	1	1
20	1	0	1	0	0

### SERIAL PORT I/O OPERATION

With the S/P SELECT pin tied low, the serial I/O mode is active. The AD9852 serial port is a flexible, synchronous, serial communication port, allowing easy interface to many industry-standard microcontrollers and microprocessors. The serial I/O is compatible with most synchronous transfer formats, including both the Motorola 6905/11 SPI and Intel 8051 SSR protocols. The interface allows read/write access to all 12 registers that configure the AD9852 and can be configured as a single-pin I/O (SDIO) or two unidirectional pins for input and output (SDIO/SDO). Data transfers are supported in MSB- or LSB-first format at up to 10 MHz.

When configured for serial I/O operation, most pins from the AD9852 parallel port are inactive; only some pins are used for serial I/O operation. Table 10 describes pin requirements for serial I/O operation.

When operating the device in the serial I/O mode, it is best to use the external I/O update clock mode to avoid an I/O update clock occurring during a serial communication cycle. Such an occurrence may cause incorrect programming due to a partial data transfer. Therefore, users should write to the device between I/O update clocks. To exit the default internal update mode, program the device for external update operation at power-up before starting the REFCLK signal but after a master reset. Starting the REFCLK causes this information to transfer to the register bank, forcing the device to switch to external update mode.

# AD9852

Table 9. Register Layout<sup>1</sup>

Parallel Address (Hex)	Serial Address (Hex)	AD9852 Register Layout								Default Value (Hex)	
		Bit 7	Bit 6	Bit 5	Bit 4	Bit 3	Bit 2	Bit 1	Bit 0		
00	0	Phase Adjust Register 1 <13:8> (Bits 15, 14 don't care)					Phase 1				00
01		Phase Adjust Register 1 <7:0>									00
02	1	Phase Adjust Register 2 <13:8> (Bits 15, 14 don't care)					Phase 2				00
03		Phase Adjust Register 2 <7:0>									00
04	2	Frequency Tuning Word 1 <47:40>					Frequency 1				00
05		Frequency Tuning Word 1 <39:32>									00
06		Frequency Tuning Word 1 <31:24>									00
07		Frequency Tuning Word 1 <23:16>									00
08		Frequency Tuning Word 1 <15:8>									00
09		Frequency Tuning Word 1 <7:0>									00
0A	3	Frequency Tuning Word 2 <47:40>					Frequency 2				00
0B		Frequency Tuning Word 2 <39:32>									00
0C		Frequency Tuning Word 2 <31:24>									00
0D		Frequency Tuning Word 2 <23:16>									00
0E		Frequency Tuning Word 2 <15:8>									00
0F		Frequency Tuning Word 2 <7:0>									00
10		Delta frequency word <47:40>								00	
11		Delta frequency word <39:32>								00	
12		Delta frequency word <31:24>								00	
13		Delta frequency word <23:16>								00	
14		Delta frequency word <15:8>								00	
15		Delta frequency word <7:0>								00	
16	5	Update clock <31:24>								00	
17		Update clock <23:16>								00	
18		Update clock <15:8>								00	
19		Update clock <7:0>								00	
1A	6	Ramp rate clock <19:16> (Bits 23, 22, 21, 20, don't care)								00	
1B		Ramp rate clock <15:8>								00	
1C		Ramp rate clock <7:0>								00	
1D	7	Don't care	Don't care	Don't care	Comp PD	Reserved, always low	Control DAC PD	DAC PD	DIG PD	10	
1E		Don't care	PLL range	Bypass PLL	Ref Mult 4	Ref Mult 3	Ref Mult 2	Ref Mult 1	Ref Mult 0	64	
1F		CLR ACC1	CLR ACC2	Triangle	Don't care	Mode 2	Mode 1	Mode 0	Int/Ext update clock	01	
20		Don't care	Bypass inv sinc	OSK EN	OSK INT	Don't care	Don't care	LSB first	SDO active CR [0]	20	
21	8	Output shaped keying multiplier <11:8> (Bits 15, 14, 13, 12 don't care)								00	
22		Output shaped keying multiplier <7:0>								00	
23	9	Don't care								00	
24		Don't care								00	
25	A	Output shaped keying ramp rate <7:0>								80	
26	B	Control DAC <11:8> (Bits 15, 14, 13, 12 don't care)								00	
27		Control DAC <7:0> (Data is required to be in twos complement format)								00	

<sup>1</sup> The shaded sections comprise the control register.



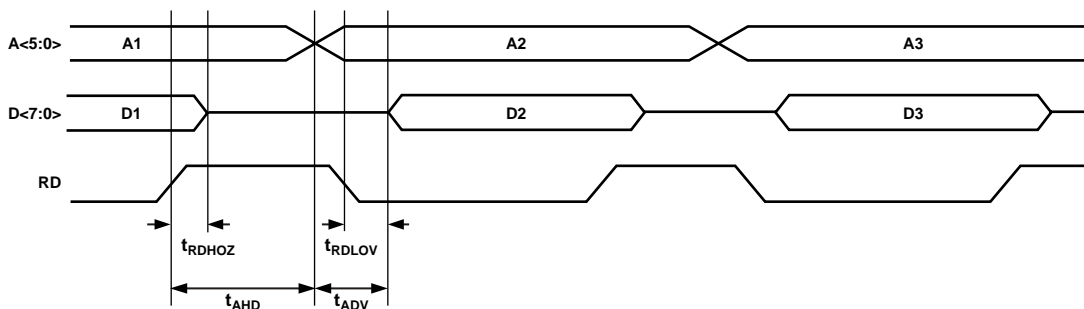

SPECIFICATION	VALUE	DESCRIPTION
$t_{ADV}$	15ns	ADDRESS TO DATA VALID TIME (MAXIMUM)
$t_{AHD}$	5ns	ADDRESS HOLD TIME TO RD SIGNAL INACTIVE (MINIMUM)
$t_{RDLOV}$	15ns	RD LOW TO OUTPUT VALID (MAXIMUM)
$t_{RDHOZ}$	10ns	RD HIGH TO DATA THREE-STATE (MAXIMUM)

Figure 49. Parallel Port Read Timing Diagram

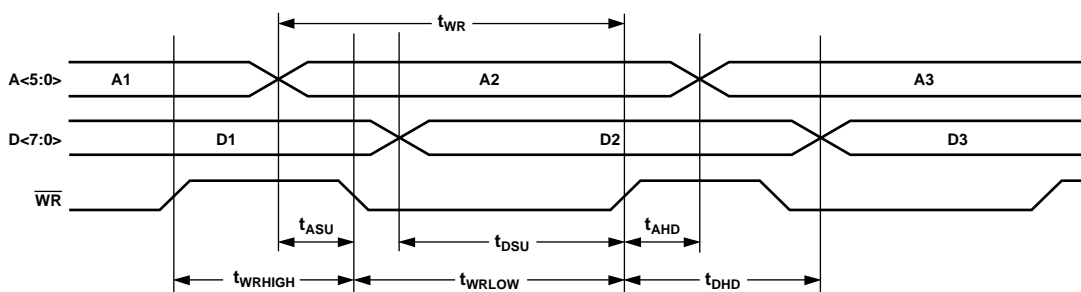

SPECIFICATION	VALUE	DESCRIPTION
$t_{ASU}$	8.0ns	ADDRESS SETUP TIME TO WR SIGNAL ACTIVE
$t_{DSU}$	3.0ns	DATA SETUP TIME TO WR SIGNAL ACTIVE
$t_{ADH}$	0ns	ADDRESS HOLD TIME TO WR SIGNAL INACTIVE
$t_{DHD}$	0ns	DATA HOLD TIME TO WR SIGNAL INACTIVE
$t_{WRLOW}$	2.5ns	WR SIGNAL MINIMUM LOW TIME
$t_{WRHIGH}$	7ns	WR SIGNAL MINIMUM HIGH TIME
$t_{WR}$	10.5ns	MINIMUM WRITE TIME

Figure 50. Parallel Port Write Timing Diagram

00634-049

00634-050

Table 10. Serial I/O Pin Requirements

Pin Number	Mnemonic	Serial I/O Description
1 to 8	D [7:0]	The parallel data pins are not active; tie these pins to VDD or GND.
14 to 16	A [5:3]	The A5, A4, and A3 parallel address pins are not active; tie these pins to VDD or GND.
17	A2/IO RESET	IO RESET.
18	A1/SDO	SDO.
19	A0/SDIO	SDIO.
20	I/O UD CLK	Update Clock. Same functionality for serial mode as parallel mode.
21	$\overline{WR}/SCLK$	SCLK.
22	$\overline{RD}/\overline{CS}$	$\overline{CS}$ —Chip Select.

## GENERAL OPERATION OF THE SERIAL INTERFACE

There are two phases of a serial communication cycle with the AD9852. Phase 1 is the instruction cycle, which is the writing of an instruction byte into the AD9852 coincident with the first eight SCLK rising edges. The instruction byte provides the AD9852 serial port controller with information regarding the data transfer cycle, which is Phase 2 of the communication cycle. The Phase 1 instruction byte defines whether the next data transfer is a read or write and the register address to be acted upon.

The first eight SCLK rising edges of each communication cycle are used to write the instruction byte into the AD9852. The remaining SCLK edges are for Phase 2 of the communication cycle. Phase 2 is the actual data transfer between the AD9852 and the system controller. The number of data bytes transferred during Phase 2 of the communication cycle is a function of the register address. The AD9852 internal serial I/O controller expects every byte of the register being accessed to be transferred. Table 11 describes how many bytes must be transferred.

**Table 11. Register Address vs. Data Bytes Transferred**

Serial Register Address	Register Name	Number of Bytes Transferred
0	Phase Offset Tuning Word Register 1	2
1	Phase Offset Tuning Word Register 2	2
2	Frequency Tuning Word 1	6
3	Frequency Tuning Word 2	6
4	Delta frequency register	6
5	Update clock rate register	4
6	Ramp rate clock register	3
7	Control register	4
8	Digital multiplier register	2
A	On/off output shaped keying ramp rate register	1
B	Control DAC register	2

At the completion of a communication cycle, the AD9852 serial port controller expects the subsequent eight rising SCLK edges to be the instruction byte of the next communication cycle. In addition, an active high input on the IO RESET pin immediately terminates the current communication cycle. After IO RESET returns low, the AD9852 serial port controller requires the subsequent eight rising SCLK edges to be the instruction byte of the next communication cycle.

All data input to the AD9852 is registered on the rising edge of SCLK, and all data is driven out of the AD9852 on the falling edge of SCLK.

Figure 51 and Figure 52 are useful in understanding the general operation of the AD9852 serial port.

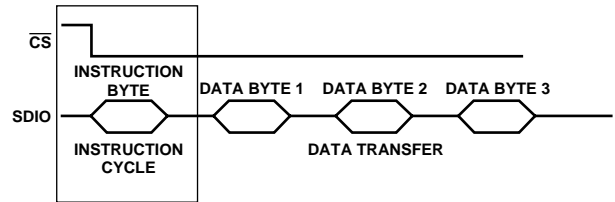

Figure 51. Using SDIO as a Read/Write Transfer

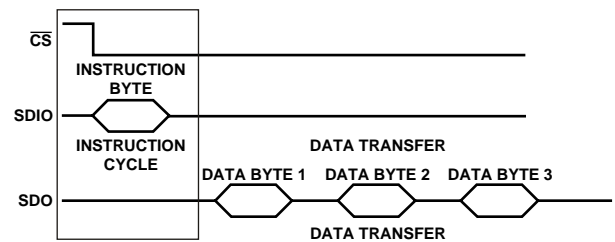

Figure 52. Using SDIO as an Input and SDO as an Output

### INSTRUCTION BYTE

The instruction byte contains the following information:

MSB				LSB			
D7	D6	D5	D4	D3	D2	D1	D0
R/W	X	X	X	A3	A2	A1	A0

$\overline{R/W}$ —Bit 7 of the instruction byte determines whether a read or write data transfer occurs following the instruction byte. Logic high indicates that a read operation will occur. Logic 0 indicates that a write operation will occur.

Bit 6, Bit 5, and Bit 4 of the instruction byte are dummy bits (don't care).

A3, A2, A1, A0—Bit 3, Bit 2, Bit 1, and Bit 0 of the instruction byte determine which register is accessed during the data transfer portion of the communication cycle (see Table 9 for register address details).

## SERIAL INTERFACE PORT PIN DESCRIPTIONS

Table 12.

Pin	Description
SCLK	Serial Clock (Pin 21). The serial clock pin is used to synchronize data to and from the AD9852 and to run the internal state machines. The SCLK maximum frequency is 10 MHz.
$\overline{CS}$	Chip Select (Pin 22). Active low input that allows more than one device on the same serial communication line. The SDO and SDIO pins go to a high impedance state when this input is high. If this pin is driven high during a communication cycle, the cycle is suspended until $\overline{CS}$ is reactivated low. The chip select pin can be tied low in systems that maintain control of SCLK.
SDIO	Serial Data I/O (Pin 19). Data is always written to the AD9852 on this pin. However, this pin can be used as a bidirectional data line. The configuration of this pin is controlled by Bit 0 of Register Address 20 hex. The default is Logic 0, which configures the SDIO pin as bidirectional.
SDO	Serial Data Out (Pin 18). Data is read from this pin for protocols that use separate lines for transmitting and receiving data. In the case where the AD9852 operates in a single bidirectional I/O mode, this pin does not output data and is set to a high impedance state.
IO RESET	Synchronize I/O Port (Pin 17). Synchronizes the I/O port state machines without affecting the contents of the addressable registers. An active high input on the IO RESET pin causes the current communication cycle to terminate. After the IO RESET pin returns low (Logic 0), another communication cycle can begin, starting with the instruction byte.

### Notes on Serial Port Operation

The AD9852 serial port configuration bits reside in Bit 1 and Bit 0 of Register Address 20 hex. The configuration changes immediately upon a valid I/O update. For multibyte transfers, writing to this register can occur during the middle of a communication cycle. Care must be taken to compensate for this new configuration during the remainder of the current communication cycle.

The system must maintain synchronization with the AD9852; otherwise, the internal control logic is not able to recognize further instructions. For example, if the system sends the instruction to write a 2-byte register and then pulses the SCLK pin for a 3-byte register (24 additional SCLK rising edges), communication synchronization is lost. In this case, the first 16 SCLK rising edges after the instruction cycle properly write the first two data bytes into the AD9852, but the subsequent eight rising SCLK edges are interpreted as the next instruction byte, not the final byte of the previous communication cycle.

In cases where synchronization is lost between the system and the AD9852, the IO RESET pin provides a means to re-establish synchronization without reinitializing the entire chip. Asserting the IO RESET pin (active high) resets the AD9852 serial port state machine, terminating the current I/O operation and forcing the device into a state in which the next eight SCLK rising edges are understood to be an instruction byte. The IO RESET pin must be deasserted (low) before the next instruction byte write can begin. Any information written to the AD9852 registers during a valid communication cycle prior to loss of synchronization remains intact.

### MSB/LSB TRANSFERS

The AD9852 serial port can support both MSB- and LSB-first data formats. This functionality is controlled by Bit 1 of Serial Register Bank 20 hex. When this bit is set active high, the AD9852 serial port is in LSB-first format. This bit defaults low, to the MSB-first format. The instruction byte must be written in the format indicated by Bit 1 of Serial Register Bank 20 hex. Therefore, if the AD9852 is in LSB-first mode, the instruction byte must be written from LSB to MSB.

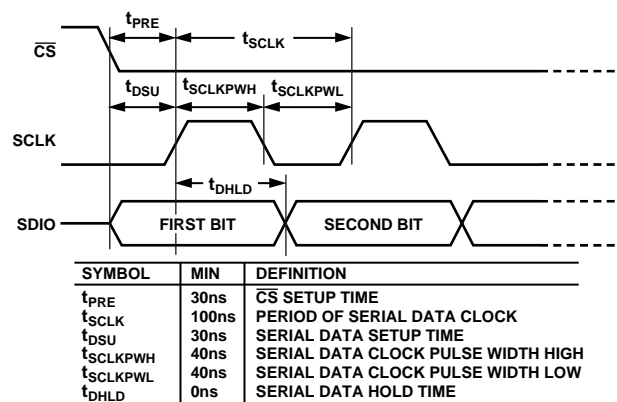

Figure 53. Timing Diagram for Data Write to AD9852

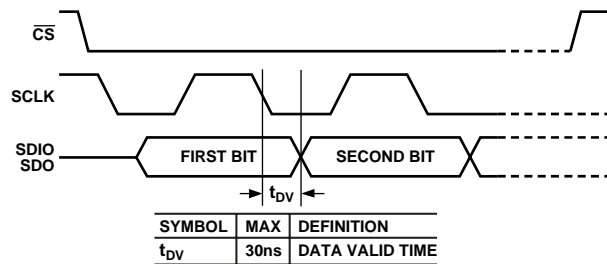

Figure 54. Timing Diagram for Read from AD9852

## CONTROL REGISTER DESCRIPTIONS

The control register is located at Address 1D hex to Address 20 hex (shown in the shaded portion of Table 9). It is composed of 32 bits. Bit 31 is located at the top left position, and Bit 0 is located in the lower right position of the shaded area of Table 9. The register has been subdivided into bits to make it easier to locate the information associated with specific control categories.

**Table 13. Control Register Bit Descriptions**

Bit	Description
CR [31:29]	Open.
CR [28]	The comparator power-down bit. When this bit is set to Logic 1, it indicates to the comparator that a power-down mode is active. This bit is an output of the digital section and is an input to the analog section.
CR [27]	Must always be written to Logic 0. Writing this bit to Logic 1 causes the AD9852 to stop functioning until a master reset is applied.
CR [26]	The control DAC power-down bit. When this bit is set to Logic 1, it indicates to the control DAC that power-down mode is active.
CR [25]	The full DAC power-down bit. When this bit is set to Logic 1, it indicates to both the cosine and control DACs, as well as the reference, that a power-down mode is active.
CR [24]	The digital power-down bit. When this bit is set to Logic 1, it indicates to the digital section that a power-down mode is active. Within the digital section, the clocks are forced to dc, effectively powering down the digital section. The PLL still accepts the REFCLK signal and continues to output the higher frequency.
CR [23]	Reserved. Write to 0.
CR [22]	The PLL range bit. The PLL range bit controls the VCO gain. The power-up state of the PLL range bit is Logic 1; a higher gain is required for frequencies greater than 200 MHz.
CR [21]	The bypass PLL bit, active high. When this bit is active, the PLL is powered down and the REFCLK input is used to drive the system clock signal. The power-up state of the bypass PLL bit is Logic 1 with PLL bypassed.
CR [20:16]	The PLL multiplier factor. These bits are the REFCLK multiplication factor unless the bypass PLL bit is set. The PLL multiplier valid range is from 4 to 20, inclusive.
CR [15]	The Clear Accumulator 1 bit. This bit has a one-shot type of function. When this bit is written active (Logic 1), a Clear Accumulator 1 signal is sent to the DDS logic, resetting the accumulator value to 0. The bit is then automatically reset, but the buffer memory is not reset. This bit allows the user to easily create a sawtooth frequency sweep pattern with minimal user intervention. This bit is intended for chirp mode only, but its function is still retained in other modes.
CR [14]	The clear accumulator bit. When this bit is active high, it holds both the Accumulator 1 and Accumulator 2 values at 0 for as long as the bit is active. This allows the DDS phase to be initialized via the I/O port.
CR [13]	The triangle bit. When this bit is set, the AD9852 automatically performs a continuous frequency sweep from F1 to F2 frequencies and back. The effect is a triangular frequency sweep. When this bit is set, the operating mode must be set to ramped FSK.
CR [12]	Don't care.
CR [11:9]	The three bits that describe the five operating modes of the AD9852: 0x0 = single-tone mode 0x1 = FSK mode 0x2 = ramped FSK mode 0x3 = chirp mode 0x4 = BPSK mode
CR [8]	The internal update active bit. When this bit is set to Logic 1, the I/O UD CLK pin is an output and the AD9852 generates the I/O UD CLK signal. When this bit is set to Logic 0, external I/O update function is performed, and the I/O UD CLK pin is configured as an input.
CR [7]	Reserved. Write to 0.
CR [6]	This is the inverse sinc filter bypass bit. When this bit is set, the data from the DDS block goes directly to the output shaped keying logic, and the clock for the inverse sinc filter is stopped. Default is clear with the filter enabled.
CR [5]	The output shaped keying enable bit. When this bit is set, the output ramping function is enabled and is performed in accordance with the CR [4] bit requirements.
CR [4]	The internal/external output shaped keying control bit. When this bit is set to Logic 1, the output shaped keying factor is internally generated and applied to the cosine DAC path. When this bit is cleared (default), the output shaped keying function is externally controlled by the user, and the output shaped keying factor is the value of the output shaped keying multiplier register. The two output shaped keying multiplier registers also default low so that the output is off at power-up until the device is programmed by the user.
CR [3:2]	Reserved. Write to 0.
CR [1]	The serial port MSB-/LSB-first bit. Defaults low, MSB first.
CR [0]	The serial port SDO active bit. Defaults low, inactive.

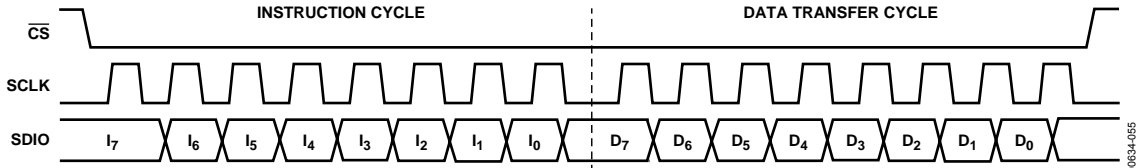

Figure 55. Serial Port Write Timing Clock Stall Low

00634-055

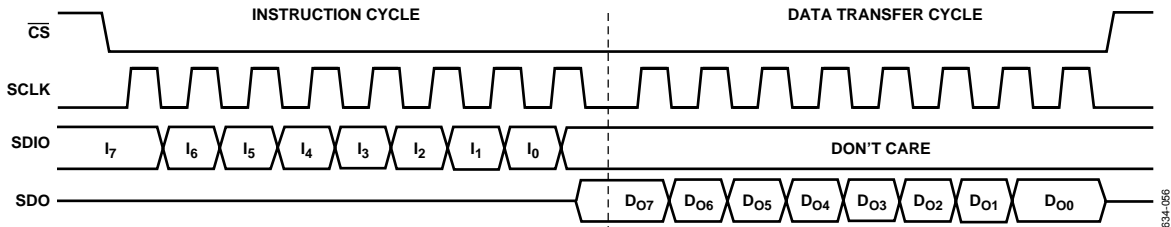

Figure 56. 3-Wire Serial Port Read Timing Clock Stall Low

00634-056

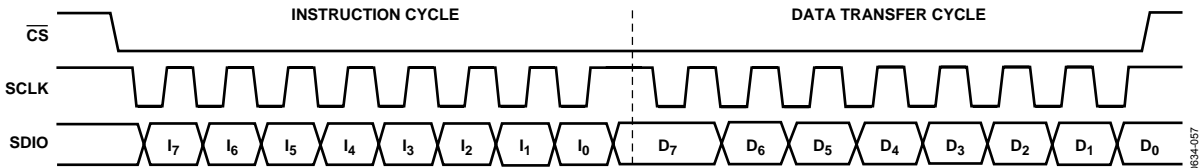

Figure 57. Serial Port Write Timing Clock Stall High

00634-057

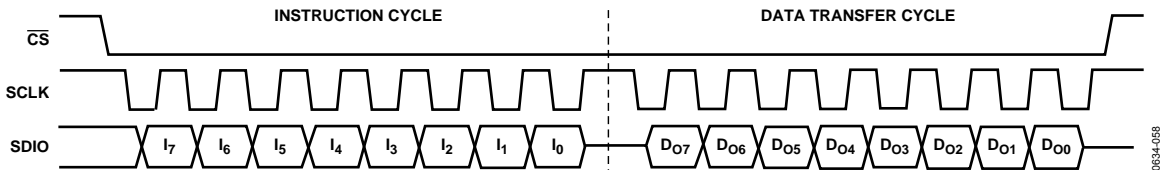

Figure 58. 2-Wire Serial Port Read Timing Clock Stall High

00634-058

## POWER DISSIPATION AND THERMAL CONSIDERATIONS

The AD9852 is a multifunctional, high speed device that targets a wide variety of synthesizer and agile clock applications. The numerous innovative features contained in the device each consume incremental power. If enabled in combination, the safe thermal operating conditions of the device may be exceeded. Careful analysis and consideration of power dissipation and thermal management is a critical element in the successful application of the AD9852 device.

The AD9852 device is specified to operate within the industrial temperature range of  $-40^{\circ}\text{C}$  to  $+85^{\circ}\text{C}$ . This specification is conditional, however, such that the absolute maximum junction temperature of  $150^{\circ}\text{C}$  is not exceeded. At high operating temperatures, extreme care must be taken when operating the device to avoid exceeding the junction temperature and potentially damaging the device.

Many variables contribute to the operating junction temperature within the device, including

- Package style
- Selected mode of operation
- Internal system clock speed
- Supply voltage
- Ambient temperature

The combination of these variables determines the junction temperature within the AD9852 device for a given set of operating conditions.

The AD9852 device is available in two package styles: a thermally enhanced surface-mount package with an exposed heat sink and a standard (nonthermally enhanced) surface-mount package. The thermal impedance of these packages is  $16^{\circ}\text{C}/\text{W}$  and  $38^{\circ}\text{C}/\text{W}$ , respectively, measured under still air conditions.

### THERMAL IMPEDANCE

The thermal impedance of a package can be thought of as a thermal resistor that exists between the semiconductor surface and the ambient air. The thermal impedance is determined by the package material and the physical dimensions of the package. The dissipation of the heat from the package is directly dependent on the ambient air conditions and the physical connection made between the IC package and the PCB.

Adequate dissipation of power from the AD9852 relies on all power and ground pins of the device being soldered directly to a copper plane on a PCB. In addition, the thermally enhanced package of the AD9852ASVZ has an exposed paddle on the bottom that must be soldered to a large copper plane, which, for convenience, can be the ground plane. Sockets for either package style of the AD9852 device are not recommended.

### JUNCTION TEMPERATURE CONSIDERATIONS

The power dissipation ( $P_{\text{DISS}}$ ) of the AD9852 device in a given application is determined by many operating conditions. Some of the conditions have a direct relationship with  $P_{\text{DISS}}$ , such as supply voltage and clock speed, but others are less deterministic. The total power dissipation within the device and its effect on the junction temperature must be considered when using the device. The junction temperature of the device is given by

$$\text{Junction Temperature} = (\text{Thermal Impedance} \times \text{Power Consumption}) + \text{Ambient Temperature}$$

The maximum ambient temperature combined with the maximum junction temperature establish the following power consumption limits for each package: 4.06 W for ASVZ models and 1.71 W for ASTZ models.

### Supply Voltage

Because  $P_{\text{DISS}} = V \times I$ , the supply voltage affects power dissipation and junction temperature. Users should design for 3.3 V nominally; however, the device is guaranteed to meet specifications over the full temperature range and over the supply voltage range of 3.135 V to 3.465 V.

### Clock Speed

Clock speed directly and linearly influences the total power dissipation of the device and therefore the junction temperature. As a rule, the user should select the lowest internal clock speed possible to support a given application to minimize power dissipation. Typically, the usable frequency output bandwidth from a DDS is limited to 40% of the clock rate to ensure that the requirements on the output low-pass filter are reasonable. For a typical DDS application, the system clock frequency should be 2.5 times the highest desired output frequency.

### Mode of Operation

The selected mode of operation for the AD9852 significantly influences the total power consumption. The AD9852 offers many features and modes, each of which imposes an additional power requirement. The available features make the AD9852 suitable for a variety of applications, but the device is designed to operate with only a few features enabled in a given application. Enabling multiple features at high clock speeds may result in exceeding the maximum junction temperature of the die and therefore severely limit the long-term reliability of the device. Figure 59 and Figure 60 show the power requirements associated with each feature of the AD9852. These charts should be used as a guide when determining how to optimize the AD9852 for reliable operation in a specific application.

Figure 59 shows the supply current consumed by the AD9852 over a range of frequencies for two possible configurations. All circuits enabled means that the output scaling multipliers, the

inverse sinc filter, both DACs, and the on-board comparator are enabled. Basic configuration means the output scaling multipliers, the inverse sinc filter, the control DAC, and the on-board comparator are disabled.

Figure 60 shows the approximate current consumed by each of the four functions.

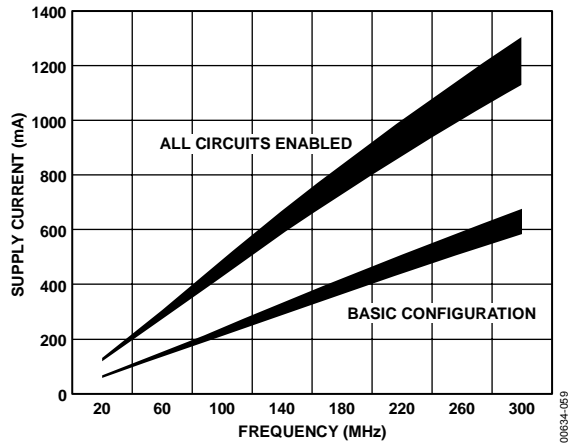

**NOTES**  
 THIS GRAPH ASSUMES THAT THE AD9852 DEVICE IS SOLDERED TO A MULTILAYER PCB PER THE RECOMMENDED BEST MANUFACTURING PRACTICES AND PROCEDURES FOR THE GIVEN PACKAGE TYPE.

Figure 59. Current Consumption vs. Clock Frequency

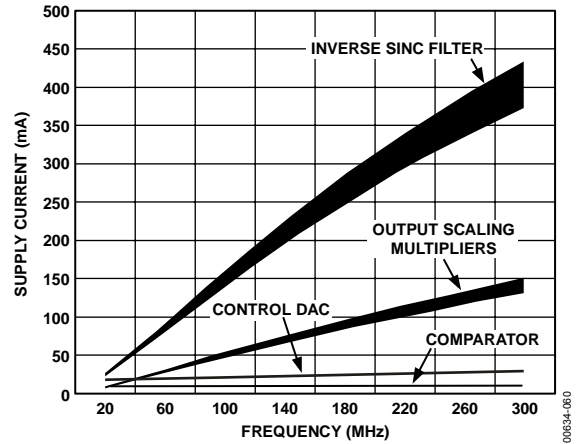

**NOTES**  
 THIS GRAPH ASSUMES THAT THE AD9852 DEVICE IS SOLDERED TO A MULTILAYER PCB PER THE RECOMMENDED BEST MANUFACTURING PRACTICES AND PROCEDURES FOR THE GIVEN PACKAGE TYPE.

Figure 60. Current Consumption by Function vs. Clock Frequency

## EVALUATION OF OPERATING CONDITIONS

The first step in applying the AD9852 is to select the internal clock frequency. Clock frequency selections greater than 200 MHz require use of the thermally enhanced package (AD9852ASVZ); clock frequency selections equal to or less than 200 MHz may allow use of the standard (nonthermally enhanced) plastic surface-mount package, but more information is needed to make this determination.

The second step is to determine the maximum required operating temperature for the AD9852 in a given application. Subtract this value from 150°C, which is the maximum junction temperature allowed for the AD9852. For the extended industrial temperature range, the maximum operating temperature is 85°C, which results in a difference of 65°C. This is the maximum temperature gradient the device can experience due to power dissipation.

The third step is to divide this maximum temperature gradient by the thermal impedance to determine the maximum power dissipation allowed for the application. For this example, 65°C divided by the thermal impedance of the package yields a total

power dissipation limit of 4.1 W and 1.7 W for the thermally and nonthermally enhanced packages, respectively. Therefore, for a 3.3 V nominal power supply voltage, the current consumed by the device under full operating conditions must not exceed 515 mA for the standard plastic package or 1242 mA for the thermally enhanced package. The total set of enabled functions and operating conditions for a given application must support these current consumption limits.

Figure 59 and Figure 60 can be used to determine the suitability of a given AD9852 application in terms of the power dissipation requirements. These graphs assume that the AD9852 device is soldered to a multilayer PCB according to the recommended best manufacturing practices and procedures for a given package type. This ensures that the specified thermal impedance specifications are achieved.

### THERMALLY ENHANCED PACKAGE MOUNTING GUIDELINES

Refer to the [AN-772 Application Note](#) for details on mounting devices with an exposed paddle.



## EVALUATION BOARD

An evaluation board is available that supports the AD9852 DDS device. This evaluation board consists of a PCB, software, and documentation to facilitate bench analysis of the performance of the AD9852 device. It is recommended that users of the AD9852 familiarize themselves with the operation and performance capabilities of the device by using the evaluation board. The evaluation board should also be used as a PCB reference design to ensure optimum dynamic performance from the device.

### EVALUATION BOARD INSTRUCTIONS

The AD9852/AD9854 Rev. E evaluation board includes either an AD9852ASVZ or AD9854ASVZ IC.

The ASVZ package permits 300 MHz operation by virtue of its thermally enhanced design. This package has a bottom-side heat slug that must be soldered to the ground plane of the PCB directly beneath the IC. In this manner, the evaluation board PCB ground plane layer extracts heat from the AD9852 or AD9854 IC package. If device operation is limited to 200 MHz or less, the ASTZ package can be used without a heat slug in customer installations over the full temperature range.

Evaluation boards for both the AD9852 and AD9854 are identical except for the installed IC.

To assist in proper placement of the pin header shorting jumpers, the instructions refer to direction (left, right, top, bottom) as well as header pins to be shorted. Pin 1 for each 3-pin header is marked on the PCB corresponding with the schematic diagram. When following these instructions, position the PCB so that the PCB text can be read from left to right. The board is shipped with the pin headers configuring the board as follows:

- REFCLK for the AD9852 or AD9854 is configured as differential. The differential clock signals are provided by the MC100LVEL16D differential receiver.
- Input clock for the MC100LVEL16D is single ended via J25. This signal may be 3.3 V CMOS or a 2 V p-p sine wave capable of driving 50  $\Omega$  (R13).
- Both DAC outputs from the AD9852 or AD9854 are routed through the two 120 MHz elliptical LP filters, and their outputs are connected to J7 (Q, or control DAC) and J6 (I, or cosine DAC).
- The board is set up for software control via the printer port connector.
- The output currents of the DAC are configured for 10 mA.

### GENERAL OPERATING INSTRUCTIONS

Load the CD software onto the PC's hard disk. Connect a printer cable from the PC to the AD9852 evaluation board printer port connector labeled J11. The current software (Version 1.72) supports Windows® 95 or better operating systems.

#### Hardware Preparation

Using the schematic in conjunction with these instructions helps acquaint the user with the electrical functioning of the evaluation board.

Attach power wires to the connector labeled TB1 using the screw-down terminals. This is a plastic connector that press-fits over a 4-pin header soldered to the board. Table 14 lists the connections to each pin.

**Table 14. Power Requirements for DUT Pins<sup>1</sup>**

AVDD 3.3 V	DVDD 3.3 V	VCC 3.3 V	Ground
All DUT analog pins	All DUT digital pins	All other devices	All devices

<sup>1</sup> DUT = device under test.

#### Clock Input, J25

Attach REFCLK to the clock input, J25. This is a single-ended input that is routed to the MC100LVEL16D for conversion to differential PECL output. This is accomplished by attaching a 2 V p-p clock or sine wave source to J25. This is a 50  $\Omega$  impedance point set by R13. The input signal is ac-coupled and then biased to the center-switching threshold of the MC100LVEL16D. To engage the differential clocking mode of the AD9852, Pin 2 and Pin 3 (the bottom two pins) of W3 must be connected with a shorting jumper.

The signal arriving at the AD9852 is called the reference clock. If the user chooses to engage the on-chip PLL clock multiplier, this signal is the reference clock for the PLL and the multiplied PLL output becomes the system clock. If the user chooses to bypass the PLL clock multiplier, the reference clock that has been supplied is directly operating the AD9852 and is therefore the system clock.

#### Three-State Control

Three of the following control or switch headers must be shorted to allow the provided software to control the evaluation board via Printer Port Connector J11: W9, W11, W12, W13, W14, and W15.

## Programming

If a PC and Analog Devices software are not used to program the AD9852, the W9, W11, W12, W13, W14, and W15 headers should be opened (shorting jumpers removed). This effectively detaches the PC interface and allows J10 (the 40-pin header) and J1 to assume control without bus contention. Input signals on J10 and J1 going to the AD9852 should be 3.3 V CMOS logic levels.

## Low-Pass Filter Testing

The purpose of the 2-pin W7 and W10 headers (associated with J4 and J5) is to allow the two 50  $\Omega$ , 120 MHz filters to be tested during PCB assembly without interference from other circuitry attached to the filter inputs. Normally, a shorting jumper is attached to each header to allow the DAC signals to be routed to the filters. If the user wishes to test the filters, the shorting jumpers at W7 and W10 should be removed and 50  $\Omega$  test signals should be applied at the J4 and J5 inputs to the 50  $\Omega$  elliptic filters. The user can refer to the provided schematic (Figure 61 and Figure 62) and the following sections to properly position the remaining shorting jumpers.

### Observing the Unfiltered IOUT1 and the Unfiltered IOUT2 DAC Signals

The unfiltered DAC outputs can be observed at J5 (the I, or cosine DAC, signal) and J4 (the Q, or control DAC, signal). Use the following procedure to route the two 50  $\Omega$  terminated analog DAC outputs to the SMB connectors and to disconnect any other circuitry.

1. Install shorting jumpers at W7 and W10.
2. Remove the shorting jumper at W16.
3. Remove the shorting jumper from the 3-pin W1 header.
4. Install a shorting jumper on Pin 1 and Pin 2 (bottom two pins) of the 3-pin W4 header.

The raw DAC outputs may appear as a series of quantized (stepped) output levels that do not resemble a sine wave until they are filtered. The default 10 mA output current develops a 0.5 V p-p signal across the on-board 50  $\Omega$  termination. If the observation equipment uses 50  $\Omega$  inputs, the DAC develops only 0.25 V p-p due to the double termination.

If using the AD9852 evaluation board, the user can control IOUT2 (the control DAC output) by using the serial or parallel ports. The 12-bit, two's complement value(s) is/are written to the control DAC register that sets the IOUT2 output to a static dc level. Allowable hexadecimal values are 7FF (maximum) to 800 (minimum), with all 0s being midscale. Rapidly changing the contents of the control DAC register (up to 100 MSPS) allows IOUT2 to assume any programmable waveform.

### Observing the Filtered IOUT1 and the Filtered IOUT2

The filtered I (cosine DAC) and Q (control DAC) outputs can be observed at J6 (the I, or cosine DAC, signal) and J7 (the Q, or control DAC, signal). Use the following procedure to route the 50  $\Omega$  (input and output Z) low-pass filters into the pathways of

the I and Q signals to remove images, aliased harmonics, and other spurious signals that are greater than approximately 120 MHz:

1. Install shorting jumpers at W7 and W10.
2. Install a shorting jumper at W16.
3. Install a shorting jumper on Pin 1 and Pin 2 (bottom two pins) of the 3-pin W1 header.
4. Install a shorting jumper on Pin 1 and Pin 2 (bottom two pins) of the 3-pin W4 header.
5. Install a shorting jumper on Pin 2 and Pin 3 (bottom two pins) of the 3-pin W2 and W8 headers.

The resulting signals appear as nearly pure sine waves and are 90° out of phase with each other. These filters are designed with the assumption that the system clock speed is at or near its maximum speed (300 MHz). If the system clock speed is much less than 300 MHz, for example 200 MHz, it is possible, or inevitable, that unwanted DAC products other than the fundamental signal will be passed by the low-pass filters.

If an AD9852 evaluation board is used, any reference to the Q signal should be interpreted to mean the control DAC.

### Observing the Filtered IOUT1 and the Filtered IOUT2

The filtered I DAC outputs can be observed at J6 (the true signal) and J7 (the complementary signal). Use the following procedure to route the 120 MHz low-pass filters in the true and complementary output paths of the I DAC to remove images, aliased harmonics, and other spurious signals above approximately 120 MHz:

1. Install shorting jumpers at W7 and W10.
2. Install a shorting jumper at W16.
3. Install a shorting jumper on Pin 2 and Pin 3 (top two pins) of the 3-pin W1 header.
4. Install a shorting jumper on Pin 2 and Pin 3 (top two pins) of the 3-pin W4 header.
5. Install a shorting jumper on Pin 2 and Pin 3 (bottom two pins) of the 3-pin W2 and W8 headers.

The resulting signals appear as nearly pure sine waves and are 180° out of phase with each other. If the system clock speed is much less than 300 MHz, for example 200 MHz, it is possible, or inevitable, that unwanted DAC products other than the fundamental signal will be passed by the low-pass filters.

### Connecting the High Speed Comparator

To connect the high speed comparator to the DAC output signals use either the quadrature filtered output configuration (AD9854 only) or the complementary filtered output configuration (both AD9854 and AD9852). Follow Step 1 through Step 4 of either the Observing the Filtered IOUT1 and the Filtered IOUT2 section or the Observing the Filtered IOUT1 and the Filtered IOUT2 section. Then install a shorting jumper on Pin 1 and Pin 2 (the top two pins) of the 3-pin W2 and W8 headers.

This step reroutes the filtered signals from the output connectors (J6 and J7) to the 100  $\Omega$  configured comparator inputs. This sets up the comparator for differential input without affecting the comparator output duty cycle, which should be approximately 50% for the complementary filtered output configuration.

The user can change the value of  $R_{SET}$  Resistor R2 from 3.9 k $\Omega$  to 1.95 k $\Omega$  to receive more robust signals at the comparator inputs. This decreases jitter and extends the operating range of the comparator. To implement this change install a shorting jumper at W6, which provides a second 3.9 k $\Omega$  chip resistor (R20) in parallel with that provided by R2. This boosts the DAC output current from 10 mA to 20 mA and doubles the peak-to-peak output voltage developed across the loads, thus resulting in more robust signals at the comparator inputs.

### Single-Ended Configuration

To connect the high speed comparator in a single-ended configuration so that the duty cycle or pulse width can be controlled, a dc threshold voltage must be present at one of the comparator inputs. This voltage can be supplied using the control DAC. A 12-bit, twos complement value is written to the control DAC register that sets the IOUT2 output to a static dc level. Allowable hexadecimal values are 7FF (maximum) to 800 (minimum), with all 0s being midscale. The IOUT1 channel continues to output a user-programmable, filtered sine wave. These two signals are routed to the comparator by using the 3-pin W2 and W8 header switches. Use of the configuration described in the Observing the Filtered IOUT1 and the Filtered IOUT2 section is required. Follow Step 1 through Step 4 in this section, and then install a shorting jumper on Pin 1 and Pin 2 (top two pins) of the 3-pin W2 and W8 header switches.

The user can change the value of  $R_{SET}$  Resistor R2 from 3.9 k $\Omega$  to 1.95 k $\Omega$  to receive more robust signals at the comparator inputs. This decreases jitter and extends the operating range of the comparator. To implement this change install a shorting jumper at W6, which provides a second 3.9 k $\Omega$  chip resistor (R20) in parallel with that provided by R2.

### USING THE PROVIDED SOFTWARE

The evaluation software is provided on a CD, along with a brief set of instructions. Use the instructions in conjunction with the AD9852 or [AD9854](#) data sheet and the AD9852 or [AD9854](#) evaluation board schematic.

The CD-ROM contains the following:

- The AD9852/AD9854 evaluation software
- AD9852 evaluation board instructions
- AD9852 data sheet
- AD9852 evaluation board schematics
- AD9852 PCB layout

Several numerical entries, such as frequency and phase information, require pressing **ENTER** to register this information. For example, if a new frequency is input but does not take effect when **Load** is clicked, the user probably neglected to press **ENTER** after inputting the new frequency information.

Typical operation of the AD9852/AD9854 evaluation board begins with a master reset. After this reset, many of the default register values are depicted in the software control panel. The reset command sets the DDS output amplitude to minimum and 0 Hz, zero phase offset, as well as other states that are listed in the Register Layout table (Table 9).

The next programming block should be the reference clock and multiplier because this information is used to determine the proper 48-bit frequency tuning words that are entered and later calculated.

The output amplitude defaults to the 12-bit, straight binary multiplier values of the I (cosine DAC) multiplier register of 000 hex; no output (dc) should be seen from the DAC. Set the multiplier amplitude in the **Output Amplitude** dialog box to a substantial value, such as FFF hex. The digital multiplier can be bypassed by selecting the **Output Amplitude is always Full Scale** box, but this usually does not result in the best spurious-free dynamic range (SFDR). The best SFDR, achieving improvements of up to 11 dB, is obtained by routing the signal through the digital multiplier and reducing the multiplier amplitude. For instance, FC0 hex produces less spurious signal amplitude than FFF hex. If SFDR must be maximized, this exploitable and repeatable phenomenon should be investigated in the given application. This phenomenon is more readily observed at higher output frequencies, where good SFDR becomes more difficult to achieve.

Refer to this data sheet and the evaluation board schematic (Figure 61 and Figure 62) for information about the available functions of the AD9852 and how the software responds to programming commands.

### SUPPORT

Applications assistance is available for the AD9852, the AD9852 evaluation board, and all other products of Analog Devices. Call 1-800-ANALOGD or visit [www.analog.com/dds](http://www.analog.com/dds).

# AD9852

Table 15. AD9852 Customer Evaluation Board (AD9852 PCB > U1 = AD9852ASVZ)

Item	Qty	Reference Designator	Device	Package	Value	Min Tol	Manufacturer	Manufacturer Part No.
1	3	C1, C2, C45	Capacitor 0805	805	0.01 $\mu$ F, 50 V, X7R	10%	Kemet Corp.	C0805C103K5RACTU
2	21	C7, C8, C9, C10, C11, C12, C13, C14, C16, C17, C18, C19, C20, C22, C23, C24, C26, C27, C28, C29, C44	Capacitor 0603	603	0.1 $\mu$ F, 50 V, X7R	10%	Murata Manufacturing Co., Ltd.	GRM188R71H104KA93D
3	2	C4, C37	Capacitor 1206	1206	27 pF, 50 V, NPO	5%	Yageo Corporation	CC1206JRNPO9BN270
4	2	C5, C38	Capacitor 1206	1206	47 pF, 50 V, NPO	5%	Yageo Corporation	CC1206JRNPO9BN470
5	3	C6, C21, C25	Capacitor TAJC	TAJC	10 $\mu$ F, 16 V, TAJ	10%	AVX	TAJC106K016R
6	2	C30, C39	Capacitor 1206	1206	39 pF, 50 V, NPO	5%	Yageo Corporation	CC1206JRNPO9BN390
7	2	C31, C40	Capacitor 1206	1206	22 pF, 50 V, NPO	5%	Yageo Corporation	CC1206JRNPO9BN220
8	2	C32, C41	Capacitor 1206	1206	2.2 pF, 50 V, NPO	0.25 pF	Yageo Corporation	CC1206CRNPO9BN2R2
9	2	C33, C42	Capacitor 1206	1206	12 pF, 50 V, NPO	5%	Yageo Corporation	1206CG120J9B200
10	2	C34, C43	Capacitor 1206	1206	8.2 pF, 50 V, NPO	0.5 pF	Yageo Corporation	CC1206DRNPO9BN8R2
11	9	J1, J2, J3, J4, J5, J6, J7, J25, J26	SMB	STR-PC MNT	N/A	N/A	Emerson/Johnson	131-3701-261
12	1	J10	40-pin header	Header 40	N/A	N/A	Samtec, Inc.	TSW-120-23-L-D
13	4	L1, L2, L3, L5	Inductor coil	1008CS	68 nH	2%	Coilcraft, Inc.	1008CS-680XGLB
14	2	L4, L6	Inductor coil	1008CS	82 nH	2%	Coilcraft, Inc.	1008CS-820XGLB
15	2	R1, R5	RES_SM	1206	49.9 $\Omega$ , 1/4 W	1%	Panasonic-ECG	ERJ-8ENF49R9V
16	2	R2, R20	RES_SM	1206	3.92 k $\Omega$ , 1/4 W	1%	Panasonic-ECG	ERJ-8ENF3921V
17	2	R3, R7	RES_SM	1206	24.9 $\Omega$ , 1/4 W	1%	Panasonic-ECG	ERJ-8ENF24R9
18	1	R4	RES_SM	1206	1.3 k $\Omega$ , 1/4 W	1%	Panasonic-ECG	ERJ-8ENF1301V
19	4	R6, R11, R12, R13	RES_SM	1206	49.9 $\Omega$ , 1/4 W	1%	Panasonic-ECG	ERJ-8ENF49R9V
20	1	R8	RES_SM	1206	2 k $\Omega$ , 1/4 W	1%	Panasonic-ECG	ERJ-8ENF2001V
21	2	R9, R10	RES_SM	1206	100 $\Omega$ , 1/4 W	1%	Panasonic-ECG	ERJ-8ENF1000V
22	4	R15, R16, R17, R18	RES_SM	1206	10 k $\Omega$ , 1/4 W	1%	Panasonic-ECG	ERJ-8ENF1002V
23	1	RP1	Resistor network	SIP-10P	10 k $\Omega$	2%	Bourns	4610X-101-103LF

Item	Qty	Reference Designator	Device	Package	Value	Min Tol	Manufacturer	Manufacturer Part No.
24	1	TB1	TB4	4-position terminal	N/A	N/A	Wieland Electric, Inc.	Plug: 25.602.2453.0; terminal strip: Z5.530.3425.0
25	1	U1	AD9852	SV-80	N/A	N/A	Analog Devices, Inc.	AD9852ASVZ
26	1	U2	74HC125D	14 SOIC	N/A	N/A	Texas Instruments Incorporated	SN74HC125DR
27	1	U3	Primary: MC10EP16DGOS	8 SOIC	N/A	N/A	ON Semiconductor	Primary: MC10EP16DGOS
			Secondary: MC100LVEL16DGOS	8 SOIC	N/A	N/A	ON Semiconductor	Secondary: MC100LVEL16DGOS
28	4	U4, U5, U6, U7	74HC14	14 SOIC	N/A	N/A	Texas Instruments Incorporated	SN74HC14DR
29	3	U8, U9, U10	74HC574	20 SOIC	N/A	N/A	Texas Instruments Incorporated	SN74HC574DWR
30	1	J11	C36CRPX	36CRP	N/A	N/A	Tyco Electronics Corporation	5552742-1
31	6	W1, W2, W3, W4, W8, W17	3-pin header	SIP-3P	N/A	N/A	Samtec, Inc.	TSW-103-07-S-S
32	10	W6, W7, W9, W10, W11, W12, W13, W14, W15, W16	2-pin header	SIP-2P	N/A	N/A	Samtec, Inc.	TSW-102-07-S-S
33	6	W1, W2, W3, W4, W8, W17	Jumpers	N/A	Black	N/A	Samtec, Inc.	SNT-100-BK-G
34	10	W6, W7, W9, W10, W11, W12, W13, W14, W15, W16	Jumpers	N/A	Black	N/A	Samtec, Inc.	SNT-100-BK-G
35	2	N/A	Self-tapping screw	4-40, Phillips pan head	N/A	N/A		90410A107
36	4	N/A	Adhesive feet	N/A	Black	N/A	3M	SJ-5518
37	1	AD9852/54 PCB	N/A	N/A	N/A	N/A		GS02669 REV. E
38	2	R14, R19	RES_SM	1206	0 $\Omega$ , 1/4 W	5%	Panasonic-ECG	ERJ-8GEY0R00V
39	4	N/A	Pin socket (open end)				Tyco Electronics Corporation	5-5330808-6
40	1	Y1	XTAL	COSC	N/A	N/A	Optional	Optional

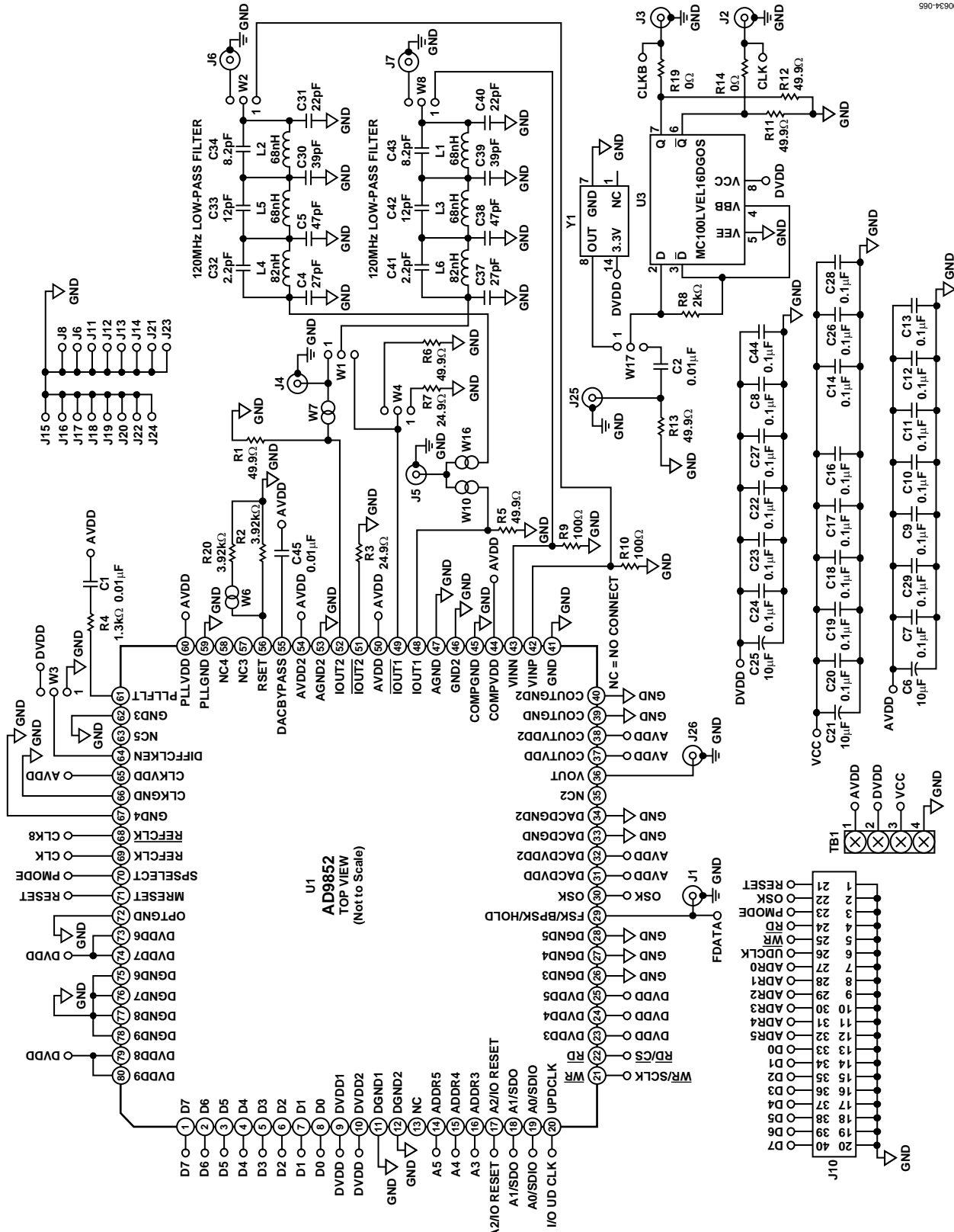

Figure 61. Evaluation Board Schematic

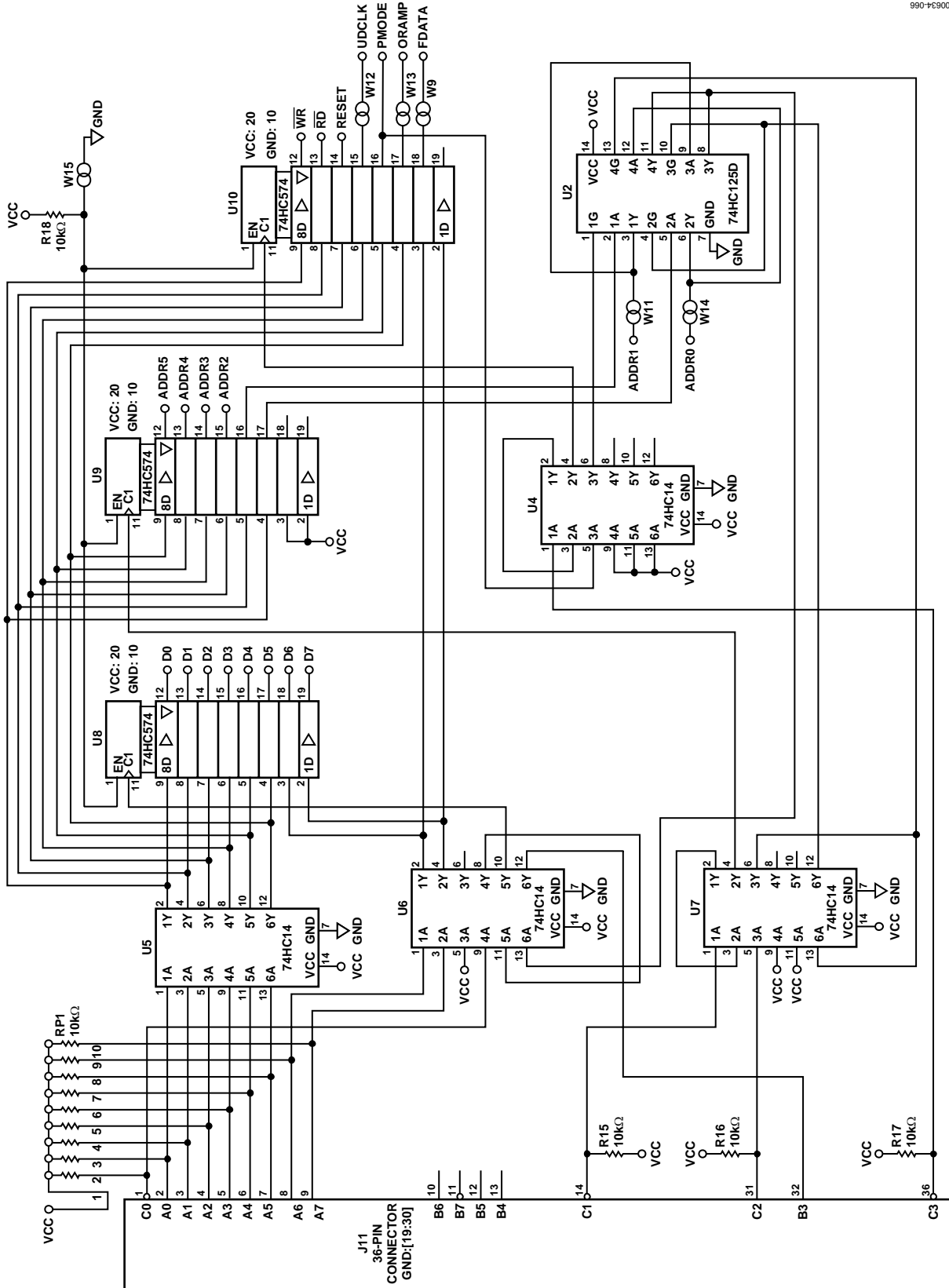

Figure 62. Evaluation Board Schematic



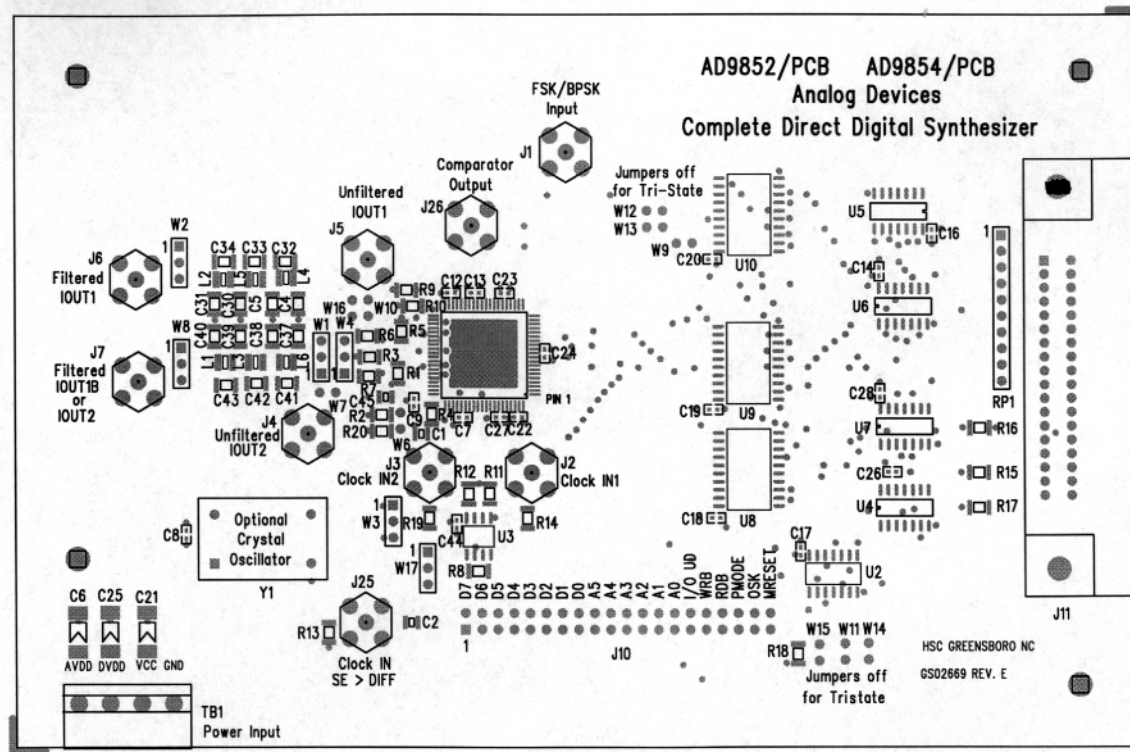

Figure 63. Assembly Drawing

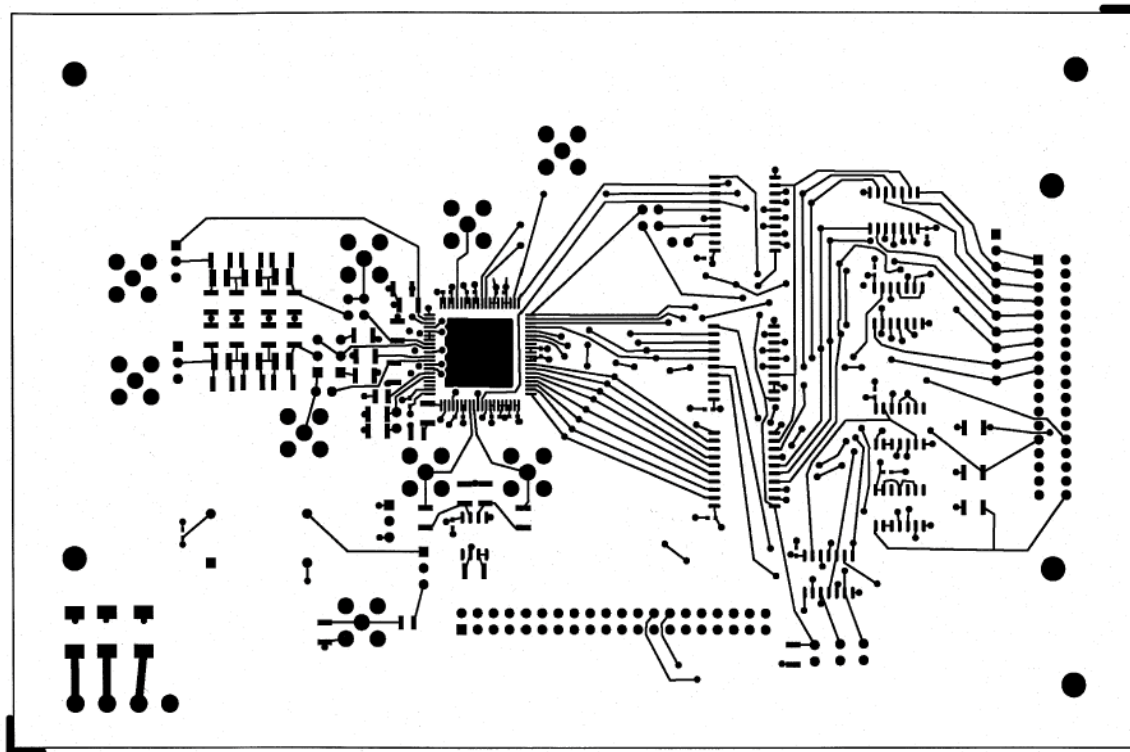
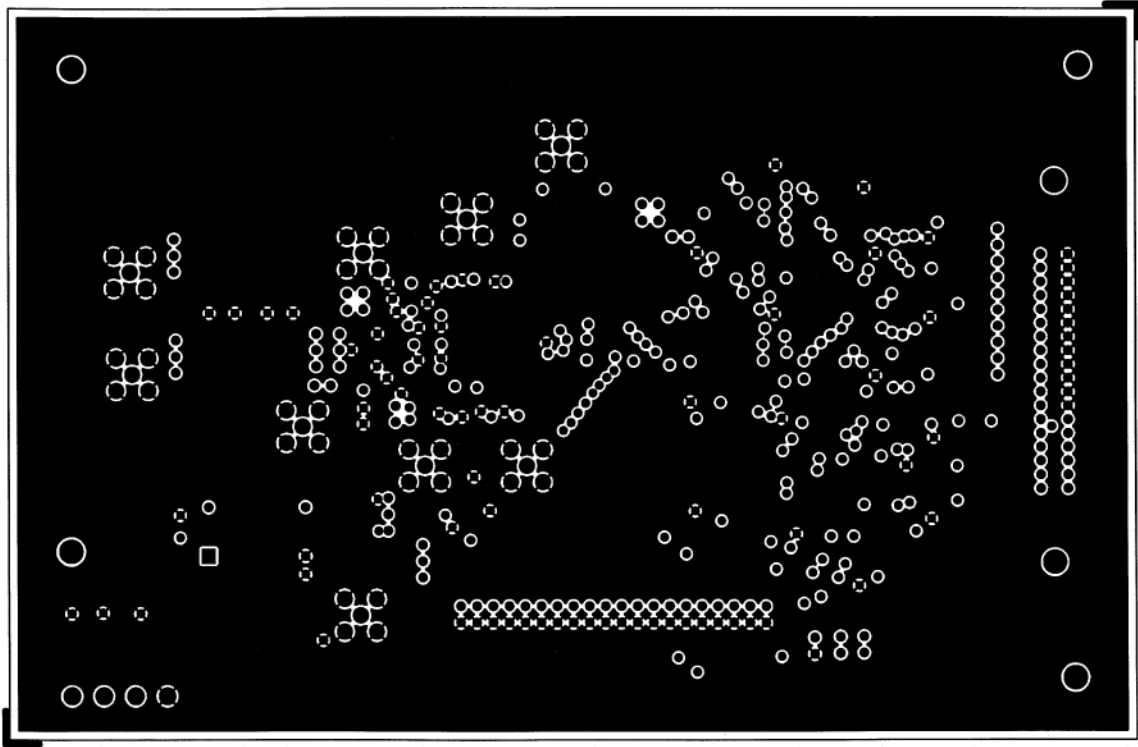

Figure 64. Top Routing Layer, Layer 1





00834-070

Figure 65. Ground Plane Layer, Layer 2

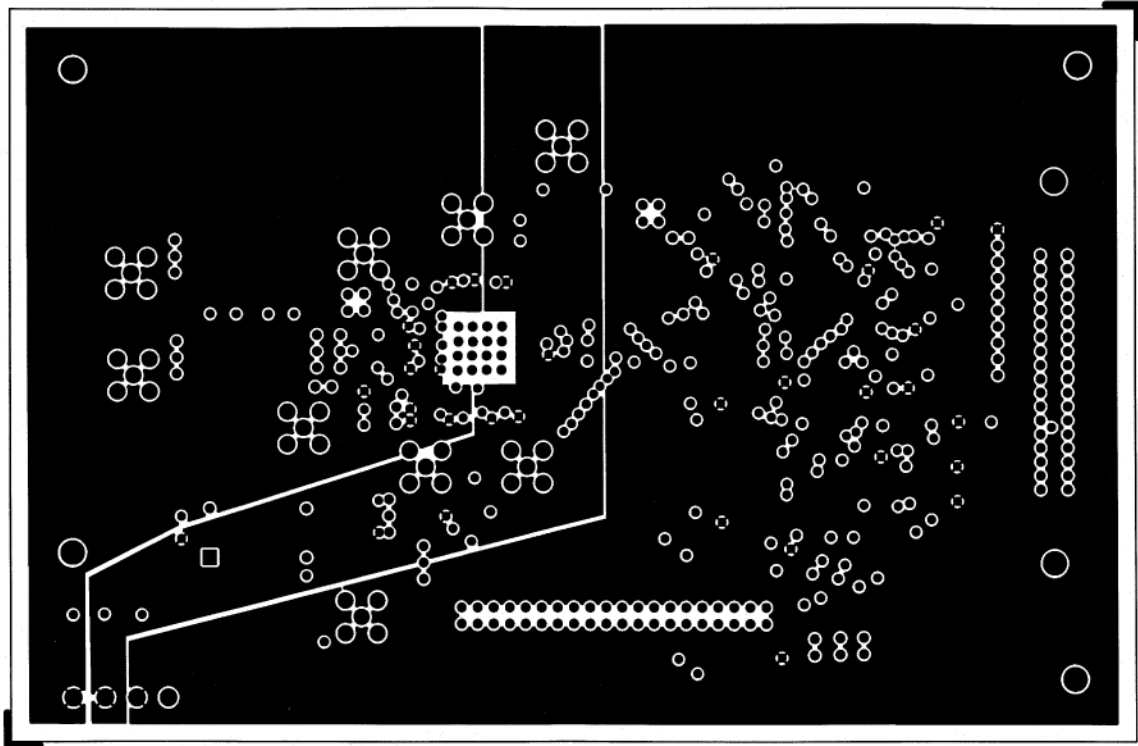

00834-069

Figure 66. Power Plane Layer, Layer 3

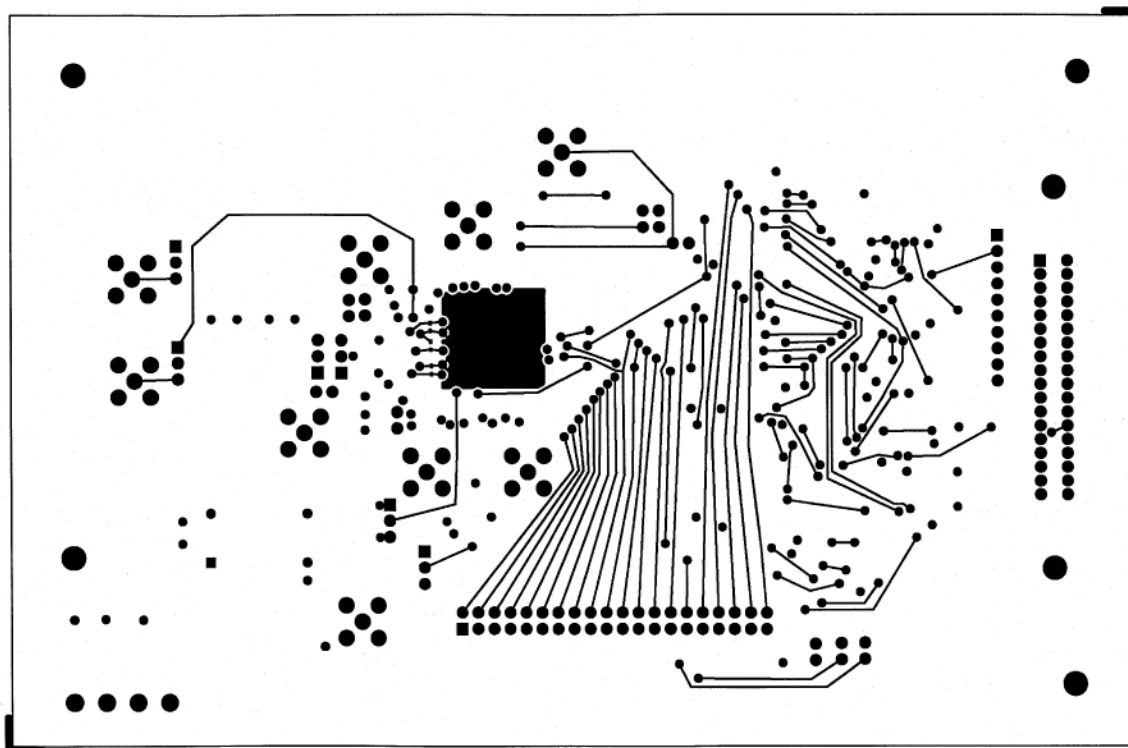

00834-071

Figure 67. Bottom Routing Layer, Layer 4

OUTLINE DIMENSIONS

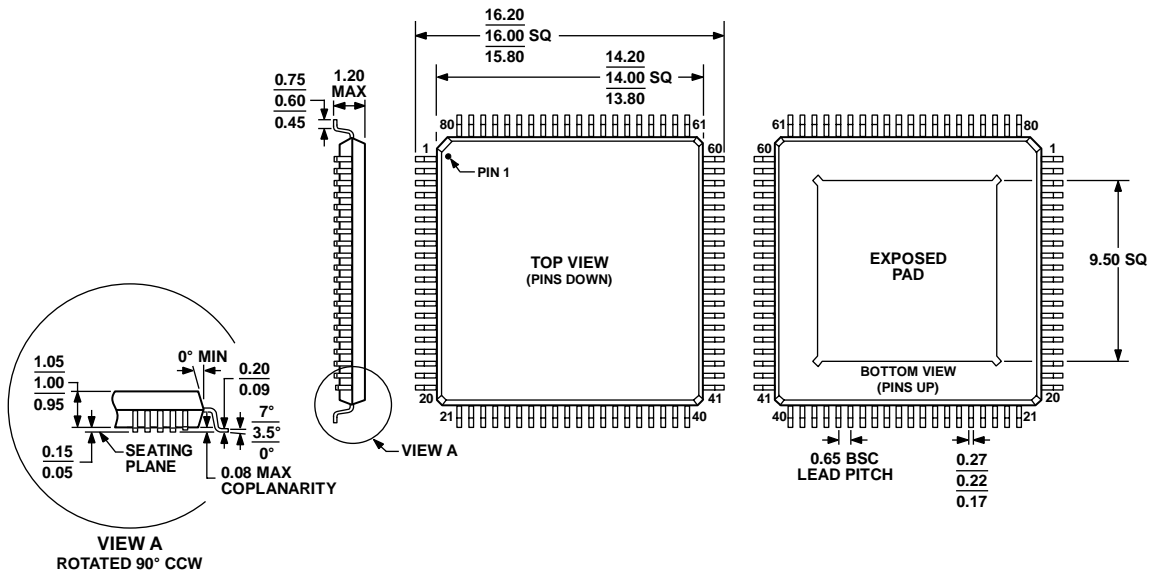

COMPLIANT TO JEDEC STANDARDS MS-026-AEC-HD  
 Figure 68. 80-Lead Thin Quad Flat Package, Exposed Pad [TQFP\_EP]  
 (SV-80-4)  
 Dimensions shown in millimeters

091506-A

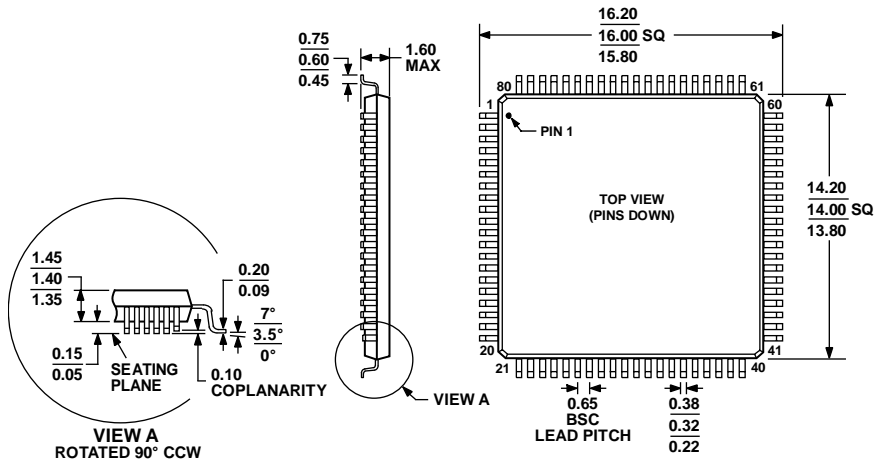

COMPLIANT TO JEDEC STANDARDS MS-026-BEC  
 Figure 69. 80-Lead Low Profile Quad Flat Package [LQFP]  
 (ST-80-2)  
 Dimensions shown in millimeters

051706-A

# AD9852

## ORDERING GUIDE

Model	Temperature Range	Package Description	Package Option
AD9852ASVZ <sup>1</sup>	–40°C to +85°C	80-Lead Thin Quad Flat Package, Exposed Pad [TQFP_EP]	SV-80-4
AD9852AST	–40°C to +85°C	80-Lead Low Profile Quad Flat Package [LQFP]	ST-80-2
AD9852ASTZ <sup>1</sup>	–40°C to +85°C	80-Lead Low Profile Quad Flat Package [LQFP]	ST-80-2
AD9852/PCB		Evaluation Board	

<sup>1</sup> Z = RoHS Compliant Part.