

Overview

KEMET's VP series of low and medium voltage plastic-encapsulated varistors are designed to protect electronic equipment against high voltage surges in the low and medium voltage region. They offer direct surface mount equivalents to leaded disc varistors of 5 and 7 mm sizes. The thermoplastic encapsulation is non-flammable according to the standard UL 94 V-0. Contacts are made of tinned copper sheet.

These transient voltage suppressors cover an operating voltage V_{rms} from 60 V to 300 V, featuring maximum surge currents from 400 – 1,200 A.

Benefits

- Surface mount form factor
- Operating ambient temperature of -40°C to +85°C
- Operating voltage range of 85 – 385 VDC
- Operating voltage (V_{rms}) of 60 – 300 V
- Available case sizes: 3225 and 4032
- Dimensional and weight savings on the board
- Non-flammable thermoplastic encapsulation according to the standard UL 94 V-0
- RoHS 2 2011/65/EC, REACH compliant

Applications

Typical applications include medical instruments, integrated circuits and transistors, mobile communication, white goods, entertainment electronics, lighting ballast, as well as protection of low and medium voltage boards, remote control and electrical counters and applications that are exposed to humidity.



Ordering Information

| VP | 3225 | K | 101 | R | 011 |
|---|----------------------------|------------|--|-----------------------|---|
| Series | Chip Size Code | Tolerances | Rated Peak Single Pulse Transient Current (A) | Packaging/Termination | Maximum Continuous Working Voltage (Vrms AC) |
| Varistor SMD 85°C Plastic Encapsulated | 3225 = 3225 4032 = 4032 | K = 10% | 401 = 400 122 = 1,200 (First two digits represent significant figures. Third digit specifies number of zeros.) | R = Reel 330 mm | 060 = 60 075 = 75 095 = 95 115 = 115 130 = 130 140 = 140 150 = 150 175 = 175 230 = 230 250 = 250 275 = 275 300 = 300 |

Dimensions – Millimeters

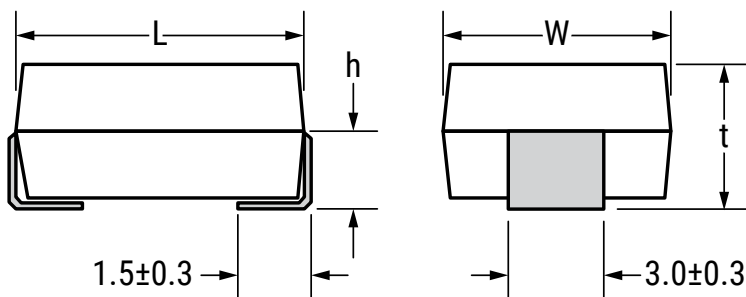

| Size Code | Voltage range V | L ±0.5 mm | W ±0.4 mm | h ±0.3 mm | t ±0.3 mm |
|-----------|-----------------|-----------|-----------|-----------|-----------|
| 3225 | 11 – 150 | 8.0 | 6.3 | 1.7 | 3.4 |
| 3225 | 175 – 300 | 8.0 | 6.3 | 2.3 | 4.7 |
| 4032 | 11 – 300 | 10.0 | 8.0 | 2.3 | 4.7 |

Environmental Compliance

RoHS 2 2011/65/EC, REACH

Performance Characteristics

| Continuous | Units | Value |
|--|-------|-------------|
| Steady State Applied Voltage | | |
| DC Voltage Range (V_{dc}) | V | 85 – 385 |
| AC Voltage Range (V_{rms}) | V | 60 – 300 |
| Transient | | |
| Non-Repetitive Surge Current, 8/20 μ s Waveform (I_{max}) | A | 400 – 1,200 |
| Non-Repetitive Surge Energy, 10/1,000 μ s Waveform (W_{max}) | J | 3 – 30 |
| Operating Ambient Temperature | °C | -40 to +85 |
| Storage Temperature Range (mounted components) | °C | -40 to +125 |
| Threshold Voltage Temperature Coefficient | %/°C | < +0.05 |
| Response Time | ns | < 5 |
| Climatic Category | | 40/85/56 |

Qualifications

| Reliability Parameter | Test | Tested According to | Condition to be Satisfied after Testing |
|--------------------------|----------------------------|---|--|
| AC/DC Bias Reliability | AC/DC Life Test | CECC 42200, Test 4.20 or IEC 1051-1, Test 4.20. AEC-Q200 Test 8 – 1,000 hours at UCT | $ \delta_{Vn} (1 \text{ mA}) < 10\%$ |
| Pulse Current Capability | I_{max} 8/20 μ s | CECC 42200, Test C 2.1 or IEC 1051-1, Test 4.5. 10 pulses in the same direction at 2 pulses per minute at maximum peak current for 10 pulses | $ \delta_{Vn} (1 \text{ mA}) < 10\%$ no visible damage |
| Pulse Energy Capability | W_{max} 10/1,000 μ s | CECC 42200, Test C 2.1 or IEC 1051-1, Test 4.5. 10 pulses in the same direction at 1 pulses every 2 minutes at maximum peak current for 10 pulses | $ \delta_{Vn} (1 \text{ mA}) < 10\%$ no visible damage |
| WLD Capability | WLD x 10 | ISO 7637, Test pulse 5, 10 pulses at rate 1 per minute | $ \delta_{Vn} (1 \text{ mA}) < 15\%$ no visible damage |
| V_{jump} Capability | V_{jump} 5 minutes | Increase of supply voltage to $V \geq V_{jump}$ for 1 minute | $ \delta_{Vn} (1 \text{ mA}) < 15\%$ no visible damage |

Qualifications cont'd

| Reliability Parameter | Test | Tested According to | Condition to be Satisfied after Testing |
|---------------------------------------|---|---|--|
| Environmental and Storage Reliability | Climatic Sequence | CECC 42200, Test 4.16 or IEC 1051-1, Test 4.17. a) Dry heat, 16 hours, UCT, Test Ba, IEC 68-2-2 b) Damp heat, cyclic, the first cycle: 55°C, 93% RH, 24 hours, Test Db 68-2-4 c) Cold, LCT, 2 hours Test Aa IEC 68-2-1 d) Damp heat cyclic, remaining 5 cycles: 55°C, 93% RH, 24 hour/cycle, Test Bd, IEC 68-2-30 | $ \delta_{vn} (1 \text{ mA}) < 10\%$ |
| | Thermal Shock | CECC 42200, Test 4.12, Test Na, IEC 68-2-14, AEC-Q200 Test 16, 5 cycles UCT/LCT, 30 minutes | $ \delta_{vn} (1 \text{ mA}) < 10\%$ no visible damage |
| | Steady State Damp Heat | CECC 42200, Test 4.17, Test Ca, IEC 68-2-3, AEC-Q200 Test 6, 56 days, 40°C, 93% RH. AEC-Q200 Test 7: Bias, RH, T all at 85. | $ \delta_{vn} (1 \text{ mA}) < 10\%$ |
| | Storage Test | IEC 68-2-2, Test Ba, AEC-Q200 Test 3, 1,000 hours at maximum storage temperature | $ \delta_{vn} (1 \text{ mA}) < 5\%$ |
| Mechanical Reliability | Solderability | CECC 42200, Test 4.10.1, Test Ta IEC 68-2-20 solder bath and reflow method | Solderable at shipment and after 1 year of storage, criteria > 95% must be covered by solder for reflow meniscus |
| | Resistance to Soldering Heat | CECC 42200, Test 4.10.2, Test Tb, IEC 68-2-20 solder bath and reflow method | $ \delta_{vn} (1 \text{ mA}) < 5\%$ |
| | Terminal Strength | JIS-C-6429, App. 1, 18 N for 60 seconds – same for AEC-Q200 Test 22 | no visual damage |
| | Board Flex | JIS-C-6429, App. 2, 2 mm minimum AEC-Q200 test 21 – Board flex: 2 mm flex minimum | $ \delta_{vn} (1 \text{ mA}) < 2\%$ no visible damage |
| | Vibration | CECC 42200, Test 4.15, Test Fc, IEC 68-2-6, AEC-Q200 Test 14. Frequency range 10 – 55 Hz (AEC: 10 – 2,000 Hz) Amplitude 0.75 m/s ² or 98 m/s ² (AEC: 5 G for 20 minutes) Total duration 6 hours (3 x 2 hours) (AEC: 12 cycles each of 3 directions) Waveshape – half sine | $ \delta_{vn} (1 \text{ mA}) < 10\%$ no visible damage |
| Mechanical Shock | CECC 42200, Test 4.14, Test Ea, IEC 68-2-27, AEC-Q200 Test 13. Acceleration = 490 m/s ² (AEC: MIL-STD-202-Method 213), Pulse duration = 11 ms, Waveshape – half sine; Number of shocks = 3 x 6 | $ \delta_{vn} (1 \text{ mA}) < 10\%$ no visible damage | |
| Electrical Transient Conduction | ISO-7637-1 Pulses | AEC-Q200 Test 30: Test pulses 1 to 3. Also other pulses – freestyle. | $ \delta_{vn} (1 \text{ mA}) < 10\%$ no visible damage |

Table 1 – Ratings & Part Number Reference

| KEMET Part Number | h ±0.3 (mm) | L ±0.5 (mm) | W ±0.4 (mm) | t ±0.3 (mm) | V _{rms} | VDC | V _n 1 mA | V _c | I _c | W _{max} 10/1,000 μs (J) | P _{max} (W) | I _{max} 8/20 μs (A) | C _{typ} at 1 kHz (pF) |
|-------------------|-------------|-------------|-------------|-------------|--------------------|-------------------|-----------------------|------------------|------------------|----------------------------------|----------------------|------------------------------|--------------------------------|
| VP3225K401R060 | 1.7 | 8.0 | 6.3 | 3.4 | 60 | 85 | 100 | 165 | 5 | 3.0 | 0.1 | 400 | 330 |
| VP4032K122R060 | 2.3 | 10.0 | 8.0 | 4.7 | 60 | 85 | 100 | 165 | 10 | 7.0 | 0.25 | 1,200 | 680 |
| VP3225K401R075 | 1.7 | 8.0 | 6.3 | 3.4 | 75 | 100 | 120 | 200 | 5 | 4.0 | 0.1 | 400 | 270 |
| VP4032K122R075 | 2.3 | 10.0 | 8.0 | 4.7 | 75 | 100 | 120 | 200 | 10 | 9.0 | 0.25 | 1,200 | 550 |
| VP3225K401R095 | 1.7 | 8.0 | 6.3 | 3.4 | 95 | 125 | 150 | 250 | 5 | 6.0 | 0.1 | 400 | 220 |
| VP4032K122R095 | 2.3 | 10.0 | 8.0 | 4.7 | 95 | 125 | 150 | 250 | 10 | 11.0 | 0.25 | 1,200 | 440 |
| VP3225K401R115 | 1.7 | 8.0 | 6.3 | 3.4 | 115 | 150 | 180 | 300 | 5 | 6.5 | 0.1 | 400 | 180 |
| VP4032K122R115 | 2.3 | 10.0 | 8.0 | 4.7 | 115 | 150 | 180 | 300 | 10 | 13.0 | 0.25 | 1,200 | 360 |
| VP3225K401R130 | 1.7 | 8.0 | 6.3 | 3.4 | 130 | 170 | 205 | 340 | 5 | 7.0 | 0.1 | 400 | 160 |
| VP4032K122R130 | 2.3 | 10.0 | 8.0 | 4.7 | 130 | 170 | 205 | 340 | 10 | 15.0 | 0.25 | 1,200 | 320 |
| VP3225K401R140 | 1.7 | 8.0 | 6.3 | 3.4 | 140 | 180 | 220 | 360 | 5 | 7.5 | 0.1 | 400 | 150 |
| VP4032K122R140 | 2.3 | 10.0 | 8.0 | 4.7 | 140 | 180 | 220 | 360 | 10 | 18.0 | 0.25 | 1,200 | 300 |
| VP3225K401R150 | 1.7 | 8.0 | 6.3 | 3.4 | 150 | 200 | 240 | 395 | 5 | 9.0 | 0.1 | 400 | 140 |
| VP4032K122R150 | 2.3 | 10.0 | 8.0 | 4.7 | 150 | 200 | 240 | 395 | 10 | 18.5 | 0.25 | 1,200 | 280 |
| VP3225K401R175 | 1.7 | 8.0 | 6.3 | 4.7 | 175 | 225 | 270 | 455 | 5 | 9.5 | 0.1 | 400 | 120 |
| VP4032K122R175 | 2.3 | 10.0 | 8.0 | 4.7 | 175 | 225 | 270 | 455 | 10 | 21.0 | 0.25 | 1,200 | 250 |
| VP3225K401R230 | 1.7 | 8.0 | 6.3 | 4.7 | 230 | 300 | 360 | 595 | 5 | 10.0 | 0.1 | 400 | 95 |
| VP4032K122R230 | 2.3 | 10.0 | 8.0 | 4.7 | 230 | 300 | 360 | 595 | 10 | 23.0 | 0.25 | 1,200 | 190 |
| VP3225K401R250 | 1.7 | 8.0 | 6.3 | 4.7 | 250 | 320 | 390 | 650 | 5 | 11.0 | 0.1 | 400 | 80 |
| VP4032K122R250 | 2.3 | 10.0 | 8.0 | 4.7 | 250 | 320 | 390 | 650 | 10 | 25.0 | 0.25 | 1,200 | 180 |
| VP3225K401R275 | 1.7 | 8.0 | 6.3 | 4.7 | 275 | 350 | 430 | 710 | 5 | 13.0 | 0.1 | 400 | 75 |
| VP4032K122R275 | 2.3 | 10.0 | 8.0 | 4.7 | 275 | 350 | 430 | 710 | 10 | 29.0 | 0.25 | 1,200 | 160 |
| VP3225K401R300 | 1.7 | 8.0 | 6.3 | 4.7 | 300 | 385 | 470 | 775 | 5 | 15.0 | 0.1 | 400 | 70 |
| VP4032K122R300 | 2.3 | 10.0 | 8.0 | 4.7 | 300 | 385 | 470 | 775 | 10 | 30.0 | 0.25 | 1,200 | 150 |
| KEMET Part Number | h ±0.3 mm | L ±0.5 mm | W ±0.4 mm | t ±0.3 mm | V _{rms} V | V _{dc} V | V _n 1 mA V | V _c V | I _c A | W _{max} 10/1,000 μs J | P max W | I _{max} 8/20 μs A | C _{typ} @ 1 kHz pF |

Soldering

Popular soldering techniques used for surface mounted components are Wave and Infrared Reflow processes. Both processes can be performed with Pb-containing or Pb-free solders. The termination option available for these soldering techniques is Barrier Type End Terminations.

| End Termination | Designation | Recommended and Suitable for | Component RoHS Compliant |
|------------------------------------|-------------|-------------------------------------|--------------------------|
| Ni Sn Barrier Type End Termination | Ni R1 | Pb-containing and Pb-free soldering | Yes |

Wave Soldering – this process is generally associated with discrete components mounted on the underside of printed circuit boards, or for large top-side components with bottom-side mounting tabs to be attached, such as the frames of transformers, relays, connectors, etc. SMD varistors to be wave soldered are first glued to the circuit board, usually with an epoxy adhesive. When all components on the PCB have been positioned and an appropriate time is allowed for adhesive curing, the completed assembly is then placed on a conveyor and run through a single, double wave process.

Infrared Reflow Soldering – these reflow processes are typically associated with top-side component placement. This technique utilizes a mixture of adhesive and solder compounds (and sometimes fluxes) that are blended into a paste. The paste is then screened onto PCB soldering pads specifically designed to accept a particular sized SMD component. The recommended solder paste wet layer thickness is 100 to 300 µm. Once the circuit board is fully populated with MD components, it is placed in a reflow environment, where the paste is heated to slightly above its eutectic temperature. When the solder paste reflows, the SMD components are attached to the solder pads.

Solder Fluxes – solder fluxes are generally applied to populated circuit boards to clean oxides forming during the heating process and to facilitate the flowing of the solder. Solder fluxes can be either a part of the solder paste compound or can be separate materials, usually fluids. Recommended fluxes are:

- Non-activated (R) fluxes, whenever possible
- Mildly activated (RMA) fluxes of class L3CN
- Class ORLO

Activated (RA), water soluble or strong acidic fluxes with a chlorine content > 0.2 wt. % are NOT RECOMMENDED. The use of such fluxes could create high leakage current paths along the body of the varistor components. When a flux is applied prior to wave soldering, it is important to completely dry any residual flux solvents prior to the soldering process.

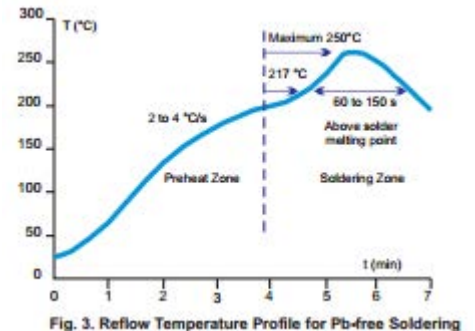
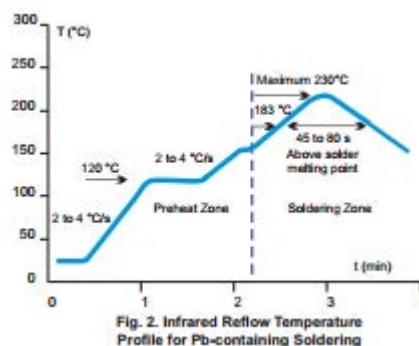
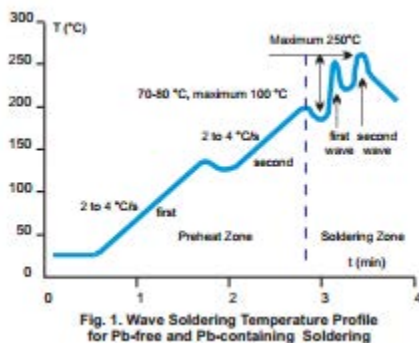

Thermal Shock – to avoid the possibility of generating stresses in the varistor chip due to thermal shock, a preheat stage to within 100°C of the peak soldering process temperature is recommended. Additionally, SMD varistors should not be subjected to a temperature gradient greater than 4°C/second, with an ideal gradient being 2°C/second. Peak temperatures should be controlled. Wave and Reflow soldering conditions for SMD varistors with Pb-containing solders are shown in Fig. 1 and 2 respectively, while Wave and Reflow soldering conditions for SMD varistors with Pb-free solders are shown in Figures 1 and 3

Soldering cont'd

Whenever several different types of SMD components are being soldered, each having a specific soldering profile, the soldering profile with the least heat and the minimum amount of heating time is recommended. Once soldering has been completed, it is necessary to minimize the possibility of thermal shock by allowing the hot PCB to cool to less than 50°C before cleaning.

Inspection Criteria – the inspection criteria to determine acceptable solder joints, when Wave or Infrared Reflow processes are used, will depend on several key variables, principally termination material process profiles.

Pb-containing Wave and IR Reflow Soldering – typical “before” and “after” soldering results for Barrier Type End Terminations can be seen in Fig. 4. Barrier type terminated varistors form a reliable electrical contact and metallurgical bond between the end terminations and the solder pads. The bond between these two metallic surfaces is exceptionally strong and has been tested by both vertical pull and lateral (horizontal) push tests. The results exceed established industry standards for adhesion.

The solder joint appearance of a barrier type terminated varistor shows that solder forms a metallurgical junction with the thin tin-alloy (over the barrier layer), and due to its small volume “climbs” the outer surface of the terminations, the meniscus will be slightly lower. This optical appearance should be taken into consideration when programming visual inspection of the PCB after soldering.

Ni Sn Barrier Type End Terminations

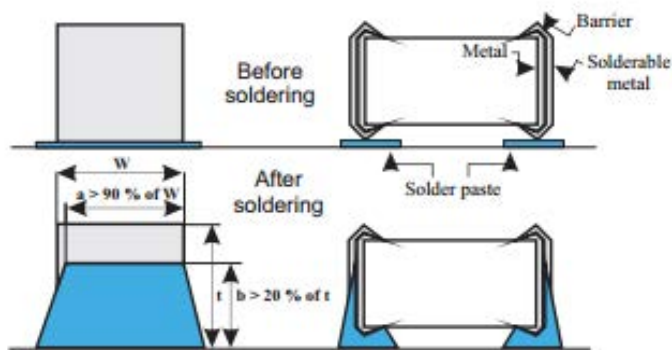

Figure 4: Soldering Criterion in case of Wave and IR Reflow Pb-containing Soldering

Pb-free Wave and IR Reflow Soldering – typical “before” and “after” soldering results for Barrier Type End Terminations are given in a phenomenon known as “mirror” or “negative” meniscus. Solder forms a metallurgical junction with the entire volume of the end termination, i.e. it diffuses from pad to end termination across the inner side, forming a “mirror” or “negative” meniscus. The height of the solder penetration can be clearly seen on the end termination and is always 30% higher than the chip height.

Soldering cont'd

Solder Test and Retained Samples – reflow soldering test based on J-STD-020D.1 and soldering test by dipping based on IEC 60068-2 for Pb-free solders are performed on each production lot as shown in the following chart. Test results and accompanying samples are retained for a minimum of two (2) years. The solderability of a specific lot can be checked at any time within this period should a customer require this information.

| Test | Resistance to Flux | Solderability | Static leaching (Simulation of Reflow Soldering) | Dynamic Leaching (Simulation of Wave Soldering) |
|------------------------------------|---|--|---|---|
| Parameter | | | | |
| Soldering method | Dipping | Dipping | Dipping | Dipping with agitation |
| Flux | L3CN, ORLO | L3CN, ORLO, R | L3CN, ORLO, R | L3CN, ORLO, R |
| Pb Solder | 62 Sn/36 Pb/2 Ag | | | |
| Pb Soldering temperature (°C) | 235±5 | 235±5 | 260±5 | 235±5 |
| Pb-FREE Solder | Sn96/Cu0,4-0,8/3-4Ag | | | |
| Pb-FREE Soldering Temperature (°C) | 250±5 | 250±5 | 280±5 | 250±5 |
| Soldering Time (s) | 2 | 210 | 10 | > 15 |
| Burn-in Conditions | VDC _{max} 48 h | | | |
| Acceptance Criterion | dVn < 5%, i _{dc} must stay unchanged | > 95% of end termination must be covered by solder | > 95% of end termination must be intact and covered by solder | > 95% of end termination must be intact and covered by solder |

Rework Criteria Soldering Iron – unless absolutely necessary, the use of soldering irons is NOT recommended for reworking varistor chips. If no other means of rework is available, the following criteria must be strictly followed:

- Do not allow the tip of the iron to directly contact the top of the chip
- Do not exceed the following soldering iron specifications:
 - Output Power: 30 Watts maximum
 - Temperature of Soldering Iron Tip: 280°C maximum
 - Soldering Time: 10 Seconds maximum

Storage Conditions – SMD varistors should be used within 1 year of shipment from factory to avoid possible soldering problems caused by oxidized terminals. The storage environment should be controlled, with humidity less than 40% and temperature between -25 and 45 °C. Varistor chips should always be stored in their original packaged unit.

Soldering Pad Configuration

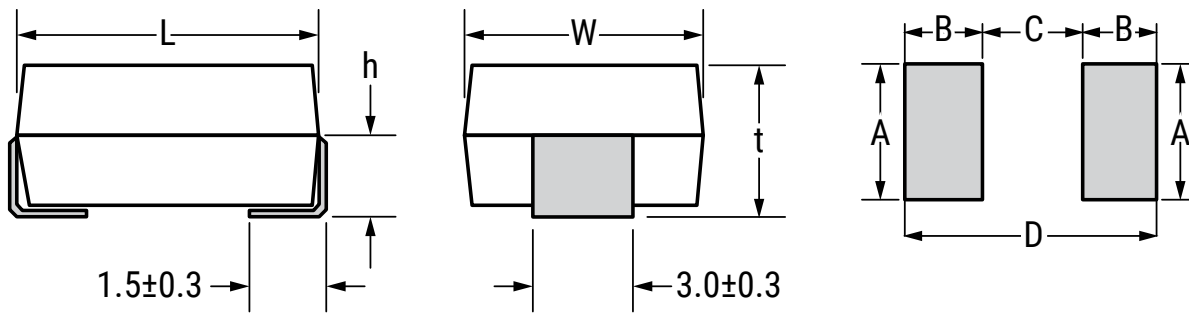

| Size | Voltage range V | L ±0.5 mm | W ±0.4 mm | h ±0.3 mm | t ±0.3 mm | A (mm) | B (mm) | C (mm) | D (mm) |
|------|-----------------|-----------|-----------|-----------|-----------|--------|--------|--------|--------|
| 3225 | 11 – 150 | 8.0 | 6.3 | 1.7 | 3.4 | 3.5 | 2.9 | 4.5 | 10.3 |
| 3225 | 175 – 300 | 8.0 | 6.3 | 2.3 | 4.7 | 3.5 | 2.9 | 4.5 | 10.3 |
| 4032 | 11 – 300 | 10.0 | 8.0 | 2.3 | 4.7 | 3.5 | 2.9 | 6.5 | 12.3 |

Packaging

| Voltage Range (V) | Chip Size | |
|-------------------|-----------|-------|
| | 3225 | 4032 |
| | Reel Size | |
| < 175 | 1,500 | 1,000 |
| > 175 | 1,000 | 1,000 |

Construction

Current Below 50 V

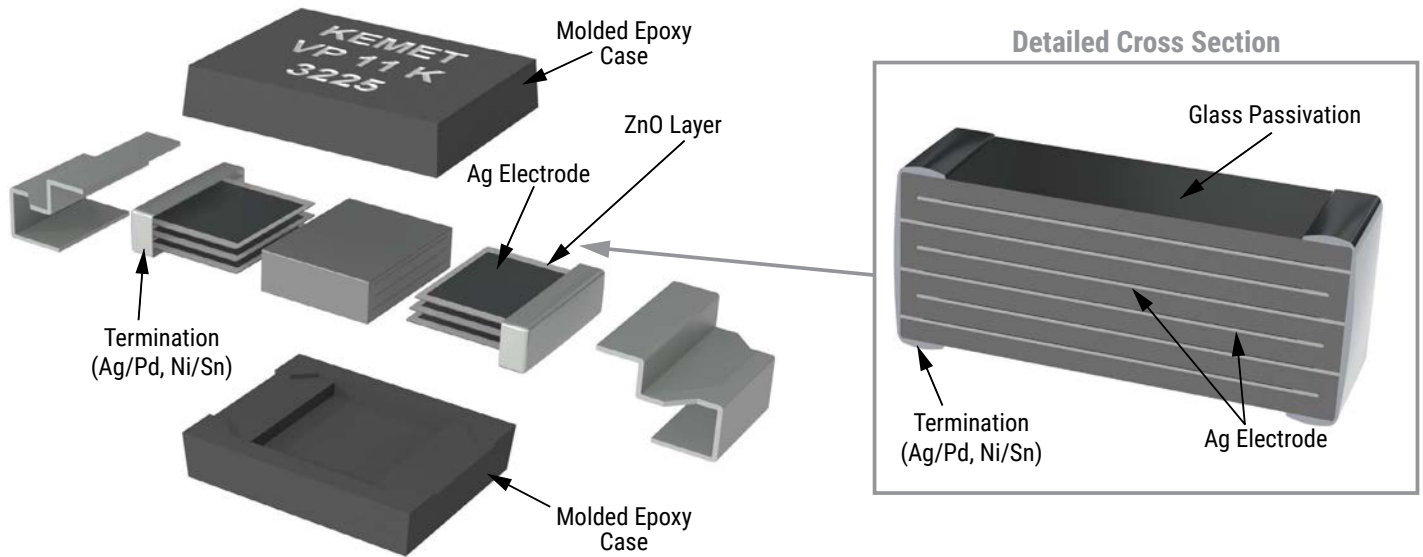

Current Equal or Greater than 50 V

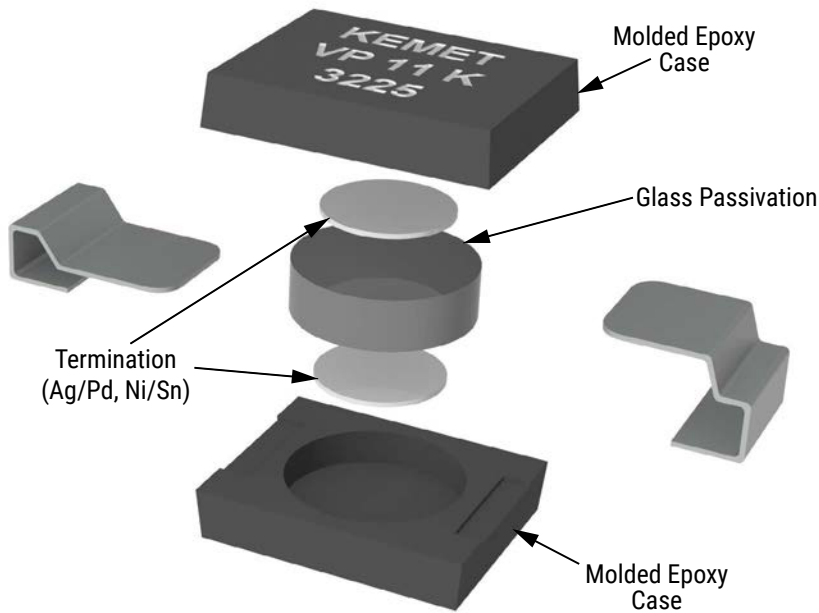

Marking

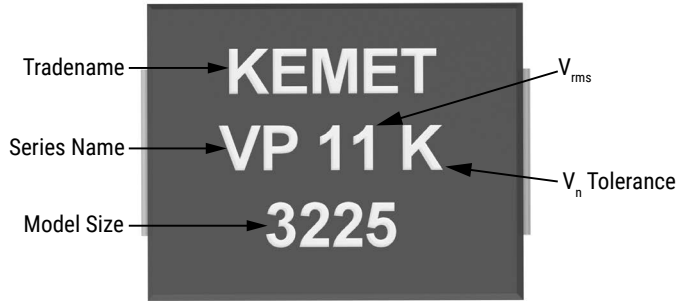

Taping & Reel Specifications



| Tape Size (mm) | 16 mm | |
|------------------------|------------|-------------|
| | 3225 | 4032 |
| A ₀ | 7.8 | 10.8 |
| B ₀ | 3.7 | 3.7 |
| K ₀ Maximum | 12.1 | 12.1 |
| B ₁ Maximum | 1.5 | 1.5 |
| D ₁ Minimum | 14.25 | 14.25 |
| E ₂ Minimum | 12.0 | 12.0 |
| P ₁ | 7.5 | 7.5 |
| F | 16.0 | 16.0 |
| W | 9.5 | 9.5 |
| T ₂ Maximum | 16.4+2 | 16.4+2 |
| W ₁ | 12.4+2 | 12.4+2 |
| W ₂ Maximum | 22.4 | 22.4 |
| W ₃ | 15.9 - 9.4 | 15.9 - 19.4 |
| A | 330 | 330 |

Terms and Definitions

| Term | Symbol | Definition |
|---|---------------|---|
| Rated AC Voltage | V_{rms} | Maximum continuous sinusoidal AC voltage (< 5% total harmonic distortion) which may be applied to the component under continuous operation conditions at 25°C |
| Rated DC Voltage | V_{dc} | Maximum continuous DC voltage (< 5% ripple) which may be applied to the component under continuous operating conditions at 25°C |
| Supply Voltage | V | The voltage by which the system is designated and to which certain operating characteristics of the system are referred; $V_{rms} = 1, 1 \times V$ |
| Leakage Current | I_{dc} | The current passing through the varistor at Vdc and at 25°C or at any other specified temperature |
| Varistor Voltage | V_n | Voltage across the varistor measured at a given reference current In |
| Reference Current | I_n | Reference current = 1 mA DC |
| Clamping Voltage Protection Level | V_c | The peak voltage developed across the varistor under standard atmospheric conditions, when passing an 8/20 μ s class current pulse |
| Class Current | I_c | A peak value of current which is 1/10 of the maximum peak current for 100 pulses at two per minute for the 8/20 μ s pulse |
| Voltage Clamping Ratio | V_c/V_{app} | A figure of merit measure of the varistor clamping effectiveness as defined by the symbols V_c/V_{app} , where ($V_{app} = V_{rms}$ or V_{dc}) |
| Jump Start Transient | V_{jump} | The jump start transient resulting from the temporary application of an overvoltage in excess of the rated battery voltage. The circuit power supply may be subjected to a temporary overvoltage condition due to the voltage regulation failing or it may be deliberately generated when it becomes necessary to boost start the car |
| Rated Single Pulse Transient Energy | W_{max} | Energy which may be dissipated for a single 10/1,000 μ s pulse of a maximum rated current, with rated AC voltage or rated DC voltage also applied, without causing device failure |
| Load Dump Transient | WLD | Load Dump is a transient which occurs in an automotive environment. It is an exponentially decaying positive voltage which occurs in the event of a battery disconnect while the alternator is still generating charging current with other loads remaining on the alternator circuit at the time of battery disconnect |
| Rated Peak Single Pulse Transient Current | I_{max} | Maximum peak current which may be applied for a single 8/20 μ s pulse, with, rated line voltage also applies, without causing device failure |
| Rated Transient Average Power Dissipation | P | Maximum average power which may be dissipated due to a group of pulses occurring within a specified isolated time period, without causing device failure at 25°C |
| Capacitance | C | Capacitance between two terminals of the varistor measured at 1 kHz |
| Response Time | tr | The time lag between application of a surge and varistor's "turn-on" conduction action |
| Varistor Voltage Temperature Coefficient | TC | $(V_n \text{ at } 85^\circ\text{C} - V_n \text{ at } 25^\circ\text{C}) / (V_n \text{ at } 25^\circ\text{C}) \times 60^\circ\text{C} \times 100$ |
| Insulation Resistance | IR | Minimum resistance between shorted terminals and varistor surface |
| Isolation Voltage | | The maximum peak voltage which may be applied under continuous operating conditions between the varistor terminations and any conducting mounting surface |
| Operating Temperature | | The range of ambient temperature for which the varistor is designed to operate continuously as defined by the temperature limits of its climatic category |
| Climatic Category | LCT/UCT/DHD | UCT = Upper Category Temperature – the maximum ambient temperature for which a varistor has been designed to operate continuously, LCT = Lower Category Temperature – the minimum ambient temperature at which a varistor has been designed to operate continuously DHD = Dump Heat Test Duration |
| Storage Temperature | | Storage temperature range without voltage applied |

KEMET Electronics Corporation Sales Offices

For a complete list of our global sales offices, please visit www.kemet.com/sales.

Disclaimer

All product specifications, statements, information and data (collectively, the "Information") in this datasheet are subject to change. The customer is responsible for checking and verifying the extent to which the Information contained in this publication is applicable to an order at the time the order is placed. All Information given herein is believed to be accurate and reliable, but it is presented without guarantee, warranty, or responsibility of any kind, expressed or implied.

Statements of suitability for certain applications are based on KEMET Electronics Corporation's ("KEMET") knowledge of typical operating conditions for such applications, but are not intended to constitute – and KEMET specifically disclaims – any warranty concerning suitability for a specific customer application or use. The Information is intended for use only by customers who have the requisite experience and capability to determine the correct products for their application. Any technical advice inferred from this Information or otherwise provided by KEMET with reference to the use of KEMET's products is given gratis, and KEMET assumes no obligation or liability for the advice given or results obtained.

Although KEMET designs and manufactures its products to the most stringent quality and safety standards, given the current state of the art, isolated component failures may still occur. Accordingly, customer applications which require a high degree of reliability or safety should employ suitable designs or other safeguards (such as installation of protective circuitry or redundancies) in order to ensure that the failure of an electrical component does not result in a risk of personal injury or property damage.

Although all product-related warnings, cautions and notes must be observed, the customer should not assume that all safety measures are indicated or that other measures may not be required.

KEMET is a registered trademark of KEMET Electronics Corporation.

Mouser Electronics

Authorized Distributor

Click to View Pricing, Inventory, Delivery & Lifecycle Information:

KEMET:

| | | | | | |
|---------------------------------------|---------------------------------------|---------------------------------------|---------------------------------------|---------------------------------------|---------------------------------------|
| <u>VP4032K122R150</u> | <u>VP4032K122R275</u> | <u>VP3225K401R150</u> | <u>VP4032K122R300</u> | <u>VP3225K401R275</u> | <u>VP3225K101R025</u> |
| <u>VP3225K401R115</u> | <u>VP4032K122R130</u> | <u>VP3225K401R140</u> | <u>VP4032K251R035</u> | <u>VP3225K401R050</u> | <u>VP4032K251R040</u> |
| <u>VP4032K122R175</u> | <u>VP4032K122R060</u> | <u>VP4032K122R095</u> | <u>VP4032K251R017</u> | <u>VP3225K101R040</u> | <u>VP3225K401R250</u> |
| <u>VP4032K251R020</u> | <u>VP3225K401R130</u> | <u>VP3225K401R060</u> | <u>VP4032K122R230</u> | <u>VP4032K122R250</u> | <u>VP4032K122R050</u> |
| <u>VP3225K401R075</u> | <u>VP3225K401R095</u> | <u>VP4032K122R140</u> | <u>VP3225K401R230</u> | <u>VP3225K401R300</u> | <u>VP3225K101R014</u> |
| <u>VP4032K251R030</u> | <u>VP4032K122R115</u> | <u>VP3225K401R175</u> | <u>VP4032K251R025</u> | <u>VP4032K251R014</u> | <u>VP3225K101R035</u> |
| <u>VP3225K101R017</u> | <u>VP3225K101R030</u> | <u>VP4032K251R011</u> | <u>VP4032K122R075</u> | <u>VP3225K101R011</u> | <u>VP3225K101R020</u> |