

TDTP4000W066C: 4kW Digital Bridgeless Totem-pole PFC Evaluation Board

Overview

This user guide describes the TDTP4000W066C 4kW bridgeless totem-pole power factor correction (PFC) evaluation board.

Very high efficiency single-phase AC-DC conversion is achieved with Transphorm's latest Gen IV (SUPERGaN™)

[TP65H035G4WS](#), a diode-free Gallium Nitride (GaN) FET bridge with low reverse-recovery charge. Using Transphorm GaN FETs in the fast-switching leg of the circuit and low-resistance MOSFETs in the slow-switching leg of the circuit results in improved performance and efficiency. For more information and complete design files, please visit [TDTP4000W066C-KIT](#),

The TDTP4000W066C-KIT is for evaluation purposes only.

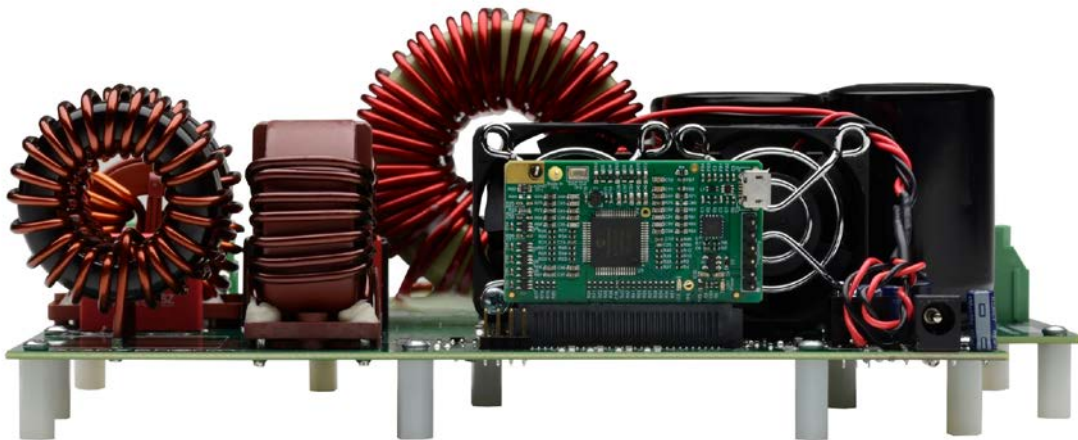

Figure 1. TDTP4000W066C-KIT 4kW totem-pole PFC evaluation board

Warning

This evaluation board is intended to validate Transphorm's SuperGaN FET technology and is for demonstration purposes only and no guarantees are made for standards compliance. There are areas of this evaluation board that have exposed access to hazardous high voltage levels. Exercise caution to avoid contact with those voltages. Also note that the evaluation board may retain high voltage temporarily after input power has been removed. Exercise caution when handling. When testing converters on an evaluation board, ensure adequate cooling is used. Apply cooling air with a fan blowing across the converter or across the heat sink attached to the converter. Monitor the converter temperature to ensure it does not exceed the maximum rated per the datasheet specification.

TDTP4000W066C User Guide

TDTP4000W066C input/output specifications

Input Voltage: 85 Vac to 270 Vac, 47Hz to 63Hz

Input Current max: 18 A (rms): (2000 W at 115 Vac, 4000 W at 230 Vac)

10% overload short time: 19.8 A (rms) (2200 W at 115 Vac, 4400 W at 230 Vac)

Ambient temperature: < 50 C

Output Voltage: 387 Vdc +/- 5 Vdc

PWM Frequency: 66 kHz

Auxiliary Supply: 12 Vdc for bias voltage

Power dissipation in the GaN FET is limited by the maximum junction temperature. Refer to the [TP65H035G4WS](#) datasheet.

Figure 2 shows the input and output connections. To reduce EMI noise, adding a ferrite core at the input and output cable is recommended.

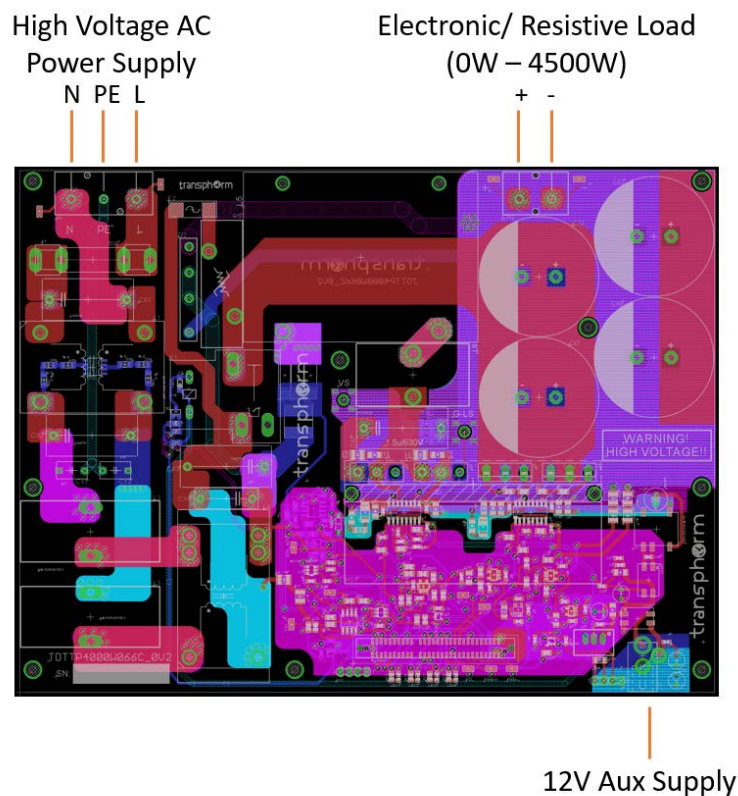

Figure 2. Input and output cable connections

TDTTP4000W066C User Guide

Circuit description for Bridgeless Totem-Pole PFC based on GaN FET

The Bridgeless totem-pole topology is shown in Figure 3 below. As shown in Fig 3(a), two GaN FETs and two diodes are used for the line rectification, while in Fig 3(b), the circuit is modified, and the diodes are replaced by two low resistance silicon MOSFETs to replace diode with IV drops to improve efficiency. Further information and discussion on the performance and the characteristics of Bridgeless PFC circuit is provided in [1].

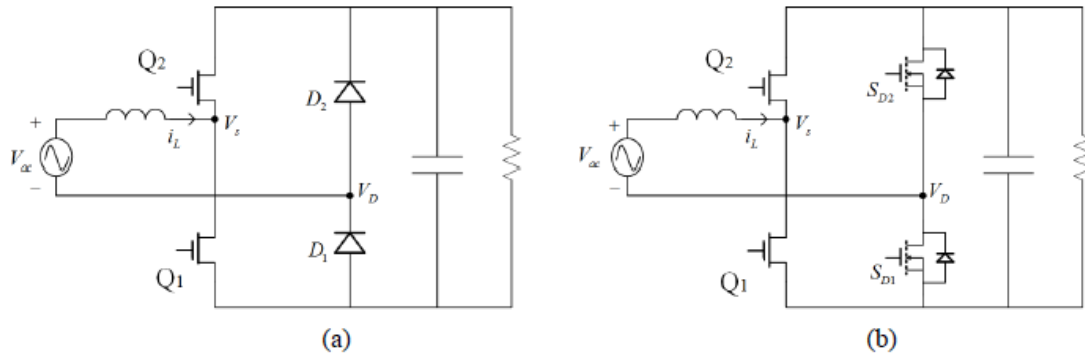

Figure 3: Totem-pole bridgeless PFC boost converter based on GaN FET (a) Diode for line rectification (b) MOSFET for line rectification

The large recovery charge (Q_{rr}) of existing silicon MOSFETs makes CCM operation of a silicon bridgeless totem-pole PFC impractical and reduces the total efficiency.

Figure 4(a) is a simplified schematic of a totem-pole PFC in continuous conduction mode (CCM) mode, focused on minimizing conduction losses. It comprises of two fast-switching GaN FETs (Q1 and Q2) operating at a high pulse-width-modulation (PWM) frequency and two very low-resistance MOSFETs (S1 and S2) operating at a much slower line frequency (50Hz/60Hz). The primary current path includes one fast switch and one slow switch only, with no diode drop. The function of S1 and S2 is that of a synchronized rectifier as illustrated in Figures 4(b) and 4(c). During the positive AC cycle, S1 is on and S2 is off, forcing the AC neutral line tied to the negative terminal to the DC output. The opposite applies for the negative cycle.

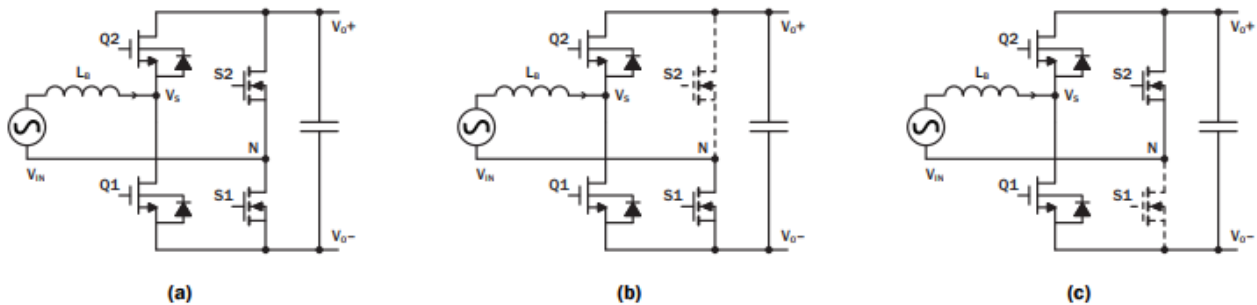

Figure 4. Totem-pole PFC with GaN FETs (a) simplified schematic, (b) during positive AC cycle and (c) during negative AC cycle

In either AC polarity, the two GaN FETs form a synchronized boost converter with one transistor acting as a master switch to allow energy intake by the boost inductor (LB), and the other transistor as a slave switch to release energy to the DC output. The roles of the two GaN devices interchange when the polarity of the AC input changes; therefore, each transistor must be able to perform both master and slave functions. To avoid shoot-through a dead time is built in between two switching events, during

TDTP4000W066C User Guide

which both transistors are momentarily off. To allow CCM operation, the body diode of the slave transistor must function as a flyback diode for the inductor current to flow during dead time. The diode current; however, must quickly reduce to zero and transition to the reverse blocking state once the master switch turns on. This is the critical process for a totem-pole PFC which with the high Q_{rr} of the body diode of high-voltage Si MOSFETs, results in abnormal spikes, instability, and associated high switching losses. The low Q_{rr} of the GaN switches allows designers to overcome this barrier.

As seen in Figure 5, inductive tests at 430 V shows clean voltage waveforms up to inductor current exceeding 35 A using either a high-side (Figure 5(a)) or low-side (Figure 5(b)) GaN transistor as a master switch. With a design goal of 4 kW output power in CCM mode with a 230 Vac input, the required inductor current is 20 A. This test confirms a successful totem-pole power block with enough current overhead.

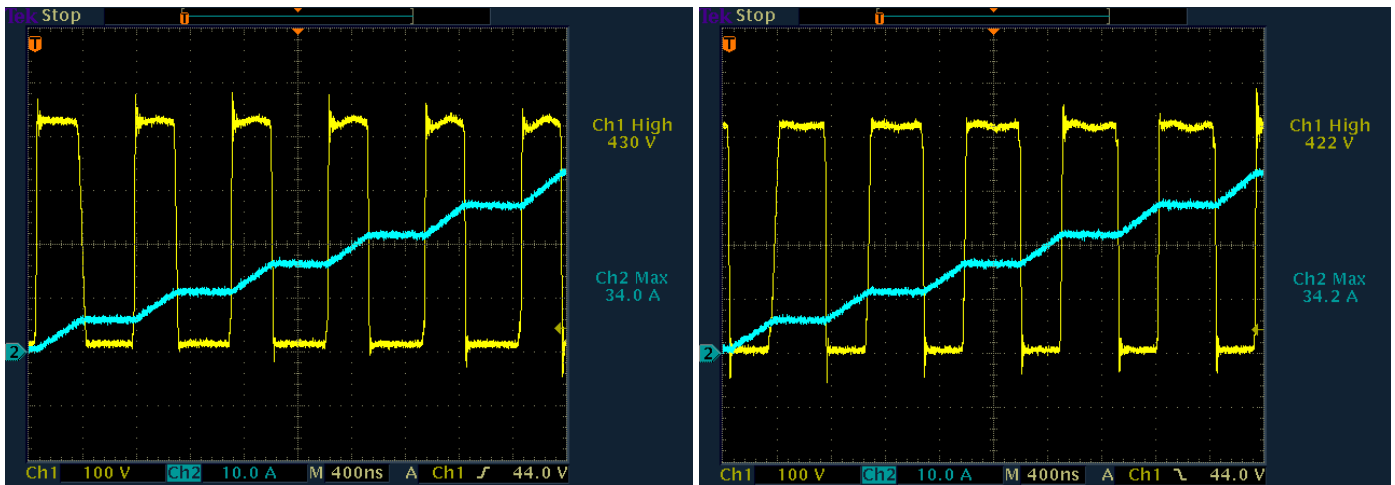

Figure 5. Hard-switched waveforms of a pair of GaN FET switches when setting a) high side as master and b) low side as master

One issue inherent in the bridgeless totem-pole PFC is the operation mode transition at AC voltage zero-crossing. For example, when the circuit operation mode changes from positive half-line to negative half-line at the zero-crossing, the duty ratio of the high-side GaN switch changes abruptly from almost 100% to 0% and the duty ratio of low-side GaN switch changes from 0% to 100%. Due to the slow reverse recovery of diodes (or body diode of a MOSFET), the voltage VDC cannot jump from ground to VDC instantly; and a current spike will be induced. To avoid the problem, a soft-start at every zero-crossing is implemented to gently reverse duty ratio (a soft-start time of a few switching cycles is enough). The TDTP4000W066C evaluation board is designed to run in CCM and the larger inductance alleviates the current spike issue at zero-crossing.

Dead time control

The required form of the gate-drive signals is shown in Figure 6. The times marked A are the dead times when neither transistor is driven on. The dead time must be greater than zero to avoid shoot-through currents. The Si8230 gate drive chip ensures a minimum dead time based on the value of resistor R24, connected to the DT input. The dead time in ns is equal to the resistance in $k\Omega \times 10$, so the default value of 12k corresponds to 120ns. This will add to any dead time already present in the input signals. The on-board pulse generator circuit; for example, creates dead times of about 60ns (see Figure 6). The resulting dead time at the gate pins of Q1 and Q2 is about 120ns. Either shorting or removing R7 will reduce the dead time to 60ns.

The dead time control can also be set on the firmware. See the FIRMWARE GUIDE for more information.

TDTP4000W066C User Guide

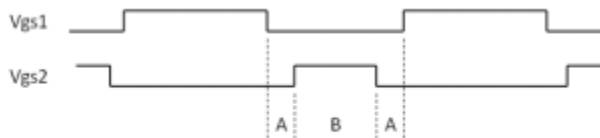

Figure 6. Non-overlapping gate pulses

While a typical Si MOSFET has a maximum dV/dt rating of 50V/ns, the TP65H035WSG4 GaN FET will switch at dV/dt of 100V/ns or higher to achieve the lowest possible switching loss. At this level of operation, even the layout becomes a significant contributor to performance. As shown in Figure 9, the recommended layout keeps a minimum gate drive loop and keeps the traces between the switching nodes very short—with the shortest practical return trace to the power bus and ground. The power ground plane provides a large cross-sectional area to achieve an even ground potential throughout the circuit. The layout carefully separates the power ground and the IC (small signal) ground, only joining them at the source pin of the FET to avoid any possible ground loop. Note that the Transphorm GaN FETs in TO-247 packages have a pinout configuration of G-S-D, versus the traditional G-D-S of a Si MOSFET. The G-S-D configuration is designed with thorough consideration to minimize the gate source driving loop, reducing parasitic inductance while separating the driving loop (gate source) and power loop (drain source) to minimize noise. All PCB layers of the TDTP4000W066C design are shown Figure 9(a-c) and available in the design files.

Design details

Detailed circuit schematics are shown in Figures 7 and 8, with the PCB layers shown in Figure 9, and the parts list in Table 1 (also included in the design files).

TDTP4000W066C User Guide

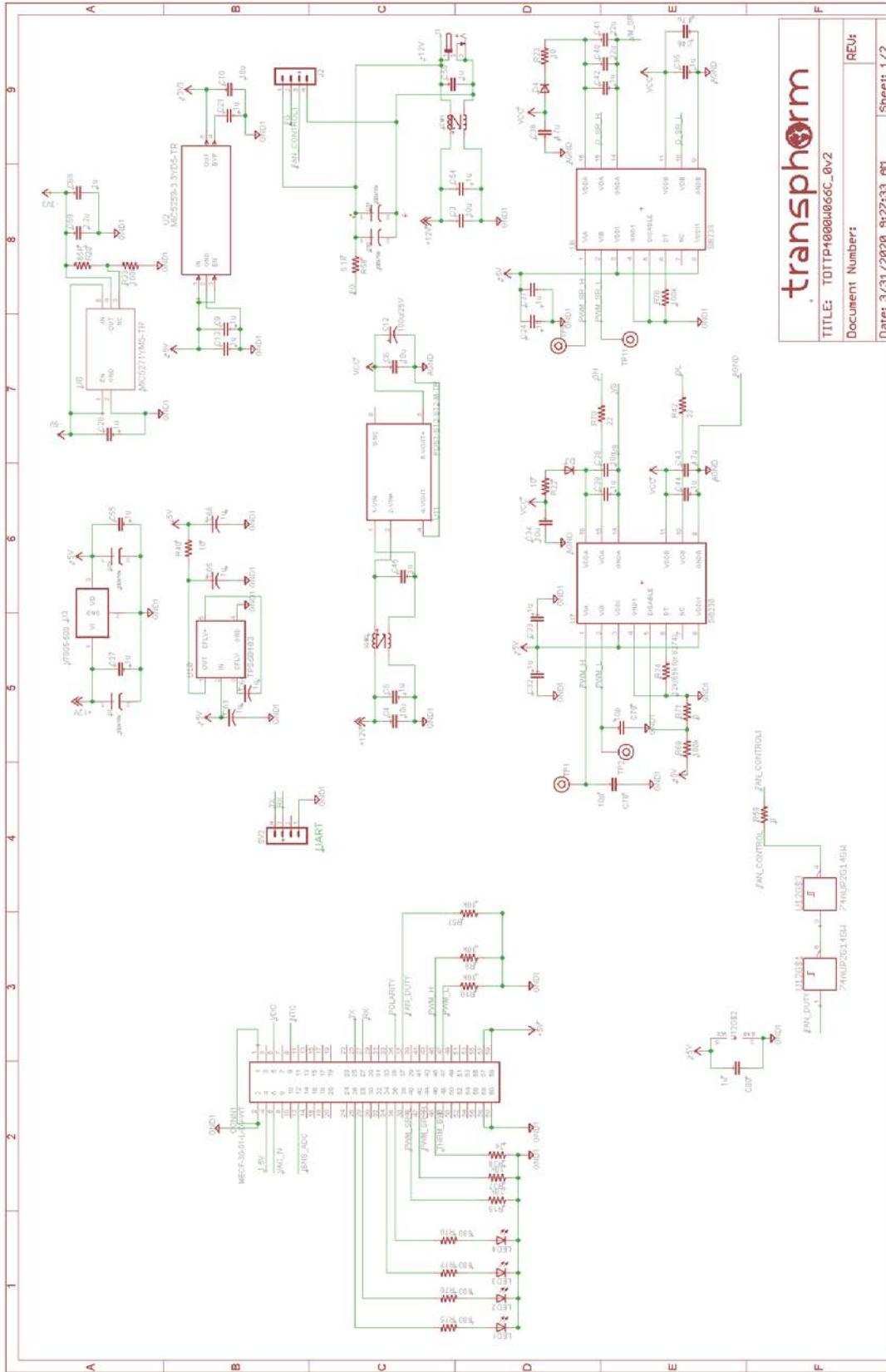

Figure 7: TDTP4000W066C Schematic - Page 1

TDTTP4000W066C User Guide

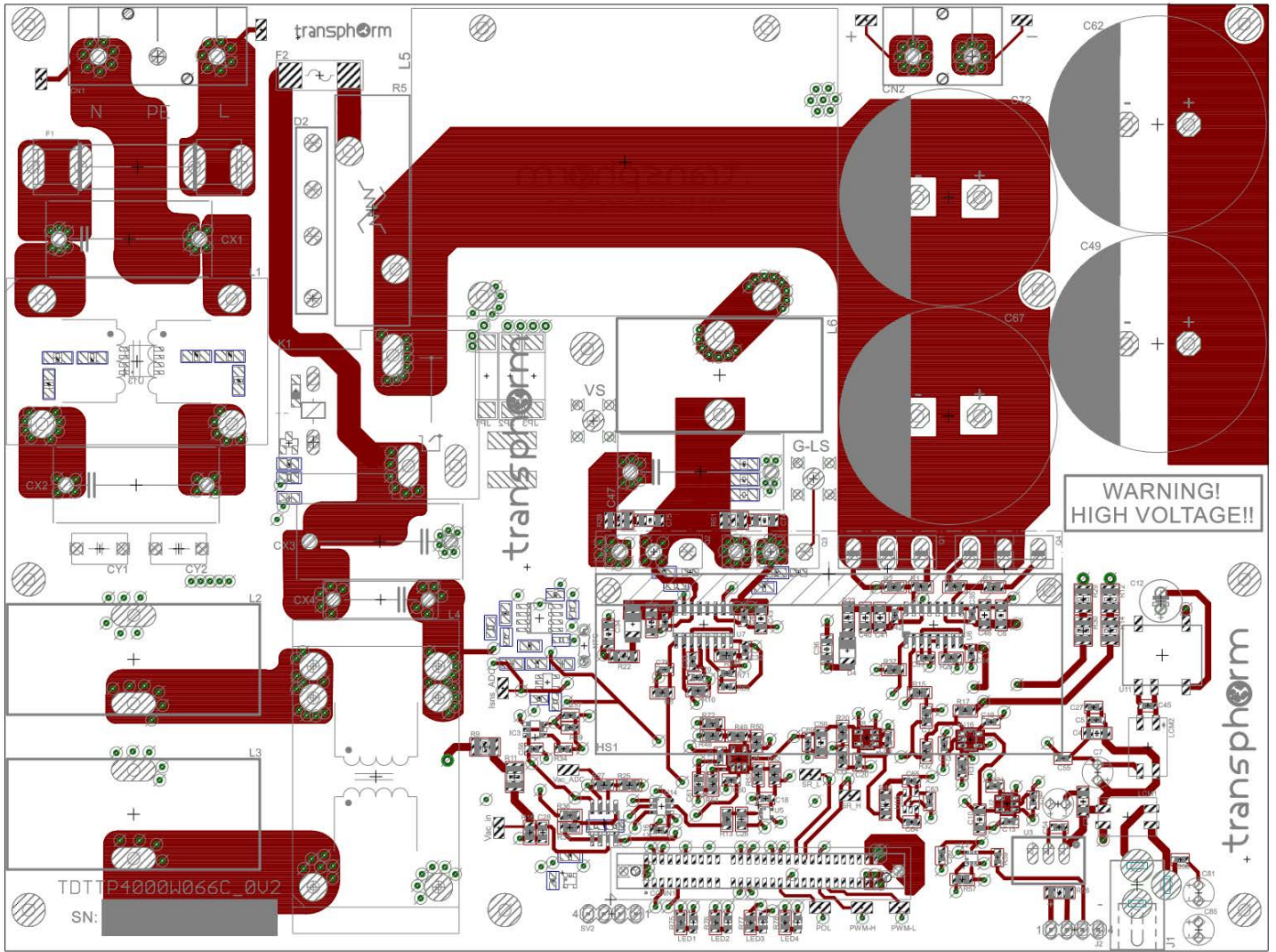

Figure 9a: PCB top layer

TDTTP4000W066C User Guide

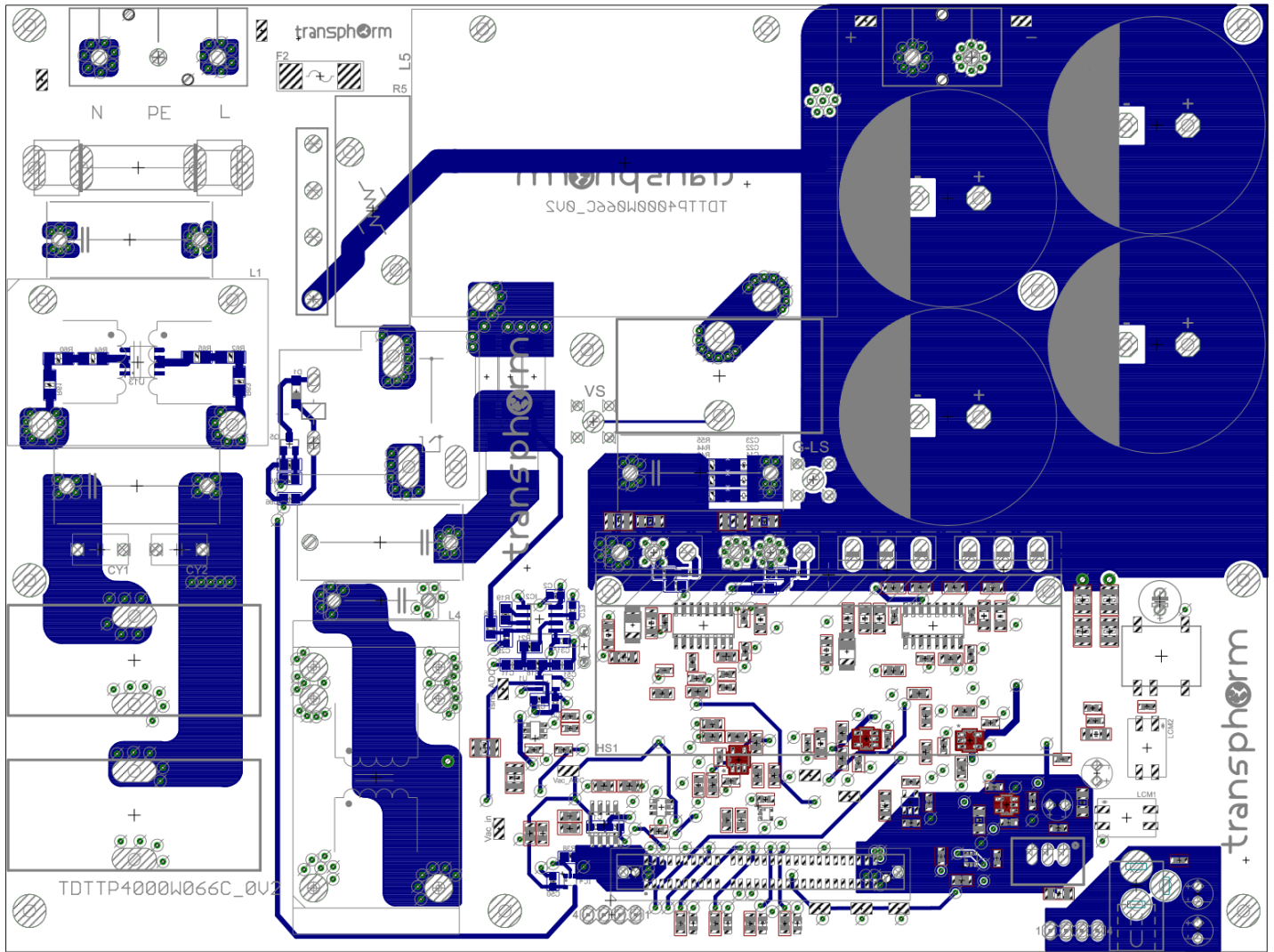

Figure 9b: PCB bottom layer

TDTTP4000W066C User Guide

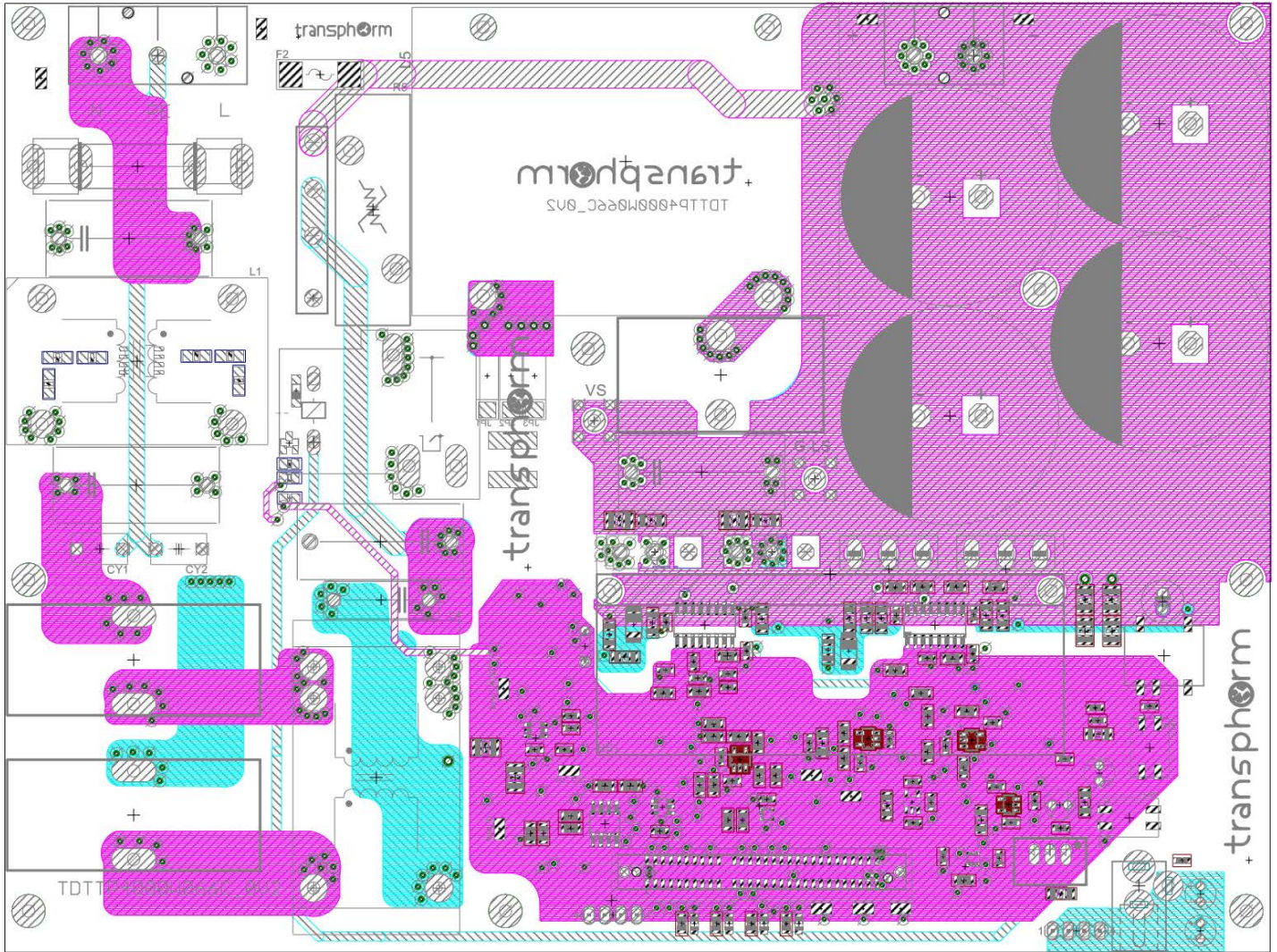

Figure 9c: PCB inner layer 2 (ground plane) + inner layer 3 (power plane)

TDTP4000W066C User Guide

TDTP4000W066C_OV2				
Qty	Value	Device	Parts	Manufacturer PN
2		DIODE-DO-214AC	D3, D4	ES1J
4		LEDCHIP-LED0805	LED1, LED2, LED3, LED4	SML-211UTT86
12		TESTPOINT-KEYSTONE5015	TP1, TP2, TP3, TP4, TP5, TP6, TP9, TP10, TP11, TP12, TP13, TP14	5015
30	.1u	C-EUC0603	C2, C5, C8, C9, C15, C16, C17, C18, C19, C20, C21, C24, C27, C30, C31, C32, C33, C35, C37, C39, C42, C44, C50, C52, C53, C54, C55, C56, C60, C73	C0603C104J3RACTU
2	0	R-US_R0603	R59, R71	RCS06030000Z0EA
1	0	R-US_R0805	R72	RC0805JR-070RL
6	1.1M	R-US_R1210	R9, R11, R12, R14, R29, R30	KTR25JZPF1104
1	1N4148	DIODE-SOD123	D1	1N4148W-E3-18
1	1k	R-US_R0805	R6	ERJ-6ENF1001V
2	1n	C-EUC0805	C26, C28	CC0805KRX7R9BB102
6	1u	C-EUC0603	C13, C45, C57, C58, C69, C80	TMK107B7105KA-T
4	1u	C-USC0603	C63, C64, C65, C66	TMK107B7105KA-T
1	100	R-US_R0603	R34	RC0603FR-07100RL
1	2.1k	R-US_R0805	R53	RC0805FR-072K1L
1	2.2M	R-US_R0805	R48	RMCF0805JT2M20
1	2.2u	C-EUC1206	C59	CL31B225KAHNNNE
1	2K	R-US_R0805	R46	ERJ-6ENF2001V
1	2k	R-US_R0805	R38	ERJ-6ENF2001V
4	3.3K .1%	R-US_R0805	R25, R27, R35, R36	ERA-6AEB332V
1	3.3n	C-EUC0805	C1	C0805C332K5RACTU
1	4.7k	R-US_R0805	R52	RC0805FR-074K7L
3	4.7u	C-EUC1206	C36, C43, C46	CL31B475KBHNNNE
1	4m	RES_CSSH2728	R_CS	CSSH2728FT4L00
1	5.1k	R-US_R1206	R58	RC1206FR-075K1L

TDTP4000W066C User Guide

1	5k	R-US_R0805	R49	RC0805FR-075K1L
1	7.5K	R-US_R0805	R13	ERJ-6ENF7501V
4	7.5k	R-US_R0805	R16, R17, R31, R32	RN73C2A7K5BTDF
1	9.09k	R-US_R0805	R19	RC0805FR-079K09L
2	10	R-US_R0805	R1, R3	ERJ-6GEYJ100V
6	10	R-US_R1206	R22, R23, R40, R43, R44, R55	ERJ-8ENF10R0V
1	392	R-US_R0603	R39	RC0603FR-07392RL
11	10k	R-US_R0805	R2, R4, R7, R8, R10, R15, R37, R45, R47, R50, R57	ERJ-6ENF1002V
3	10n	C-EUC1206	C14, C22, C23	SMK316B7103KF-T
2	10p	C-EUC0603	C78, C79	C0603C100K3GACTU
1	10u	C-EUC0805	C86	GRM21BR61E106KA73L
6	10u	C-EUC1206	C3, C4, C6, C10, C34, C38	12063D106KAT2A
1	12k(65k for 8274)	R-US_R0805	R24	RC0805FR-0712KL
2	15	R-US_R1210	R28, R51	RMCF1210FT15R0
3	15k	R-US_R0805	R18, R21, R54	RC0805FR-0715KL
2	22	R-US_R0805	R42, R70	ERJ-6GEYJ220V
1	22n	C-EUC0805	C61	C2012C0G1V223J060AC
2	22u	C-EUC1206	C40, C41	CL31X226KAHN3NE
6	37.4k	R-US_R1206	R60, R61, R62, R63, R64, R65	RC1206FR-0737K4L
2	220	FB0603	FB1, FB2	MMZ1608B221
2	47p	C-EUC1206	C74, C75	CC1206JKNPOZBN470
1	74AUP2G14GW	74AUP2G14GW	U12	NC7WZ14P6X
1	74LVC1G14GW	74LVC1G14GW	U5	NC7SZ14M5X
1	74LVC1G17GW	74LVC1G17GW	IC4	SN74LVC1G17DBVR
2	100k	R-US_R0805	R26, R33	ERJ-6ENF1003V
1	100p	C-EUC0603	C25	06035A101FAT2A
1	165K	R-US_R0805	R20	ERJ-6ENF1653V
2	220p	C-EUC0805	C11, C51	CC0805KRX7R9BB221
4	680	R-US_R0805	R75, R76, R77, R78	RC0805FR-07680RL
2	CMC_WURTH_744229	CMC_WURTH_744229	LCM1, LCM2	744229
1	FUSE-SMM-10A	FUSE-SMM	F2	0463015.ER

TDTTP4000W066C User Guide

1	INA826R	INA826R	IC2	INA826AID
3	JUMPER_S1621-46R	JUMPER_S1621-46R	JP1, JP2, JP3	S1621-46R
1	LT1719	LT1719	U14	LT1719CS6#TRMPBF
1	MCP1501T-18E/CHY	MCP1501T-18E/CHY	IC3	MCP1501T-18E/CHY
2	MCP6001T-E/OT	MCP6001T-E/OT	U4, U16	MCP6001T-E/OT
1	MECF-30-01-L-DV-WT	MECF-30-01-L-DV-WT	CONN1	MECF-30-01-L-DV-WT
1	MIC5259-3.3YD5-TR	MIC5259-3.3YD5-TR	U2	MIC5259-3.3YD5-TR
1	MIC5271YM5-TR	MIC5271YM5-TR	U8	MIC5271YM5-TR
1	CAP200DG	CAP200DG	U13	CAP200DG
1	NX3008NBK	NX3008NBK	Q5	NX3008NBK,215
1	OPA188	OPA188	U1	OPA188AIDBVT
1	OPA2188	OPA2188	IC1	OPA2188AIDR
1	PDS1-S12-S12-M-TR	PDS1-S12-S12-M-TR	U11	PDS1-S12-S12-M-TR
1	SI8230	SI8230	U7	SI8230BB-D-IS1
1	SI8233	SI8230	U6	SI8233BB-D-IS1
1	TPS60403	TPS60403	U10	TPS60403DBVR
1	5V DC-DC converter	V7805-500	U3	TR05S05
1	DSPIC33CK256MP506 DIGITAL POWER	DSPIC33CK256MP506 DIGITAL POWER		MA330048
9	stand off (nylon 1/2)	stand off (nylon 1/2)	stand off (nylon 1/2)	1902C
9	machine screw (ss 1/2)	machine screw (ss 1/2)	machine screw (ss 1/2)	9902
4	Thermal pad for Q2, Q3, Q1, Q4	Thermal pad for Q2, Q3, Q1, Q4	Thermal pad for Q2, Q3, Q1, Q4	4169G
2	screws for FETs to HS (Q2, Q3)	screws for FETs to HS (Q2, Q3)	screws for FETs to HS (Q2, Q3)	6/32
1		GBJ2506	D2	GBJ2506-BP
2		MA04-1	SV2, J2	961104-6404-AR
1		PJ-002AH	J1	PJ-002AH
2		TEKTRONIX-PCB	TP7, TP8	131-4353-00
3	1.5u/310Vac	155MKP275KG	CX1, CX2, CX3	890334026030cs
1	2PIN_9.53MM	2PIN_9.53MM	CN2	20020705-M021B01LF
1	3.9mH	CMC_42X27MM_SM	L1	T60405-R6128-X225
1	3PIN_9.53MM	3PIN_9.53MM	CN1	T70343500000G
2	4.7n	VY2_CAP_SAFETY	CY1, CY2	B32021A3472M
1	7.2mH	CMC_42X27MM	L4	T60405-R6128-X230
1	10k@25C	R-US_0204/5	NTC	B57703M103G40

TDTP4000W066C User Guide

1	10uH	FILM-CAP-C4ATGB_5100	C47	890334026030cs
1	22n	ECQ-U2A474ML22N	CX4	PME271M522MR30
1	30A	SH32	F1	01020078H
1	100k	R-US_R0603	R69	DNI
4	100u/16v	ELE_CAP_D5MM_P2MM	C7, C29, C81, C85	UKL1C101KPDANA
1	100u/25V	CPOL-USE2.5-7	C12	ESK107M025AC3AA
4	470uF	ELE_CAP_D35MM_P10MM	C49, C62, C67, C72	ELXS451VSN471MA45S
2	DM-TOROID770711	DM-TOROID770711	L2, L3	CWS-1SN-12606
1	G8P-1A4P-DC12	G8P-1A4P	K1	JTN1AS-PA-F-DC12V
1	HF-TOROID	HF-TOROID	L6	CWS-1SN-12554
1	HS-OMNI-41-75	HS-OMNI-41-75	HS1	OMNI-UNI-41-75
1	MS35_10015	MS35_10015	R5	MS32 10015-B
1	PFC_4KW	PFC_4KW	L5	019-8598-00R
2	IPW60R017C7XKSA1	IPW60R017C7XKSA1	Q1, Q4	IPW60R017C7XKSA1
2	TP65H035G4WS	TP65H035G4WS	Q2, Q3	TP65H035G4WS
1	power adaptor	power adaptor	power adaptor	SMI6B-12-4-P5R

Table 1. TDTP4000W066C evaluation board bill of materials (BOM)

For this evaluation board, the PFC circuit has been implemented on a 4-layer PCB. The GaN FET half-bridge is built with TP65H035G4WS (35 mΩ) devices by Transphorm, Inc. The slow Si switches are IPW60R017C7XKSA1 superjunction MOSFETs with 17 mΩ on-resistance. The inductor is made of a high flux core with the inductance of 480 uH and a dc resistance of 25 mΩ, designed to operate at 66 kHz. A simple 0.5 A rated high/low side driver IC (Si8230) with 0/12 V as on/off states directly drives each GaN FET. A dsPIC33CK256MP506 Digital Power PIM MA330048 handles the control algorithm. The voltage and current loop controls are similar to conventional boost PFC converter. The feedback signals are dc output voltage (V_O), ac input potentials (V_{ACP} and V_{ACN}) and inductor current (I_L). The input voltage polarity and RMS value are determined from V_{ACP} and V_{ACN} . The outer voltage loop output multiplied by $|V_{AC}|$ gives a sinusoidal current reference. The current loop gives the proper duty ratio for the boost circuit. The polarity determines how PWM signal is distributed to drive Q1 and Q2. A soft-start sequence with a duty ratio ramp is employed for a short period at each ac zero-crossing for better stability.

TDTTP4000W066C User Guide

Using the board

The board can be used for the evaluation of Transphorm TP65H035G4WS (35 mΩ) GaN FETs in a bridgeless totem-pole PFC circuit. It is not a complete circuit, but rather a building block.

Turn on Sequences:

- 1) Connect an Electronic / resistive load to the corresponding marking (CN2).
 - a. The requirement for the resistive load:
 - At 115 Vac input: 0 W and ≤ 2200 W
 - At 230 Vac input: 0 W and ≤ 4400 W
- 2) Connect Microchip PIM (MA330048) onto CONN1.
- 3) Connect the 12 Vdc auxiliary supply to the demo-board (included in the demo-kit package).
 - b. Verify auxiliary LD1 on Microchip PIM is illuminated and LD2 is flashing.
 - c. Verify both FANS attached to heatsink are running
- 4) With HV power off, connect the high-voltage AC power input to the corresponding marking (CN1) on the PCB;
 - d. -N and L (PE: potential ground)
- 5) Turn on the AC power input (85 Vac to 270 Vac; 50Hz – 60Hz)
 - e. Minimum power load for turn-on sequence is 350 W.
 - Monitor CN2 output voltage with Vdc meter to verify 385V +/- 5V is generated.

Turn off sequences:

- 1) Switch off the high-voltage AC power input;
- 2) Power off dc bias.
- 3) Verify Input and Output voltage = 0.

Notes on Operating Structure:

- 1) When Vac is first switched on, Vout will increase to 390 Vdc.
 - a. Note that all LEDs (LED1 – LED4) on TDTTP4000W066C board are OFF.
- 2) After startup is completed, LED1 will illuminate continuously to indicate normal operation.
 - a. Electronic / resistive load can be increased while AC supply is ON and board is functional.
 - b. Loads can be increased by 500W per step, up to the rated power for operation.
- 3) If OCP is triggered, LED3 and LED4 will blink continuously fast. A complete reset will need to be completed.
 - a. Complete reset instructions:
 - i. Switch off Vac.
 - ii. Remove 12V aux connector and reconnect 12V aux connector to EV board.
 - iii. Perform turn-on sequence procedure explained at top of page.
- 4) Note: At burst mode (load < 80W, Output voltage will reach 410Vdc)

TDTTP4000W066C User Guide

Operational Waveforms

Figures 10a and 10b below shows the converter start-up procedure. For the start-up, there are three phases to charge the DC bus to a reference voltage. In the beginning, the relay K1 is open, and DC bus capacitors are charged by input voltage through NTC and diode bridge. When the Vdc is over 100V, the relay K1 is closed to bypass the NTC, and the Vdc increase to the peak of the input voltage. After 100ms, the GaN FET leg is engaged in voltage closed-loop control, in which the DC bus voltage reference slowly increases to the rated voltage 385 Vdc. The NTC and diode bridge are applied in this circuit to avoid high inrush current flow through the GaN FETs.

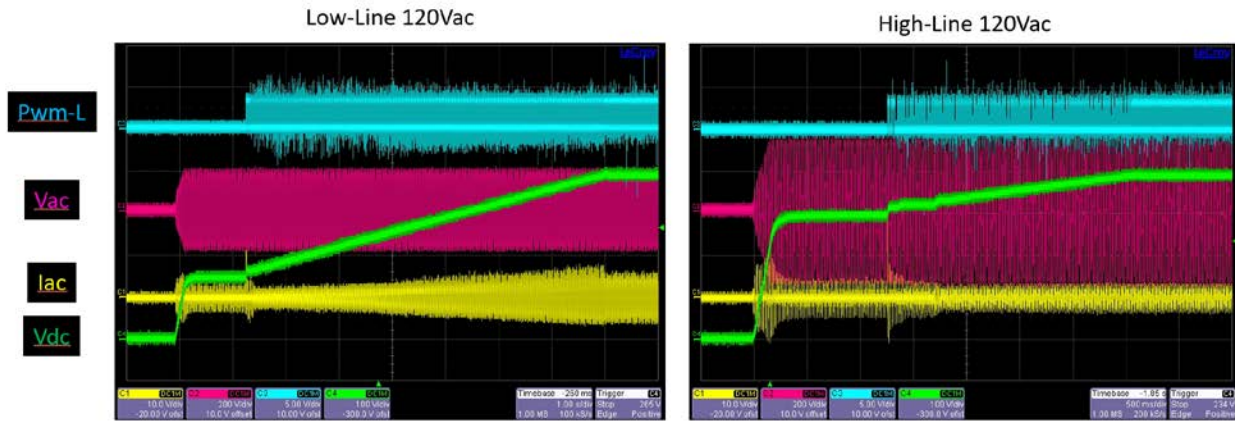

Figure 10a. Start-up of the bridgeless totem-pole PFC Low-Line and High-Line with 380 W load

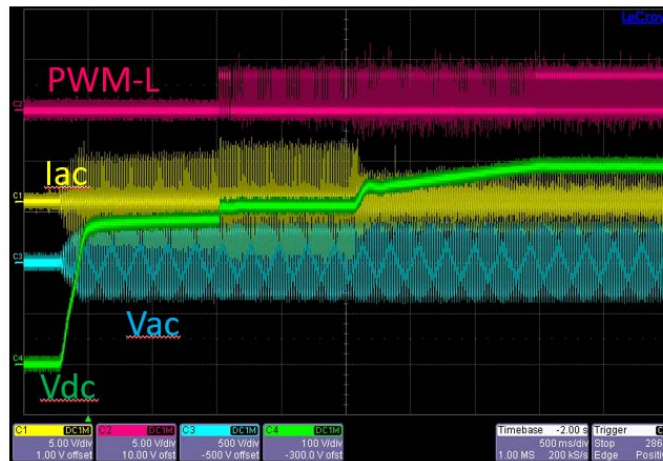

Figure 10b. Start-up of the Bridgeless totem-pole PFC High-Line with 1.2 kW load

TDTTP4000W066C User Guide

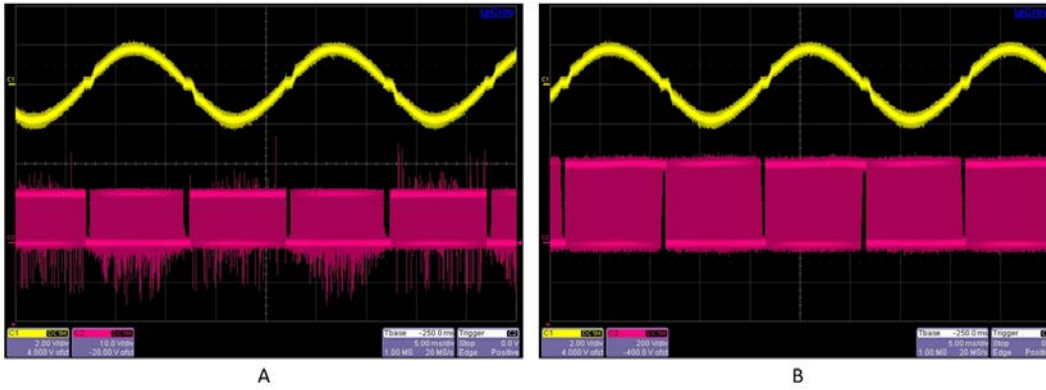

Figure 11a. Waveform of the active switch version of the Bridgeless totem-pole PFC at Low-line, 1.5 kW at Low-line

CH1: input current lin (2A/div) ; CH2: (a) Vgs of Q2 (10V/div), (b) Vds of Q2 (200V/div)

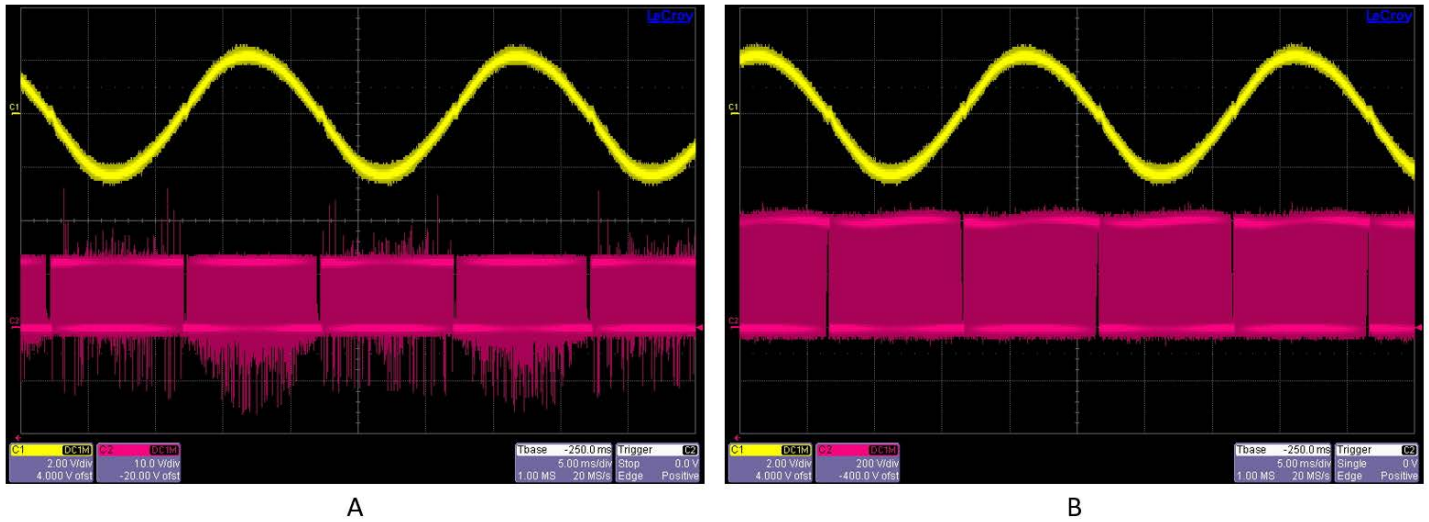

Figure 11b. Waveform of the active switch version of the Bridgeless totem-pole PFC at High-line, 3.5kW at High-line

CH1: input current lin (2A/div) ; CH2: (a) Vgs of Q2 (10V/div), (b) Vds of Q2 (200V/div)

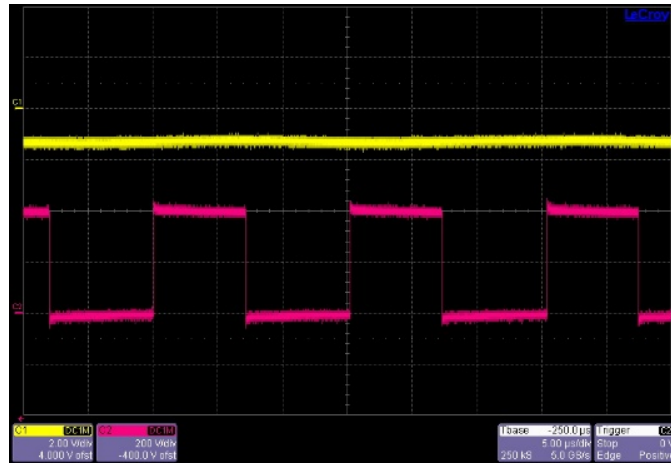

Figure 12. Waveforms of V_{ds} of Q3 at $I_{ac} = 16A$. CH1: input current I_{in} (2A/div) ; CH2: (a) V_{ds} (200V/div)

Probing

As shown in Fig 13 below, in the demo board, there are two probing sockets for customers measuring V_{gs} and V_{ds} of low-side Gan FET. By removing the jumpers and using a short wire to clamp the current probe, the PFC inductor can also be measured.

TDTTP4000W066C User Guide

There are two voltage probing sockets to measure V_{GS} and V_{DS} of the GaN FET shown below.

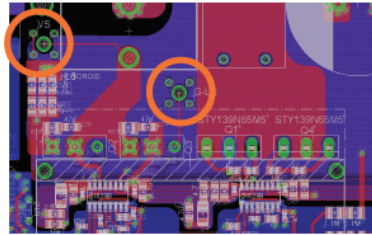
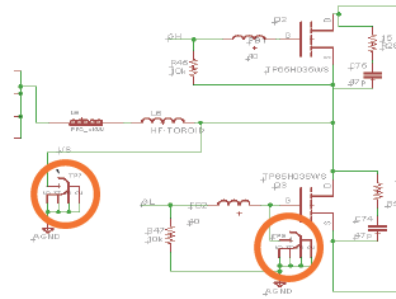

By removing the Jumpers and using a short wire to clamp the current probe, the PFC Inductor can also be measured.



Passive voltage probe

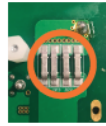

Remove jumpers and add a cable for inductor current measurement

Fig 13. V_{GS} and V_{DS} of low side GaN FET measurement socket tips, and PFC inductor current measuring position.

Efficiency Sweep and EMI

For the efficiency measurement, the input/output voltage and current will be measured for the input/output power calculation with a power analyzer. Efficiency has been measured at 120 Vac or 230 Vac input and 400 Vdc output using the WT1800 precision power analyzer from Yokogawa. The efficiency results for this Totem Pole PFC board are shown in Fig.14. The extremely high efficiency of 99% at 230Vac input, and > 98% at 120V ac input is the highest among PFC designs with similar PWM frequency; this high efficiency will enable customers to reach peak system efficiency to meet and exceed Titanium standards.

TDTTP4000W066C User Guide

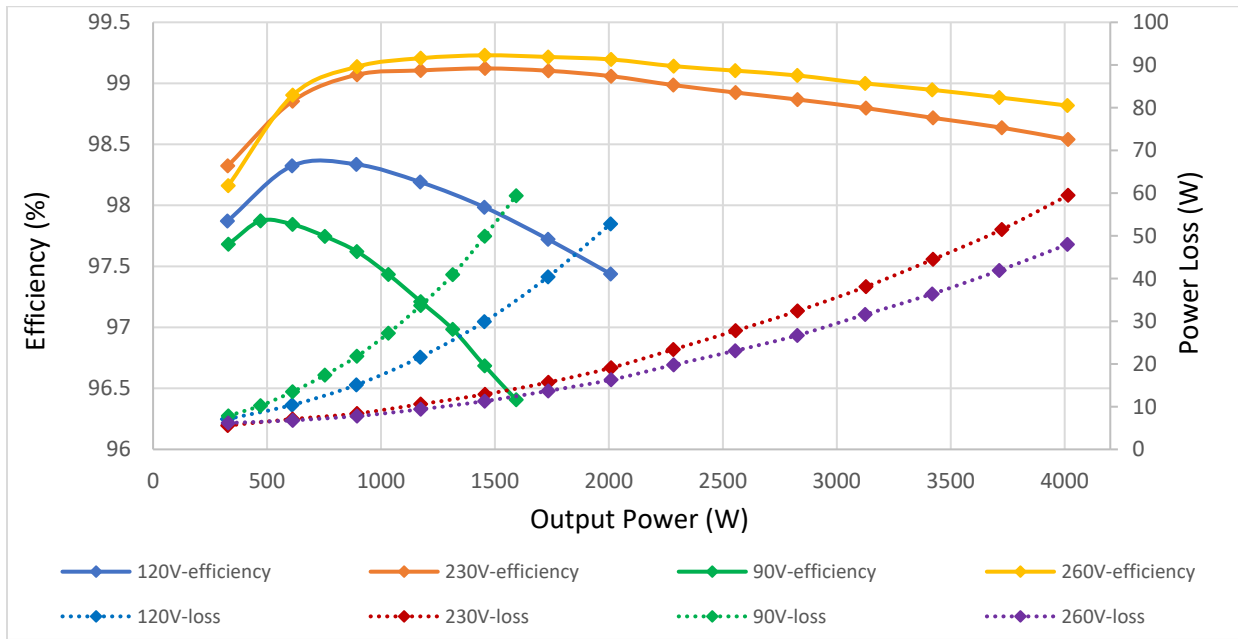

Figure 14. The efficiency results for Bridgeless Totem-pole PFC Evaluation Board.

Conducted emissions have also been measured for this board using an LIN-115A LISN by Com-Power. The results compared to EN55022A limits are shown in Fig. 15. It should be noted that the EMI test was done by using the lab-use power supply for auxiliary 12V source. **Do not use wall AC-DC adaptor for EMI test.**

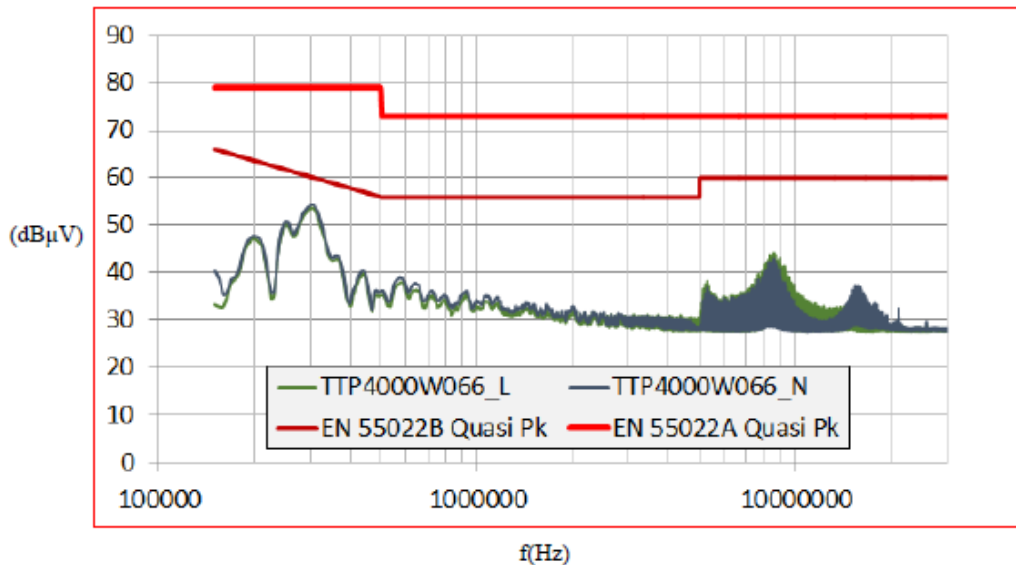

Fig 15. Conducted emissions @ 115V, 1150W

The THDi is measured using WT1800 at the condition of input THDv 3.8%. As shown in Fig 16 below, it meets the standard of IEC61000-3-12.

TDTP4000W066C User Guide

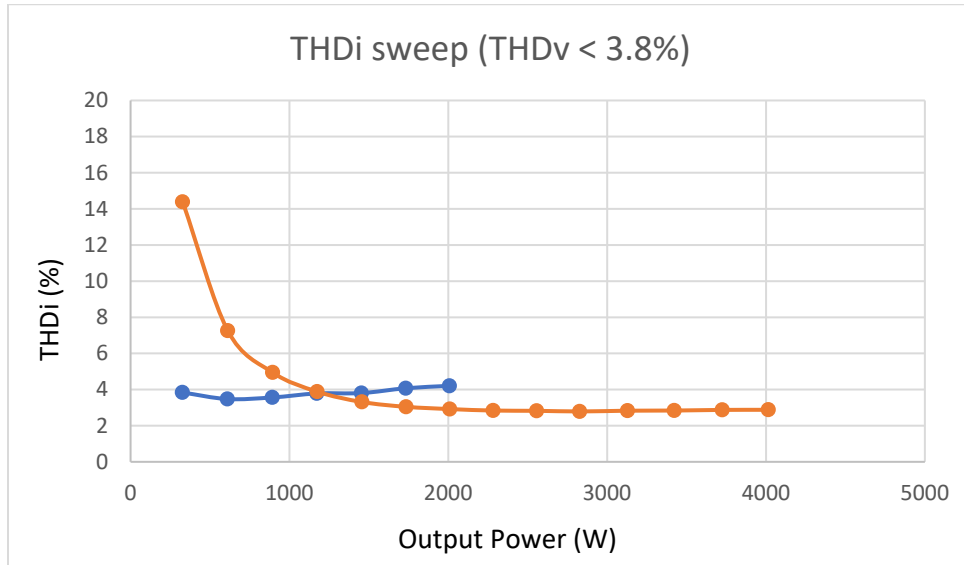

Fig 16. THDi meets IEC61000-3-12 (>16A)

Maximum Load Limit:

The TDTP4000W066C Bridgeless totem-pole PFC eval board is allowed to run overload in a short time. The rated input current for 230Vac input is 18A, and the 10% overload current can be 19.8A. The input OCP will be triggered when the current is over 21A.

WARNINGS:

This demo board is intended to demonstrate GaN FET technology. While it provides the main features of a totem-pole PFC, it is not intended to be a finished product and does not have all the protection features found in commercial power supplies. Along with this explanation go a few warnings which should be kept in mind:

1. An isolated AC source should be used as input; an isolated lab bench grade power supply or the included AUX DC supply should also be used for the 12V DC power supply. Float the oscilloscope by using an isolated oscilloscope or by disabling the PE (Protective Earth) pin in the power plug. Float the current probe power supply (if any) by disabling the PE pin in the power plug.
2. Use a resistive load only. The Totem-pole PFC kit can work at zero load with burst mode. The output voltage will be swinging between 375V and 385V during burst mode.
3. The demo board is not fully tested at large load steps. **DO NOT** apply a very large step in the load (>2000W) when it is running.
4. **DO NOT** manually probe the waveforms when the demo is running. Set up probing before powering up the demo board.
5. The auxiliary Vdc supply must be 12 V. The demo board will not work under, for example, 10 V or over 15V Vdc.

TDTP4000W066C User Guide

6. **DO NOT** touch any part of the demo board when it is running.
7. When plugging the control cards into the socket, make sure the control cards are fully pushed down with a clicking sound.
8. If the demo circuit goes into protection mode it will work as a diode bridge by shutting down all PWM functions. Recycle the bias power supply to reset the DSP and exit protection mode.
9. **DO NOT** use a passive probe to measure control circuit signals and power circuit signals in the same time. GND1 and AGND are not the same ground.
10. To get clean Vgs of low side GaN FET, it is recommended not to measure the Vds at the same time.
11. It is not recommended using passive voltage probe for Vds, Vgs measurement and using differential voltage probe for Vin measure measurement at the same time unless the differential probe has very good dv/dt immunity.

REFERENCE:

- [1]. Liang Zhou, Yi-Feng Wu and Umesh Mishra, "True Bridgeless Totem-pole PFC based on GaN FETs", PCIM Europe 2013, 14-16 May, 2013, pp.1017-1022.
- [2]. L. Huber, Y. Jang, and M. M. Jovanovic, "Performance evaluation of Bridgeless PFC boost rectifiers," IEEE Transactions on Power Electronics, Vol. 23, No. 3, pp. 1381-1390, May 2008.

Mouser Electronics

Authorized Distributor

Click to View Pricing, Inventory, Delivery & Lifecycle Information:

[Transphorm:](#)

[TDTP4000W066C-KIT](#)