

Wideband RF PLL fractional/integer frequency synthesizer with integrated VCOs and LDOs

Datasheet - production data

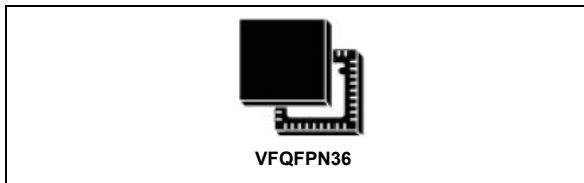

Features

- Output frequency range: 46.875 to 6000 MHz
- Very low noise
 - Normalized in band phase noise floor: -227 dBc/Hz
 - VCO phase noise: -135 dBc/Hz @ 1 MHz offset, 4.0 GHz carrier
 - Noise floor: -160 dBc/Hz
- Dual architecture frequency synthesizer: Fractional-N and Integer-N
- Integrated VCOs with automatic center frequency calibration
- Programmable RF output dividers by 1/2/4/8/16/32/64
- Dual RF Output broadband matched with programmable power level and mute function
- External VCO option with 5 V charge pump
- Integrated low noise LDO voltage regulators
- Maximum phase detector frequency: 100 MHz
- Exact frequency mode
- Fast lock and cycle slip reduction
- Differential reference clock input (LVDS and LVECPL compliant) supporting up to 800 MHz
- 13-bit programmable reference frequency divider
- Programmable charge pump current
- Digital lock detector
- Integrated reference crystal oscillator core
- R/W SPI interface
- Logic compatibility/tolerance 1.8 V/3.3 V

- Low power functional mode
- Supply voltage: 3.0 V to 5.4 V
- Small size exposed pad VFQFPN36 package 6 x 6 x 1.0 mm
- Process: BICMOS 0.25 μ m SiGe

Applications

- Cellular/4G infrastructure equipment
- Instrumentation and test equipment
- Cable TV
- Other wireless communication systems

Table 1. Device summary

Order Code	Package	Packing
STW81200T	VFQFPN36	Tray
STW81200TR	VFQFPN36	Tape and reel

Description

The STW81200 is a dual architecture frequency synthesizer (Fractional-N and Integer-N), that features three low phase-noise VCOs with a fundamental frequency range of 3.0 GHz to 6.0 GHz and a programmable dual RF output divider stage which allows coverage from 46.875 MHz to 6 GHz.

The STW81200 optimizes size and cost of the final application thanks to the integration of low-noise LDO voltage regulators and internally-matched broadband RF outputs.

The STW81200 is compatible with a wide range of supply voltages (from 3.0 V to 5.4 V) providing to the end user a very high level of flexibility which trades off excellent performance with power dissipation requirements. A low-power functional mode (software controlled) gives an extra power saving.

Additional features include crystal oscillator core, external VCO mode and output-mute function.

Contents

1	Functional block diagram	6
2	Pin definitions	7
3	Absolute maximum ratings	10
4	Operating conditions	11
5	Electrical specifications	13
6	Typical performance characteristics	19
7	Circuit description	24
7.1	Reference input stage	24
7.2	Reference divider	24
7.3	PLL N divider	25
7.3.1	Fractional spurs and compensation mechanism	26
7.4	Phase frequency detector (PFD)	27
7.5	Lock detect	28
7.6	Charge pump	28
7.7	Fast lock mode	29
7.8	Cycle slip reduction	29
7.9	Voltage controlled oscillators (VCOs)	29
7.10	RF output divider stage	30
7.11	Low-power functional modes	31
7.12	LDO voltage regulators	32
7.13	STW81200 register programming	33
7.14	STW81200 register summary	35
7.15	STW81200 register descriptions	36
7.16	Power ON sequence	51
7.17	Example of register programming	51

8	Application information	52
8.1	Application diagrams	52
8.2	Thermal PCB design considerations	54
9	Evaluation kit	55
10	Package information	56
10.1	VFQFPN36 package information	56
11	Revision history	59

List of figures

Figure 1.	Functional block diagram	6
Figure 2.	Top view	7
Figure 3.	VCO open-loop phase noise (5 V supply)	19
Figure 4.	Closed-loop phase noise at 4.8 GHz, divided by 1 to 64 (5 V supply)	19
Figure 5.	VCO open-loop phase noise at 4.4 GHz vs. supply	19
Figure 6.	VCO open-loop phase noise over frequency vs. supply	19
Figure 7.	Single sideband integrated phase noise vs. frequency and supply ($F_{\text{PFD}} = 50 \text{ MHz}$)	20
Figure 8.	Figure of merit	20
Figure 9.	Phase noise and fractional spurs at 2646.96 MHz vs. supply ($F_{\text{PFD}} = 61.44 \text{ MHz}$)	20
Figure 10.	Phase noise and fractional spurs at 2118.24 MHz vs. supply ($F_{\text{PFD}} = 61.44 \text{ MHz}$)	20
Figure 11.	Phase noise and fractional spurs at 2118.24 MHz at 5.0 V supply ($F_{\text{PFD}} = 61.44 \text{ MHz}$)	20
Figure 12.	Phase noise and fractional spurs at 2118.24 MHz at 3.6 V supply ($F_{\text{PFD}} = 61.44 \text{ MHz}$)	20
Figure 13.	Phase noise and fractional spurs at 2118.24 MHz at 3.0 V supply ($F_{\text{PFD}} = 61.44 \text{ MHz}$)	21
Figure 14.	Phase noise at 5.625 GHz and 4.6 GHz ($F_{\text{PFD}} = 50 \text{ MHz}$)	21
Figure 15.	Typical VCO control voltage after VCO calibration (3.6 V supply)	21
Figure 16.	Average K_{VCO} over VCO frequency and supply	21
Figure 17.	Output power level vs. temperature - single ended ($\text{RF_OUT_PWR}=7$)	21
Figure 18.	Output power level – single ended (3 dB more for differential)	21
Figure 19.	Typical spur level at PFD offset over carrier frequency (5.0 V supply)	22
Figure 20.	Typical spur level vs. offset from 4.5 GHz (5.0 V supply, $F_{\text{PFD}}=50\text{MHz}$)	22
Figure 21.	10 kHz fractional spur (integer boundary) vs. temperature (5.0 V supply, $F_{\text{PFD}} = 50 \text{ MHz}$)	22
Figure 22.	800 kHz fractional spur (integer boundary) vs. temperature (5.0 V supply, $F_{\text{PFD}} = 50 \text{ MHz}$)	22
Figure 23.	Frequency settling with VCO calibration – wideband view	22
Figure 24.	Frequency settling with VCO calibration – narrowband view	22
Figure 25.	Overall current consumption vs. temperature (5.0 V supply, $F_{\text{PFD}} = 50 \text{ MHz}$)	23
Figure 26.	Current consumption – standard vs. low power (5.0 V supply, $F_{\text{PFD}} = 50 \text{ MHz}$)	23
Figure 27.	Current consumption – standard vs. low power (3.6 V supply, $F_{\text{PFD}} = 50 \text{ MHz}$)	23
Figure 28.	Current consumption – standard vs. low power (3.0 V supply, $F_{\text{PFD}} = 50 \text{ MHz}$)	23
Figure 29.	Reference clock buffer configurations: single-ended (A), differential (B), crystal mode (C)	24
Figure 30.	PFD diagram	28
Figure 31.	SPI Protocol	33
Figure 32.	SPI timing diagram	34
Figure 33.	Application diagram (internal VCO)	52
Figure 34.	Application diagram (external VCO)	53
Figure 35.	VFQFPN - 36 pin, 6x6 mm, 0.5 mm pitch very thin profile fine pitch quad flat package outline	56
Figure 36.	VFQFPN - 36 pin, 6x6 mm, 0.5 mm pitch very thin profile fine pitch quad flat package recommended footprint	58

List of tables

Table 1.	Device summary	1
Table 2.	Pin description	8
Table 3.	Absolute maximum ratings	10
Table 4.	Operating conditions	11
Table 5.	Digital logic levels	12
Table 6.	Electrical specifications	13
Table 7.	Phase noise specifications	17
Table 8.	Current value vs. selection	29
Table 9.	Blocks with programmable current and related performance	31
Table 10.	SPI timings	34
Table 11.	SPI Register map (address 12 to 15 not available)	35
Table 12.	STW81200 order codes	55
Table 13.	VFQFPN - 36 pin, 6x6 mm, 0.5 mm pitch very thin profile fine pitch quad flat package mechanical data	57
Table 14.	Document revision history	59

1 Functional block diagram

Figure 1. Functional block diagram

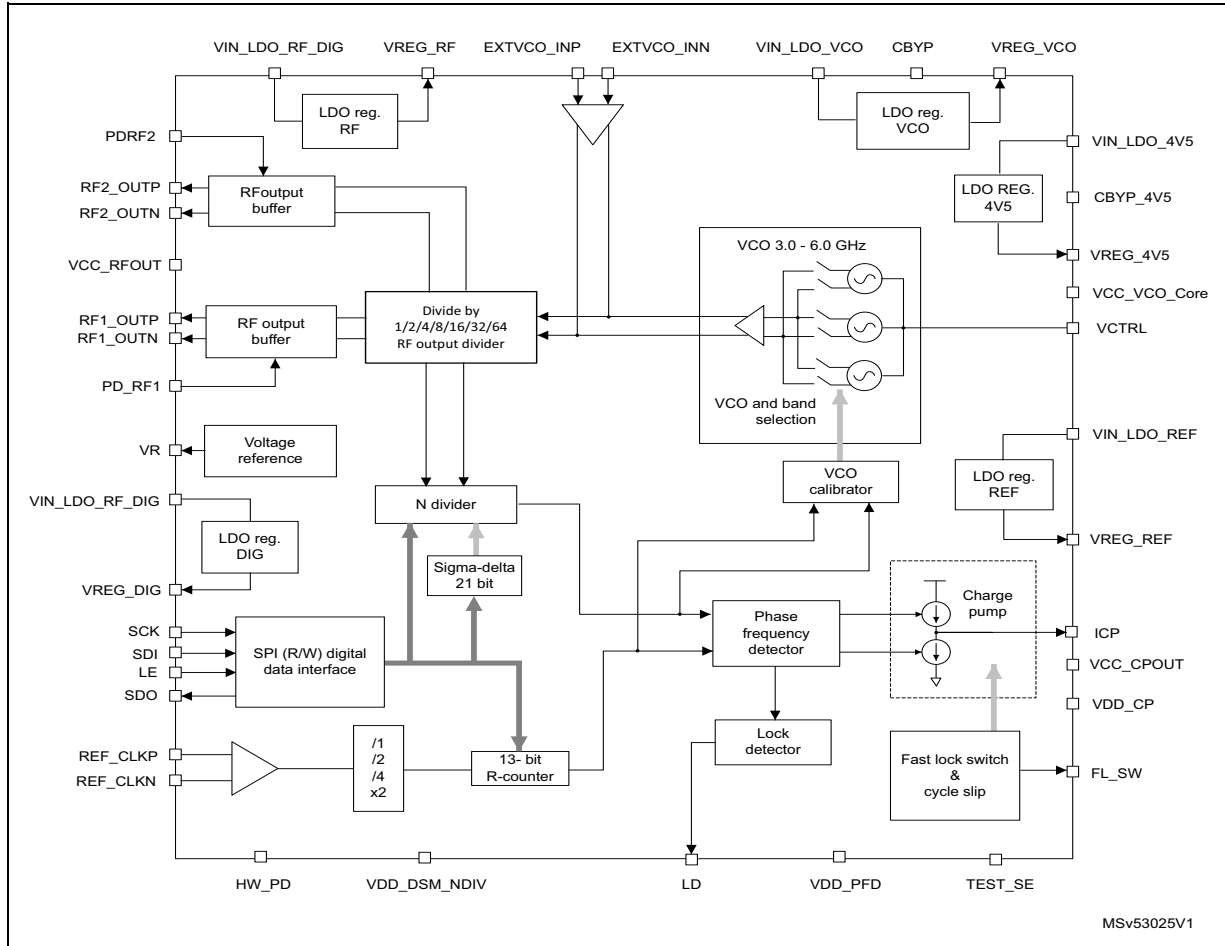

Table 2. Pin description

Pin No	Name	Description	Observation
1	CBYP_4V5	Connection for 4.5 V regulator bypass capacitor	-
2	VREG_4V5	Regulated output voltage for 4.5V regulator	Adjustable output voltage: 5.0 V, 4.5 V, 2.6 V, 3.3 V
3	VCC_VCO_Core	Supply voltage for VCO Core	Must be connected to VREG_4V5 or VREG_VCO
4	HW_PD	HW Power Down	CMOS Schmitt Triggered Input, 1.8 V compatible, 3.3 V tolerant
5	PD_RF1	RF1 output stage Power Down control	CMOS Schmitt Triggered Input, 1.8 V compatible, 3.3 V tolerant
6	PD_RF2/FL_SW	RF2 output stage Power Down Control / Fast Lock switch	CMOS Schmitt Triggered Input, 1.8 V compatible, 3.3V tolerant (with Fast lock feature disabled); High impedance/ GND shorted output (with Fast Lock feature enabled)
7	CBYP	Connection for VCO circuitry regulator bypass capacitor	-
8	VREG_VCO	Regulated output voltage for VCO circuitry regulator	-
9	VIN_LDO_VCO	Supply voltage for VCO circuitry regulator	-
10	VR	Connection for reference voltage filtering capacitor	-
11	VCTRL	VCO control voltage	-
12	EXTVCO_INP	External VCO positive input	This pin must be connected to ground if external VCO is not used
13	EXTVCO_INN	External VCO negative input	This pin must be connected to ground if external VCO is not used
14	VDD_CP	Supply voltage for Charge Pump bias	This pin must be connected to VREG_VCO
15	ICP	PLL charge pump output	-
16	VCC_CPOUT	Supply voltage for Charge Pump output stage	This pin must be connected to VREG_4V5 or VREG_VCO
17	VDD_PFD	Supply voltage for PFD	This pin must be connected to VREG_REF
18	VIN_LDO_REF	Supply voltage for PLL regulator	-
19	VREG_REF	Regulated output voltage for Reference Clock regulator	-
20	REF_CLKN	Reference clock negative input	-
21	REF_CLKP	Reference clock positive input	-

Table 2. Pin description (continued)

Pin No	Name	Description	Observation
22	LD_SDO	Lock Detector/SPI Data output	CMOS push-pull Output 2.5V with slew rate control or open drain (1.8V to 3.3V tolerant)
23	SDI	SPI Data input	CMOS Schmitt triggered Input, 1.8 V compatible, 3.3 V tolerant
24	SCK	SPI clock	CMOS Schmitt triggered Input, 1.8 V compatible, 3.3 V tolerant
25	LE	SPI load enable	CMOS Schmitt triggered Input, 1.8 V compatible, 3.3 V tolerant
26	VDD_DSM_NDIV	Supply voltage for DSM and N divider	This pin must be connected to VREG_DIG
27	VREG_DIG	Regulated output voltage for digital circuitry regulator	-
28	VIN_LDO_RF_DIG	Supply voltage for RF Output divider stage and digital regulators	-
29	VREG_RF	Regulated output voltage for RF Output Divider stage regulator	-
30	RF1_OUTN	Main RF negative output	50 Ω output impedance
31	RF1_OUTP	Main RF positive output	50 Ω output impedance
32	VCC_RFOUT	Supply voltage for RF Output stages	Connected to VREG_DIV, VREG_4V5 or external 5V
33	RF2_OUTN	Auxiliary RF negative output	50 Ω output impedance
34	RF2_OUTP	Auxiliary RF positive output	50 Ω output impedance
35	TEST_SE	Test pin	This pin must be connected to ground
36	VIN_LDO_4V5	Supply voltage for 4.5 V regulator	-

3 Absolute maximum ratings

Table 3. Absolute maximum ratings

Symbol	Parameter	Value	Unit
VCC	Supply voltage pins #14, #17, #26	-0.3 to 2.7	V
	Supply voltage LDOs pins #9, #18, #28, #36	-0.3 to 5.4	V
	Supply voltage pins #3	-0.3 to 5	V
	Supply voltage pins #16, #32	-0.3 to 5.4	V
Tstg	Storage temperature	+150	°C
ESD	Electrical Static Discharge HBM ⁽¹⁾	2	kV
	CDM-JEDEC Standard	0.5	
	MM	0.2	

1. The maximum rating of the ESD protection circuitry on pin 21 (REF_CLKP) is 1.5 kV.

4 Operating conditions

Table 4. Operating conditions

Symbol	Parameter	Test conditions	Min	Typ	Max	Unit
V _{CC}	Supply voltage pins #14, #17, #26	-	2.5	-	2.7	V
	Supply voltage (LDOs inputs) pins #9, #18, #28, #36	-	3.0	-	5.4	V
	Supply voltage pin #3, #16, #32	-	2.5	-	5	V
I _{CC}	Current Consumption Pin #3, #16 and #32 supplied at 4.5 V	DIV2 ON, Main Output only, 4 GHz VCO, max. performance	-	84	-	mA
	Current Consumption Pin #3, #16 and #32 supplied at 2.6 V		-	50	-	mA
	Current consumption other blocks an supplies at 2.6 V		-	110	-	mA
T _A	Operating ambient temperature	-	-40	-	85	°C
T _J	Maximum junction temperature	-	-	-	125	°C
Θ _{JA}	Junction to ambient package thermal resistance ⁽¹⁾	Multilayer JEDEC board	-	33	-	°C/W
Θ _{JB}	Junction to board package thermal resistance ⁽¹⁾	Multilayer JEDEC board	-	18	-	°C/W
Θ _{JC}	Junction to case package thermal resistance ⁽¹⁾	Multilayer JEDEC board	-	3	-	°C/W
Ψ _{JB}	Thermal characterization parameter junction to board ⁽¹⁾	Multilayer JEDEC board	-	17	-	°C/W
Ψ _{JT}	Thermal characterization parameter junction to top case ⁽¹⁾	Multilayer JEDEC board	-	0.3	-	°C/W

1. Refer to JEDEC standard JESD 51-12 for a detailed description of the thermal resistances and thermal parameters. Data here presented are referring to a Multilayer board according to JEDEC standard.

$$T_J = T_A + \Theta_{JA} * P_{diss} \text{ (in order to estimate } T_J \text{ if ambient temperature } T_A \text{ and dissipated power } P_{diss} \text{ are known)}$$

$$T_J = T_B + \Psi_{JB} * P_{diss} \text{ (in order to estimate } T_J \text{ if ambient temperature } T_B \text{ and dissipated power } P_{diss} \text{ are known)}$$

$$T_J = T_T + \Psi_{JT} * P_{diss} \text{ (in order to estimate } T_J \text{ if ambient temperature } T_T \text{ and dissipated power } P_{diss} \text{ are known)}$$

Table 5. Digital logic levels

Symbol	Parameter	Test conditions	Min	Typ	Max	Unit
Vdd	Internal Supply for digital circuits	-	-	2.6	-	V
Vil	Low level input voltage	Schmitt input	0	-	0.6	V
Vih	High level input voltage	Schmitt input	1.2	-	3.6	V
Vol	Low level output voltage	$I_{OL} = 4 \text{ mA}$	-	-	0.2	V
Voh	High level output voltage	$I_{OH} = 4 \text{ mA}$	Vdd-0.2	-	-	V

5 Electrical specifications

All electrical specifications are given at 25°C T_{AMB} and in a full-current mode, unless otherwise stated.

Table 6. Electrical specifications

Symbol	Parameter	Condition	Min	Typ	Max	Units
Output frequency range						
F _{OUT}	Output Frequency	Direct output	3000	-	6000	MHz
		Divider by 2 output	1500	-	3000	MHz
		-	...	MHz
		Divider by 64 output	46.875	-	93.75	MHz
VCO dividers						
N	VCO Divider Ratio	Integer Mode	24	-	131071	-
		Fractional mode (DSM 1 st Order)	24	-	510	-
		Fractional mode (DSM 2 nd Order)	25	-	509	-
		Fractional mode (DSM 3 rd Order)	27	-	507	-
		Fractional mode (DSM 4 st Order)	31	-	503	-
Xtal oscillator						
F _{XTAL}	XTAL frequency range	-	10	-	50	MHz
ESR _{XTAL}	XTAL ESR	-	-	-	50	Ω
P _{XTAL}	XTAL Power Dissipation	-	-	-	5	mW
C _{INXTAL}	XTAL Oscillator Input capacitance	Single ended	0.6	-	-	pF
PN _{XTAL}	XTAL Oscillator Phase Noise Floor	50 MHz XTAL	-	-162	-	dBc/Hz
TOL _{XTAL}	XTAL Oscillator accuracy	@12 MHz, 25 °C	-	-	10	ppm
Reference clock and phase frequency detector						
F _{ref}	Reference input frequency ⁽¹⁾	-	10	-	800	MHz
	Reference input sensitivity	Differential Mode	0.2	1	1.25	Vp
		Single Ended Mode	0.35	1	1.25	Vp
PN _{REFIN}	Reference Input Buffer Phase Noise Floor	Single Ended Mode @100 MHz, sinusoidal signal 1.25 Vp	-	-163	-	dBc/Hz
		LVDS signal @100 MHz 400 mVp	-	-159	-	dBc/Hz

Table 6. Electrical specifications (continued)

Symbol	Parameter	Condition	Min	Typ	Max	Units
I _{REF}	Current consumption ⁽²⁾	Differential Mode	-	10	-	mA
		Single Ended Mode	-	3	-	
		XTAL oscillator Mode	-	5	-	
R	Reference Divider Ratio	-	1	-	8191	
F _{PFD}	PFD input frequency ⁽³⁾	-	-	-	100	MHz
F _{STEP}	Frequency step ⁽³⁾	LO direct output	-	47.5	-	Hz
		LO with divider by 2	-	23.75	-	Hz
		...	-	...	-	Hz
		LO with divider by 64	-	0.7422	-	Hz
Charge pump						
V _{CCCP}	CP Supply	Pin # 16 (VCC_CP)	2.5	-	5	V
I _{CP}	ICP sink/source	5-bit programmable	-	-	4.9	mA
V _{ICP}	Output voltage range on ICP pin (pin#14)	-	0.4	-	V _{CCCP} -0.4	V
-	Comparison frequency Spurs ⁽⁴⁾	-	-	-85	-	dBc
-	In-Band Fractional Spurs ⁽⁵⁾	-	-	-50	-	
VCOs						
V _{CCVCO}	VCO Core Supply	Pin # 3 (VCC_VCO_Core)	2.5	-	5	V
I _{VCO}	Oscillator Core current consumption	@ 4 GHz and 4.5 V supply	-	52	-	mA
		@ 4 GHz and 3.3 V supply	-	35	-	
		@ 4 GHz and 2.6 V supply	-	30	-	
I _{VCOBUF}	VCO buffer consumption	Pin # 3 (VCC_VCO_Core)	-	35	-	mA
K _{VCO}	VCO gain	-	-	35-95	-	MHz/V
ΔT _{LK}	Maximum temperature variation for continuous lock ⁽⁶⁾⁽⁷⁾	Pin #16 @4.5/5 V	-125	-	125	°C
		Pin #16 @3.3 V	-125	-	125	°C
		Pin #16 @2.6 V	-125	-	115	°C
RF output stage						
V _{CCRF}	RF Output supply	Pin # 35 (VCC_RFOUT)	2.5	-	5	V
P _{OUT}	Output level	Differential 3.3 V to 5 V supply	-1	-	+7	dBm
	-	Differential 2.6 V supply	-1	-	+1	
Z _{OUT}	Output impedance	Differential	-	100	-	Ω
		Single Ended	-	50	-	Ω
R _L	Return Loss	Matched to 50-ohm Single Ended	-	15	-	dB

Table 6. Electrical specifications (continued)

Symbol	Parameter	Condition	Min	Typ	Max	Units
H ₂	LO 2 nd Harmonic	Direct output (single/differential)	-	-30/-40	-	dBc
		Divided output (single/differential)	-	-30/-35	-	dBc
H ₃	LO 3 rd Harmonic	Direct output (single/differential)	-	-15/-15	-	dBc
		Divided output (single/differential)	-	-15/-15	-	dBc
P _{MUTE}	Level of Signal with RF Mute Enabled	Direct output @4 GHz (single/diff)	-	-45/-60	-	dBm
		Divided output @2 GHz (single/diff)	-	-45/-60	-	dBm
P _{ISO}	Main/aux port isolation	Direct output @4 GHz (single/diff)	-	-35/-40	-	dBc
		Divided output @2 GHz (single/diff)	-	-40/-45	-	dBc
I _{DIV}	RF Divider Current Consumption ⁽⁸⁾	Direct output (1 differential output)	-	28	-	mA
		DIV2 buff (1 differential output)	-	47	-	
		DIV4 buff (1 differential output)	-	56	-	
		DIV8 buff (1 differential output)	-	65	-	
		DIV16 buff (1 differential output)	-	75	-	
		DIV32 buff (1 differential output)	-	83	-	
		DIV64 buff (1 differential output)	-	92	-	
		Auxiliary path enabled	-	19	-	
I _{RFOUTBUF}	RF Output Buffer Current Consumption ⁽⁸⁾	3.3 V to 5 V supply (1 differential output; P _{OUT} = +7 dBm)	-	25	-	mA
		3.3 V to 5 V Auxiliary path enabled	-	25	-	
		2.6 V supply (1 differential output; P _{OUT} = +1 dBm)	-	12	-	
		2.6 V Auxiliary path enabled	-	12	-	

Table 6. Electrical specifications (continued)

Symbol	Parameter	Condition	Min	Typ	Max	Units
PLL miscellaneous						
I_{PLL}	PLL current Consumption ⁽⁸⁾	Prescaler, digital dividers, misc.	-	20	-	mA
I_{DSM}	$\Delta\Sigma$ Modulator current consumption ⁽⁸⁾	-	-	3.5	-	mA

1. The maximum frequency of the Reference Divider is 200 MHz; when using higher reference clock frequency (up to the max. value of 800 MHz) the internal divider by 2 or divider by 4 must be enabled.
The fractional mode is allowed in the full frequency range only with reference clock frequency >11.93 MHz
With reference clock frequency in the range 10 MHz to 11.93 MHz, due to the limits of N value in fractional mode, the full VCO frequencies would not be addressed in fractional mode; in this case the frequency doubler in the reference path can be enabled.
2. Reference clock signal @ 100 MHz, R=2
3. The minimum frequency step is obtained as $F_{PFD} / (2^{21})$; these typical values are obtained considering $F_{PFD} = 100$ MHz.
4. PFD frequency leakage.
5. This is the level inside the PLL loop bandwidth due to the contribution of the $\Delta\Sigma$ Modulator. In order to obtain the fractional spurs level for a specific frequency offset, the attenuation provided by the loop filter at such offset should be subtracted.
6. Once a VCO is programmed at the initial temperature T_0 inside the operating temperature range (-40 °C to +85 °C), the synthesizer is able to maintain the lock status only if the temperature drift (in either direction) is within the limit specified by ΔT_{LK} , provided that the final temperature T_f is still inside the nominal range.
7. In order to guarantee the performance of ΔT_{LK} the bit CAL_TEMP_COMP in register ST6 must be set to '1'.
8. Current consumption measured with PLL locked in following conditions: Reference clock signal @ 100 MHz; PFD @50 MHz (R=2); VCO @ 4005 MHz

Table 7. Phase noise specifications

Parameter	Min	Typ	Max	Units
Normalized In-Band Phase Noise ⁽¹⁾ Floor ⁽²⁾	-	-227	-	dBc/Hz
VCO Open Loop Phase Noise⁽¹⁾ at F_{OUT} @ 4 GHz – VIN=5.0 V, VREG=4.5 V				
Phase Noise @ 1 kHz	-	-64	-	dBc/Hz
Phase Noise @ 10 kHz	-	-91	-	dBc/Hz
Phase Noise @ 100 kHz	-	-114	-	dBc/Hz
Phase Noise @ 1 MHz	-	-135	-	dBc/Hz
Phase Noise @ 10 MHz	-	-154	-	dBc/Hz
Phase Noise @ 100 MHz	-	-160	-	dBc/Hz
VCO Open Loop Phase Noise⁽¹⁾ at F_{OUT} @ 4 GHz/2 = 2GHz – VIN=5.0 V, VREG=4.5 V				
Phase Noise @ 1 kHz	-	-70	-	dBc/Hz
Phase Noise @ 10 kHz	-	-97	-	dBc/Hz
Phase Noise @ 100 kHz	-	-120	-	dBc/Hz
Phase Noise @ 1 MHz	-	-141	-	dBc/Hz
Phase Noise @ 10 MHz	-	-156	-	dBc/Hz
Phase Noise @ 40 MHz	-	-159	-	dBc/Hz
VCO Open Loop Phase Noise⁽¹⁾ at F_{OUT} @ 4 GHz/4 = 1 GHz – VIN=5.0 V, VREG=4.5 V				
Phase Noise @ 1 kHz	-	-76	-	dBc/Hz
Phase Noise @ 10 kHz	-	-103	-	dBc/Hz
Phase Noise @ 100 kHz	-	-126	-	dBc/Hz
Phase Noise @ 1 MHz	-	-146	-	dBc/Hz
Phase Noise @ 10 MHz	-	-159	-	dBc/Hz
Phase Noise Floor	-	-160	-	dBc/Hz
VCO Open Loop Phase Noise⁽¹⁾ at F_{OUT} @ 4 GHz/32 = 125 MHz – VIN=5.0 V, VREG=4.5 V				
Phase Noise @ 1 kHz	-	-92	-	dBc/Hz
Phase Noise @ 10 kHz	-	-121	-	dBc/Hz
Phase Noise @ 100 kHz	-	-144	-	dBc/Hz
Phase Noise @ 1 MHz	-	-161	-	dBc/Hz
Phase Noise @ 10 MHz	-	-163	-	dBc/Hz
Phase Noise Floor	-	-164	-	dBc/Hz

Table 7. Phase noise specifications

Parameter	Min	Typ	Max	Units
VCO Open Loop Phase Noise⁽¹⁾ at F_{OUT} @ 4 GHz – VIN=3.6V , VREG=3.3 V				
Phase Noise @ 1 kHz	-	-62	-	dBc/Hz
Phase Noise @ 10 kHz	-	-89	-	dBc/Hz
Phase Noise @ 100 kHz	-	-113.2	-	dBc/Hz
Phase Noise @ 1 MHz	-	-133.6	-	dBc/Hz
Phase Noise @ 10 MHz	-	-152.4	-	dBc/Hz
Phase Noise @ 100 MHz	-	-158.5	-	dBc/Hz
VCO Open Loop Phase Noise⁽¹⁾ at F_{OUT} @ 4 GHz – VIN=3.0 V, VREG=2.6 V				
Phase Noise @ 1 kHz	-	-60.5	-	dBc/Hz
Phase Noise @ 10 kHz	-	-88	-	dBc/Hz
Phase Noise @ 100 kHz	-	-110.3	-	dBc/Hz
Phase Noise @ 1 MHz	-	-131	-	dBc/Hz
Phase Noise @ 10 MHz	-	-150	-	dBc/Hz
Phase Noise @ 100 MHz	-	-157	-	dBc/Hz

1. Phase Noise SSB unless otherwise specified. The VCO Open loop figures are specified at 4.5/5 V on VCC_VCO_Core (pin #3).
2. Normalized PN = Measured PN – 20log(N) – 10log(F_{PFD}) where N is the VCO divider ratio and F_{PFD} is the comparison frequency at the PFD input.

6 Typical performance characteristics

Figure 3. VCO open-loop phase noise (5 V supply)

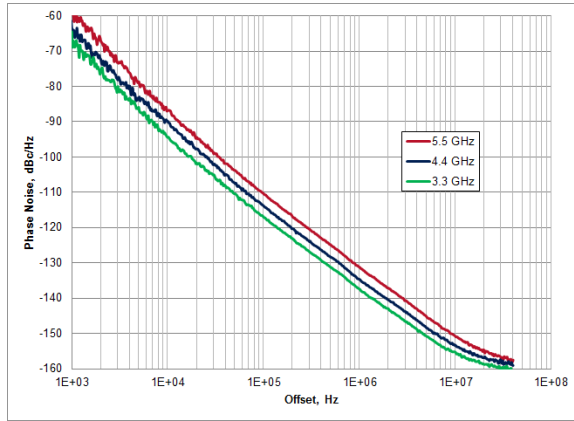

Figure 4. Closed-loop phase noise at 4.8 GHz, divided by 1 to 64 (5 V supply)

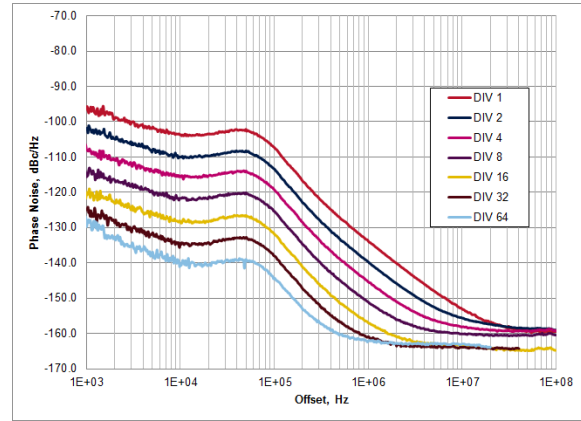

Figure 5. VCO open-loop phase noise at 4.4 GHz vs. supply

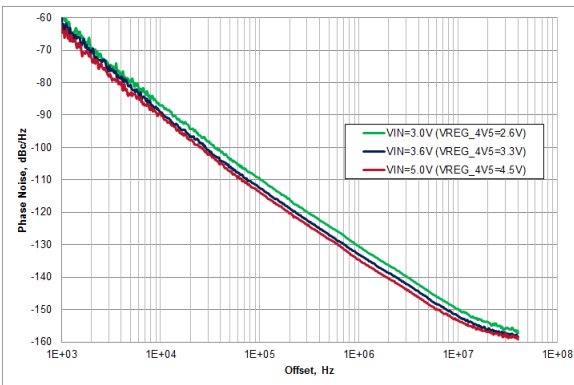

Figure 6. VCO open-loop phase noise over frequency vs. supply

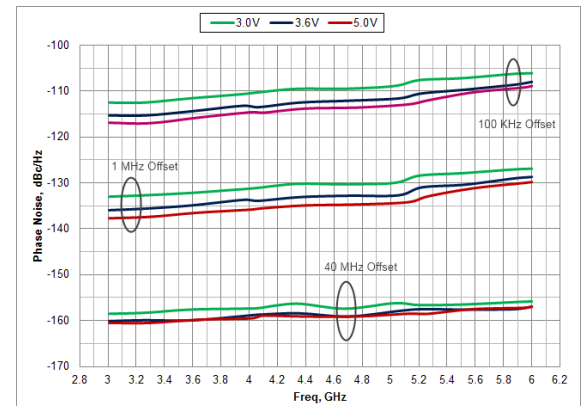

Figure 7. Single sideband integrated phase noise vs. frequency and supply ($F_{PFD} = 50$ MHz)

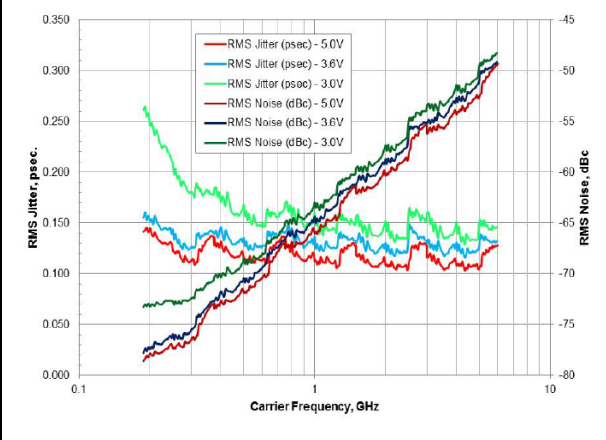

Figure 8. Figure of merit

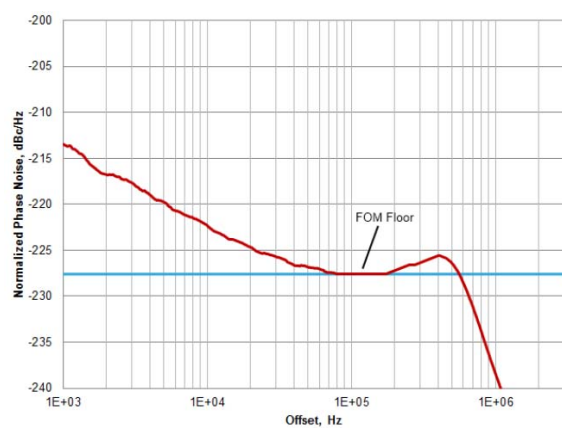

Figure 9. Phase noise and fractional spurs at 2646.96 MHz vs. supply ($F_{PFD} = 61.44$ MHz)

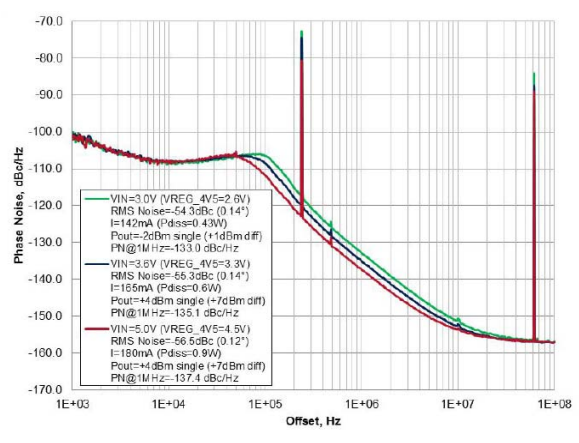

Figure 10. Phase noise and fractional spurs at 2118.24 MHz vs. supply ($F_{PFD} = 61.44$ MHz)

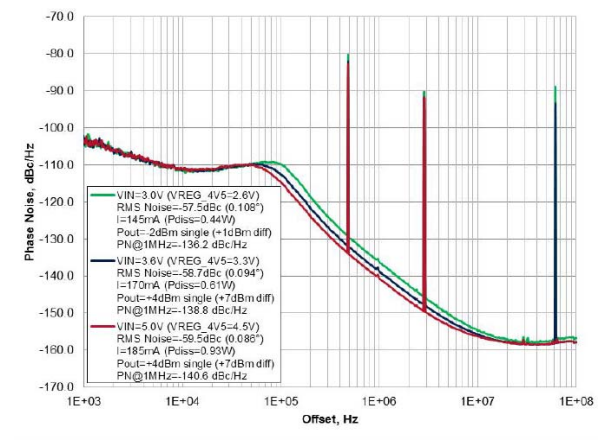

Figure 11. Phase noise and fractional spurs at 2118.24 MHz at 5.0 V supply ($F_{PFD} = 61.44$ MHz)

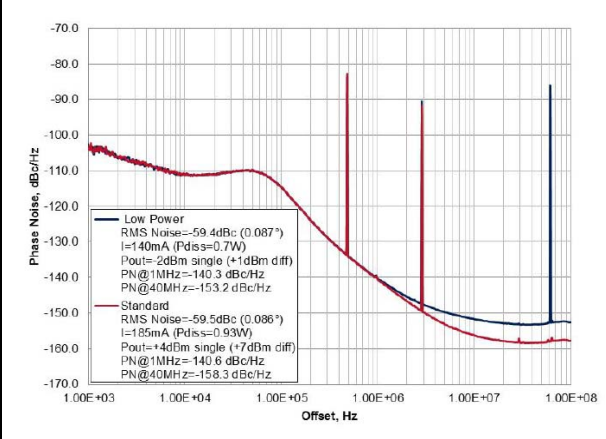

Figure 12. Phase noise and fractional spurs at 2118.24 MHz at 3.6 V supply ($F_{PFD} = 61.44$ MHz)

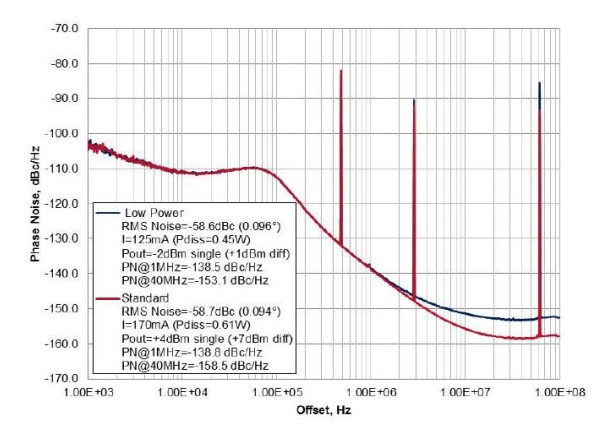

Figure 13. Phase noise and fractional spurs at 2118.24 MHz at 3.0 V supply ($F_{PFD} = 61.44$ MHz)

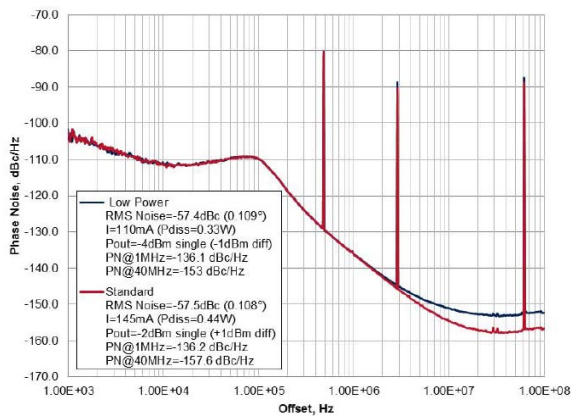

Figure 14. Phase noise at 5.625 GHz and 4.6 GHz ($F_{PFD} = 50$ MHz)

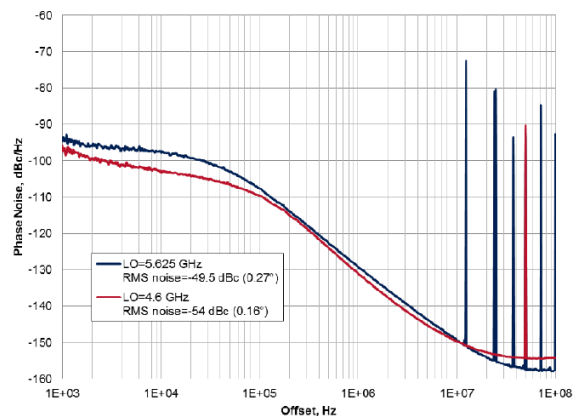

Figure 15. Typical VCO control voltage after VCO calibration (3.6 V supply)

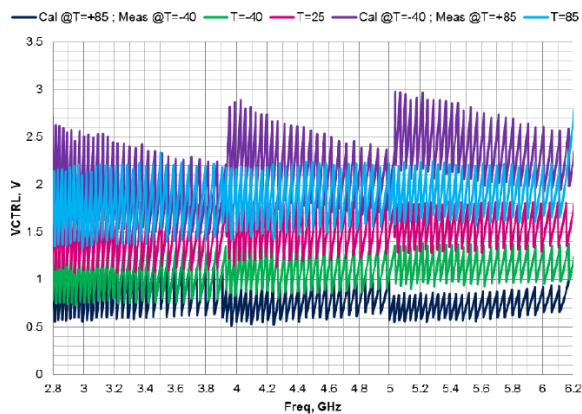

Figure 16. Average K_{VCO} over VCO frequency and supply

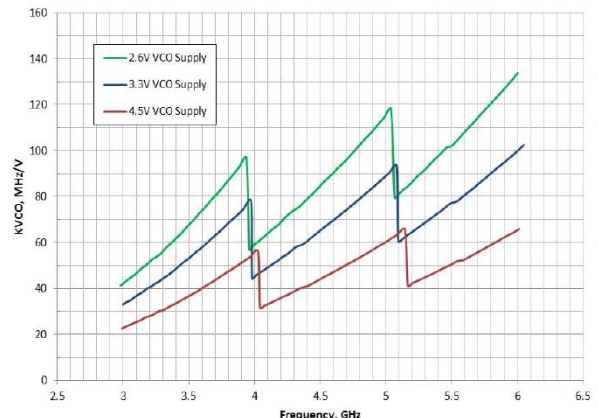

Figure 17. Output power level vs. temperature - single ended (RF_OUT_PWR=7)

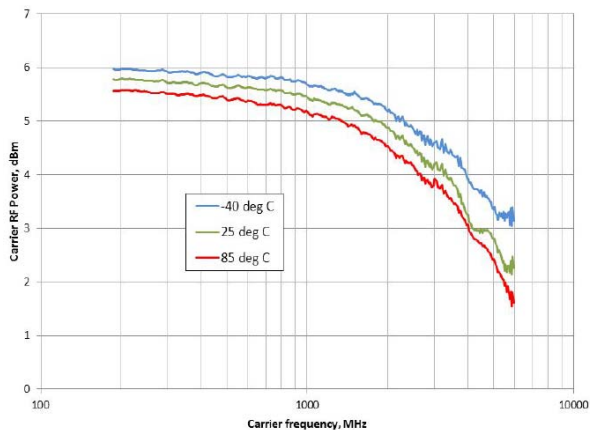

Figure 18. Output power level - single ended (3 dB more for differential)

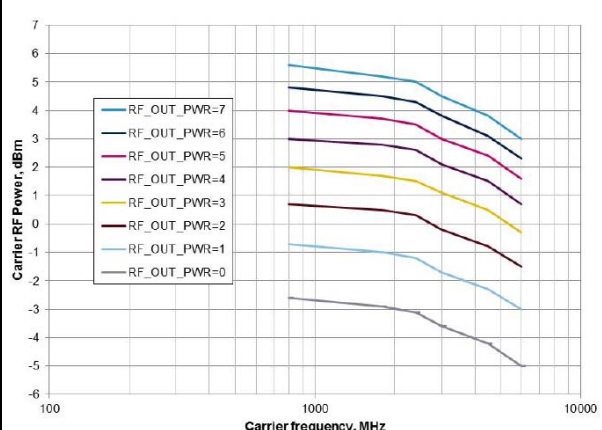

Figure 19. Typical spur level at PFD offset over carrier frequency (5.0 V supply)

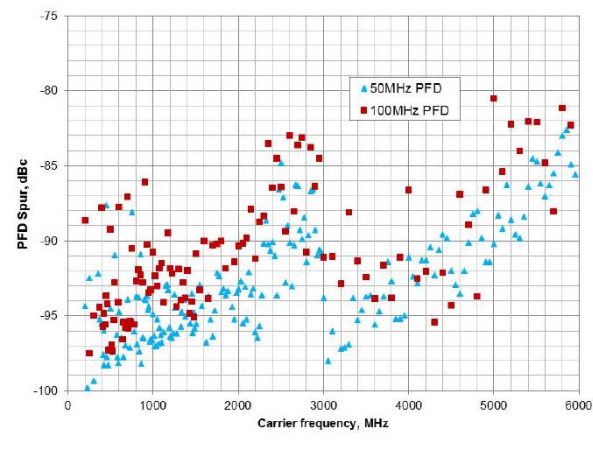

Figure 20. Typical spur level vs. offset from 4.5 GHz (5.0 V supply, $F_{PFD}=50\text{MHz}$)

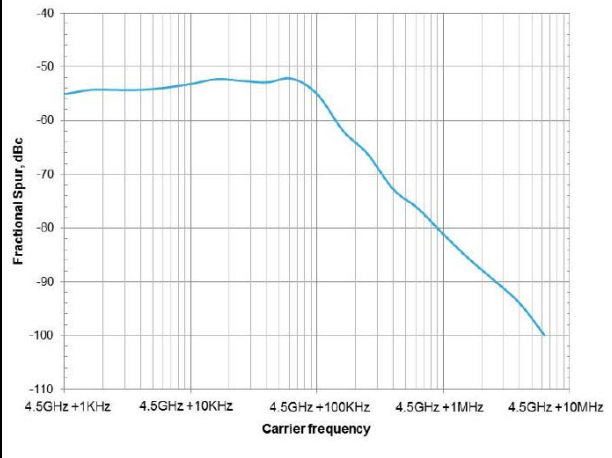

Figure 21. 10 kHz fractional spur (integer boundary) vs. temperature (5.0 V supply, $F_{PFD} = 50\text{ MHz}$)

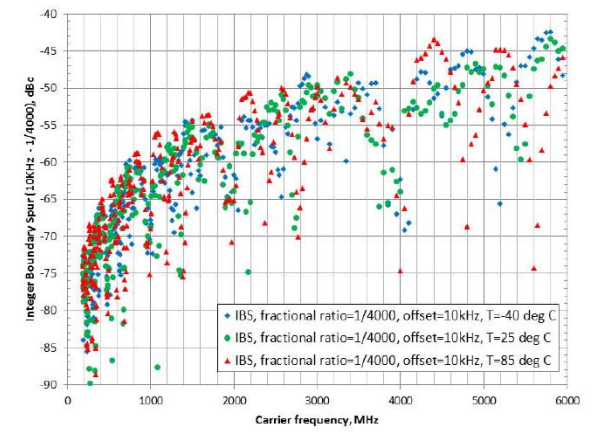

Figure 22. 800 kHz fractional spur (integer boundary) vs. temperature (5.0 V supply, $F_{PFD} = 50\text{ MHz}$)

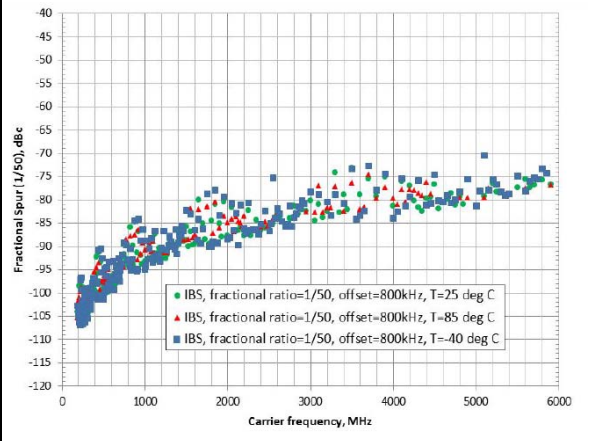

Figure 23. Frequency settling with VCO calibration – wideband view

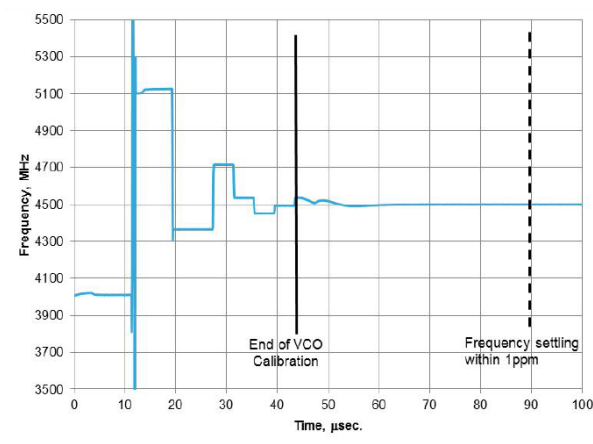

Figure 24. Frequency settling with VCO calibration – narrowband view

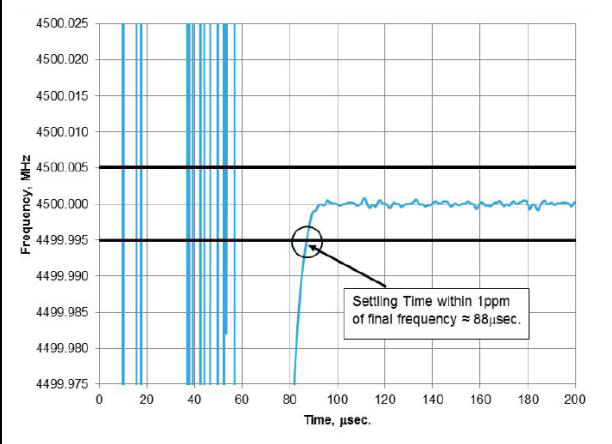

Figure 25. Overall current consumption vs. temperature (5.0 V supply, $F_{PFD} = 50$ MHz)

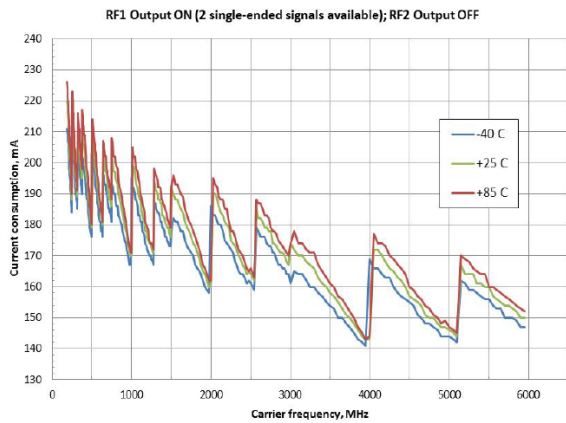

Figure 26. Current consumption – standard vs. low power (5.0 V supply, $F_{PFD} = 50$ MHz)

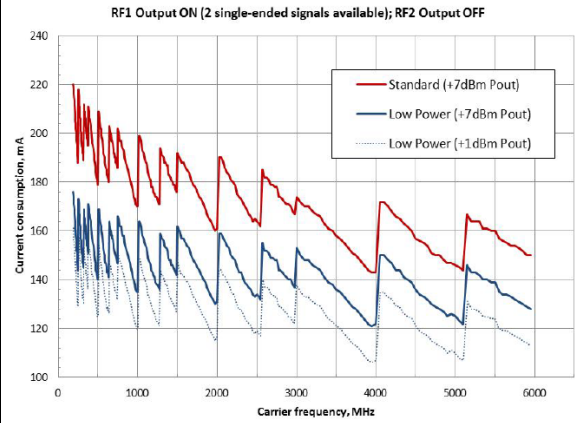

Figure 27. Current consumption – standard vs. low power (3.6 V supply, $F_{PFD} = 50$ MHz)

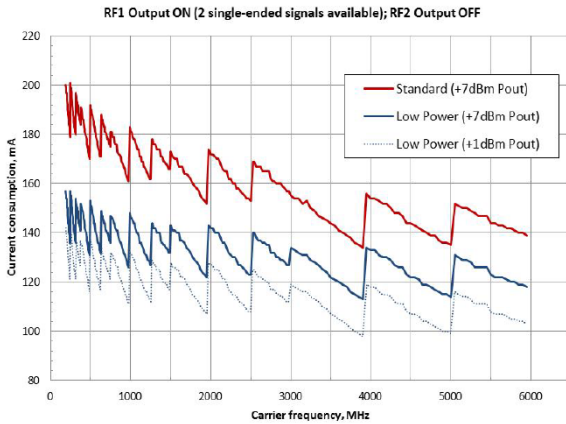
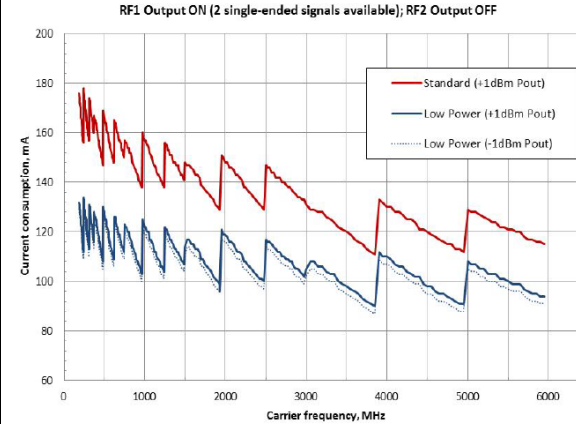

Figure 28. Current consumption – standard vs. low power (3.0 V supply, $F_{PFD} = 50$ MHz)



7 Circuit description

7.1 Reference input stage

The reference input stage provides different modes for the reference clock signal.

Both single-ended and differential modes (LVDS, LVECPL) are supported; a crystal mode is also provided in order to build a Pierce type crystal oscillator. *Figure 29* shows the connections required for the different configurations supported.

In single-ended and differential modes the inputs must be AC coupled as the REF_CLKP and REF_CLKN pins are internally biased to an optimal DC operating point. The input resistance is 100 ohms differential and the best performance for phase noise is obtained for signals with a higher slew rate, such as a square wave.

Figure 29. Reference clock buffer configurations: single-ended (A), differential (B), crystal mode (C)

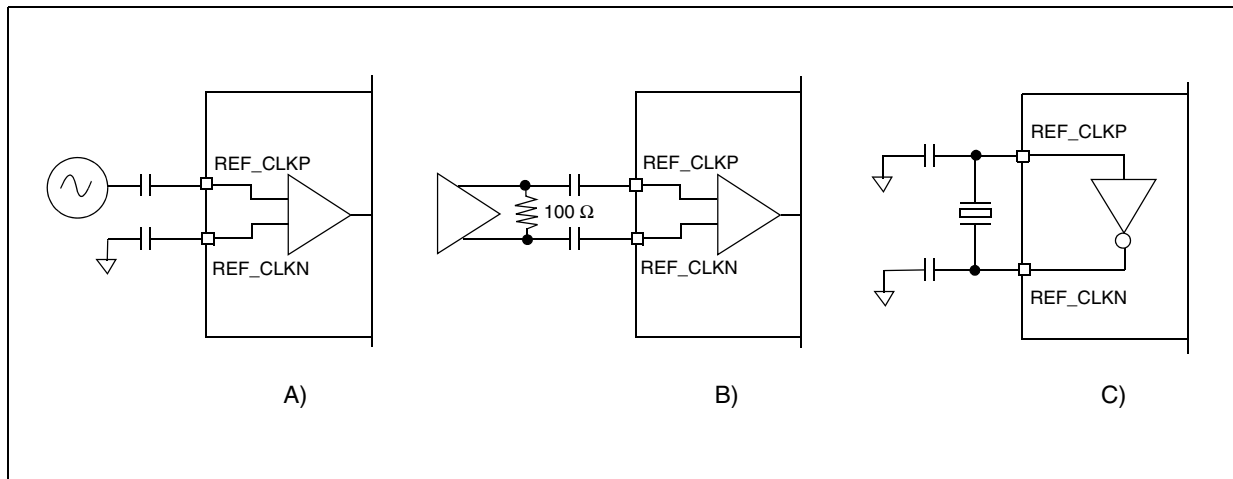

7.2 Reference divider

The 13-bit programmable reference counter is used to divide the input reference frequency to the desired PFD frequency. The division ratio is programmable from 1 to 8191.

The maximum allowed input frequency of the R-Counter is 200 MHz.

The reference clock can be extended up to 400 MHz enabling the divide-by-2 stage or up to 800 MHz enabling the divide-by-4 stage.

A frequency doubler is provided in order to double low reference frequencies and increase the PFD operating frequency thus allowing an easier filtering of the out-of-band noise of the Delta-Sigma Modulator; the doubler is introducing a noise degradation in the in-band PLL noise thus this feature should be carefully used.

When the doubler is enabled, the maximum reference frequency is limited to 25 MHz.

7.3 PLL N divider

The N divider sets the division ratio in the PLL feedback path.

Both Integer-N and Fractional-N PLL architectures are implemented in order to ensure the best overall performance of the synthesizer.

The Fractional-N division is achieved combining the integer divider section with a Delta-Sigma modulator (DSM) which sets the fractional part of the overall division ratio.

The DSM is implemented as a MASH structure with programmable order (2 bit; 1st, 2nd, 3rd and 4th order), programmable MODULUS (21 bit).

It includes also a DITHERING function (1 bit) which can be used to reduce fractional spur tones by spreading the DSM sequence and consequently the energy of the spurs over a wider bandwidth.

The overall division ratio N is given by:

$$N = N_{INT} + N_{FRAC}$$

The integer part N_{INT} is 17-bit programmable and can range from 24 to 131071 in Integer Mode. For $N_{INT} \geq 512$ the fractional mode is not allowed and the setting used for DSM does not have any effect.

Based upon the selected order of the Delta-Sigma Modulator the allowed range of N_{INT} values changes as follows:

- 24 to 510 - 1st Order DSM
- 25 to 509 - 2nd Order DSM
- 27 to 507 - 3rd Order DSM
- 31 to 503 - 4th Order DSM

The fractional part N_{FRAC} of the division ratio is controlled by setting the values FRAC and MOD (21 bits each) and it depends also on the value of DITHERING (1 bit):

$$N_{FRAC} = \frac{FRAC}{MOD} + \frac{DITHERING}{2 \cdot MOD}$$

The MOD value can range from 2 to 2097151, while the range of FRAC is from 0 to MOD-1. If the DITHERING function is not used (DITHERING=0) the fractional part of N is simply achieved as ratio of FRAC over MOD.

The resulting VCO frequency is:

$$F_{VCO} = \frac{F_{ref}}{R} \cdot N = \frac{F_{ref}}{R} \cdot \left(N_{INT} + \frac{FRAC}{MOD} + \frac{DITHERING}{2 \cdot MOD} \right)$$

where:

F_{VCO} is the output frequency of VCO

F_{ref} is the input reference frequency

R is the division ratio of reference chain

N is the overall division ratio of the PLL

The implementation with programmable modulus allows the user to select easily the desired fraction and the exact synthesized frequency without any approximation.

The MOD value can be set to very high values thus the frequency resolution of the synthesizer can reach very fine steps (down to a few hertz).

A 'low spur mode' could be configured by maximizing both FRAC and MOD values, keeping the same desired FRAC/MOD ratio, and setting the DITHERING bit to '1'. The drawback is a small frequency error, equal to $F_{PFD}/(2 \cdot MOD)$, on the synthesized frequency which is in the range of a few hertz, usually tolerated by most applications.

7.3.1 Fractional spurs and compensation mechanism

The fractional PLL operation generates unwanted fractional spurs around the synthesized frequency.

The integer boundary spurs occur when the carrier frequency is close to an integer multiple of the PFD frequency. If the frequency difference between the carrier and the $N \cdot F_{PFD}$ falls inside the PLL loop bandwidth, the integer boundary spur is unfiltered and represents the worst case situation giving the highest spur level.

The channel spurs are generated by the delta-sigma modulator operations and depend on its settings (they are mainly related to the MOD value). The channel spurs appear at a frequency offset from the carrier, equal to F_{PFD}/MOD and its harmonics, and they are not integer boundary. If the MOD value is extremely high (close to the maximum value of $2^{21}-1$) the channel spur offset is of the order of a tenth of a Hertz and it appears as 'granular noise' shaped by the PLL around the carrier.

The STW81200 provides the user with three different mechanisms to compensate fractional spurs: PFD delay mode, charge pump leakage current and down-split current. These features should be adopted case-by-case as they give different results spur-level results depending on setup conditions (reference clock frequency, PFD frequency, DSM setup, VCO frequency, carrier frequency, charge pump current, VCO/charge pump supply voltage).

PFD delay mode

The STW81200 implements two programmable differentiated delay lines in the reset path of the main flip-flop of the PFD. This allow different delay reset values to be set for VCO divided path and reference-clock divided path, allowing an offset value to be forced on the PFD and charge-pump characteristics, far enough from the zero in order to guarantee that the whole circuit works in a more linear region.

It is possible to set the sign of the delay through the PFD_DEL_MODE bit in the [ST3 Register](#) (no delay, VCO_DIV_delayed or REF_DIV_delayed). The delay value can be set through the PFD_DEL bit in the [ST0 Register](#) (2 bit; 0=1.2 ns, 1=1.9 ns, 2=2.5 ns, 3=3.0 ns). Even though the for spur-compensation settings are best optimized case-by-case, the setup 'VCO_DIV_delayed + 1.2 ns delay' is strongly recommended for most conditions.

Charge pump leakage current

A different way to force an offset value on the PFD+CP characteristics is provided within the STW81200 by sourcing or sinking a DC leakage current from the charge pump (settings available in the [ST3 Register](#)). The leakage current is 5-bit programmable starting from a base DC current of 10 μ A (it can be doubled to 20 uA by setting bit CP_LEAK_x2 = 1b). The sign is set by CP_LEAK_DIR bit: 0b = down-leakage (sink), 1b = up-leakage (source).

The resulting delay offset can be calculated as follows:

$$\text{delay} = \frac{I_{\text{LEAK}}}{F_{\text{PFD}} \cdot I_{\text{CP}}}$$

Experimental results show that down-leakage currents are more effective than up-leakage. The user must be aware that the use of the leakage current mechanism might impact the overall phase noise performance by increasing the charge pump noise contribution.

Down-split current

This mechanism is enabled through the DNSPLIT_EN bit ([ST3 Register](#)), is the injection of a down-split current pulse from the charge pump circuit. The current pulse is 16 VCO cycles wide while the current level is set by the PFD_DEL bit ([ST0 Register](#)) among 4 different possible values: 0, 0.25*ICP, 0.5*ICP or 0.75*ICP.

7.4 Phase frequency detector (PFD)

The PFD takes inputs from the reference and the VCO dividers and produces an output proportional to the phase error. The PFD includes a delay gate that controls the width of the anti-backlash pulse (1.2 to 3 ns). This pulse ensures that there is no dead zone in the PFD transfer function.

[Figure 30](#) shows a simplified schematic of the PFD.

Figure 30. PFD diagram

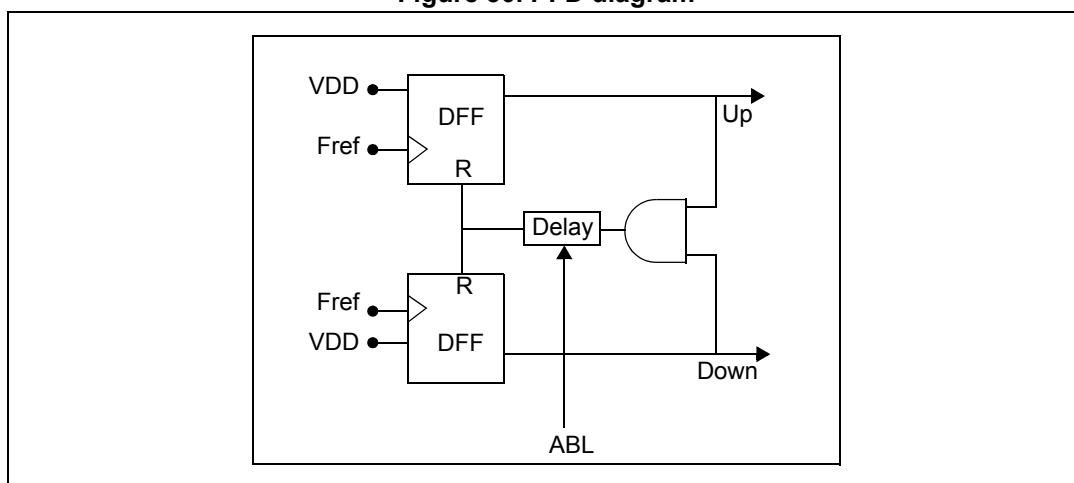

7.5 Lock detect

The lock detector indicates the lock state for the PLL. The lock condition is detected by comparing the UP and DOWN outputs of the digital Phase Frequency Detector

A CMOS logic output signal indicates the lock state; the polarity of the output signal can be inverted using the LD_ACTIVELOW bit.

The lock condition occurs when the delay between the edges of UP and DOWN signals is lower than a specific value (3-bit programmable from 2 ns to 16 ns) and this condition is stable for a specific number of consecutive PFD cycles (3-bit programmable counter from 4 to 4096 cycles).

This flexibility is needed by the lock detector circuitry to work properly with all the possible different PLL setups (Integer-N, Fractional-N, different PFD frequencies and so on).

7.6 Charge pump

This block drives two matched current sources, I_{up} and I_{down} , which are controlled respectively by the UP and DOWN PFD outputs. The nominal value of the output current (I_{CP}) can be set by a 5-bit word.

The minimum value of the output current (I_{CP}) is 158 μ A.

The charge pump also includes a compensation circuit to take into account the K_{VCO} variation versus VCO control voltage, which changes with temperature and process for a specified frequency. The K_{VCO} compensation block adjusts the nominal I_{CP} value, minimizing the variation of the product $I_{CP} \times K_{VCO}$ to keep the PLL bandwidth constant for the specified frequency.

In order to compensate the change of K_{VCO} over frequency, the user should manually adjust the I_{CP} value to keep the PLL bandwidth constant.

In addition, the charge-pump output stage can operate with a 2.5 V to 5.0 V supply voltage. The LDO_4V5 regulator, programmable at 2.6 V, 3.3 V and 4.5 V, can be used for this purpose. The CP_SUPPLY_MODE[1:0] field ([ST4 Register](#)) must be set according to the supply voltage.

Table 8. Current value vs. selection

CPSEL4	CPSEL3	CPSEL2	CPSEL1	CPSEL0	Current	Value
0	0	0	0	0	-	0
0	0	0	0	1	I_{MIN}	158 μ A
0	0	0	1	0	$2 \cdot I_{MIN}$	316 μ A
-	-	-	-	-	-	-
-	-	-	-	-	-	-
1	1	1	0	1	$29 \cdot I_{MIN}$	4.58 mA
1	1	1	1	0	$30 \cdot I_{MIN}$	4.74 mA
1	1	1	1	1	$31 \cdot I_{MIN}$	4.9 mA

7.7 Fast lock mode

The fast-lock feature can be enabled to trade fast settling time with spurs rejection, performances which generally require different settings of PLL bandwidth (narrow for better spurs rejection and wide for fast settling time).

A narrow bandwidth for lower spurs can be designed for the lock state while a wider bandwidth can be designed for the PLL transients.

The wider bandwidth is achieved during the transient by increasing the charge pump current and reducing accordingly the dumping resistor value of the loop filter in order to keep the phase margin of the PLL constant. The duration of the PLL wide band mode, in terms of number of PFD cycles, is set by programming the fast lock 13 bit counter.

7.8 Cycle slip reduction

The use of high F_{PFD}/PLL_BW ratios may lead to an increased settling time due to cycle slips.

A cycle slip compensation circuit is provided which automatically increases the charge pump current for high frequency errors and restores the programmed value at the end of the locking phase.

7.9 Voltage controlled oscillators (VCOs)

The STW81200 VCO section consists of three separate low-noise VCOs with different LC Tanks structures to cover a wide band from 3000 MHz to 6000 MHz.

Each VCO is implemented using a structure with multiple sub-bands to keep low the VCO sensitivity (K_{vco}), thus resulting in low phase noise and spurs performances.

The correct VCO and sub-band selection is automatically performed by dedicated digital circuitry (clocked by the PFD) at every new frequency programming. The VCO calibration starts when the [ST0 Register](#) is written.

During the selection procedure the VCTRL of the VCO is charged to a fixed reference voltage. A stable reference clock signal to the device must be present before the VCO calibration begins. The procedure for the VCO and sub-band selection takes approximately 11 CALB_{CLK} cycles.

The calibrator clock frequency is linked to the PFD frequency ($CALB_{CLK} = F_{PFD}/CALDIV$) and should be adjusted in order to achieve correct operation. The maximum allowed frequency is 250 kHz, therefore the calibrator divider ratio (CALDIV, [ST6 Register](#)) must be set accordingly.

When the PLL is configured in Integer mode only ($NINT \geq 512$, see [Section 7.3: PLL N divider](#)) the calibrator divider should be bypassed (CALDIV = 1). In such a case, if the setup of the application requires a PFD frequency higher than 250 kHz the calibration procedure must be executed in two steps:

1. **VCO calibration.** Configure all the device registers (see [Section 7.17: Example of register programming](#)) making sure to program the desired VCO frequency with proper settings of the values N ([ST0 Register](#)) and R ([ST3 Register](#)) so that F_{PFD} is ≤ 250 kHz
2. **Final operating setup.** Adjust the values N and R properly in order to program the device with the desired setup configuration (VCO and PFD frequency), and also set the VCO_CALB_DISABLE bit to '1' ([ST0 Register](#)).

Once the correct VCO and sub-band are selected the normal PLL operations are resumed.

The VCO core can be supplied from 2.5 to 5 V. The LDO_4V5 regulator (programmable to 4.5 V, 3.3 V and 2.6 V) is used for this purpose. Furthermore, the amplitude of oscillation, which trades current consumption for phase noise performance, is 4-bit programmable ([ST4 Register](#), VCO_AMP bit). [Section 7.15: STW81200 register descriptions](#) shows the allowed ranges of oscillation amplitude for each available supply setting. In order to achieve the best phase noise performance, the maximum amplitude setting is recommended.

7.10 RF output divider stage

The signal coming from the VCOs is fed to a flexible RF divider stage.

The divider ratio is programmable among different values (1, 2, 4, 8, 16, 32 and 64) and allows the selection of the desired output frequency band:

- 3.0 to 6.0 GHz (divider ratio = 1)
- 1.5 to 3.0 GHz (divider ratio = 2)
- 0.75 to 1.5 GHz (divider ratio = 4)
- 375 to 750 MHz (divider ratio = 8)
- 187.5 to 375 MHz (divider ratio = 16)
- 93.75 to 187.5 MHz (divider ratio = 32)
- 46.875 to 93.75 MHz (divider ratio = 64)

The final output stage buffer (pins RF1_OUTP, RF1_OUTN) is internally broadband matched to 100-ohm differential (50-ohm single-ended) and it delivers up to +7 dBm of output power on a 100-ohm differential load (+4 dBm on 50-ohm from each single-ended output).

The final output stage buffer has a 3-bit programmable output level and can be powered down by software and/or hardware (pin PD_RF1) while the internal PLL is locked. The related circuitry, together with VCO and charge pump, is compatible with supply voltages

ranging from 2.5 V to 5 V. The regulator LDO_4V5, which supplies this block, can be set to 4.5 V, 3.3 V or 2.6 V. When supplied at 2.6 V, only the lowest 2 power levels are allowed (see [ST4 Register](#) settings, RF_OUT_PWR bit)

An auxiliary output stage buffer (pins RF2_OUTP and RF2_OUTN) is available with the same features of the main one.

The RF division ratio of this auxiliary output can be set independently from the main output in order to increase the flexibility. Furthermore it is possible to get, on the auxiliary output, a signal in phase or in quadrature with the main one, if the same frequency is selected on both outputs.

The auxiliary output stage can also be powered down by software and/or hardware (pin PD_RF2).

The output stage can be muted until the PLL achieves the lock status; this function can be activated by software.

7.11 Low-power functional modes

All the performance characteristics defined in the electrical specifications are achieved in full current mode. The STW81200 is able to provide a set of low power functional modes which allows control of the current consumption of the different blocks.

This feature can be helpful for those applications requiring low power consumption. The power saving modes trade the current consumption with the phase noise performance, and/or output level.

The current of the blocks defined in [Table 9](#) can be set by software, and the power saved on each block affect a specific performance as described in the same table.

Table 9. Blocks with programmable current and related performance

Block	Current Control bits	Affected Performance
VCO Core	ST4 Register bits[18:15]	VCO phase noise (offset >PLL_BW)
VCO Buffers and mux	ST5 Register bits[12:11]	Phase Noise Floor (offset > ~10 MHz)
RF Dividers Core	ST5 Register bits [10:4]	Phase Noise Floor (offset > ~10 MHz)
RF output stage	ST4 Register bits [25:23]	RF output level

7.12 LDO voltage regulators

Low drop-out (LDO) voltage regulators are integrated to provide the synthesizer with stable supply voltages against input voltage, load and temperature variations. Five regulators are included to ensure proper isolation among circuit blocks. These regulators are listed below along with the target specifications for the regulated output voltage and current capability:

- LDO_DIG (to supply the digital circuitry),
Vreg = 2.6 V, I_{max} = 50 mA, Vin Range: 3.0 to 5.4 V
- LDO_REF (to supply the PLL),
Vreg = 2.6 V, I_{max} = 50 mA, Vin Range: 3.0 to 5.4 V
- LDO_RF (to supply the rf blocks),
Vreg = 2.6 V, I_{max} = 100 mA, Vin Range: 3.0 to 5.4 V
- LDO_VCO (to supply the low-voltage VCO sub-blocks):
Vreg = 2.6 V, I_{max} = 100 mA, Vin Range: 3.0 to 5.4 V
- LDO_4V5 (to supply high-voltage sub-blocks):
Vreg = 4.5 V, 3.3 V and 2.6 V programmable, I_{max} = 150 mA
Vin Range: 3.0 to 5.4 V (when Vreg=2.6 V)
Vin Range: 3.6 to 5.4 V (when Vreg=3.3 V)
Vin Range: 5.0 to 5.4 V (when Vreg=4.5 V)

Proper stability and frequency response are achieved by adopting 10 μ F load capacitors at the regulated output pins. The optimal configuration is achieved by connecting a small resistor in series with the capacitor in order to guarantee the controlled ESR required to ensure the proper phase margin, together with the best performance in terms of noise and PSRR. For a complete view of required connections and component values associated with the LDO output pins, see the related PCB schematics section available from the STW81200 product page on the ST website.

Very-low noise requirements have been assumed for the design of the VCO-related regulators (LDO_VCO and LDO_4V5). To comply with the noise specifications, these LDOs exploit an additional external bypass (feed forward) capacitor of 100 nF.

All LDOs include over-current protection to avoid short-circuit failures, as well as internal power ramping to minimize startup current peaks.

All LDOs operate from a reference voltage of 1.35 V, which is internally generated by an integrated band-gap circuit and noise-filtered through an external 10 μ F capacitor.

7.13 STW81200 register programming

The STW81200 has 12 registers (10 R/W + 2 Read-Only) programmed through an SPI digital interface. The protocol uses 3 wires (SDI, SCK, LE) for write mode plus an additional pin (LD_SDO) for read operation. Each register has 32 bits, one for Read/Write mode selection, 4 address bits and 27 data bits.

Figure 31. SPI Protocol

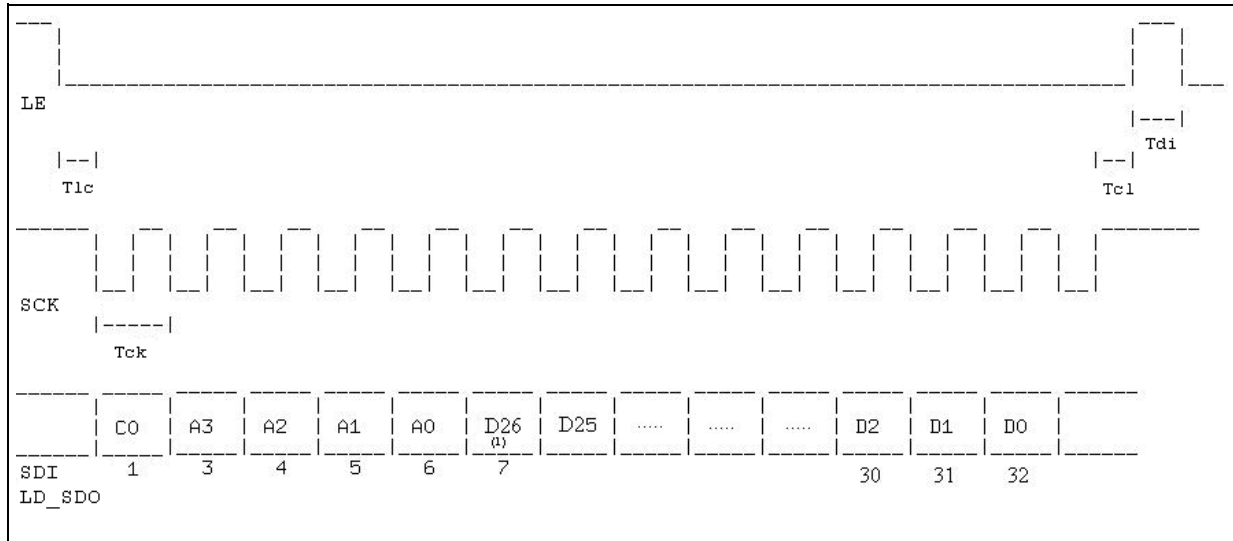

1. Bit for double buffering used for some registers only

The Data bits are stored in the internal shift register on the rising edge of SCK.

The first bit, CO is used for mode selection (0=Write Operation, 1=Read Operation). The bit A[3:0] represents the register address, and D[26:0] are the data bits.

In some registers, the first data bit D26 is used (when set to '1') for double-buffering purposes. In this case the register content is stored in a temporary buffer and is transferred to the internal register once a write operation is done on the master register ST0.

Figure 32. SPI timing diagram

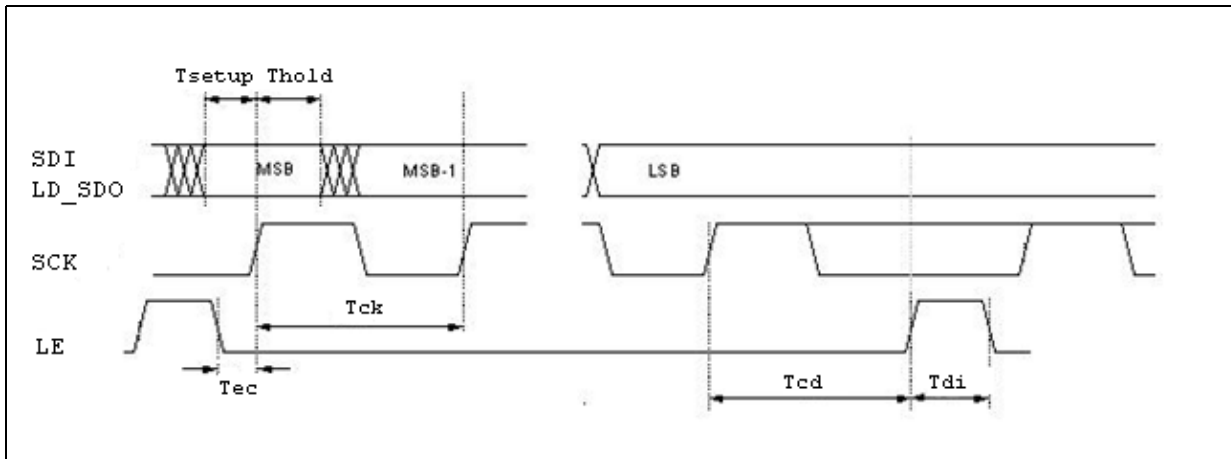

Table 10. SPI timings

Parameter	Comments	Min	Typ	Max	Unit
Tsetup	data to clock setup time	4	-	-	ns
Thold	data to clock hold time	1	-	-	ns
Tck	clock cycle period	20	-	-	ns
Tdi	disable pulse width	4	-	-	ns
Tcd	clock-to-disable time	1	-	-	ns
Tec	enable-to-clock time	3	-	-	ns

7.14 STW81200 register summary

Table 11. SPI Register map (address 12 to 15 not available)

Address	Register Name	Type	Description	Page
0x00	ST0_Register	Read/Write	Master register. N divider, CP current. Writing to this register starts a VCO calibration	on page 36
0x01	ST1_Register	Read/Write Double-Buffered	FRAC value, RF1 output control	on page 37
0x02	ST2_Register	Read/Write Double-Buffered	MOD value, RF2 output control	on page 38
0x03	ST3_Register	Read/Write Double-Buffered	R divider, CP leakage, CP down-split pulse, Ref. Path selection, Device power down	on page 39
0x04	ST4_Register	Read/Write	Lock det. control, Ref. Buffer, CP supply mode, VCO settings, Output power control	on page 41
0x05	ST5_Register	Read/Write	Low power mode control bit	on page 43
0x06	ST6_Register	Read/Write	VCO Calibrator, Manual VCO control, DSM settings	on page 44
0x07	ST7_Register	Read/Write	Fast Lock control, LD_SDO settings	on page 46
0x08	ST8_Register	Read/Write	LDO Voltage Regulator settings	on page 47
0x09	ST9_Register	Read/Write	Reserved (Test & Initialization bit)	on page 48
0x0A	ST10_Register	Read Only	VCO, Lock det. Status, LDO status	on page 49
0x0B	ST11_Register	Read Only	Device ID	on page 50

7.15 STW81200 register descriptions

ST0 Register

	26	25	24	23	22	21	20	19	18	17	16	15	14	13	12	11	10	9	8	7	6	5	4	3	2	1	0
VCO_CALB_DISABLE	CP_SEL[4:0]				PFD_DEL[1:0]		RESERVED	RESERVED	N[16:0]																		
RW	RW				RW		RW	RW	RW																		

Address: STW81200BaseAddress + 0x00

Type: R/W

Description: Master register. N divider, CP current

- [26] VCO_CALB_DISABLE: must be set to '0'. Setting this bit to '1' disables the VCO calibrator. (Note: this bit is write-only and cannot be read. A read operation always returns a '1')
- [25:21] CP_SEL: Set charge pump pulse current value (0 to 4.9 mA; step ~158 μ A)
 - 00000: (0) set ICP=0
 - 00001: (1) set ICP=158 μ A
 - 00010: (2) set ICP=316 μ A
 - ...
 - 11110: (30) set ICP=4.74 mA
 - 11111: (31) set ICP=4.90 mA
- [20:19] PFD_DEL: Set PFD anti-backlash delay / down-split current value
 - 00: (0) 1.2 ns / 0 A (default)
 - 01: (1) 1.9 ns / 0.25*I_{CP}
 - 10: (2) 2.5 ns / 0.5*I_{CP}
 - 11: (3) 3.0 ns / 0.75*I_{CP}
- [18] RESERVED: must be set to '0'
- [17] RESERVED: must be set to '0'
- [16:0] N: Set integer part of N divider ratio (N_{INT})
 - For N_{INT} \geq 512, fractional mode is not allowed (FRAC and MOD settings are ignored)

ST1 Register

26	25	24	23	22	21	20	19	18	17	16	15	14	13	12	11	10	9	8	7	6	5	4	3	2	1	0
DBR	RESERVED	RF1_OUT_PD	RF1_DIV_SEL[2:0]																						FRAC[20:0]	
RW	RW	RW	RW																						RW	

Address: STW81200BaseAddress + 0x01

Type: R/W

Applicability: Double buffered (based upon DBR bit setting)

Description: FRAC value, RF1 output control

- [26] DBR: Double buffering bit enable; at '1' the register is buffered and transferred only once the master register ST0 is written
- [25] RESERVED: must be set to '0'
- [24] RF1_OUT_PD: RF1 output power down
0 = RF1 output enabled
1 = RF1 output disabled
- [23:21] RF1_DIV_SEL: RF1 output divider selection
000: (0) VCO direct
001: (1) VCO divided by 2
010: (2) VCO divided by 4
011: (3) VCO divided by 8
100: (4) VCO divided by 16
101: (5) VCO divided by 32
110: (6) VCO divided by 64
111: (7) Reserved
- [20:0] FRAC: Fractional value bit; set the numerator value of the fractional part of the overall division ratio ($N=N_{INT}+FRAC/MOD$)
Range: 0 to 2097151 (must be < MOD)

ST2 Register

26	25	24	23	22	21	20	19	18	17	16	15	14	13	12	11	10	9	8	7	6	5	4	3	2	1	0
DBR	RESERVED	RF2_OUT_PD	RF2_DIV_SEL[2:0]	MOD[20:0]																						
RW	RW	RW	RW	RW																						

Address: STW81200BaseAddress + 0x02

Type: R/W

Applicability: Double buffered (based upon DBR bit setting)

Description: MOD value, RF2 output control

- [26] DBR: Double buffering bit enable; at '1' the register is buffered and transferred only once the master register ST0 is written
- [25] RESERVED: must be set to '0'
- [24] RF2_OUT_PD: RF2 output power down
0 = RF2 output enabled
1 = RF2 output disabled
- [23:21] RF2_DIV_SEL: RF2 output divider selection
000: (0) VCO direct
001: (1) VCO divided by 2
010: (2) VCO divided by 4
011: (3) VCO divided by 8
100: (4) VCO divided by 16
101: (5) VCO divided by 32
110: (6) VCO divided by 64
111: (7) same divided output of RF1 (not valid if RF1_DIV_SEL=0)
- [20:0] MOD: Modulus value bit; set the denominator value of the fractional part of the overall division ratio ($N=N_{INT}+FRAC/MOD$)
Range: 2 to 2097151

ST3 Register

26	25	24	23	22	21	20	19	18	17	16	15	14	13	12	11	10	9	8	7	6	5	4	3	2	1	0
DBR		PD	CP_LEAK_x2	CP_LEAK[4:0]				CP_LEAK_DIR	DNSPLIT_EN	PFD_DEL_MODE[1:0]		REF_PATH_SEL[1:0]		R[12:0]												
RW		RW	RW	RW				RW	RW	RW		RW		RW												

Address: STW81200BaseAddress + 0x03

Type: R/W

Applicability: Double buffered (based upon DBR bit setting)

Description: R divider, CP leakage, CP down-split pulse, Ref. Path selection, Device power down

[26] DBR: Double buffering bit enable; at '1' the register is buffered and transferred only once the master register ST0 is written

[25] PD: device power down; at '1' put OFF all blocks (except LDOs)

[24] CP_LEAK_x2: double Charge Pump leakage current bit
 0 = set standard leakage current (10 μ A step)
 1 = set doubled leakage current (20 μ A step)

[23:19] CP_LEAK: Set Charge Pump leakage current value (0 to 620 μ A; step 10 μ A or 20 μ A base upon CP_LEAK_x2 setting)

- 00000: (0) set $I_{LEAK} = 0$ (default)
- 00001: (1) set $I_{LEAK} = 10 \mu$ A ($I_{LEAK} = 20 \mu$ A if CP_LEAK_x2 = 1)
- 00010: (2) set $I_{LEAK} = 20 \mu$ A ($I_{LEAK} = 40 \mu$ A if CP_LEAK_x2 = 1)
- ...
- 11110: (30) set $I_{LEAK} = 300 \mu$ A ($I_{LEAK} = 600 \mu$ A if CP_LEAK_x2 = 1)
- 11111: (31) set $I_{LEAK} = 310 \mu$ A ($I_{LEAK} = 620 \mu$ A if CP_LEAK_x2 = 1)

[18] CP_LEAK_DIR: set direction of the leakage current
 0: set down-leakage (current sink)
 1: set up-leakage (current source)

[17] DNSPLIT_EN: at '1' enables down-split pulse current; current level set by PFD_DEL[1:0] in register ST0

- [16:15] PFD_DEL_MODE: set PFD delay mode; delay values set by PFD_DEL[1:0] in register ST0
- 00: (0) no delay (default)
 - 01: (1) VCO_DIV delayed
 - 10: (2) REF_DIV delayed
 - 11: (3) Reserved
- [14:13] REF_PATH_SEL: reference clock path selection
- 00: (0) Direct
 - 01: (1) Doubled in single mode; Not Applicable in differential mode
 - 10: (2) Divided by 2
 - 11: (3) Divided by 4
- [12:0] R: set Reference clock divider ratio (1 to 8191)

- [14] PLL_MUX_DIV: PLL MUX setting; select the desired signal path from VCO to the N Divider (VCO divider in the PLL feedback path):
0: VCO direct to N Divider (default)
1: VCO divided to N Divider (division ratio set by RF1_DIV_SEL in register ST1)
- [13:12] CP_SUPPLY_MODE: Charge Pump supply mode settings; value to be set according to the supply used for charge pump core circuit (pin #16)
00: (0) 4.5V to 5.0 V
01: (1) 3.3 V
10: (2) 2.6 V
11: (3) Reserved
- [11] KVCO_COMP_DIS: disable KVCO compensation circuit
0: compensation enabled (default - CP current auto-adjusted to compensate K_{VCO} variation)
1: compensation disabled (CP current fixed by CP_SEL settings)
- [10] PFD_POL: set PFD polarity
0: standard mode (default)
1: "inverted" mode (to be used only with active inverting loop filter or with VCO with negative tuning characteristics)
- [9:8] REF_BUFF_MODE: set Reference Clock buffer mode
00: (0) Reserved
01: (1) Differential Mode (Ref. clock signal on pin #20 and #21)
10: (2) XTAL Mode (Xtal oscillator enabled with crystal connected on pin #20 and #21)
11: (3) Single Ended Mode (Ref. clock signal on pin #21)
- [7] MUTE_LOCK_EN: enables mute function
0: "mute on unlock" function disabled
1: "mute on unlock" function enabled (RF output stages are put OFF when PLL is unlocked)
- [6] LD_ACTIVELOW: set low state as lock indicator
0: set lock indicator active high (LD=0 means PLL unlocked; LD=1 means PLL locked)
1: set lock indicator active low (LD=0 means PLL locked; LD=1 means PLL unlocked)
- [5:3] LD_PREC: set Lock Detector precision
000: (0) 2 ns (default for Integer Mode)
001: (1) 4 ns (default for Fractional Mode)
010: (2) 6 ns
011: (3) 8 ns
100: (4) 10 ns
101: (5) 12 ns
110: (6) 14 ns
111: (7) 16 ns
- [2:0] LD_COUNT: set Lock Detector counter for lock condition
000: (0) 4
001: (1) 8 (default for $F_{PFD} \sim 1$ MHz in Integer Mode)
010: (2) 16
011: (3) 64
100: (4) 256
101: (5) 1024 (default for $F_{PFD} \sim 50$ MHz in both Fractional/Integer Mode)
110: (6) 2048
111: (7) 4096

ST5 Register

26	25	24	23	22	21	20	19	18	17	16	15	14	13	12	11	10	9	8	7	6	5	4	3	2	1	0	
RESERVED	RESERVED	RESERVED												VCO_BUFF_LP	VCO_MUX_LP	RF_DIV2_LP	RF_DIV4_LP	RF_DIV8_LP	RF_DIV16_LP	RF_DIV32_LP	RF_DIV64_LP	RF_DIV_MUXOUT_LP	RESERVED	PLL_MUX_LP	RESERVED	REF_BUFF_LP	
RW	RW	RW												RW	RW	RW	RW	RW	RW	RW	RW	RW	RW	RW	RW	RW	RW

Address: STW81200BaseAddress + 0x05

Type: R/W

Description: Low power mode control bit

[26] RESERVED: must be set to '0'

[25] RESERVED: must be set to '0'

[24:13] RESERVED: must be set to '0'

[12] VCO_BUFF_LP: VCO Buffer low power mode (0=full power; 1=low power)

[11] VCO_MUX_LP: VCO MUX low power mode (0=full power; 1=low power)

[10] RF_DIV2_LP: RF Div. by 2 low power mode (0=full power; 1=low power)

[9] RF_DIV4_LP: RF Div. by 4 low power mode (0=full power; 1=low power)

[8] RF_DIV8_LP: RF Div. by 8 low power mode (0=full power; 1=low power)

[7] RF_DIV16_LP: RF Div. by 16 low power mode (0=full power; 1=low power)

[6] RF_DIV32_LP: RF Div. by 32 low power mode (0=full power; 1=low power)

[5] RF_DIV64_LP: RF Div. by 64 low power mode (0=full power; 1=low power)

[4] RF_DIV_MUXOUT_LP: RF Div. MUX low power mode (0=full power; 1=low power)

[3] RESERVED: must be set to '0'

[2] PLL_MUX_LP: MUX PLL low power mode (0=full power; 1=low power)

[1] RESERVED: must be set to '0'

[0] REF_BUFF_LP: Ref. Buffer low power mode (0=full power; 1=low power)

ST6 Register

26	25	24	23	22	21	20	19	18	17	16	15	14	13	12	11	10	9	8	7	6	5	4	3	2	1	0
DITHERING	CP_UP_OFF	CP_DN_OFF	DSM_ORDER[1:0]	DSM_CLK_DISABLE	MAN_CALB_EN	VCO_SEL[1:0]	VCO_WORD[4:0]				CAL_TEMP_COMP	PRCHG_DEL[1:0]	CAL_ACC_EN	CAL_DIV[8:0]												
RW	RW	RW	RW	RW	RW	RW	RW				RW	RW	RW	RW												

Address: STW81200BaseAddress + 0x06

Type: R/W

Description: VCO Calibrator, Manual VCO control, DSM settings

- [26] DITHERING: at '1' enables dithering of DSM output sequence
- [25] CP_UP_OFF: for test purposes only; must be set to '0'
- [24] CP_DN_OFF: for test purposes only; must be set to '0'
- [23:22] DSM_ORDER: set the order of Delta-Sigma Modulator
 - 00: (0) 3rd order DSM (recommended)
 - 01: (1) 2nd order DSM
 - 10: (2) 1st order DSM
 - 11: (3) 4th order DSM
- [21] DSM_CLK_DISABLE: for test purposes only; must be set to '0'
- [20] MAN_CALB_EN: enables manual VCO calibrator mode
 - 0: automatic VCO calibration (VCO_SEL, VCO_WORD settings are ignored)
 - 1: manual VCO calibration (VCO_SEL, VCO_WORD settings are used and the VCO calibration procedure is inhibited)
- [19:18] VCO_SEL: VCO selection bit
 - 00: (0) VCO_HIGH
 - 01: (1) VCO_LOW
 - 10: (2) VCO_MID
 - 11: (3) VCO_LOW
- [17:13] VCO_WORD: select specific VCO sub-band (range:0 to 31)
- [12] CAL_TEMP_COMP: at '1' enables temperature compensation for VCO calibration procedure (to be used when PLL Lock condition is required on extremes thermal cycles)

- [11:10] PRCHG_DEL: set the number of calibration slots for pre-charge of VCTRL node at the Voltage reference value used during VCO calibration procedure
- 00: (0) 1 slot (default)
 - 01: (1) 2 slots
 - 10: (2) 3 slots
 - 11: (3) 4 slots
- [9] CAL_ACC_EN: at '1' increase calibrator accuracy by removing residual error taking 2 additional calibration slots (default = '0')
- [8:0] CAL_DIV: Set Calibrator Clock divider ratio (Range:1 to 511); '0' set the maximum ratio ('511')

ST7 Register

26	25	24	23	22	21	20	19	18	17	16	15	14	13	12	11	10	9	8	7	6	5	4	3	2	1	0
RESERVED	LD_SDO_tristate	LD_SDO_MODE	SPI_DATA_OUT_DISABLE	LD_SDO_SEL[1:0]	REGDIG_OCP_DIS	CYCLE_SLIP_EN	FSTLCK_EN	CP_SEL_FL[4:0]	FSTLCK_CNT[12:0]																	
RW	RW	RW	RW	RW	RW	RW	RW	RW	RW																	

Address: STW81200BaseAddress + 0x07

Type: R/W

Description: Fast Lock control, LD_SDO settings

- [26] RESERVED: must be set to '0'
- [25] LD_SDO_tristate: at '1' put LD_SDO out pin in Tri-State mode
- [24] LD_SDO_MODE: LD_SDO output interface mode selection
0: Open Drain mode (Level Range: 1.8V to 3.6V)
1: 2.5V CMOS output mode
- [23] SPI_DATA_OUT_DISABLE: disable auto-switch of LD_SDO pin during SPI read mode
0: LD_SDO pin automatically switched to SPI data out line during SPI read mode
1: LD_SDO pin fixed to Lock detector indication (SPI read operation not possible)
- [22:21] LD_SDO_SEL: LD_SDO Mux output selection bit
00: (0) Lock Detector (default)
01: (1) VCO Divider output (for test purposes only)
10: (2) Calibrator VCO Divider output (for test purposes only)
11: (3) Fast Lock clock output (for test purposes only)
- [20] REGDIG_OCP_DIS: for test purposes only ; must be set to '0' (at '1' disable the over-current protection of Digital LDO Voltage Regulator)
- [19] CYCLE_SLIP_EN: at '1' enables Cycle Slip feature
- [18] FSTLCK_EN: at '1' enables Fast lock mode using pin #6 (PD_RF2/FL_SW)
- [17:13] CP_SEL_FL: set the Charge Pump current during fast lock time slot (range:0 to 31)
- [12:0] FSTLCK_CNT: Fast-Lock counter value (Range: 2 to 8191); set duration of fast-lock time slot as number of F_{PFD} cycles

ST8 Register

26	25	24	23	22	21	20	19	18	17	16	15	14	13	12	11	10	9	8	7	6	5	4	3	2	1	0
PD_RF2_DISABLE	RESERVED	RESERVED	RESERVED	RESERVED	RESERVED	RESERVED	RESERVED	REG_OCP_DIS	REG_DIG_PD	REG_DIG_VOUT[1:0]	RESERVED	REG_REF_PD	REG_REF_VOUT[1:0]	RESERVED	REG_RF_PD	REG_RF_VOUT[1:0]	RESERVED	REG_VCO_PD	REG_VCO_VOUT[1:0]	RESERVED	REG_VCO_4V5_PD	REG_VCO_4V5_VOUT[1:0]				
RW	RW	RW	RW	RW	RW	RW	RW	RW	RW	RW	RW	RW	RW	RW	RW	RW	RW	RW	RW	RW	RW	RW	RW	RW	RW	RW

Address: STW81200BaseAddress + 0x08

Type: R/W

Description: LDO Voltage Regulator settings

- [26] PD_RF2_DISABLE: at '1' disable the hardware power down function of the pin PD_RF2 (pin #6) thus allowing the pin PD_RF1 (pin #5) to control the power down status of both RF Output stages
- [25] RESERVED: must be set to '0'
- [24] RESERVED: must be set to '0'
- [23] RESERVED: must be set to '0'
- [22] RESERVED: must be set to '0'
- [21] RESERVED: must be set to '0'
- [20] RESERVED: must be set to '0'
- [19] REG_OCP_DIS: for test purposes only; must be set to '0' (at '1' disable the over-current protection of LDO Voltage Regulators except DIG regulator)
- [18] REG_DIG_PD: DIGITAL Regulator power down; must be set to '0'
- [17:16] REG_DIG_VOUT: DIGITAL Regulator output voltage set
 - 00: (0) 2.6 V (Default)
 - 01: (1) 2.3 V (for test purposes only)
 - 10: (2) 2.4 V (for test purposes only)
 - 11: (3) 2.5 V (for test purposes only)
- [15] RESERVED: must be set to '0'
- [14] REG_REF_PD: REFERENCE CLOCK Regulator power down; must be set to '0'
- [13:12] REG_REF_VOUT: REFERENCE CLOCK Regulator output voltage set
 - 00: (0) 2.6 V (default)
 - 01: (1) 2.5 V (for test purposes only)
 - 10: (2) 2.7 V (for test purposes only)
 - 11: (3) 2.8 V (for test purposes only)
- [11] RESERVED: must be set to '0'
- [10] REG_RF_PD: RF Output section Regulator power down; must be set to '0'

- [9:8] REG_RF_VOUT: RF Output section Regulator output voltage set
 - 00: (0) 2.6 V (default)
 - 01: (1) 2.5 V (for test purposes only)
 - 10: (2) 2.7 V (for test purposes only)
 - 11: (3) 2.8 V (for test purposes only)
- [7] RESERVED: must be set to '0'
- [6] REG_VCO_PD: VCO bias-and-control regulator power down; must be set to '0'
- [5:4] REG_VCO_VOUT: VCO bias-and-control regulator output voltage set
 - 00: (0) 2.6 V (default)
 - 01: (1) 2.5 V (for test purposes only)
 - 10: (2) 2.7 V (for test purposes only)
 - 11: (3) 2.8 V (for test purposes only)
- [3] RESERVED: must be set to '0'
- [2] REG_VCO_4V5_PD: High-voltage regulator power down (to be used to supply VCO core, RF output final stage and Charge Pump). Must be set to '0'
- [1:0] REG_VCO_4V5_VOUT: High-voltage regulator output voltage set (to be used to supply VCO core, RF output final stage and charge-pump output)
 - 00: (0) 5.0 V (Require 5.4 V unregulated voltage line on pin# 36 for test purposes only)
 - 01: (1) 2.6 V (3.0-5.4 V unregulated voltage line Range allowed on pin#36)
 - 10: (2) 3.3 V (3.6-5.4 V unregulated voltage line Range allowed on pin#36)
 - 11: (3) 4.5 V (5.0-5.4 V unregulated voltage line Range allowed on pin#36)

ST9 Register

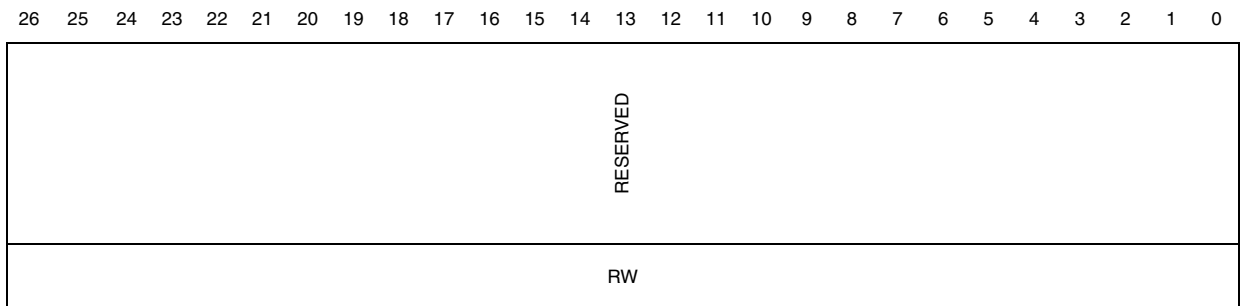

Address: STW81200BaseAddress + 0x09
Type: R/W
Description: Reserved (Test & Initialization bit)

[26:0] RESERVED: Test & Initialization bit; must be set to '0'

ST10 Register

26	25	24	23	22	21	20	19	18	17	16	15	14	13	12	11	10	9	8	7	6	5	4	3	2	1	0
RESERVED								REG_DIG_STARTUP	REG_REF_STARTUP	REG_RF_STARTUP	REG_VCO_STARTUP	REG_VCO_4V5_STARTUP	REG_DIG_OCP	REG_REF_OCP	REG_RF_OCP	REG_VCO_OCP	REG_VCO_4V5_OCP	LOCK_DET	VCO_SEL[1:0]	WORD[4:0]						
R								R	R	R	R	R	R	R	R	R	R	R	R	R	R					

Address: STW81200BaseAddress + 0x0A

Type: R

Description: VCO, Lock det. Status, LDO status

[26:18] RESERVED: fixed to '0'

- [17] REG_DIG_STARTUP: DIGITAL regulator ramp-up indicator ('1' means correct start-up)
- [16] REG_REF_STARTUP: REFERENCE CLOCK regulator ramp-up indicator ('1' means correct start-up)
- [15] REG_RF_STARTUP: RF Output section regulator ramp-up indicator ('1' means correct start-up)
- [14] REG_VCO_STARTUP: VCO bias-and-control regulator ramp-up indicator ('1' means correct start-up)
- [13] REG_VCO_4V5_STARTUP: High-voltage regulator ramp-up indicator ('1' means correct start-up)
- [12] REG_DIG_OCP: DIGITAL regulator over-current protection indicator ('1' means over-current detected)
- [11] REG_REF_OCP: REFERENCE CLOCK regulator over-current protection indicator ('1' means over-current detected)
- [10] REG_RF_OCP: RF Output section regulator over-current protection indicator ('1' means over-current detected)
- [9] REG_VCO_OCP: VCO Bias and Control regulator over-current protection indicator ('1' means over-current detected)
- [8] REG_VCO_4V5_OCP: High Voltage regulator over-current protection indicator ('1' means over-current detected)
- [7] LOCK_DET: Lock detector status bit ('1' means PLL locked)
- [6:5] VCO_SEL: VCO selected by Calibration algorithm
 - 00: (0) VCO_HIGH
 - 01: (1) VCO_LOW
 - 10: (2) VCO_MID
 - 11: (3) VCO_LOW
- [4:0] WORD: specific VCO sub-band selected by Calibration algorithm (Range:0 to 31)

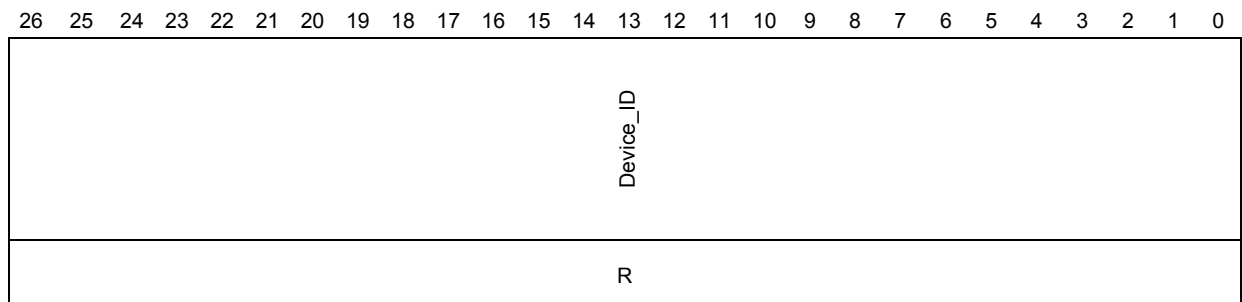
ST11 Register

Address: STW81200BaseAddress + 0x0B

Type: R

Description: Device ID

[26:0] Device_ID: Device Identifier (0x0008021)

7.16 Power ON sequence

In order to guarantee the correct start-up of the internal circuitry after the power on, the following steps must be followed:

1. Power up the device (LDO supply pins: pin#9 #18, #28 and #36)
2. Once the voltages applied on the LDO supply pins are stable, wait 50 ms. (After this transient time, the LDOs are powered on with the regulated voltages available at pins #2, #8, #19, #27 and #29, while all other circuits are in power down mode)
3. Provide the reference clock signal
4. Implement the first programming sequence as follows:
 - a) Program register ST9 (test and initialization) with all bit set to '0'
 - b) Program register ST0 according to the desired configuration
 - c) Program the following registers in the specified order according to the desired configuration: ST8, ST7, ST6, ST5, ST4, ST3, ST2, ST1, ST0
5. Check the PLL Lock status on pin LD_SDO (pin #26) and/or read all relevant information provided on registers ST10 and ST11.

7.17 Example of register programming

Setup conditions and requirements:

- Unregulated Supply voltage: 5.0 V
- Reference Clock: 122.88 MHz, single-ended, sine wave
- LO Frequency: 2646.96 MHz – exact freq. mode (VCO Frequency=5293.92 MHz)
- Output Power: +7 dBm (differential)
- Phase Noise requirements: full performance VCO, full performance Noise floor.

Register configurations (Hex values including register address)

- ST9 = 0x48000000 (initialization; all bits set to '0')
- ST8 = 0x40000003 (REG_4V5 = 4.5 V)
- ST7 = 0x39000000 ("fast lock" not used; LD_SDO pin configured as 2.5 V CMOS buffer)
- ST6 = 0x30001000 (DITHERING=0; DSM_ORDER=0 for 3rd order DSM; CAL_TEMP_COMP=1 to guarantee lock on extreme temperature drift)
- ST5 = 0x28000000 (low power modes not used)
- ST4 = 0x2387838D (lock detector setting for fractional mode and $F_{PFD} = 61.44$ MHz; REF_BUF_MODE=3 for single-ended mode; VCO_AMP=15 for best VCO phase noise @4.5 V supply; RF_OUT_PWR=7 to have +7 dBm differential)
- ST3 = 0x18008002 (PFD_DEL_MODE = 'VCO_DIV_delayed', R=2 and REF_PATH_SEL = 0 'direct' for $F_{PFD} = 61.44$ MHz)
- ST2 = 0x13000080 (MOD=128; RF2_OUT_PD=1 for RF2 Output in power down)
- ST1 = 0x08200015 (FRAC=21; RF1_DIVSEL=1 set RF1 Output with VCO freq. Divided By 2)
- ST0 = 0x03E00056 ($N_{INT}=86$; PFD_DEL = 1.2 ns; CPSEL = 31 for $I_{cp} = 4.9$ mA)

8 Application information

8.1 Application diagrams

Figure 33. Application diagram (internal VCO)

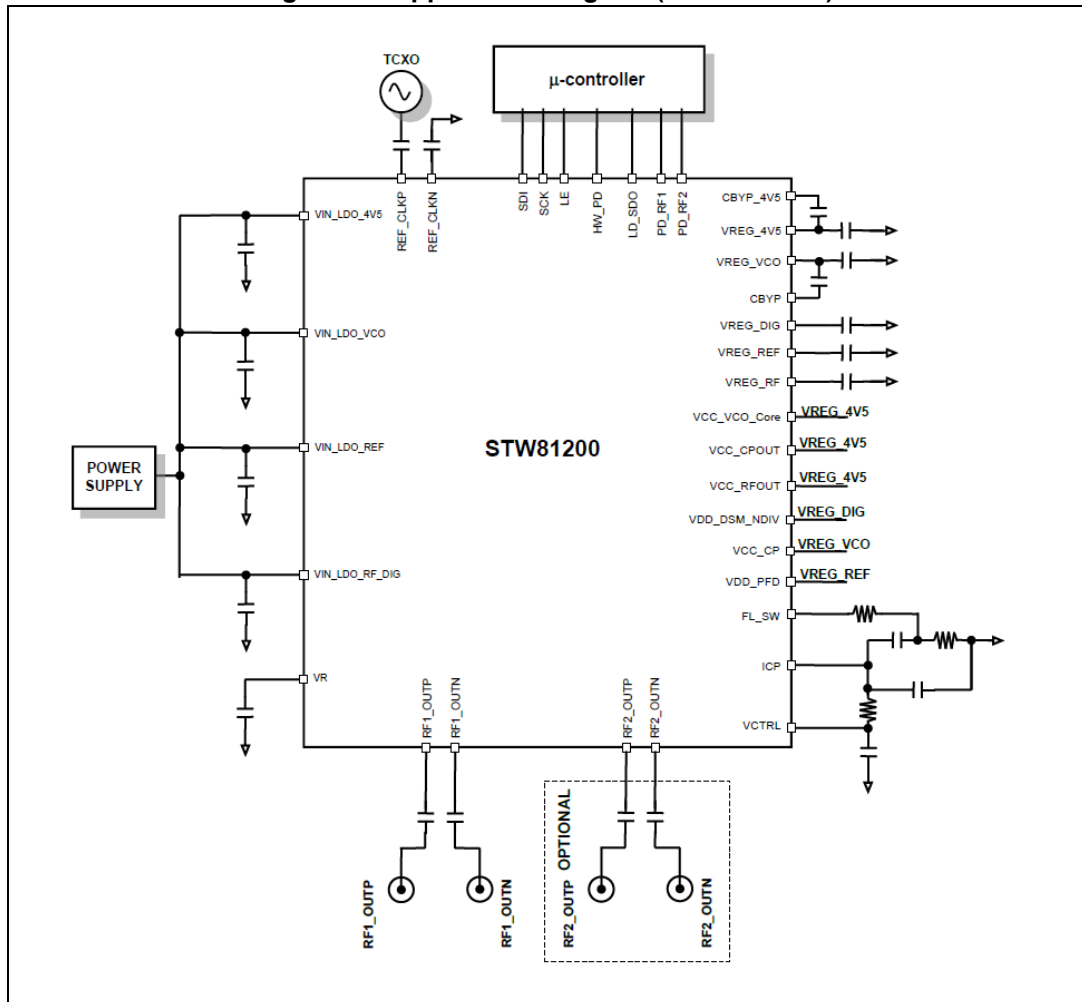

Note: This diagram shows a simplified schematic; the Evaluation Board schematic should be used as reference for connections and components values. Visit the STW81200 product page on the ST website www.st.com/stw81200ad to download the Evaluation Board Data Brief including PCB schematics.

Figure 34. Application diagram (external VCO)

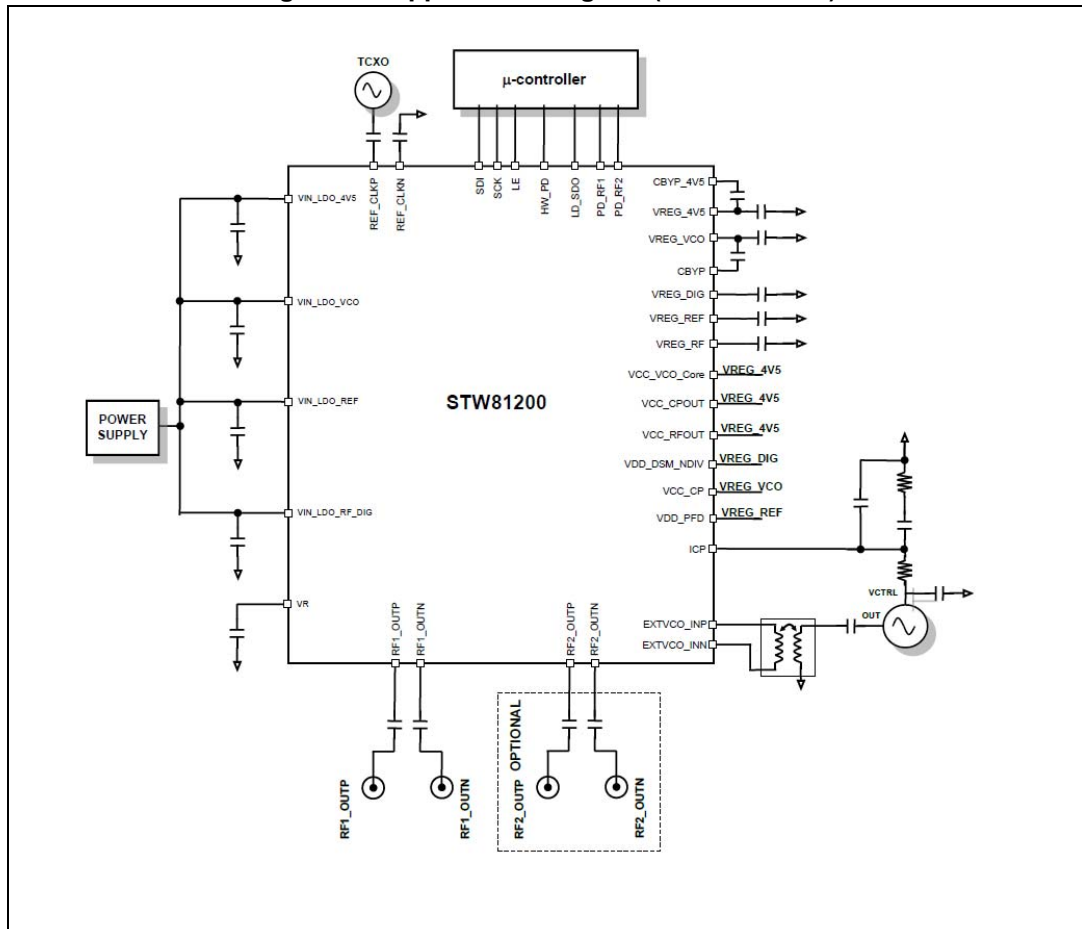

Note: This diagram shows a simplified schematic; the Evaluation Board schematic should be used as reference for connections and components values. Visit the STW81200 product page on the ST website www.st.com/stw81200ad to download the evaluation board data brief including PCB schematics.

8.2 Thermal PCB design considerations

The STW81200 QFN package offers a low thermal resistance ($\theta_{JC} \sim 3^{\circ}\text{C}/\text{W}$ on a JEDEC Multi-Layer Board). Preferred thermal flow in QFN package is through the bottom central pad.

The central thermal pad provides a solderable surface on the top of the PCB (for soldering the package die paddle on the board). Thermal vias are needed to provide a thermal path to the inner and bottom layers of the PCB in order to remove/dissipate the heat. The size of the thermal pad can be matched with the exposed die paddle, or it may be smaller taking into consideration clearance for vias to route the inner row signals.

A PCB can be designed to achieve a thermal impedance of 2 to $4^{\circ}\text{C}/\text{W}$ through a 1.6 mm (.063") thick FR-4 type PCB (a reliable, low cost solution).

For example the ST EVAL KIT uses a 0.8 mm thick PCB with a thermal impedance of $\sim 50^{\circ}\text{C}/\text{W}$ for a single via filled with solder. 25 vias are used, giving a thermal impedance of $\sim 2^{\circ}\text{C}/\text{W}$ with solder-filled vias ($50^{\circ}\text{C}/\text{W}$ divided by 25 vias).

Using a plate on the underside of the PCB (a common solution in STW81200 applications, as the plate is typically the metal housing of the application assembly) brings the total thermal resistance (junction to housing in the customer application) below $10^{\circ}\text{C}/\text{W}$.

As the typical power dissipation of the STW81200 is approximately 1.5 W, at maximum specified ambient temperature (85°C) a junction temperature of less than 100°C is attainable. This is well below the maximum specified value (125°C) to ensure safe operation of the STW81200 in worst-temperature conditions.

The ST EVAL KIT is not provided with additional heatsinking, and the thermal resistance (θ_{JA}) measured in the EVAL BOARD is $\sim 30^{\circ}\text{C}/\text{W}$.

9 Evaluation kit

An evaluation kit can be supplied upon request (Order Code: STW81200-EVB), including the following:

- Evaluation board
- GUI (graphical user interface) to configure the board and the STW81200 IC
- STWPLLSim software for PLL loop filter design and phase noise/transient simulation
- A comprehensive set of documentation (Evaluation board data brief including PCB schematics and GUI help, STWPLLSim User Manual).

The evaluation kit and the related SW and documentation can be ordered/downloaded from the ST website at the following address: www.st.com/stw81200ad.

Table 12. STW81200 order codes

Order Code	Description
STW81200-EVB	STW81200 Evaluation Kit (Evaluation Board, GUI and STWPLLSim tool)
STSW-RFSOL001	STWPLLSim simulation tool for STW81200
STSW-RFSOL002	GUI for configuring STW81200 evaluation board

10 Package information

In order to meet environmental requirements, ST offers these devices in different grades of ECOPACK® packages, depending on their level of environmental compliance. ECOPACK® specifications, grade definitions and product status are available at: www.st.com. ECOPACK® is an ST trademark.

10.1 VFQFPN36 package information

Figure 35. VFQFPN - 36 pin, 6x6 mm, 0.5 mm pitch very thin profile fine pitch quad flat package outline

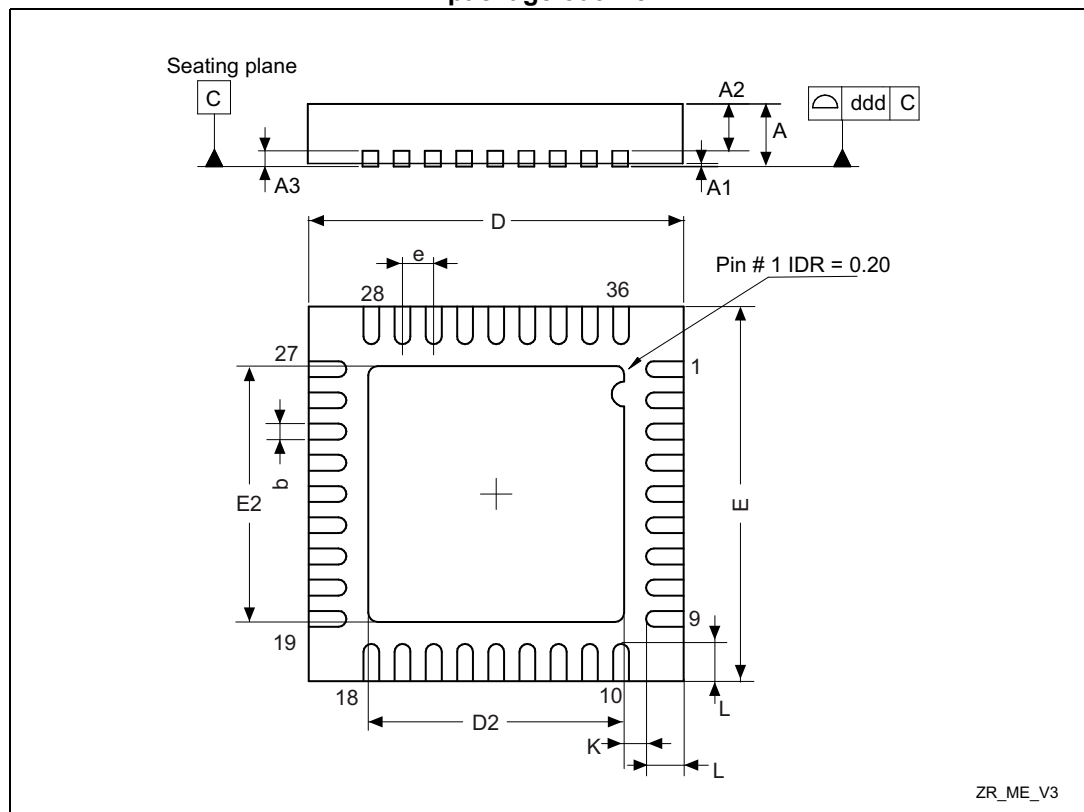

1. Drawing is not to scale.

Table 13. VFQFPN - 36 pin, 6x6 mm, 0.5 mm pitch very thin profile fine pitch quad flat package mechanical data

Symbol	millimeters			inches ⁽¹⁾		
	Min	Typ	Max	Min	Typ	Max
A	0.800	0.900	1.000	0.0315	0.0354	0.0394
A1	-	0.020	0.050	-	0.0008	0.0020
A2	-	0.650	1.000	-	0.0256	0.0394
A3	-	0.200	-	-	0.0079	-
b	0.180	0.230	0.300	0.0071	0.0091	0.0118
D	5.875	6.000	6.125	0.2313	0.2362	0.2411
D2	4.00	4.10	4.20	0.1575	0.1614	0.1654
E	5.875	6.000	6.125	0.2313	0.2362	0.2411
E2	4.00	4.10	4.20	0.1575	0.1614	0.1654
e	0.450	0.500	0.550	0.0177	0.0197	0.0217
L	0.350	0.550	0.750	0.0138	0.0217	0.0295
K	0.250	-	-	0.0098	-	-
ddd	-	-	0.080	-	-	0.0031

1. Values in inches are converted from mm and rounded to 4 decimal digits.

Figure 36. VFQFPN - 36 pin, 6x6 mm, 0.5 mm pitch very thin profile fine pitch quad flat package recommended footprint

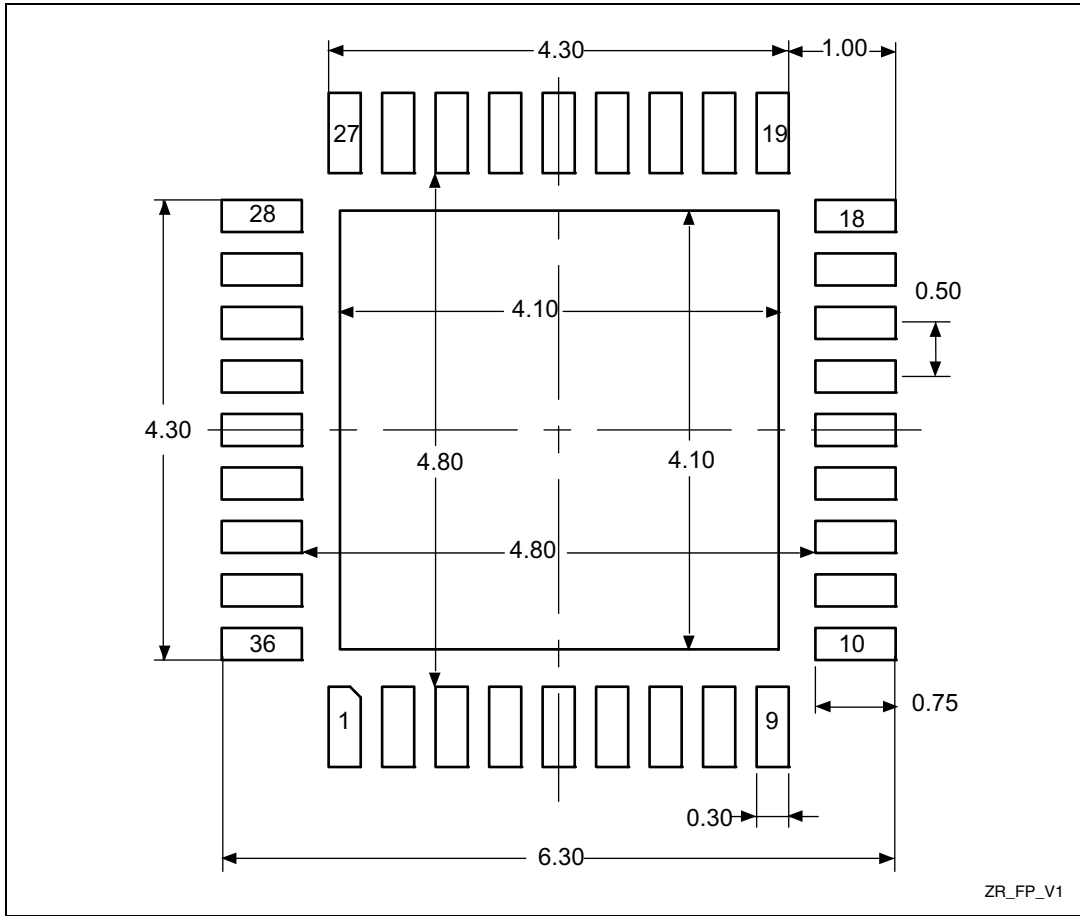

1. Dimensions are expressed in millimeters.

11 Revision history

Table 14. Document revision history

Date	Revision	Changes
21-Feb-2014	1	Initial release.
07-Apr-2014	2	Removed confidential banner
04-Sep-2014	3	Added HBM footnote in Table 3: Absolute maximum ratings Updated device ID in ST11 Register on page 50 Updated to use latest corporate template and legal disclaimer.
23-Sep-2014	4	Changed 'Multi-band' to 'Wideband' in document title.
12-Jun-2015	5	Renamed pin 14 to VDD_CP in Table 2: Pin description . Added IOL and IOH values in Table 5: Digital logic levels Updated parameter V_{ICP} in Table 6: Electrical specifications Updated Figure 9 through Figure 28 Added Section 7.3.1: Fractional spurs and compensation mechanism . Updated <ul style="list-style-type: none"> – Section 7.6: Charge pump. – Section 7.9: Voltage controlled oscillators (VCOs) – Section 7.10: RF output divider stage – Section 7.11: Low-power functional modes – Section 7.12: LDO voltage regulators Updated ST0 register description in Table 11: SPI Register map (address 12 to 15 not available) Updated following register bitfield descriptions: <ul style="list-style-type: none"> – STW81200 register descriptions bit PFD_DEL – ST3 Register bits CP_LEAK and DNSPLIT_EN – ST4 Register bit RF_OUT_PWR – ST6 Register bit MAN_CALB_EN – ST8 Register bit REG_VCO_4V5_VOUT – ST10 Register bit REG_VCO_OCP Updated Section 7.17: Example of register programming Added notes to Figure 33 and Figure 34 Added Section 9: Evaluation kit Re formatted Section 10: Package information to comply with latest corporate guidelines.
08-Jul-2015	6	Regenerated for XML generation.
04-Jan-2016	7	Updated parameter K_{VCO} in Table 6: Electrical specifications Updated: <ul style="list-style-type: none"> – Section 7.6: Charge pump – Section 7.16: Power ON sequence. Re-named Section 8: Application information , and added Section 8.2: Thermal PCB design considerations . In Table 6: Electrical specifications updated dimensions D2 and E2.

Table 14. Document revision history

Date	Revision	Changes
09-Aug-2019	8	Updated Section 7.9: Voltage controlled oscillators (VCOs) . Detailed VCO_CALB_DISABLE bit in ST0 Register . Updated Section 10: Package information .

IMPORTANT NOTICE – PLEASE READ CAREFULLY

STMicroelectronics NV and its subsidiaries (“ST”) reserve the right to make changes, corrections, enhancements, modifications, and improvements to ST products and/or to this document at any time without notice. Purchasers should obtain the latest relevant information on ST products before placing orders. ST products are sold pursuant to ST’s terms and conditions of sale in place at the time of order acknowledgement.

Purchasers are solely responsible for the choice, selection, and use of ST products and ST assumes no liability for application assistance or the design of Purchasers’ products.

No license, express or implied, to any intellectual property right is granted by ST herein.

Resale of ST products with provisions different from the information set forth herein shall void any warranty granted by ST for such product.

ST and the ST logo are trademarks of ST. For additional information about ST trademarks, please refer to www.st.com/trademarks. All other product or service names are the property of their respective owners.

Information in this document supersedes and replaces information previously supplied in any prior versions of this document.

© 2019 STMicroelectronics – All rights reserved

Mouser Electronics

Authorized Distributor

Click to View Pricing, Inventory, Delivery & Lifecycle Information:

[STMicroelectronics:](#)

[STW81200T](#) [STW81200TR](#)