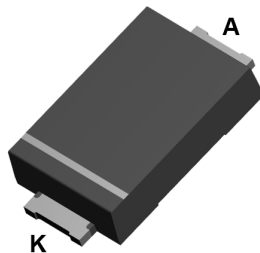
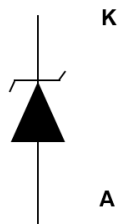


## 400 W TVS in SMA Flat



**SMA Flat**  
(Jedec DO221-AC)



**Unidirectional**

### Features

- Peak pulse power: 400 W (10/1000  $\mu$ s) and 2.5 kW (8/20  $\mu$ s)
- Flat and thin package: 1 mm
- Stand-off voltage range from 5 V to 188 V
- Unidirectional type
- Low leakage current: 0.2  $\mu$ A at 25 °C and 1  $\mu$ A at 85 °C
- Operating  $T_j$  max: 175 °C
- High power capability at  $T_j$  max.: up to 200 W (10/1000  $\mu$ s)
- Lead finishing: matte tin plating

### Complies with the following standards

- UL94, V0
- J-STD-020 MSL level 1
- J-STD-002, JESD 22-B102 E3 and MIL-STD-750, method 2026
- JESD-201 class 2 whisker test
- IPC7531 footprint and JEDEC registered package outline
- IEC 61000-4-2, C = 150 pF - R = 330  $\Omega$  exceeds level 4:
  - 30 kV (contact discharge)
  - 30 kV (air discharge)
- IEC 61000-4-4
  - 4 kV

### Description

The SMA4F Transil series are designed to protect sensitive circuits against transient surges.

The planar technology makes it compatible with high-end circuits where low leakage current and high junction temperature are required to provide long term reliability and stability.

#### Product status link

SMA4F	<a href="#">SMA4F5.0A</a> , <a href="#">SMA4F6.0A</a> , <a href="#">SMA4F6.5A</a> , <a href="#">SMA4F8.5A</a> , <a href="#">SMA4F10A</a> , <a href="#">SMA4F11A</a> , <a href="#">SMA4F12A</a> , <a href="#">SMA4F13A</a> , <a href="#">SMA4F14A</a> , <a href="#">SMA4F15A</a> , <a href="#">SMA4F16A</a> , <a href="#">SMA4F18A</a> , <a href="#">SMA4F20A</a> , <a href="#">SMA4F22A</a> , <a href="#">SMA4F23A</a> , <a href="#">SMA4F24A</a> , <a href="#">SMA4F26A</a> , <a href="#">SMA4F28A</a> , <a href="#">SMA4F30A</a> , <a href="#">SMA4F31A</a> , <a href="#">SMA4F33A</a> , <a href="#">SMA4F36A</a> , <a href="#">SMA4F40A</a> , <a href="#">SMA4F48A</a> , <a href="#">SMA4F58A</a> , <a href="#">SMA4F64A</a> , <a href="#">SMA4F70A</a> , <a href="#">SMA4F85A</a> , <a href="#">SMA4F100A</a> , <a href="#">SMA4F130A</a> , <a href="#">SMA4F154A</a> , <a href="#">SMA4F170A</a> , <a href="#">SMA4F188A</a>
-------	---

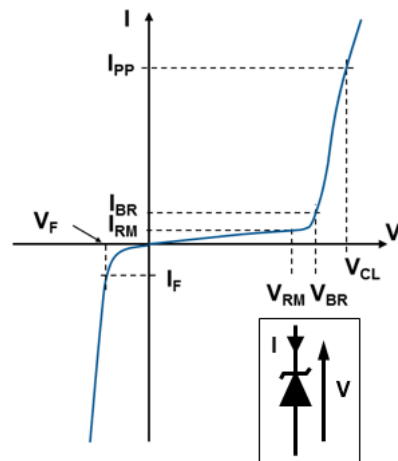
# 1 Characteristics

**Table 1. Absolute maximum ratings ( $T_{amb} = 25\text{ }^{\circ}\text{C}$ )**

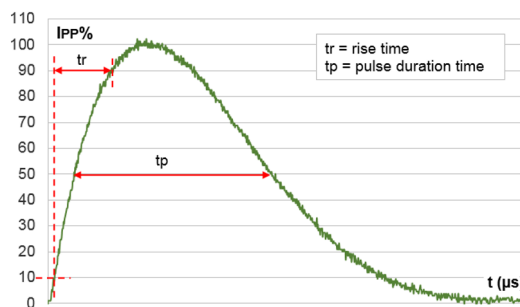
Symbol	Parameter	Value	Unit	
$V_{PP}$	Peak pulse voltage	IEC 61000-4-2 (C = 150 pF, R = 330 $\Omega$ )	kV	
		Contact discharge		30
		Air discharge		30
$P_{PP}$	Peak pulse power dissipation	10/1000 $\mu\text{s}$ , $T_j$ initial = $T_{amb}$	400	W
$T_{stg}$	Storage temperature range		-65 to +175	$^{\circ}\text{C}$
$T_j$	Operating junction temperature range		-55 to +175	$^{\circ}\text{C}$
$T_L$	Maximum lead temperature for soldering during 10 s		260	$^{\circ}\text{C}$

**Figure 1. Electrical characteristics - parameter definitions**

- $V_{RM}$  Maximum stand-off voltage
- $I_{RM}$  Maximum leakage current @  $V_{RM}$
- $V_R$  Stand-off voltage
- $I_R$  Leakage current @  $V_R$
- $V_{BR}$  Breakdown voltage @  $I_{BR}$
- $I_{BR}$  Breakdown current
- $V_{CL}$  Clamping voltage @  $I_{PP}$
- $I_{PP}$  Peak pulse current
- $R_D$  Dynamic resistance
- $V_F$  Forward voltage drop @  $I_F$
- $I_F$  Forward current
- $\alpha T$  Voltage temperature coefficient



**Figure 2. Pulse definition for electrical characteristics**



**Table 2. Electrical characteristics - parameter values ( $T_{amb} = 25\text{ }^{\circ}\text{C}$ , unless otherwise specified)**

Type	$I_{RM}$ max at $V_{RM}$			$V_{BR}$ at $I_R^{(1)}$				10 / 1000 $\mu\text{s}$			8 / 20 $\mu\text{s}$			$\alpha T$
								$V_{CL}^{(2)(3)}$	$I_{PP}^{(4)}$	$R_D$	$V_{CL}^{(2)(3)}$	$I_{PP}^{(4)}$	$R_D$	
	25 $^{\circ}\text{C}$	85 $^{\circ}\text{C}$		Min.	Typ.	Max.		Max.		Max.	Max.	Max.		
	$\mu\text{A}$	V		V			mA	V	A	$\Omega$	V	A	$\Omega$	$10^{-4}/^{\circ}\text{C}$
SMA4F5.0A	20	50	5.0	6.4	6.74	7.1	10	9.2	43.5	0.048	13.4	174	0.036	5.7
SMA4F6.0A	20	50	6.0	6.7	7.05	7.4	10	10.3	38.8	0.075	13.7	170	0.037	5.9
SMA4F6.5A	20	50	6.5	7.2	7.58	8	10	11.2	35.7	0.09	14.5	160	0.041	6.1
SMA4F8.5A	20	50	8.5	9.4	9.9	10.4	1	14.4	27.7	0.144	19.5	124	0.073	7.3
SMA4F10A	0.2	1	10	11.1	11.7	12.3	1	17	23.5	0.2	21.7	106	0.089	7.8
SMA4F11A	0.2	1	11	12.3	13	13.7	1	18	21.8	0.216	24.2	96	0.11	8.1
SMA4F12A	0.2	1	12	13.3	14	14.7	1	19.9	20.1	0.259	25.3	91	0.116	8.3
SMA4F13A	0.2	1	13	14.4	15.2	16	1	21.5	18.6	0.296	27.2	85	0.132	8.4
SMA4F14A	0.2	1	14	15.7	16.5	17.3	1	23.1	17.2	0.337	29	79	0.148	8.6
SMA4F15A	0.2	1	15	16.7	17.6	18.5	1	24.4	16.4	0.36	32.5	71	0.197	8.8
SMA4F16A	0.2	1	16	17.9	18.8	19.8	1	26	15.4	0.403	34.7	67	0.222	9.0
SMA4F18A	0.2	1	18	20	21.1	22.2	1	29.2	13.7	0.511	39.3	59	0.29	9.2
SMA4F20A	0.2	1	20	22.2	23.4	24.6	1	32.4	12.3	0.634	42.8	54	0.337	9.4
SMA4F22A	0.2	1	22	24.4	25.7	27	1	35.5	11.2	0.759	48.3	48	0.444	9.6
SMA4F23A	0.2	1	23	25.7	27	28.4	1	37.8	10.6	0.888	49.2	47	0.444	9.6
SMA4F24A	0.2	1	24	26.7	28.1	29.5	1	38.9	10.3	0.913	50	46	0.446	9.6
SMA4F26A	0.2	1	26	28.9	30.4	31.9	1	42.1	9.5	1.07	53.5	43	0.502	9.7
SMA4F28A	0.2	1	28	31.1	32.7	34.3	1	45.4	8.8	1.26	59	39	0.633	9.8
SMA4F30A	0.2	1	30	33.2	35	36.8	1	48.4	8.3	1.39	64.3	36	0.761	9.9
SMA4F31A	0.2	1	31	34.2	36	37.8	1	50.2	8	1.56	65	35	0.77	9.9
SMA4F33A	0.2	1	33	36.7	38.6	40.5	1	53.3	7.5	1.71	69.7	33	0.885	10
SMA4F36A	0.2	1	36	40	42.1	44.2	1	58.1	6.9	2.01	76	30	1.06	10
SMA4F40A	0.2	1	40	44.4	46.7	49	1	64.5	6.2	2.5	84	27	1.3	10.1
SMA4F48A	0.2	1	48	53.2	56	58.8	1	77.4	5.2	3.56	100	23	1.79	10.3
SMA4F58A	0.2	1	58	64.6	68	71.4	1	93.6	4.3	5.21	121	19	2.62	10.4
SMA4F64A	0.2	1	64	71.1	74.8	78.6	1	103	3.9	6.25	134	17	3.25	10.5
SMA4F70A	0.2	1	70	77.9	82	86.1	1	113	3.5	7.71	146	16	3.75	10.5
SMA4F85A	0.2	1	85	95	100	105	1	137	2.9	11.4	178	13	5.69	10.6
SMA4F100A	0.2	1	100	111	117	123	1	162	2.5	15.6	212	11	8.09	10.7
SMA4F130A	0.2	1	130	144	152	160	1	209	1.9	25.8	265	9	11.7	10.8
SMA4F154A	0.2	1	154	171	180	189	1	246	1.6	35.6	317	7	18.3	10.8
SMA4F170A	0.2	1	170	190	200	210	1	275	1.4	47	353	6.5	22.2	10.8
SMA4F188A	0.2	1	188	209	220	231	1	328	1.4	69.3	388	6	26.2	10.8

1. To calculate  $V_{BR}$  versus  $T_j$ :  $V_{BR}$  at  $T_j = V_{BR}$  at  $25\text{ }^{\circ}\text{C} \times (1 + \alpha T \times (T_j - 25))$
2. To calculate  $V_{CL}$  versus  $T_j$ :  $V_{CL}$  at  $T_j = V_{CL}$  at  $25\text{ }^{\circ}\text{C} \times (1 + \alpha T \times (T_j - 25))$
3. To calculate  $V_{CLmax}$  versus  $I_{PPappli}$ :  $V_{CLmax} = V_{BRmax} + R_D \times I_{PPappli}$

4. Surge capability given for both directions

1.1 Characteristics (curves)

Figure 3. Maximum peak power dissipation versus initial junction temperature

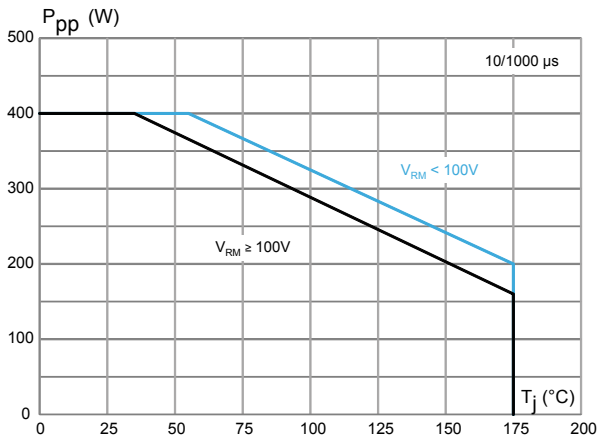


Figure 4. Maximum peak pulse power versus exponential pulse duration

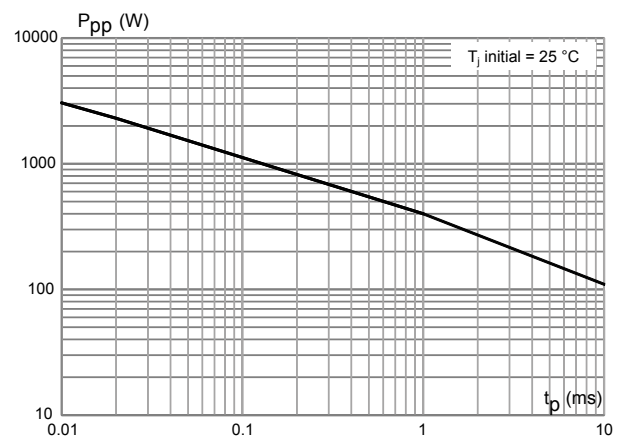


Figure 5. Maximum clamping voltage versus peak pulse current

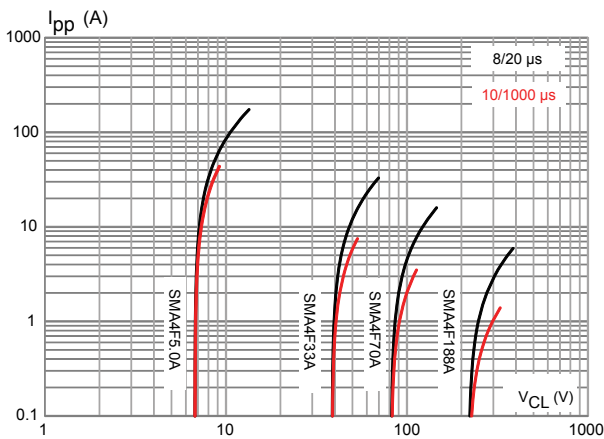


Figure 6. Dynamic resistance versus pulse duration

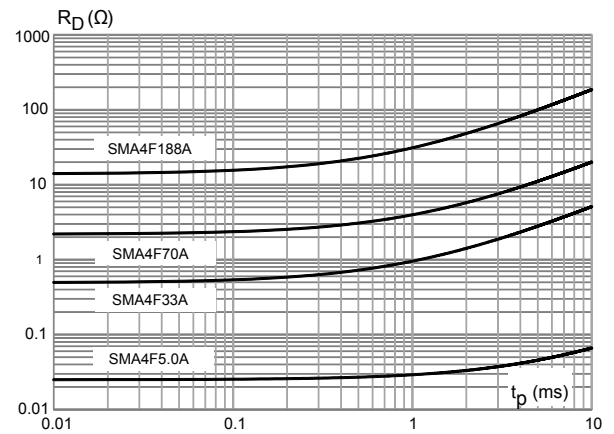


Figure 7. Junction capacitance versus reverse applied voltage

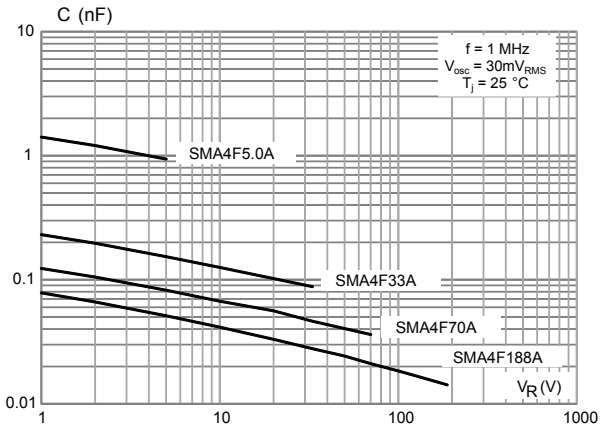


Figure 8. Leakage current versus junction temperature

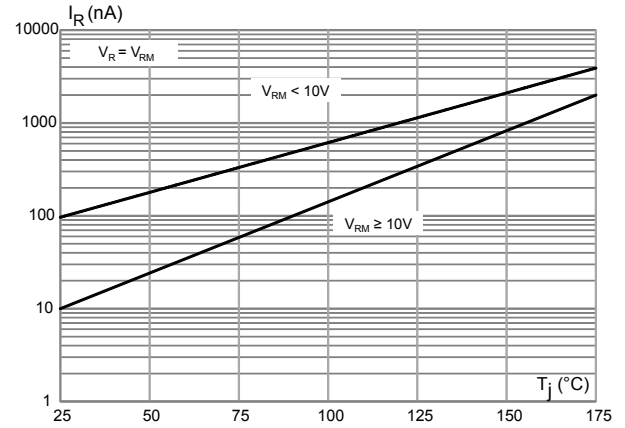


Figure 9. Peak forward voltage drop versus peak forward current

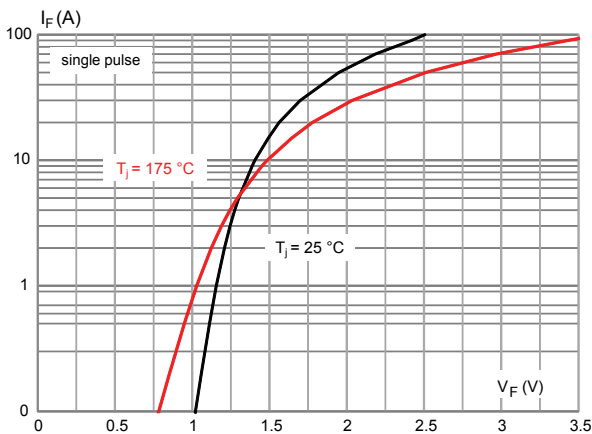


Figure 10. Thermal impedance junction to ambient versus pulse duration

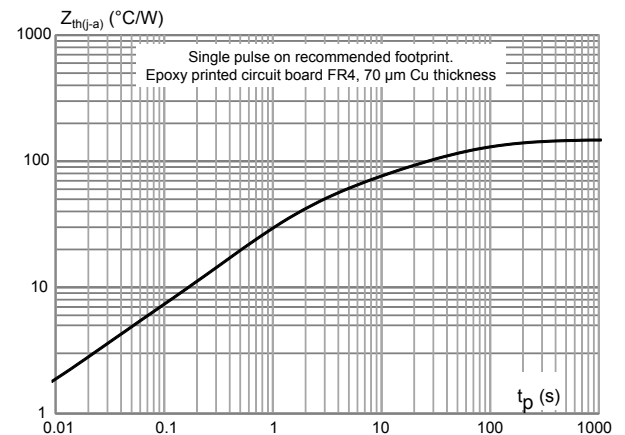
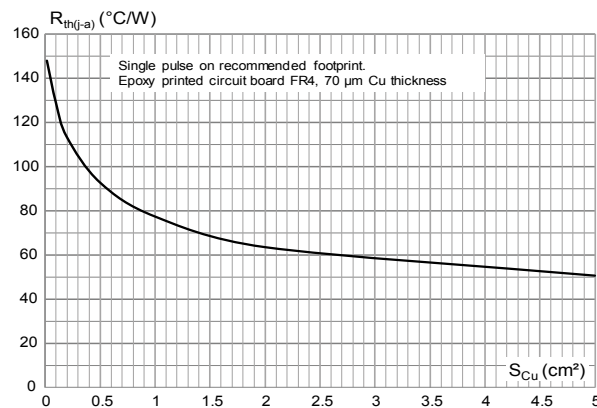


Figure 11. Thermal resistance junction to ambient versus copper area under each lead



## 2 Package information

In order to meet environmental requirements, ST offers these devices in different grades of **ECOPACK** packages, depending on their level of environmental compliance. ECOPACK specifications, grade definitions and product status are available at: [www.st.com](http://www.st.com). ECOPACK is an ST trademark.

### 2.1 SMA Flat package information

Figure 12. SMA Flat package outline

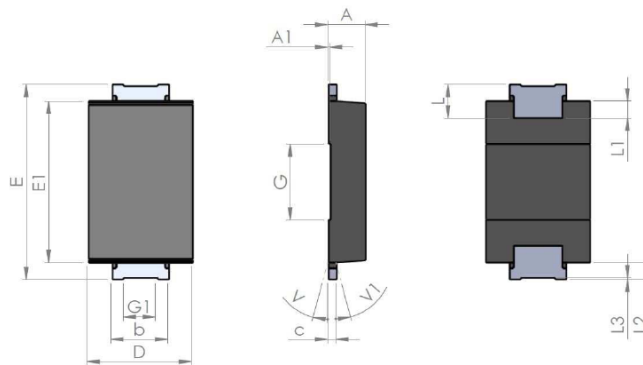
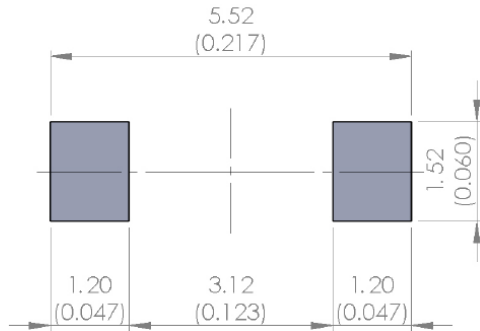


Table 3. SMA Flat mechanical data

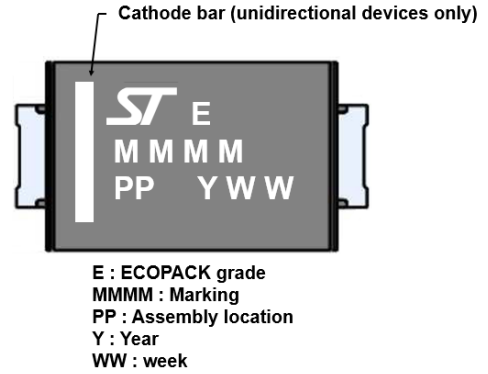
Symbol	Millimeters			Inches <sup>(1)</sup>		
	Min	Typ	Max	Min	Typ	Max
A	0.90		1.10	0.035		0.044
A1		0.05			0.002	
b	1.25		1.65	0.049		0.065
c	0.15		0.40	0.005		0.016
D	2.25		2.90	0.088		0.115
E	5.00		5.35	0.196		0.211
E1	3.95		4.60	0.155		0.182
G		2.00			0.079	
G1		0.85			0.033	
L	0.75		1.20	0.029		0.048
L1		0.45			0.018	
L2		0.45			0.018	
L3		0.05			0.002	
V			8°			8°
V1			8°			8°

1. Values in inches are converted from mm and rounded to 3 decimal digits.

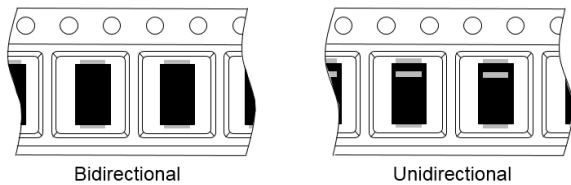
**Figure 13. SMA Flat recommended footprint in mm (inches)**



**Figure 14. SMA Flat marking**

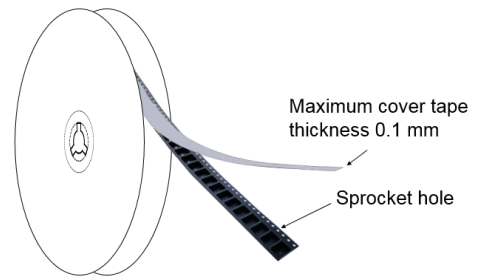


**Figure 15. Package orientation in reel**

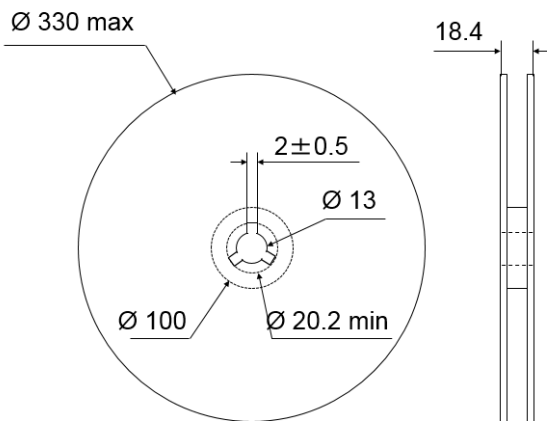


Taped according to EIA-481  
 Pocket dimensions are not on scale.  
 Pocket shape may vary depending on package  
 On bidirectional devices, marking and logo may not be always in the same direction.

**Figure 16. Tape and reel orientation**



**Figure 17. 13" reel dimension values**



**Figure 18. Inner box dimension values**

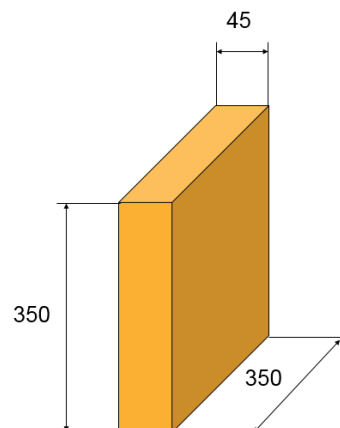


Figure 19. Tape outline



Note: Pocket dimensions are not on scale  
Pocket shape may vary depending on package

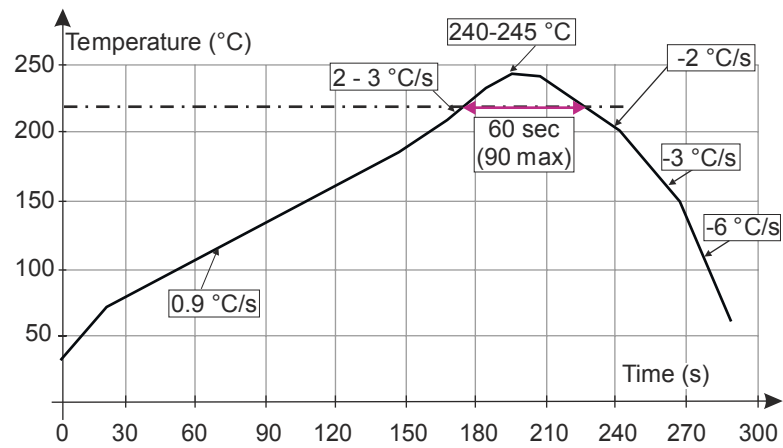
Table 4. Tape dimension values

Ref.	Dimensions		
	Millimeters		
	Min.	Typ.	Max.
D0	1.5	1.55	1.6
D1	1.5		
F	5.4	5.5	5.6
K0	1.1	1.2	1.3
P0	3.9	4.0	4.1
P1	3.9	4.0	4.1
P2	1.9	2.0	2.1
W	11.7	12	12.3



## 2.2 Reflow profile

Figure 20. ST ECOPACK recommended soldering reflow profile for PCB mounting



Note: Minimize air convection currents in the reflow oven to avoid component movement. Maximum soldering profile corresponds to the latest IPC/JEDEC J-STD-020.

### 3 SMA4F Ordering information

Figure 21. Ordering information scheme

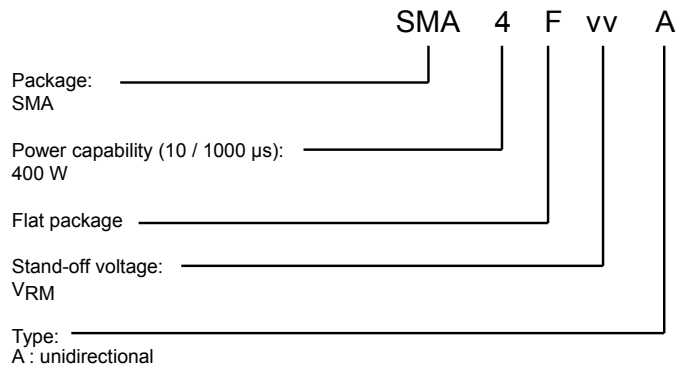


Table 5. Ordering information

Order code	Marking	Package	Weight	Base qty.	Delivery mode
SMA4FxxxA	See Section 3.1 Marking.	SMA Flat	39 mg	10000	Tape and reel

### 3.1 Marking

**Table 6. Marking**

Order code	Marking
SMA4F5.0A	4AI
SMA4F6.0A	4AK
SMA4F6.5A	4AL
SMA4F8.5A	4AP
SMA4F10A	4AS
SMA4F11A	4AU
SMA4F12A	4AW
SMA4F13A	4AY
SMA4F14A	4BA
SMA4F15A	4BC
SMA4F16A	4BE
SMA4F18A	4BI
SMA4F20A	4BM
SMA4F22A	4BO
SMA4F23A	4BP
SMA4F24A	4BQ
SMA4F26A	4BS
SMA4F28A	4BU
SMA4F30A	4BW
SMA4F31A	4BX
SMA4F33A	4BZ
SMA4F36A	4CC
SMA4F40A	4CG
SMA4F48A	4CO
SMA4F58A	4CY
SMA4F64A	4DE
SMA4F70A	4DK
SMA4F85A	4DZ
SMA4F100A	4EO
SMA4F130A	4FS
SMA4F154A	4GQ
SMA4F170A	4HG
SMA4F188A	4HY

## Revision history

**Table 7. Document revision history**

Date	Version	Changes
28-May-2018	1	Initial release.
19-Feb-2019	2	Updated links syntax.
02-Sep-2019	3	Updated <a href="#">Table 1</a> . Absolute maximum ratings ( $T_{amb} = 25\text{ °C}$ ), <a href="#">Figure 10</a> . Thermal impedance junction to ambient versus pulse duration and <a href="#">Figure 11</a> . Thermal resistance junction to ambient versus copper area under each lead.
25-Nov-2019	4	Updated links syntax.

**IMPORTANT NOTICE – PLEASE READ CAREFULLY**

STMicroelectronics NV and its subsidiaries (“ST”) reserve the right to make changes, corrections, enhancements, modifications, and improvements to ST products and/or to this document at any time without notice. Purchasers should obtain the latest relevant information on ST products before placing orders. ST products are sold pursuant to ST’s terms and conditions of sale in place at the time of order acknowledgement.

Purchasers are solely responsible for the choice, selection, and use of ST products and ST assumes no liability for application assistance or the design of Purchasers’ products.

No license, express or implied, to any intellectual property right is granted by ST herein.

Resale of ST products with provisions different from the information set forth herein shall void any warranty granted by ST for such product.

ST and the ST logo are trademarks of ST. For additional information about ST trademarks, please refer to [www.st.com/trademarks](http://www.st.com/trademarks). All other product or service names are the property of their respective owners.

Information in this document supersedes and replaces information previously supplied in any prior versions of this document.

© 2019 STMicroelectronics – All rights reserved

# Mouser Electronics

Authorized Distributor

Click to View Pricing, Inventory, Delivery & Lifecycle Information:

## STMicroelectronics:

[SMA4F20A](#) [SMA4F15A](#) [SMA4F6.5A](#) [SMA4F14A](#) [SMA4F11A](#) [SMA4F22A](#) [SMA4F24A](#) [SMA4F12A](#) [SMA4F31A](#)  
[SMA4F26A](#) [SMA4F10A](#) [SMA4F16A](#) [SMA4F6.0A](#) [SMA4F8.5A](#) [SMA4F33A](#) [SMA4F28A](#) [SMA4F30A](#) [SMA4F18A](#)  
[SMA4F23A](#) [SMA4F13A](#) [SMA4F5.0A](#) [SMA4F85A](#) [SMA4F170A](#) [SMA4F70A](#) [SMA4F154A](#) [SMA4F130A](#) [SMA4F188A](#)  
[SMA4F100A](#) [SMA4F36A](#) [SMA4F40A](#) [SMA4F64A](#) [SMA4F48A](#) [SMA4F58A](#)