

Product Overview

The QPA2513 is a 2-stage S-Band internally matched GaN Power Amplifier Module. The QPA2513 operates at pulsed RF CW in frequency range 3.1–3.5 GHz providing typically 51dBm of saturated output power with 30dB of large-signal gain and 62% of power added efficiency. The QPA2513 is matched to 50 Ohms with integrated bias circuits and DC blocking capacitor at input port. The QPA2513 in a SMD package that provides good thermal properties and ideal for use in both commercial and military radar systems.

Evaluation boards are available upon request.

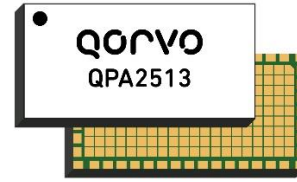

25.0 x 12.5 x 3.488 mm SMD

Key Features

- Operating Frequency Range: 3.1 – 3.5 GHz
- Saturated Output Power P_{SAT} : 51dBm ⁽¹⁾ ⁽²⁾
- Power Added Efficiency at P_{SAT} : 62% ⁽¹⁾ ⁽²⁾
- Large Signal Gain at P_{SAT} : 30.4 dB ⁽¹⁾ ⁽²⁾
- Bias: $V_{DS1,2}=+50V$, $I_{DQ1}=36mA$, $I_{DQ2}=192mA$
- Package Type: SMD
- Package Dimensions: 25.0x12.5x3.488mm

Notes:

1. Pulsed RF signal on a reference fixture plane.
2. 3 dB gain compression.

Performance is typical across frequency. Please reference electrical specification table and data plots for more details.

Functional Block Diagram

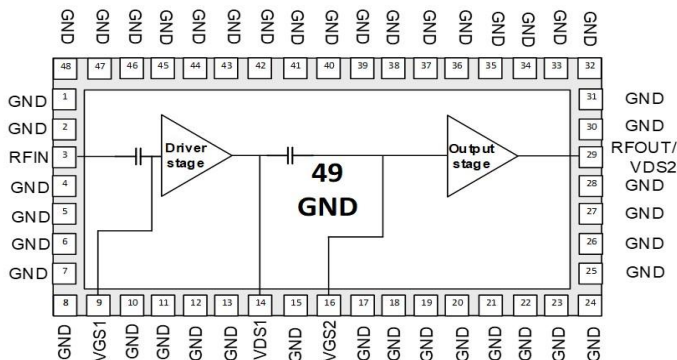

Applications

- Military Radar
- Commercial Radar

Ordering Information

Part Number	Description
QPA2513	QPA2513 50 Piece Tray
QPA2513EVB04	QPA2513 Evaluation Board

Absolute Maximum Ratings

Parameter	Rating
Breakdown Voltage (BV_{DG})	+145 V
Gate Voltage ($V_{G1,2}$)	-7 to +2 V
Drain Voltage ($V_{D1,2}$)	+55 V
RF Input Power, 50 Ohm load ⁽³⁾⁽⁴⁾	24 dBm
RF Input Power, 10:1 output VSWR ⁽³⁾⁽⁴⁾	21 dBm
Channel Temperature	275°C
Storage Temperature	-65 to +150°C

Notes:

3. At temperature +25°C

4. Pulse signal 10% Duty Cycle, 100 μ s Pulse Width

Exceeding any one or a combination of the Absolute Maximum Rating conditions may cause permanent damage to the device. Extended application of Absolute Maximum Rating conditions to the device may reduce device reliability.

Recommended Operating Conditions

Parameter	Min	Typ	Max	Unit
Driver Stage Gate Voltage (V_{G1})		-2.7		V
Output Stage Gate Voltage (V_{G2})		-2.7		V
Drain Voltage ($V_{D1,2}$)		+50		V
Driver Quiescent Current (I_{DQ1})		36		mA
Output Stage Quiescent Current (I_{DQ1})		192		mA
Operating Temperature	-40		+85	°C

Electrical specifications are measured at specified test conditions. Specifications are not guaranteed over all recommended operating conditions.

Electrical Specifications

Parameter	Conditions	Min	Typ	Max	Units
Operating Frequency Range		3.1		3.5	GHz
Saturated Output Power	3 dB Gain Compression		51		dBm
Large Signal Gain	$P_{SAT} = 51$ dBm		30.4		dB
Power Added Efficiency	$P_{SAT} = 51$ dBm		62		%
Small Signal Gain	Frequency Range 3.1-3.5 GHz		33.4		dB
Input Return Loss	Frequency Range 3.1-3.5 GHz		-10.7		dB
Output Return Loss	Frequency Range 3.1-3.5 GHz		-7		dB
Driver Stage Gate Leakage (I_{G1})	$V_{G1} = -3.7$ V, $V_{D1} = +10$ V	-3.6			mA
Output Stage Gate Leakage (I_{G2})	$V_{G2} = -3.7$ V, $V_{D2} = +10$ V	-19.2			mA

Test conditions unless otherwise noted: $V_{D1,2} = +50$ V, $I_{DQ1} = 36$ mA, $I_{DQ2} = 192$ mA, $T = +25$ °C, Pulsed RF CW (Duty Cycle = 10%, Width = 100 μ s) on a reference fixture plane for 3.1-3.5 GHz.

Thermal Information

Parameter	Test Conditions	Values	Units
Thermal Resistance (θ_{JC}) ⁽⁵⁾⁽⁶⁾	$T_{CASE} = +85$ °C, $V_{DS1,2} = +50$ V, $I_{DQ1} = 36$ mA, $I_{DQ2} = 192$ mA.	0.97	°C/W
Peak IR Surface Temperature (T_{CH}) ⁽⁵⁾⁽⁶⁾	$P_{DISS} = 89.8$ W, Pulsed RF CW	144	°C

Notes:

5. Thermal resistance is measured to package backside.

6. Pulsed CW (Duty Cycle = 10%, Pulse Width = 100 μ s).

7. Refer to the following document: [GaN Device Channel Temperature, Thermal Resistance, and Reliability Estimates](#)

QPA2513 EVB Performance Plots – 3100 – 3500 MHz Reference Design

Notes: See page 9 for device reference planes where the performance was measured.

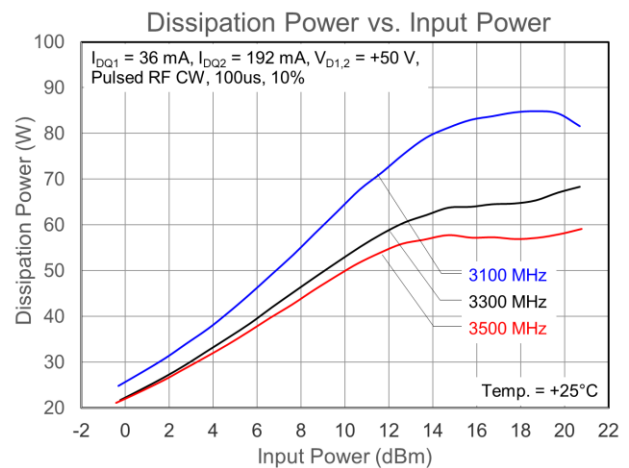
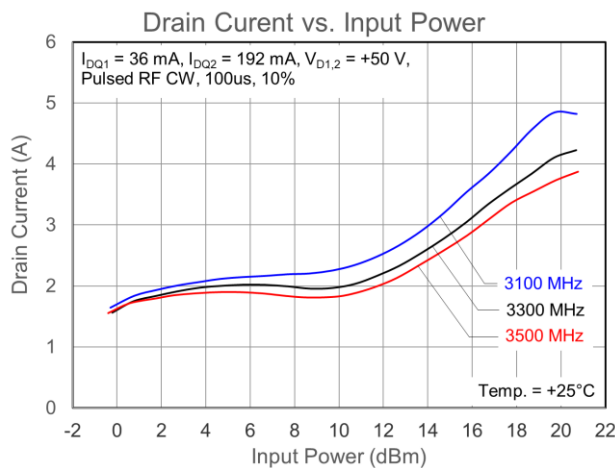
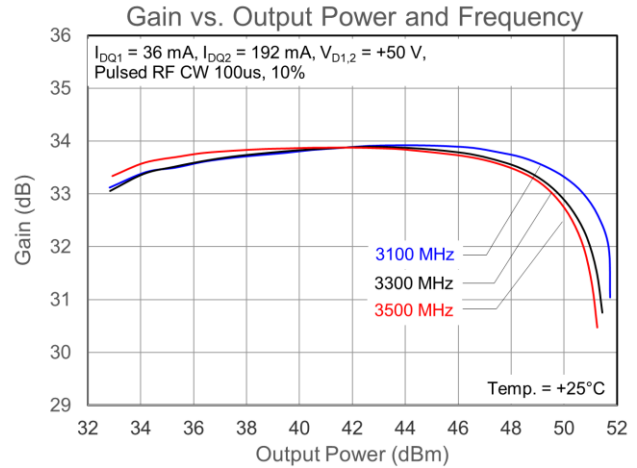
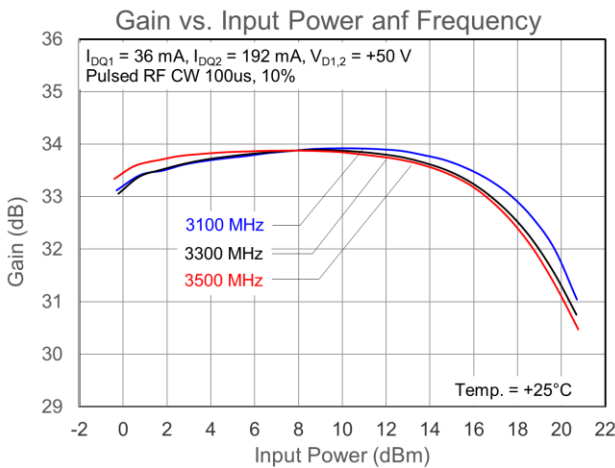
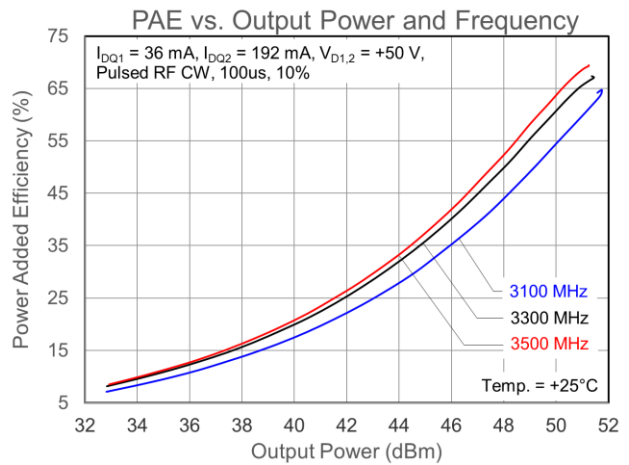
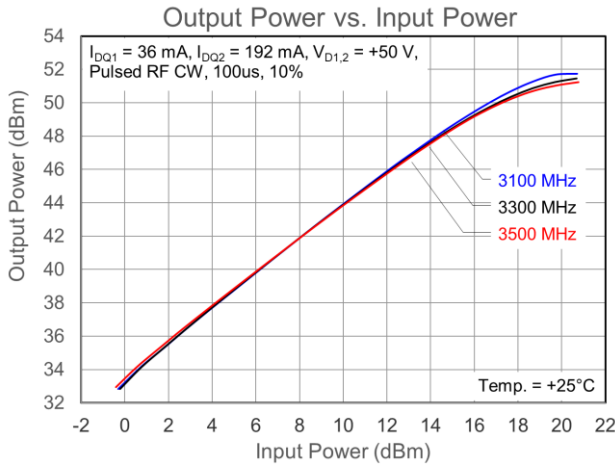

QPA2513 EVB Performance Plots – 3100 – 3500 MHz Reference Design

Notes: See page 9 for device reference planes where the performance was measured.

2nd Harmonic vs. Pin and Frequency

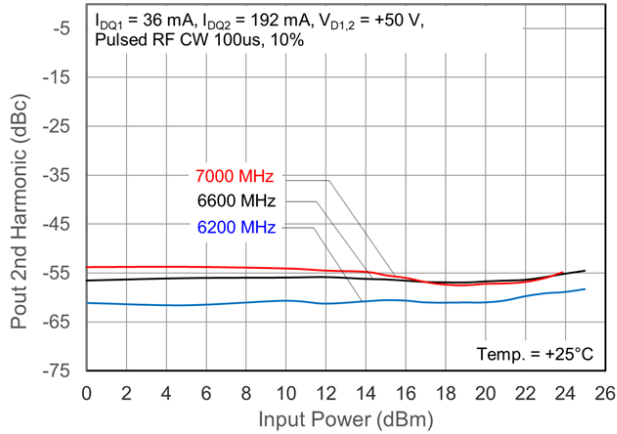

3rd Harmonic vs. Pin and Frequency

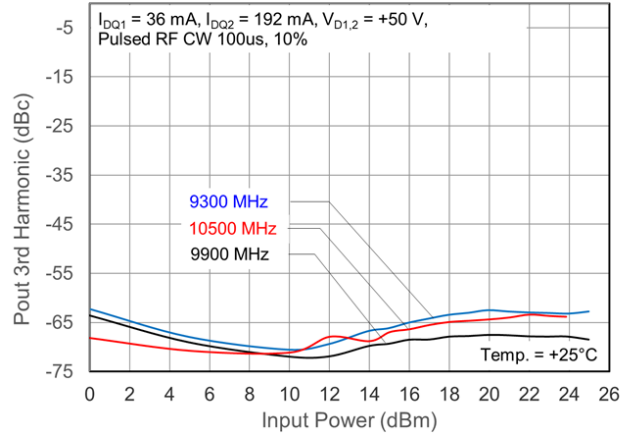

Output Power vs. Input Power and Temp

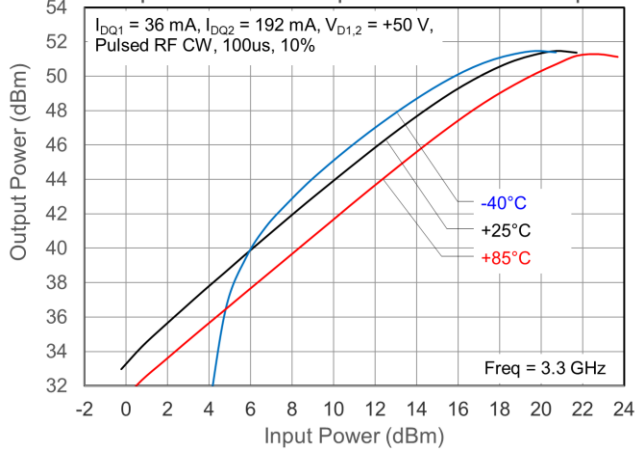

PAE vs. Input Power and Temp

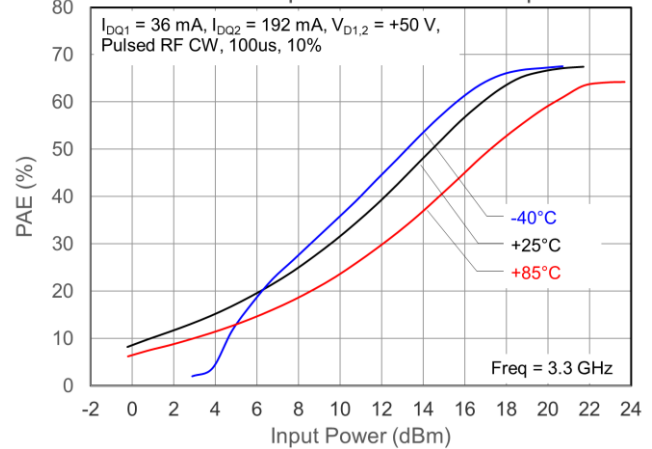

Gain vs. Input Power and Temp

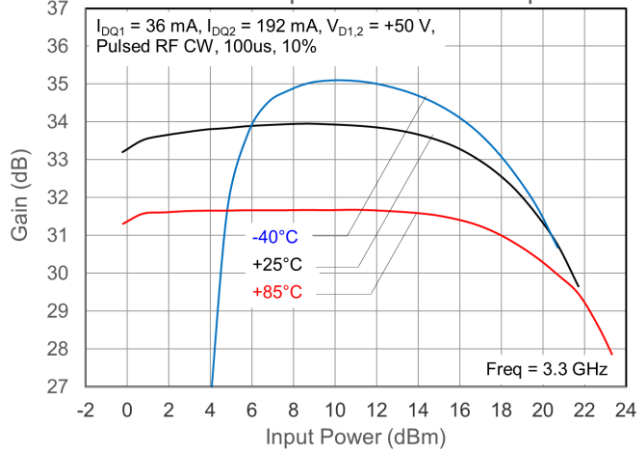

QPA2513 EVB Performance Plots at 3dB Gain Compression

Notes: See page 9 for device reference planes where the performance was measured.

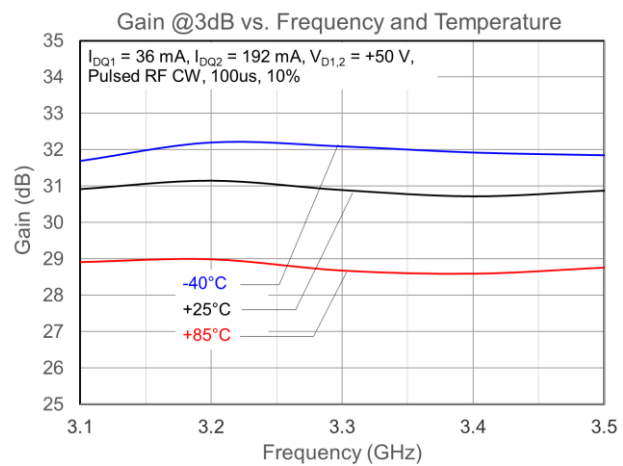
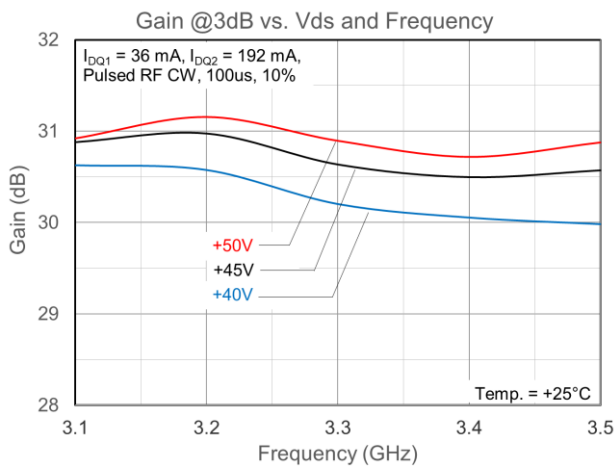
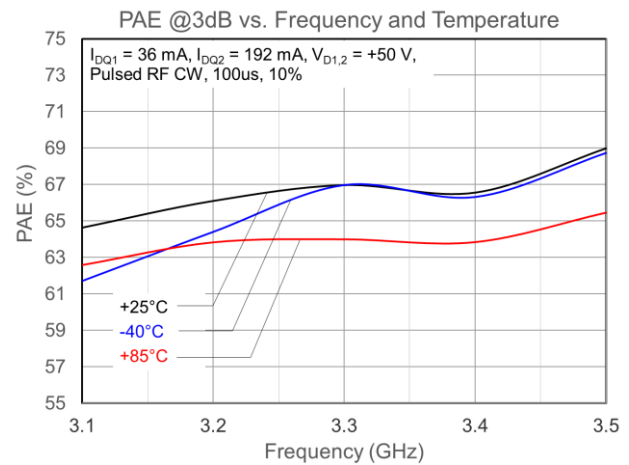
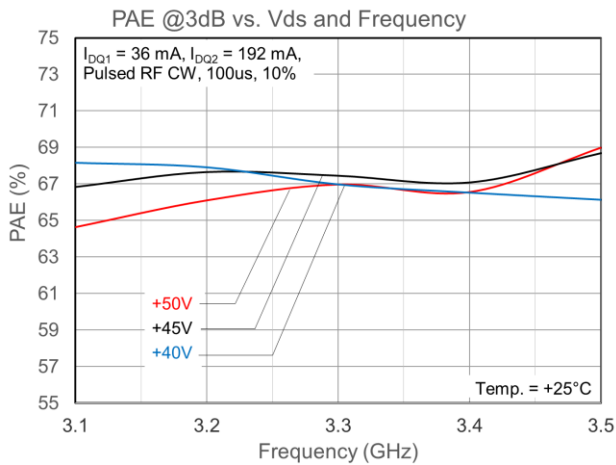
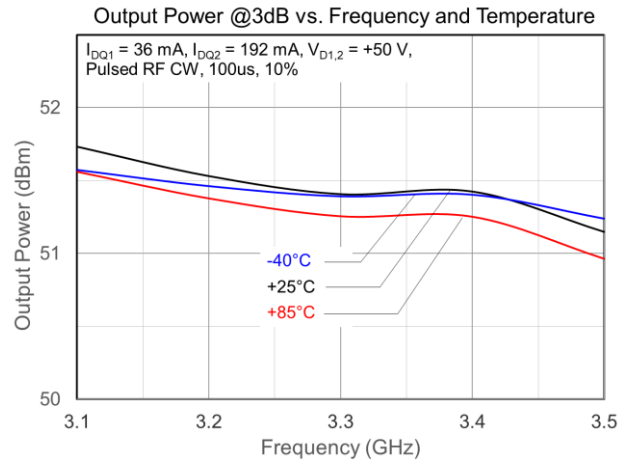
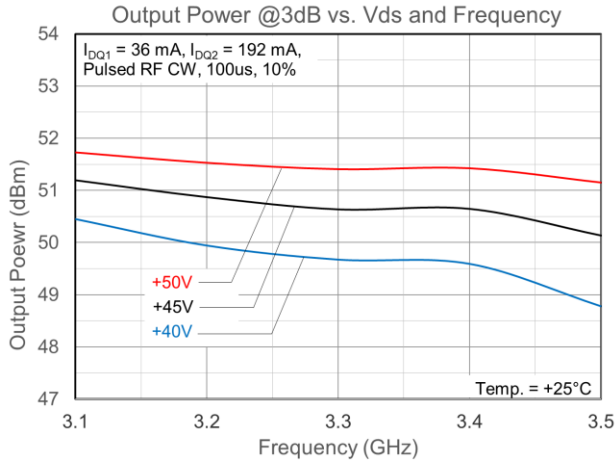

QPA2513 Typical Performance – S-Parameters

Notes: See page 8 for EVB reference planes where S-Parameters were measured.

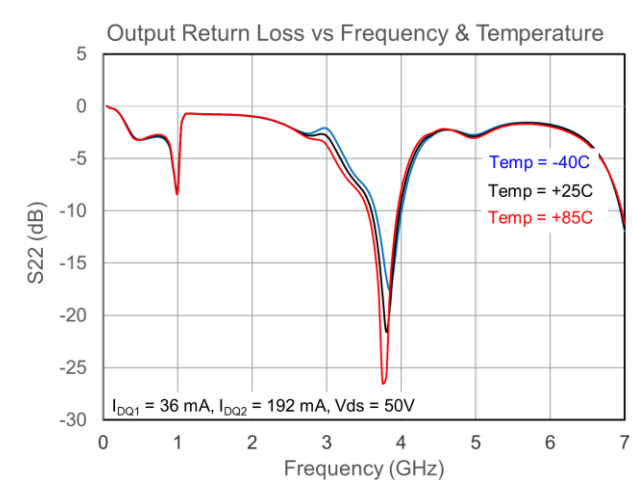
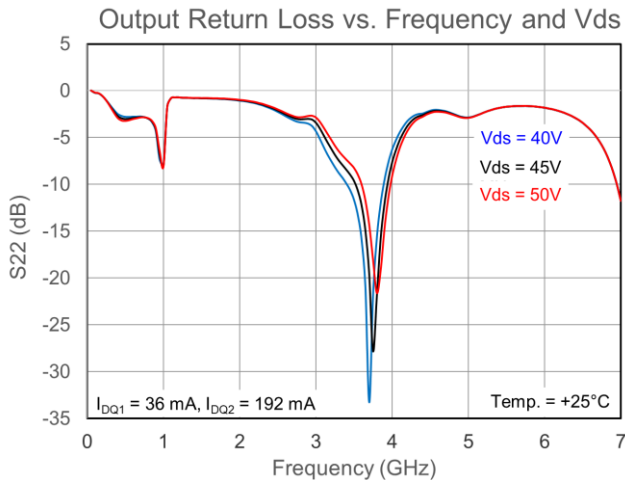
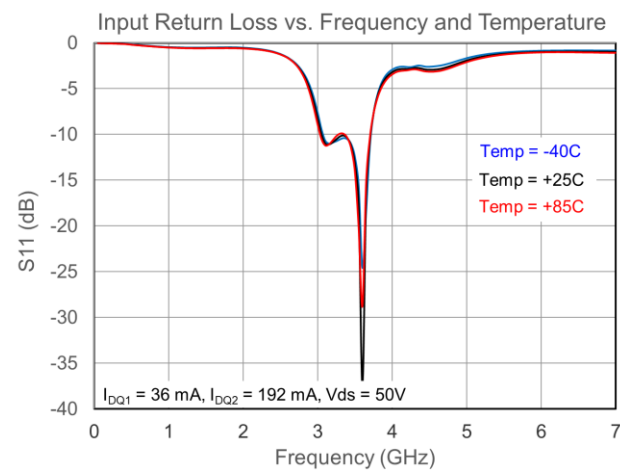
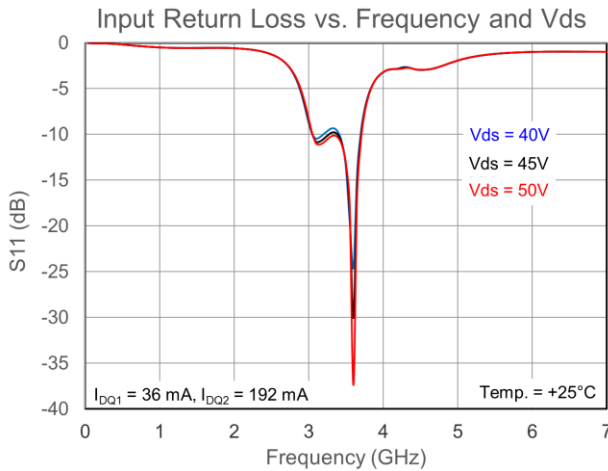
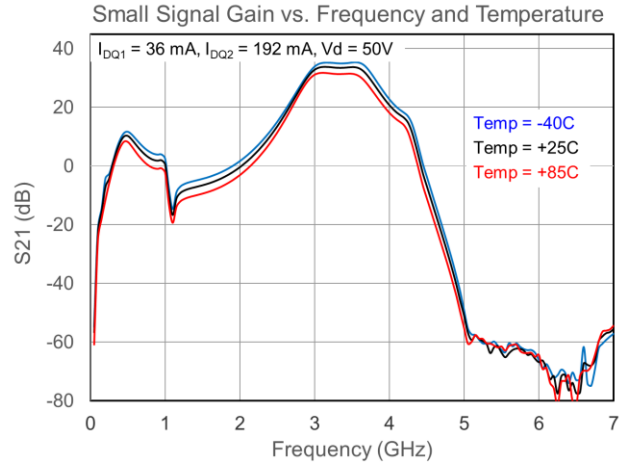
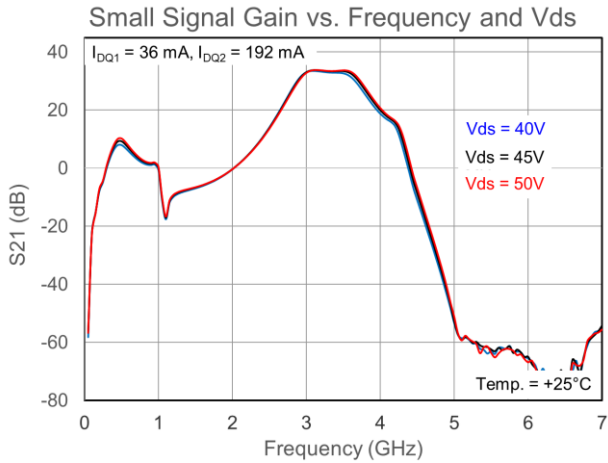

QPA2513 Evaluation Board Schematic

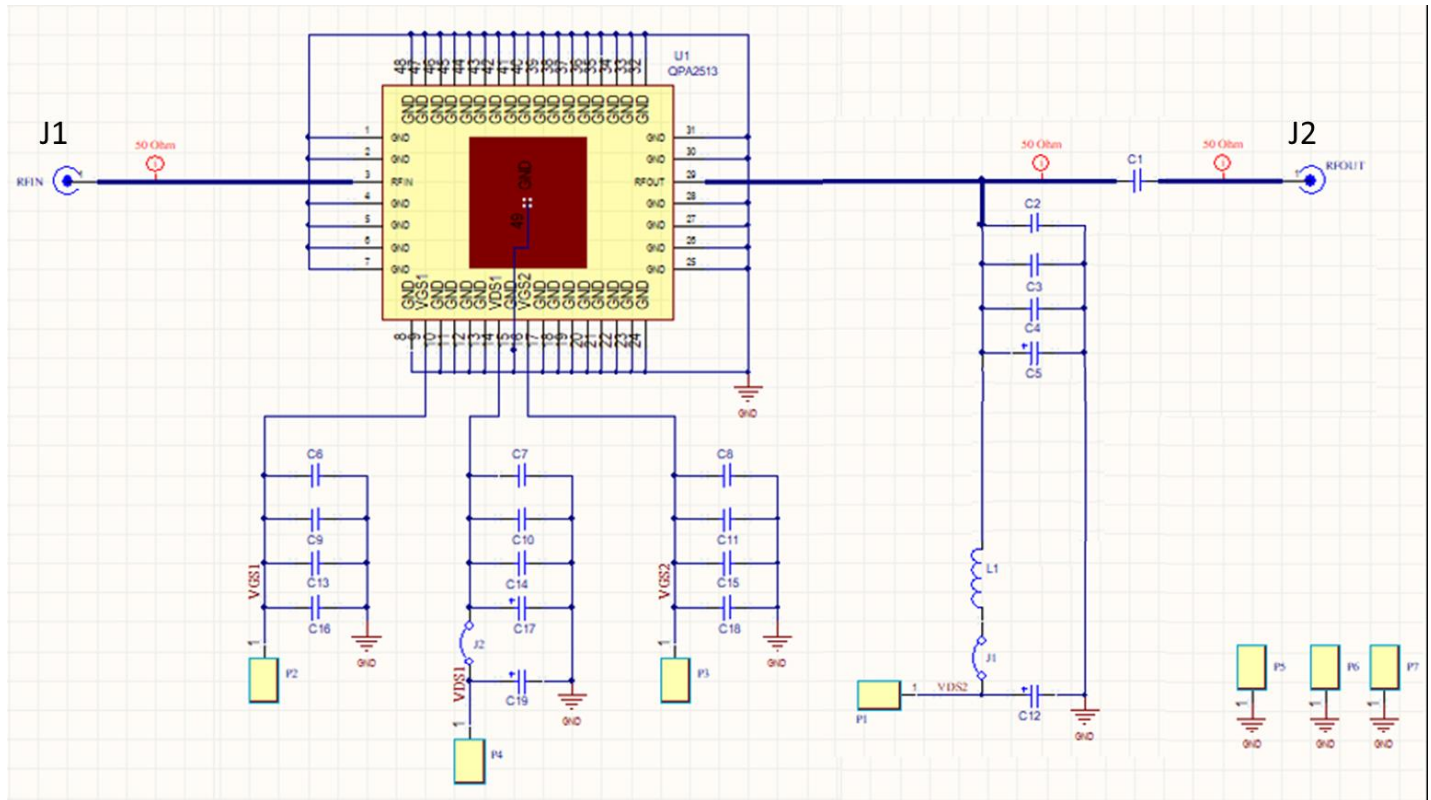

Notes:

Bill of Materials

Reference Des.	Value	Description	Manuf.	Part Number
C1	15 pF	Capacitor, 15pF, +/-5%, 250V, HI-Q, 0603	ATC	600S150JT250XT
C2, C6, C7, C8	12 pF	Capacitor, 12pF, 5%, 250V, HI-Q, 0805	ATC	600F120JT250XT
C3, C9, C10, C11	1000 pF	Capacitor, 1000pF, 10%, 500V, X7R, 1206	Samsung	CL31B102KGFNFNE
C4, C13, C14, C15	0.1 uF	Capacitor, 0.1uF, 10%, 100V, 1210	Murata	GRM32NR72A104KA01L
C5, C17	10 uF	Capacitor, 10uF, 20%, 100V, AL ELEC, AX	Panasonic	UCZ2A221MNQ1MS
C12, C19	220 uF	Capacitor, 220uF, 20%, 100V, ALU-ELECT, SMD	CDE	AFK227M2AR44T-F
C16, C18	10 uF	Capacitor, 10uF, 10%, 16V, X7R, 1210	TDK	C3225X7R1C106K200AB
L1	50 Ω	Ferrite, Bead, 115 Ohm, 10A, SMD	Laird Technology	28F0181-1SR-10
-	-	PCB QPA2513EVB	Various	-
J1, J2	-	Connector 50Ohm, SMA	Powell Electronics	PSF-S00-000
U1	-	100W 50V 3.1-3.5GHz GaN PA EHS	Qorvo	QPA2513

QPA2513 Evaluation Board Layout and Stencil

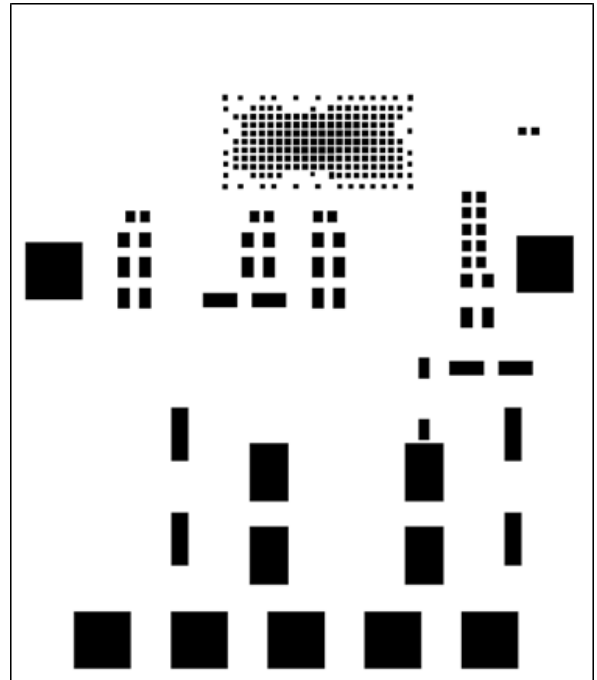
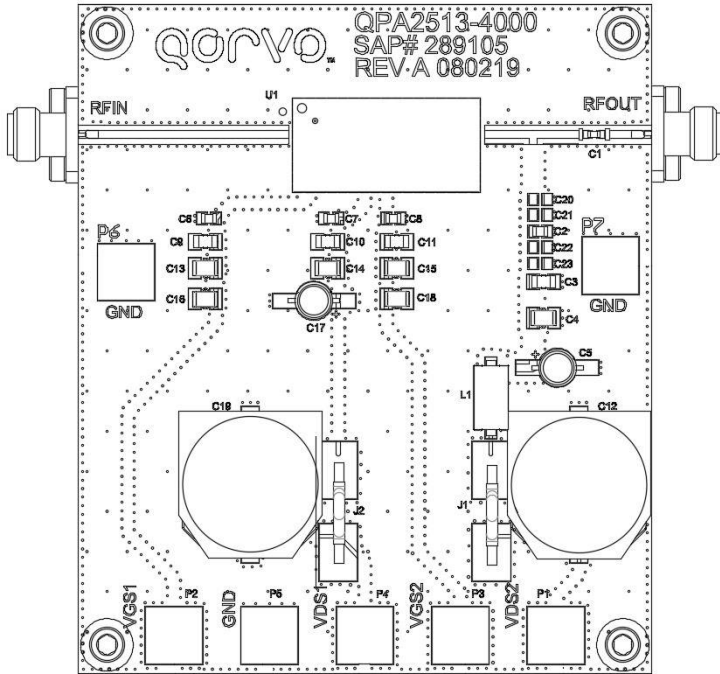

Notes:

1. PCB Rogers 4350B 0.020in, 2 Layers, Copper 1.0oz. (2 oz Finish Thickness)
2. Stencil thickness 0.006" [150 um]

QPA2513 Evaluation Board Reference Plane for S-Parameters

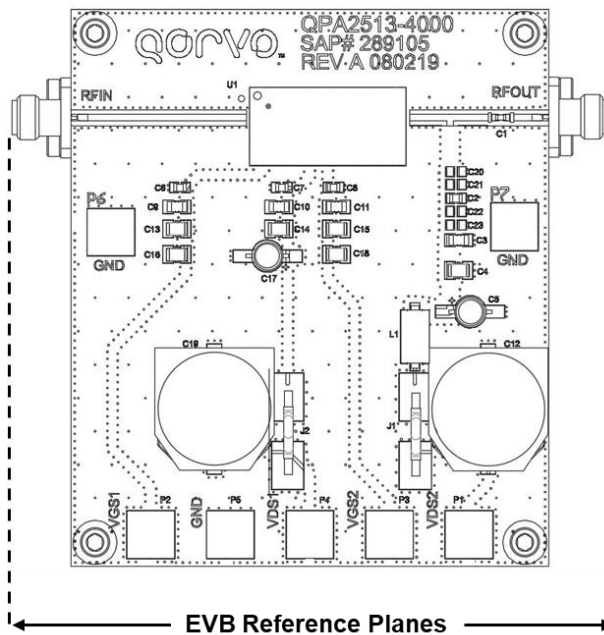

Notes:

Package Marking and Dimensions

Marking: Qorvo Logo
 QPA2513 – Part Number
 YY – Part Assembly Year
 WW - Part Assembly Week
 MXXX – Lot Number

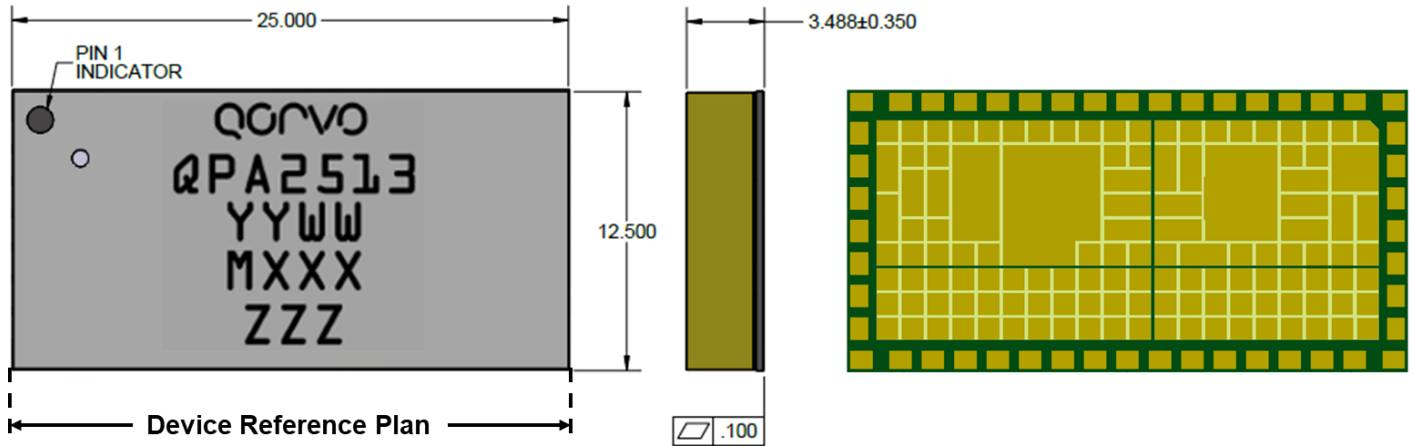

REMOVED BOTTOM SOLDERMASK TO SHOW BOTTOM METALLIZATION

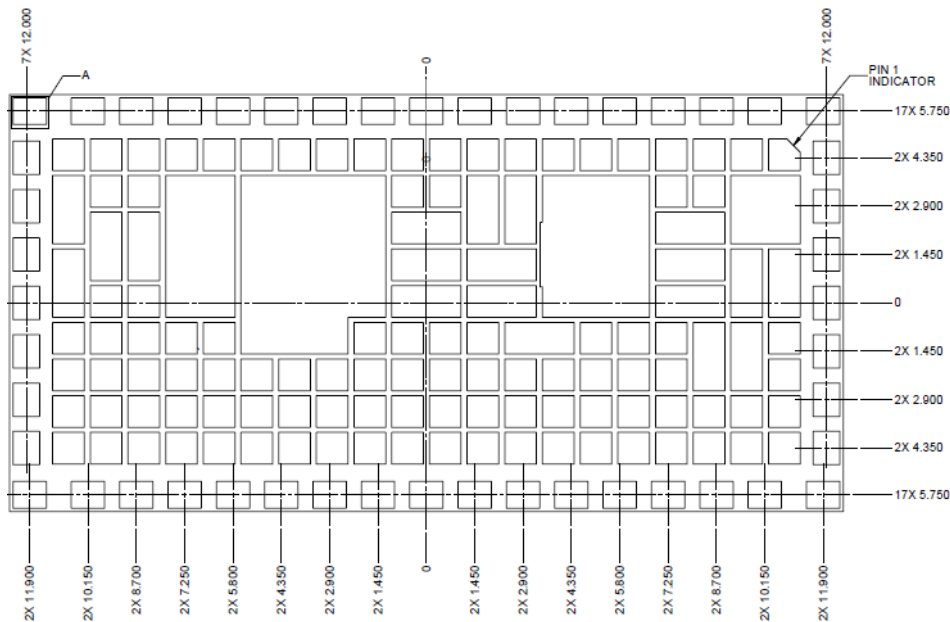

Notes:

1. All dimensions are in millimeters. Angles are in degrees.
2. General tolerance is ± 0.05 unless otherwise noted.
3. Package Base: Laminate
4. Package Lid: FR-4.
5. Contact plating: Au, Thickness is 0.1 μm MIN.

Pin Configuration and Description

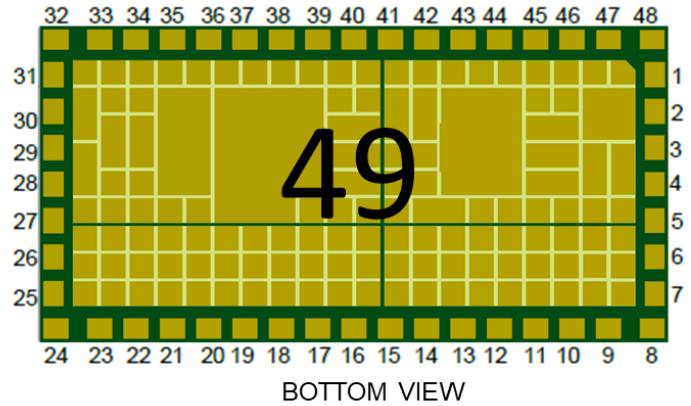
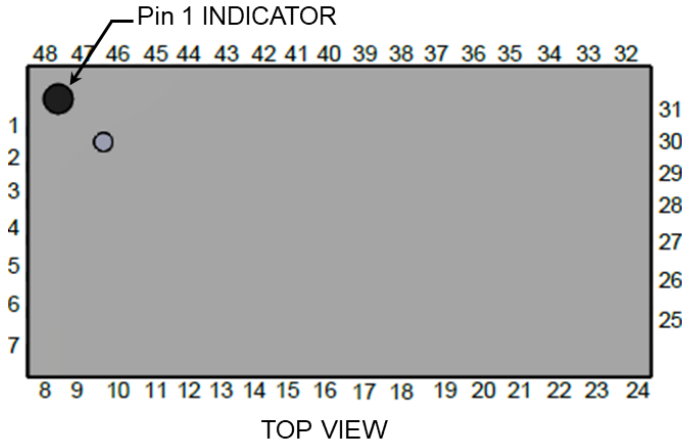

Pin Number	Label	Description
1, 2	GND	RF/DC ground.
3	RF IN	RF input
4, 5, 6, 7, 8	GND	RF/DC ground.
9	V _{GS1}	Driver Stage Gate Bias
10, 11, 12, 13	GND	RF/DC ground.
14	V _{DS1}	Driver Stage Drain Bias
15	GND	RF/DC ground.
16	V _{GS2}	Output Stage Gate Bias
17, 18, 19, 20, 21, 22, 23, 24, 25, 26, 27, 28	GND	RF/DC ground.
29	RF OUT, V _{DS2}	RF output, Output Stage Drain Bias
30, 31, 32, 33, 34, 35, 36, 37, 38, 39, 40, 41, 42, 43, 44, 45, 46, 47, 48	GND	RF/DC ground.
49 (Backside Paddle)	GND	RF/DC ground.

Power Amplifier Module Biasing Procedure

Bias On	Bias Off
<ol style="list-style-type: none"> Turn ON V_{GS1} to -5 V. Turn ON V_{GS2} to -5 V. Turn ON V_{DS1} and V_{DS2} to +50 V. Slowly adjust V_{GS1} until I_{DQ1} = 36 mA. (Typically, V_{G1} = -2.7 V.) Slowly adjust V_{GS2} until I_{DQ2} = 192 mA. (Typically, V_{G1} = -2.7 V.) Turn ON RF. 	<ol style="list-style-type: none"> Turn OFF RF. Adjust V_{GS1} and V_{GS2} to -5 V. Turn OFF V_{DS1} and V_{DS2}. Wait two (2) seconds to allow drain capacitors to discharge. Turn OFF V_{GS1} and V_{GS2}.

Tape and Reel Information – Carrier and Cover Tape Dimensions

Tape and reel specifications for this part are also available on the Qorvo website.
 Standard T/R size = 2500 pieces on a 13” reel.

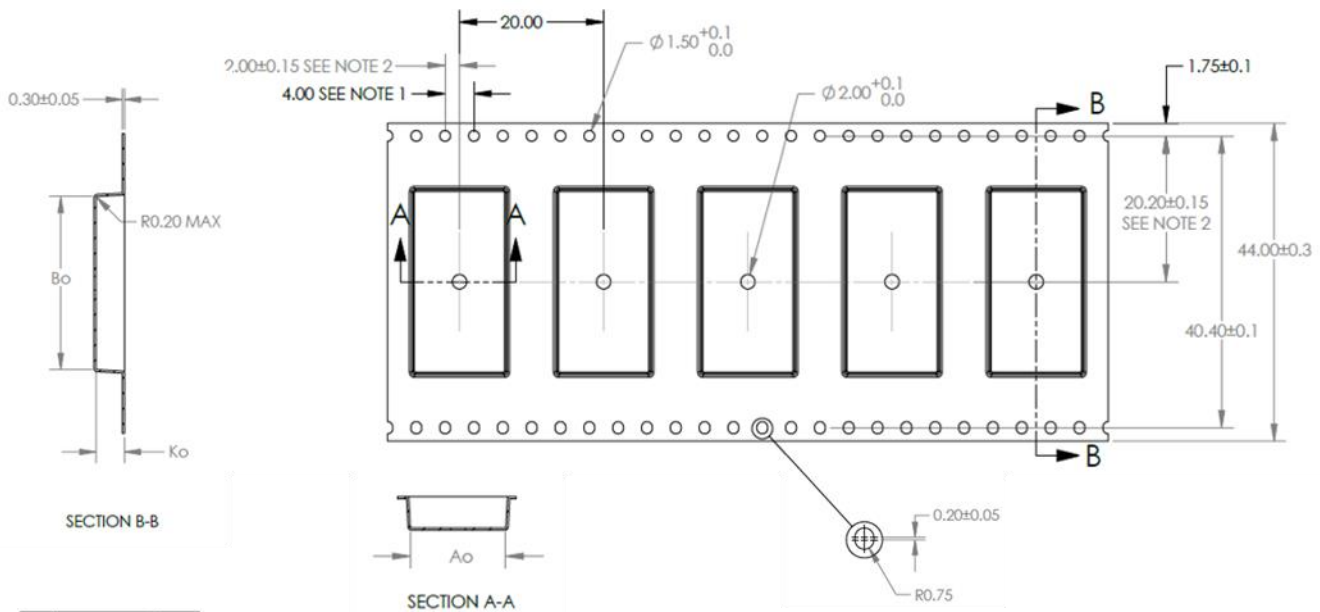
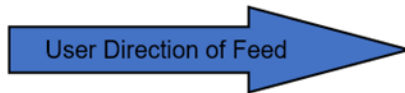
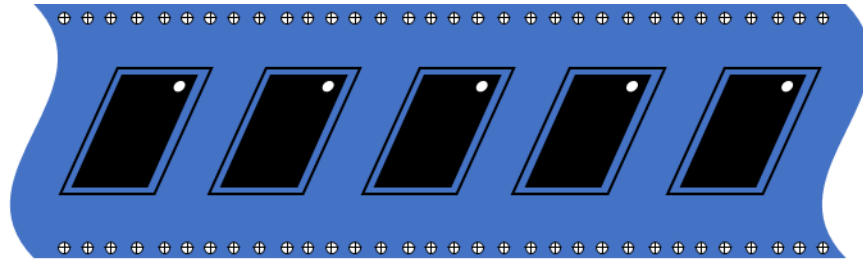

	DIM	±
Ao	12.90	0.10
Bo	25.40	0.10
Ko	4.20	0.10

- NOTES:**
1. 10 SPROCKET HOLE PITCH CUMULATIVE TOLERANCE ± 0.2
 2. POCKET POSITION RELATIVE TO SPROCKET HOLE MEASURED AS TRUE POSITION OF POCKET, NOT POCKET HOLE.
 3. Ao AND Bo ARE MEASURED ON A PLANE AT A DISTANCE "R" ABOVE THE BOTTOM OF THE POCKET.

Feature	Measure	Symbol	Size (in)	Size (mm)
Cavity	Length	A0	0.508	12.9
	Width	B0	1.000	25.4
	Depth	K0	0.165	4.23
	Pitch	P1	0.472	12.0
Centerline Distance	Cavity to Perforation - Length Direction	P2	0.079	2.0
	Cavity to Perforation - Width Direction	F	0.795	20.2
Cover Tape	Width	C	1.476	37.5
Carrier Tape	Width	W	1.732	44.0

Tape and Reel Information – Reel Dimensions

Packaging reels are used to prevent damage to devices during shipping and storage, loaded carrier tape is typically wound onto a plastic take-up reel. The reel size is 13" diameter. The reels are made from high-impact injection-molded polystyrene (HIPS), which offers mechanical and ESD protection to packaged devices.

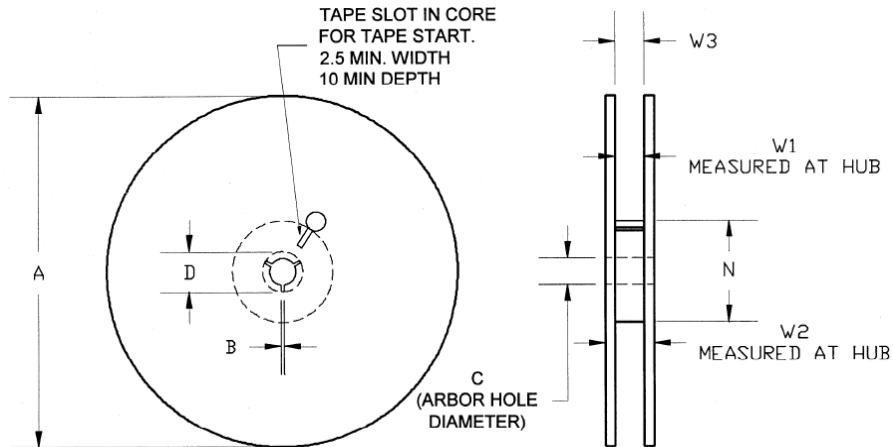

Feature	Measure	Symbol	Size (in)	Size (mm)
Flange	Diameter	A	12.992	330.0
	Thickness	W2	1.976	50.2
	Space Between Flange	W1	1.764	44.8
Hub	Outer Diameter	N	4.016	102.0
	Arbor Hole Diameter	C	0.512	13.0
	Key Slit Width	B	0.079	2.0
	Key Slit Diameter	D	0.787	20.0

Recommended Solder Temperature Profile

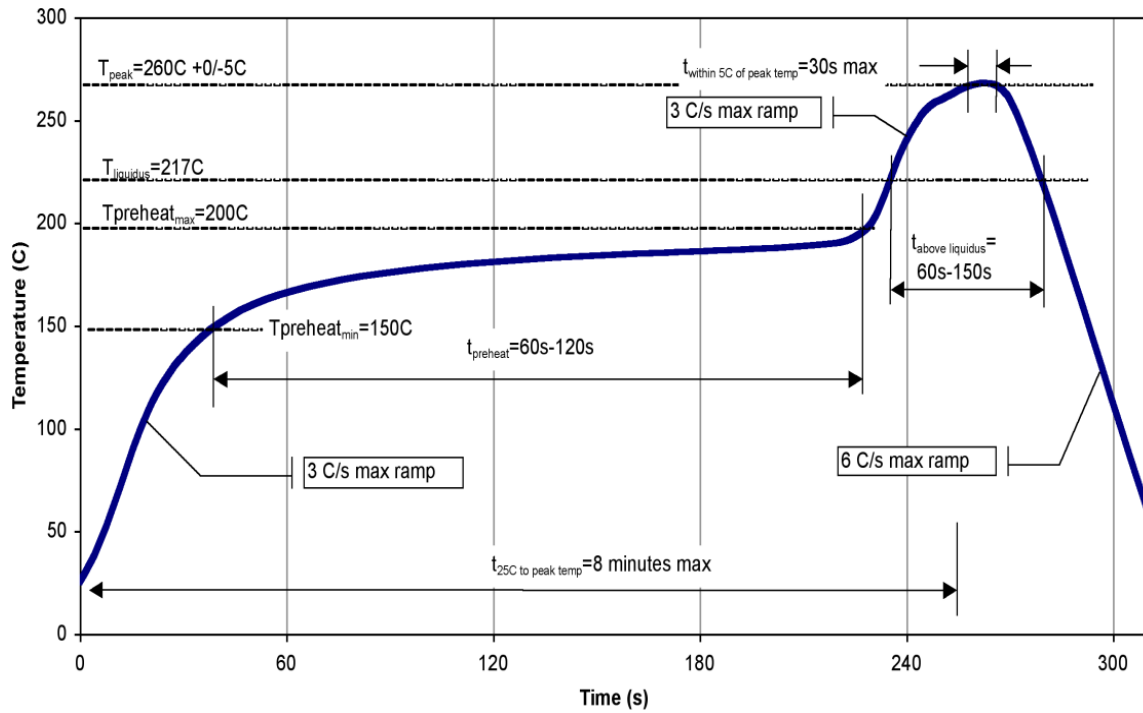

Handling Precautions

Parameter	Rating	Standard
ESD – Human Body Model (HBM)	Class 1A	ANSI/ESDA/JEDEC Standard JS-001
ESD – Charged Device Model (CDM)	Class C3	ANSI/ESDA/JEDEC Standard JS-002
MSL – Moisture Sensitivity Level	MSL3	IPC/JEDEC Standard J-STD-020



Solderability

Compatible with lead-free (260°C max. reflow temp.) soldering process.

This package is air-cavity and non-hermetic, and therefore cannot be subjected to aqueous washing. The use of no-clean solder to avoid washing after soldering is highly recommended.

Package lead plating is ENEPIG.

Solder rework not recommended

RoHS Compliance

This part is compliant with 2011/65/EU RoHS directive (Restrictions on the Use of Certain Hazardous Substances in Electrical and Electronic Equipment) as amended by Directive 2015/863/EU.

This product also has the following attributes:

- Antimony Free
- TBBP-A (C₁₅H₁₂Br₄O₂) Free
- PFOS Free
- SVHC Free

Contact Information

For the latest specifications, additional product information, worldwide sales and distribution locations:

Web: www.qorvo.com

Tel: 1-844-890-8163

Email: customer.support@qorvo.com

Important Notice

The information contained herein is believed to be reliable; however, Qorvo makes no warranties regarding the information contained herein and assumes no responsibility or liability whatsoever for the use of the information contained herein. All information contained herein is subject to change without notice. Customers should obtain and verify the latest relevant information before placing orders for Qorvo products. The information contained herein or any use of such information does not grant, explicitly or implicitly, to any party any patent rights, licenses, or any other intellectual property rights, whether with regard to such information itself or anything described by such information. **THIS INFORMATION DOES NOT CONSTITUTE A WARRANTY WITH RESPECT TO THE PRODUCTS DESCRIBED HEREIN, AND QORVO HEREBY DISCLAIMS ANY AND ALL WARRANTIES WITH RESPECT TO SUCH PRODUCTS WHETHER EXPRESS OR IMPLIED BY LAW, COURSE OF DEALING, COURSE OF PERFORMANCE, USAGE OF TRADE OR OTHERWISE, INCLUDING THE IMPLIED WARRANTIES OF MERCHANTABILITY AND FITNESS FOR A PARTICULAR PURPOSE.**

Without limiting the generality of the foregoing, Qorvo products are not warranted or authorized for use as critical components in medical, life-saving, or life-sustaining applications, or other applications where a failure would reasonably be expected to cause severe personal injury or death.

Copyright 2020 © Qorvo, Inc. | Qorvo is a registered trademark of Qorvo, Inc.

Mouser Electronics

Authorized Distributor

Click to View Pricing, Inventory, Delivery & Lifecycle Information:

Qorvo:

[QPA2513](#) [QPA2513EVB04](#)