

Product Overview

Qorvo’s QPA2225D is a wide band MMIC driver amplifier fabricated on Qorvo’s production 0.15 um GaN on SiC process (QGaN15). Covering 28–38 GHz, the QPA2225D provides > 0.4 W of saturated output power with >23 dB of small-signal gain.

The QPA2225D MMIC dimensions are 1.65 x 0.67 x 0.05 mm. It can support a variety of operating conditions to best support system requirements. With good thermal properties, it can support a range of bias voltages.

The QPA2225D has DC blocking capacitors on both RF ports, which are matched to 50 ohms.

The QPA2225D is ideal for supporting communications and radar applications in both commercial and military markets.

Lead-free and RoHS compliant.

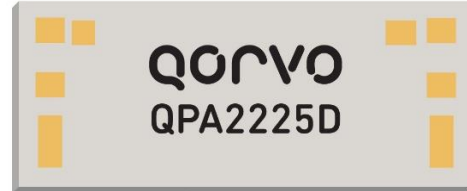

Key Features

- Frequency Range: 28 – 38 GHz
- P_{SAT} (P_{IN} = 13 dBm): > 26 dBm
- Small Signal Gain: > 23 dB
- IM3 (P_{OUT}/Tone = 20 dBm): -20 dBc
- Bias: CW, V_D = +20 V, I_{DQ} = 64 mA, V_G = -2.5 V typ.
- Die Dimensions: 1.65 x 0.67 x 0.05 mm

Performance is typical across frequency. Please reference electrical specification table and data plots for more details.

Functional Block Diagram

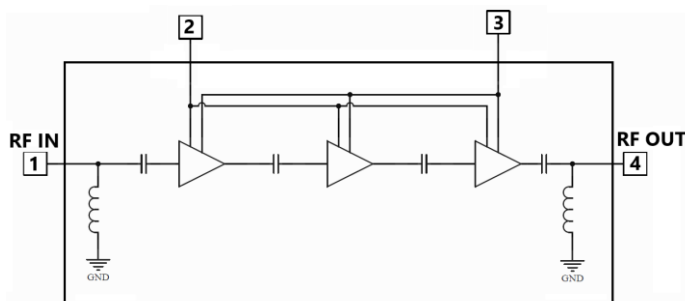

Applications

- Communications
- Radar
- Satellite Communications
- Electronic Warfare

Ordering Information

Part No.	Description
QPA2225D	28 – 38 GHz 0.4 Watt GaN Amplifier (100 pcs.)
QPA2225DS2	Samples (2 pcs. pack)
QPA2225DEVBA	Evaluation Board for QPA2225D

Absolute Maximum Ratings

Parameter	Value / Range
Drain Voltage (V_D)	29.5 V
Gate Voltage Range (V_G)	-6 V to 0 V
Drain Current (I_D)	456 mA
Gate Current (I_G)	See plot page 18
Power Dissipation (P_{DISS}), 85 °C	5 W
Input Power (P_{IN}), CW, 50 Ω , $V_D = 20$ V, $I_{DQ} = 64$ mA, $T_{BASE} = 85$ °C	18 dBm
Input Power (P_{IN}), CW, 3:1 VSWR, $V_D = 20$ V, $I_{DQ} = 64$ mA, $T_{BASE} = 85$ °C	18 dBm
Mounting Temperature (30 seconds)	320 °C
Storage Temperature	-55 to +150 °C

Operation of this device outside the parameter ranges given above may cause permanent damage. These are stress ratings only, and functional operation of the device at these conditions is not implied.

Recommended Operating Conditions

Parameter	Min	Typ.	Max	Units
Drain Voltage (V_D)		+20		V
Drain Current, (I_{DQ})		64		mA
Drain Current, RF (I_{D_Drive})	See chart page 6			mA
Gate Voltage Range (V_G)	-2 to -2.9			V
Gate Current, RF (I_{G_Drive})	See chart page 6			mA
T_{BASE} Range	-40		+85	°C

Electrical specifications are measured at specified test conditions. Specifications are not guaranteed over all recommended operating conditions.

Electrical Specifications

Parameter	Conditions ⁽¹⁾ ⁽²⁾	Min	Typ.	Max	Units
Operational Frequency Range		28		38	GHz
Output Power at Saturation, P_{SAT}	$P_{IN} = +13$ dBm		> 26		dBm
Large Signal Gain	$P_{IN} = +13$ dBm		> 13		dB
Small Signal Gain, S_{21}			> 23		dB
Input Return Loss, IRL			5		dB
Output Return Loss, ORL			5		dB
3 RD Intermodulation Products, IM3	$P_{OUT}/Tone = 20$ dBm; Freq. = 35 GHz; $\Delta f = 100$ MHz		-20		dBc
5 TH Intermodulation Products, IM5	$P_{OUT}/Tone = 20$ dBm; Freq. = 35 GHz; $\Delta f = 100$ MHz		-30		dBc
P_{SAT} Temperature Coefficient	$T_{DIFF} = -40$ °C to +85 °C; $P_{IN} = +13$ dBm		-0.02		dBm/°C
S_{21} Temperature Coefficient	$T_{DIFF} = -40$ °C to +85 °C		-0.07		dB/°C

Notes:

1. Test conditions unless otherwise noted: CW, $V_D = +20$ V, $I_{DQ} = 64$ mA, $V_G = -2.5$ V +/- typical, $T_{BASE} = +25$ °C, $Z_0 = 50$ Ω
2. T_{BASE} is back side of 20 mil CuMo carrier plate with AuSn solder

Performance Plots – Small Signal

Test conditions, unless otherwise noted: CW, $V_D = 20\text{ V}$, $I_{DQ} = 64\text{ mA}$, $T_{BASE} = +25\text{ }^\circ\text{C}$

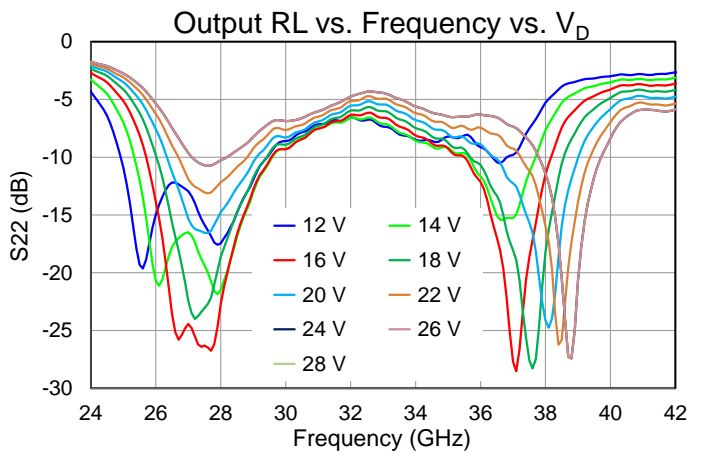
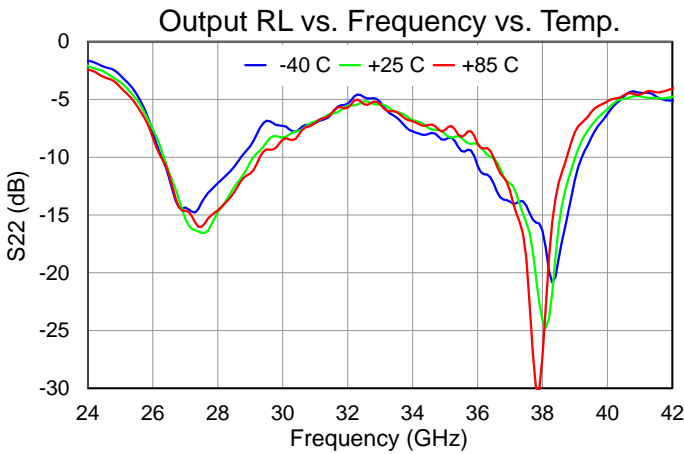
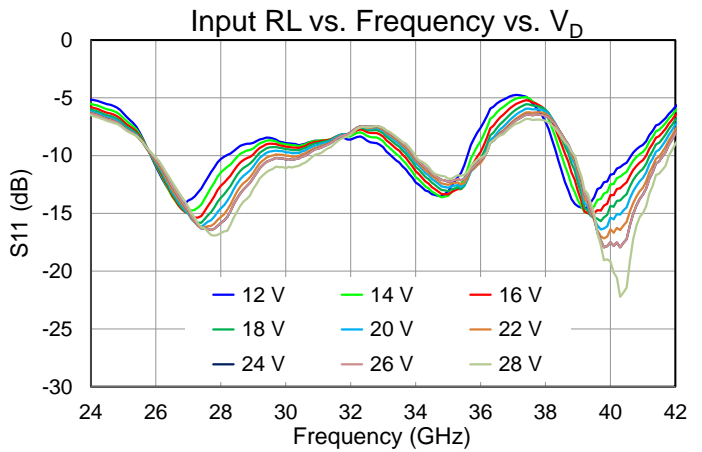
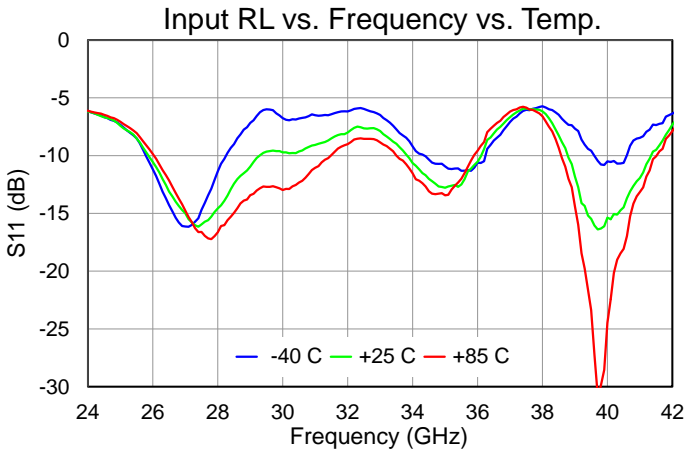
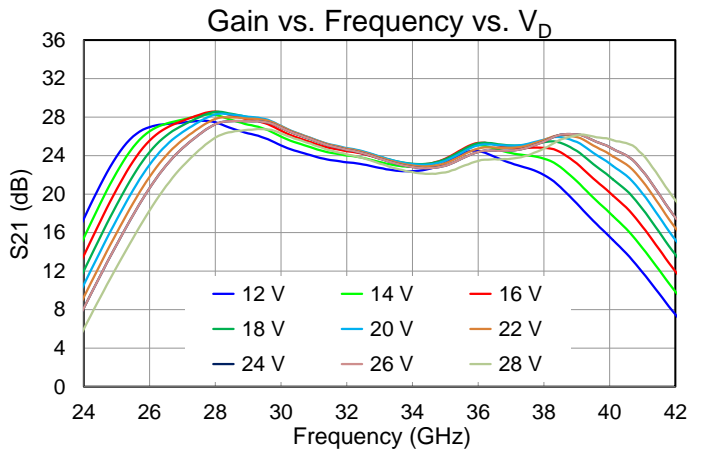
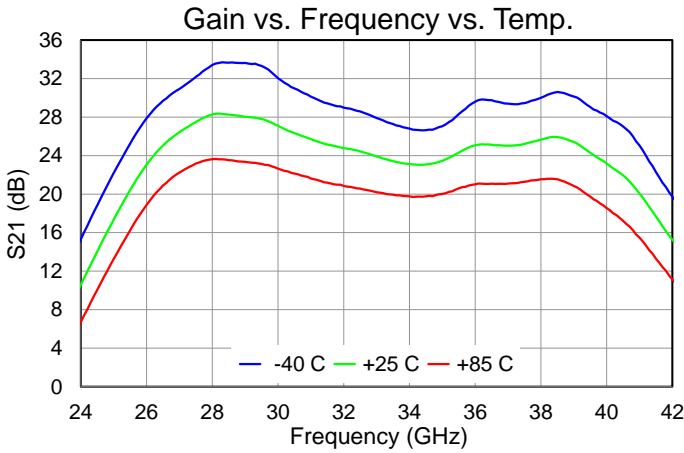

Performance Plots – Small Signal

Test conditions, unless otherwise noted: CW, $V_D = 20\text{ V}$, $I_{DQ} = 64\text{ mA}$, $T_{BASE} = +25\text{ }^\circ\text{C}$

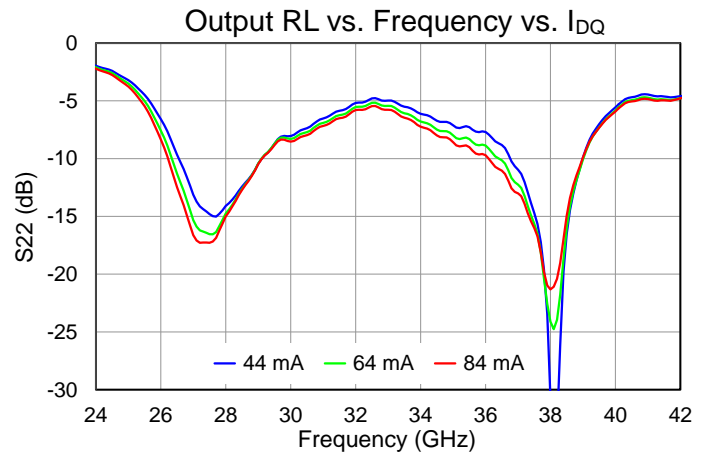
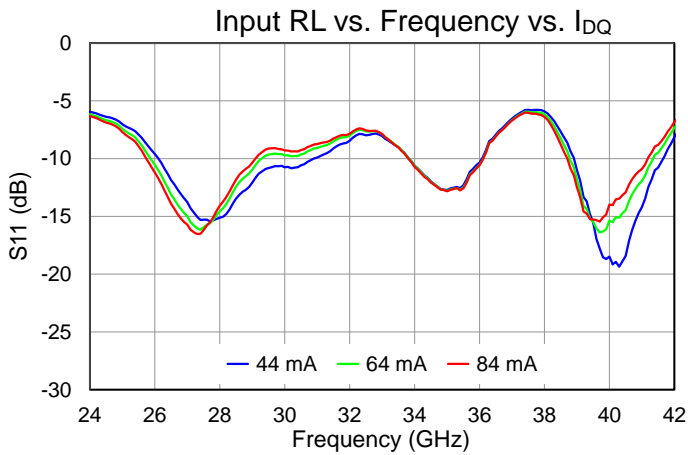
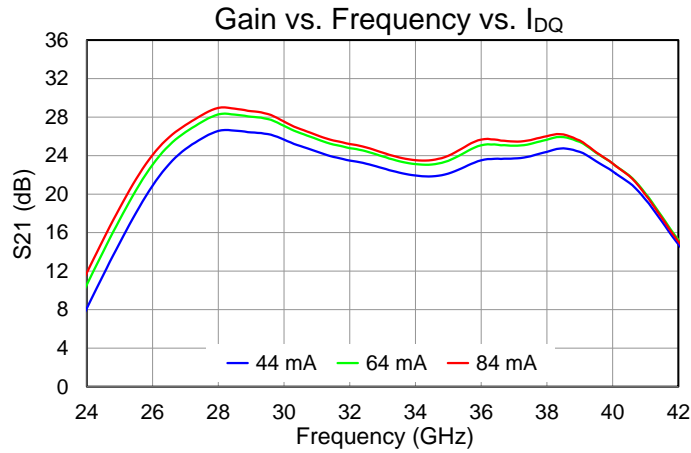

Performance Plots – Large Signal (CW)

Test conditions, unless otherwise noted: **CW**, $V_D = 20\text{ V}$, $I_{DQ} = 64\text{ mA}$, $P_{IN} = +13\text{dBm}$, $T_{BASE} = +25\text{ }^\circ\text{C}$

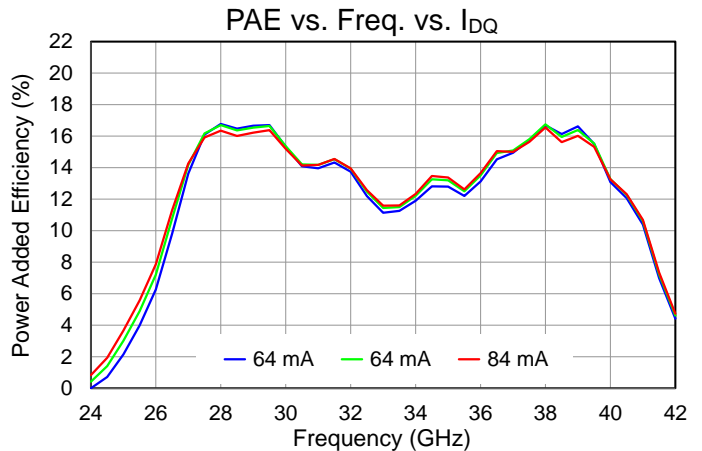
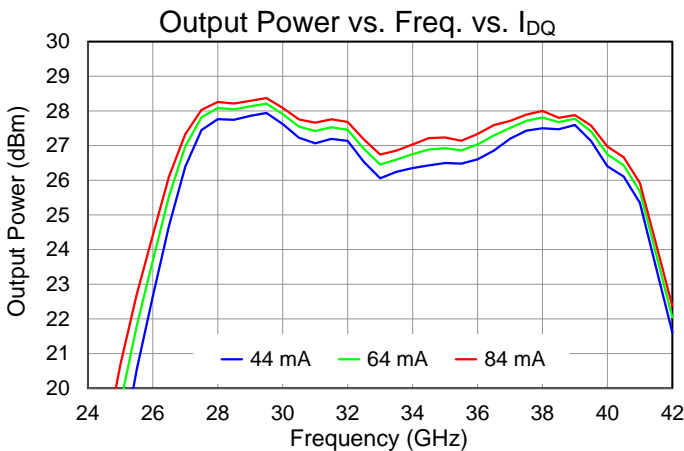
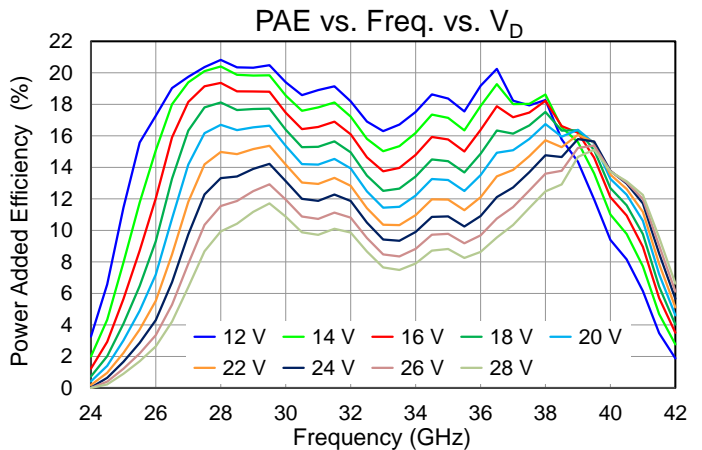
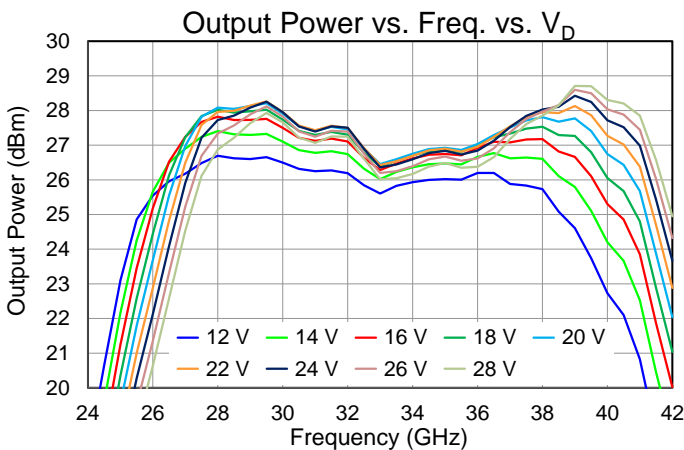
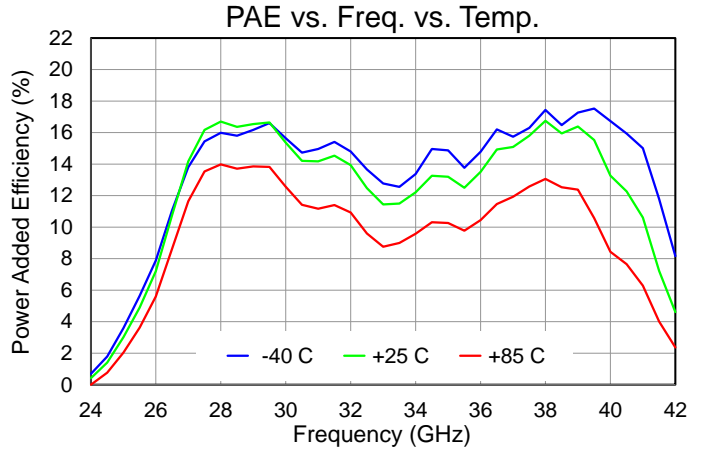
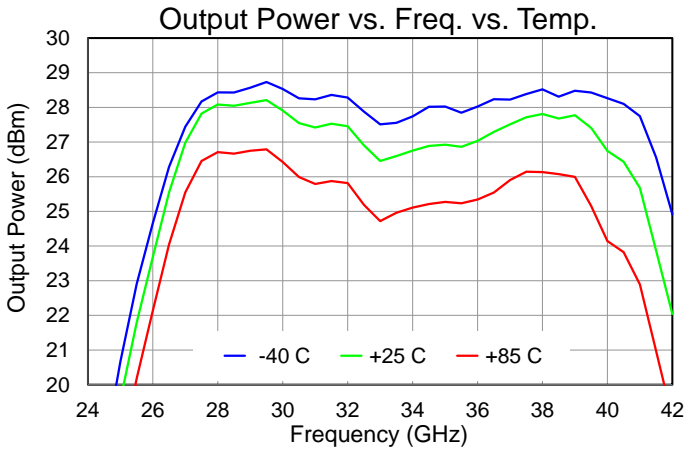

Performance Plots – Large Signal (CW)

Test conditions, unless otherwise noted: **CW**, $V_D = 20\text{ V}$, $I_{DQ} = 64\text{ mA}$, $P_{IN} = +13\text{dBm}$, $T_{BASE} = +25\text{ }^\circ\text{C}$

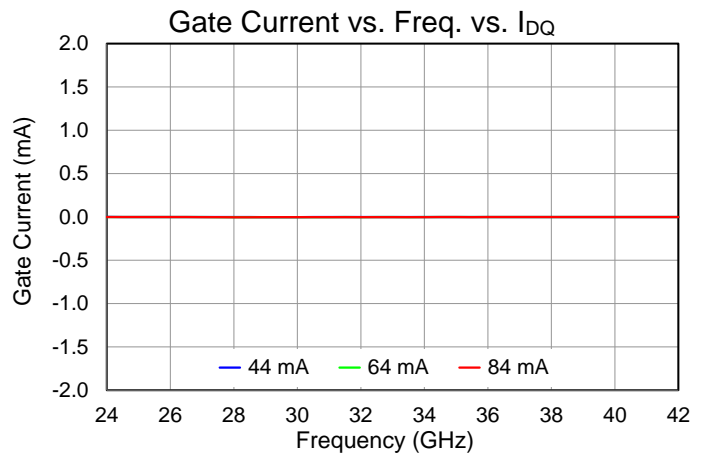
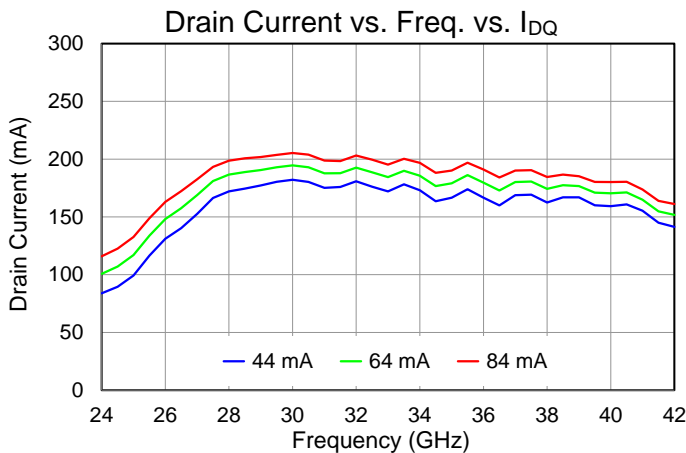
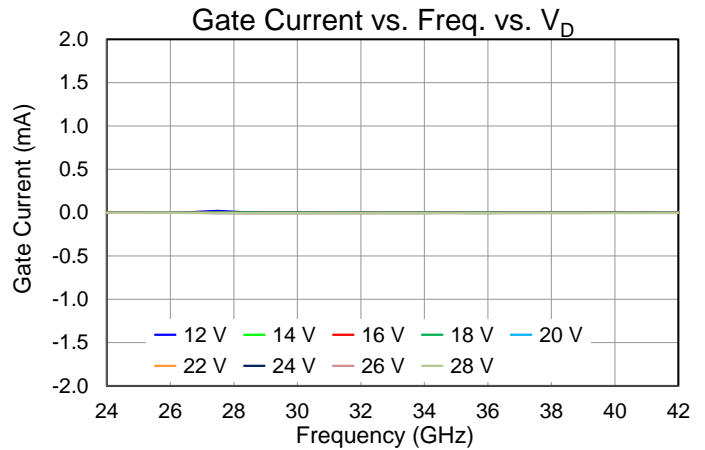
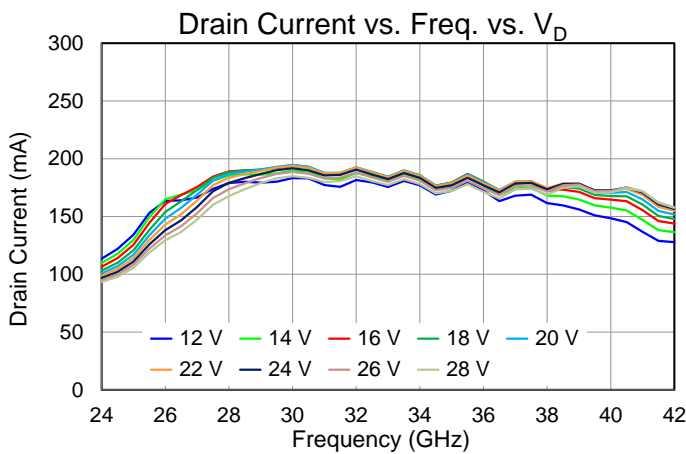
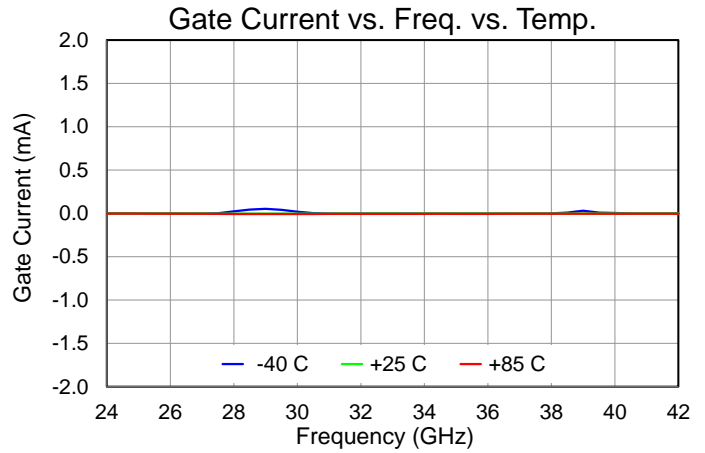
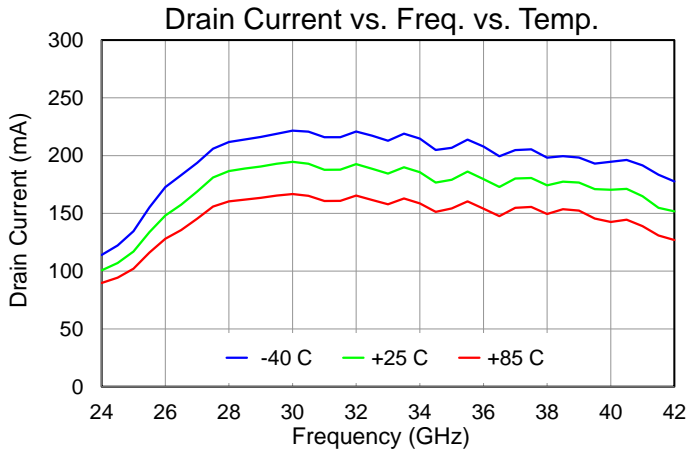

Performance Plots – Large Signal (CW)

Test conditions, unless otherwise noted: **CW**, $V_D = 20\text{ V}$, $I_{DQ} = 64\text{ mA}$, $P_{IN} = +13\text{ dBm}$, $T_{BASE} = +25\text{ }^\circ\text{C}$

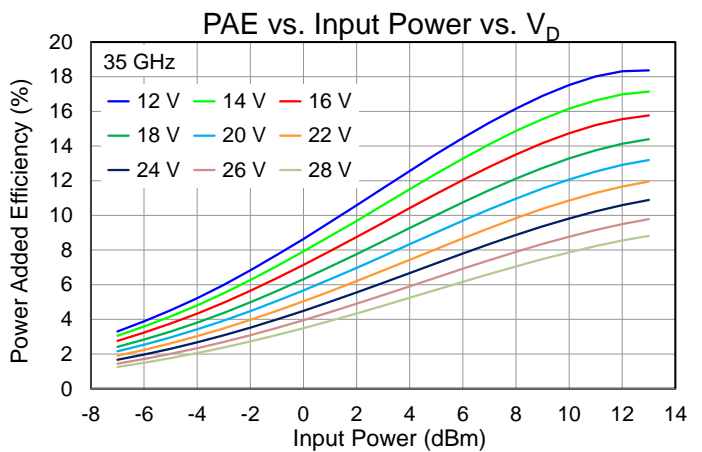
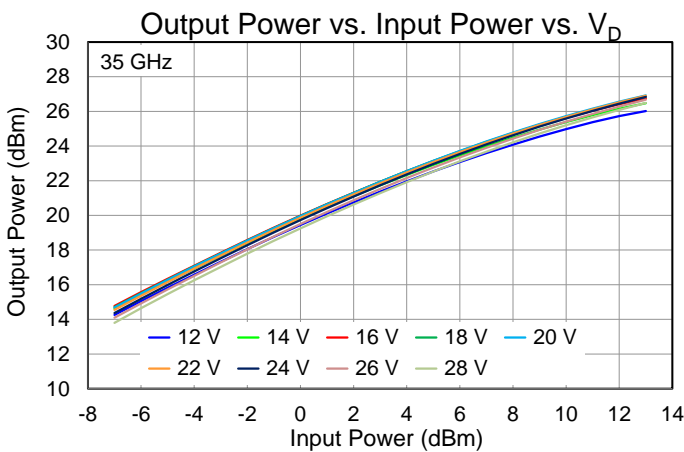
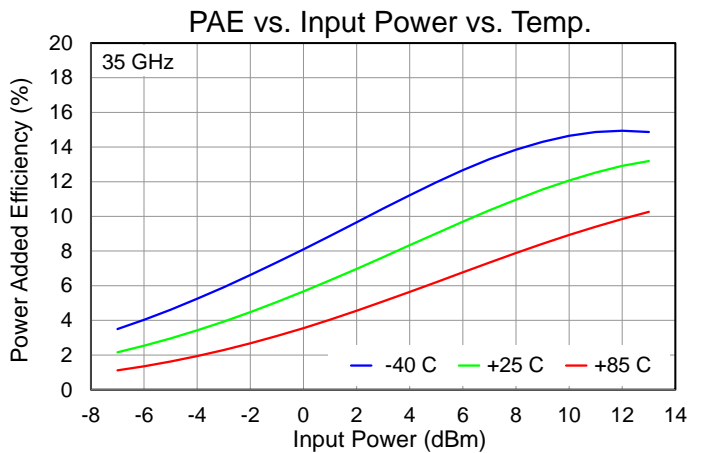
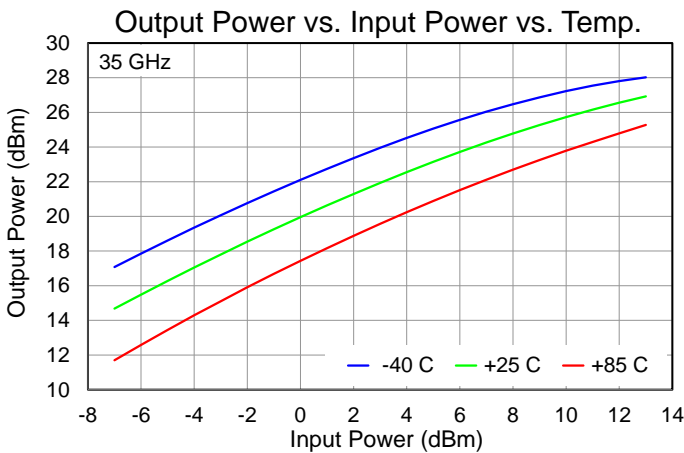
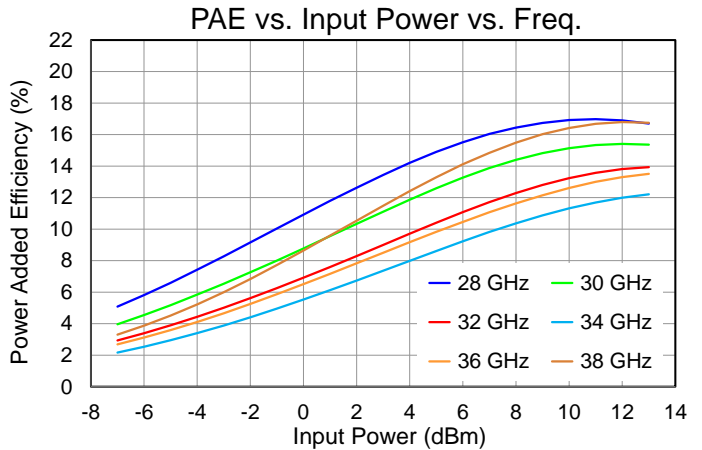
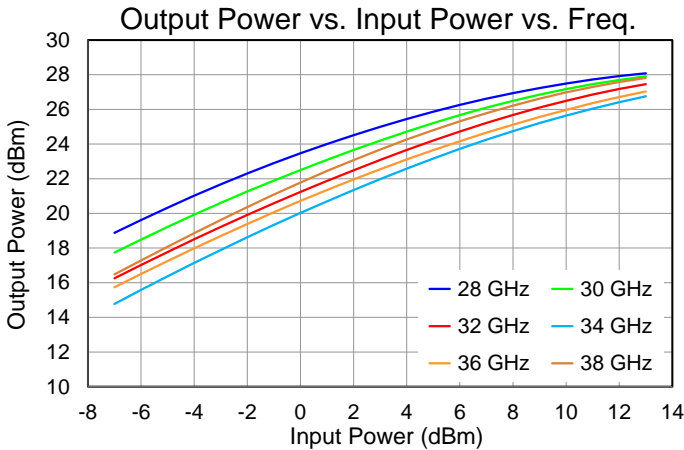

Performance Plots – Large Signal (CW)

Test conditions, unless otherwise noted: **CW**, $V_D = 20\text{ V}$, $I_{DQ} = 64\text{ mA}$, $P_{IN} = +13\text{ dBm}$, $T_{BASE} = +25\text{ }^\circ\text{C}$

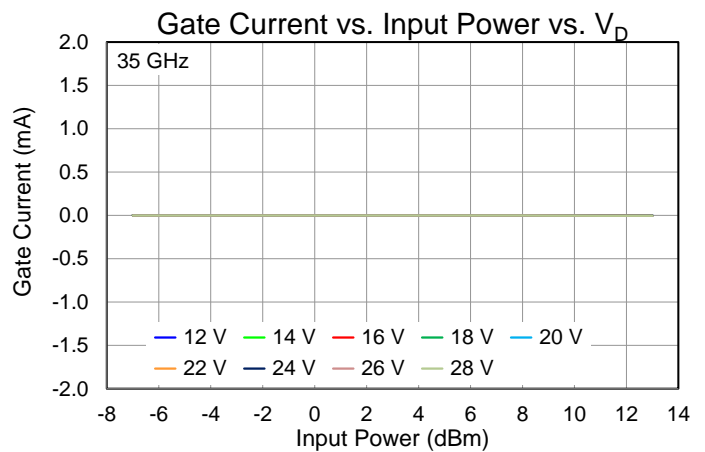
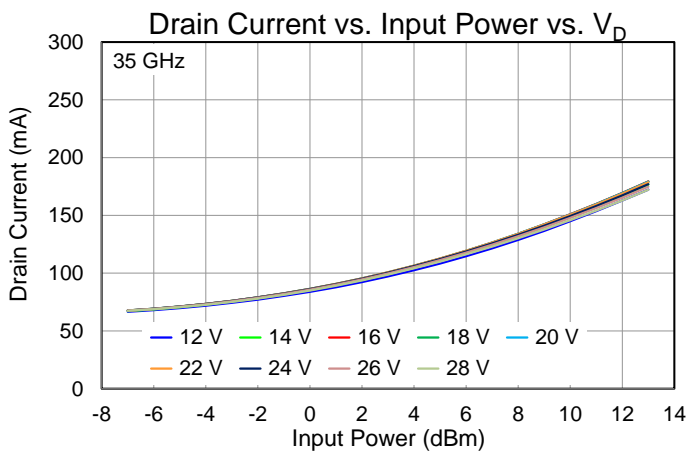
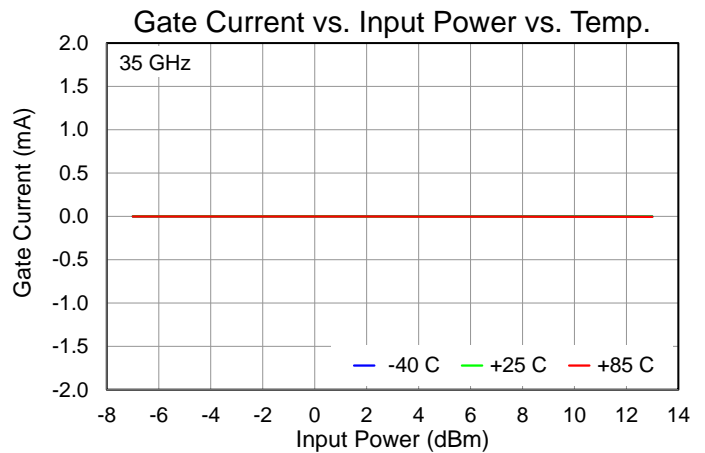
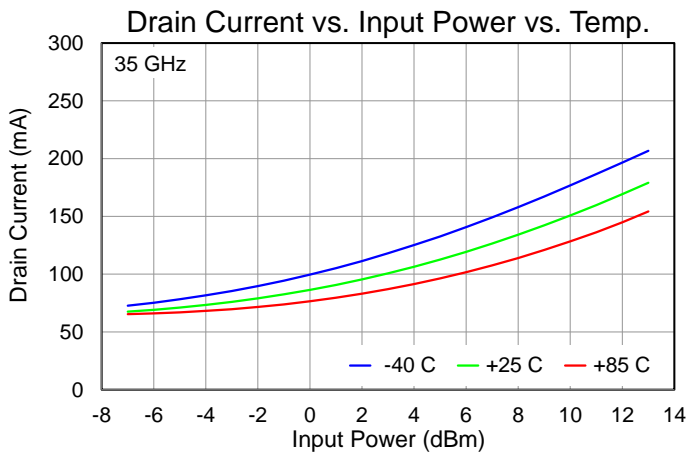
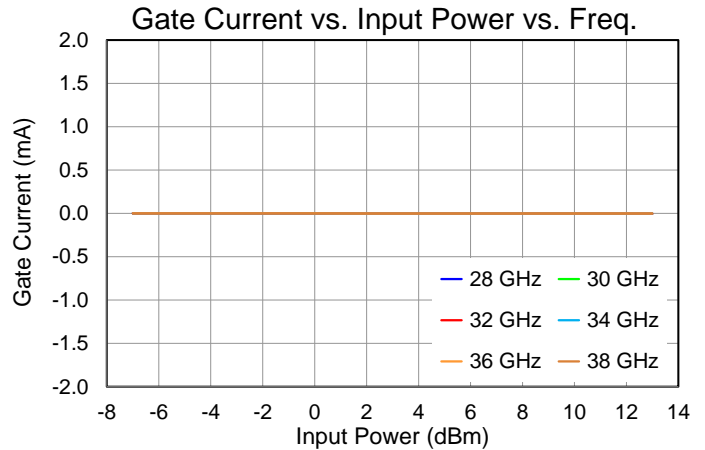
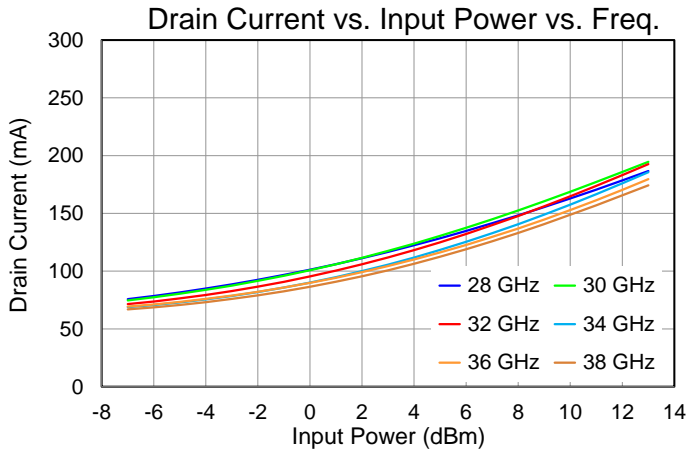

Performance Plots – Large Signal (CW)

Test conditions, unless otherwise noted: **CW**, $V_D = 20\text{ V}$, $I_{DQ} = 64\text{ mA}$, $P_{IN} = +13\text{ dBm}$, $T_{BASE} = +25\text{ }^\circ\text{C}$

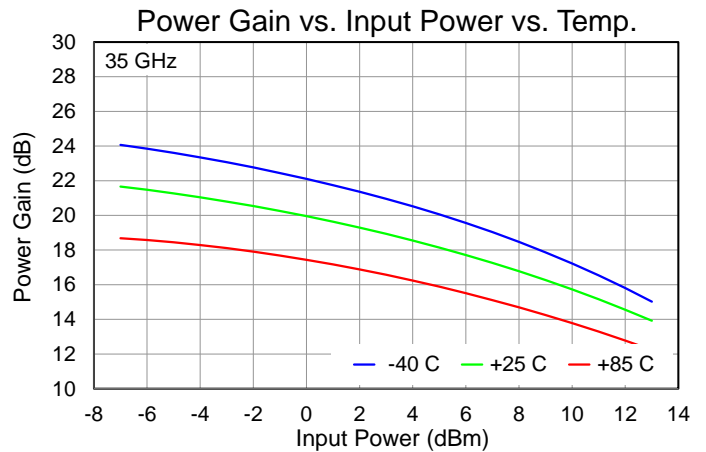
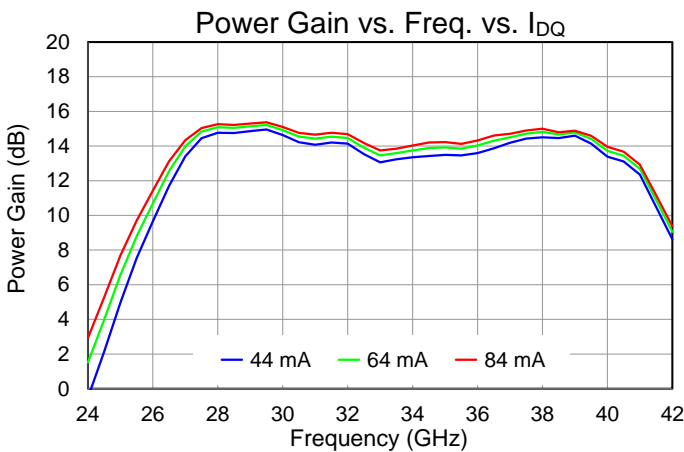
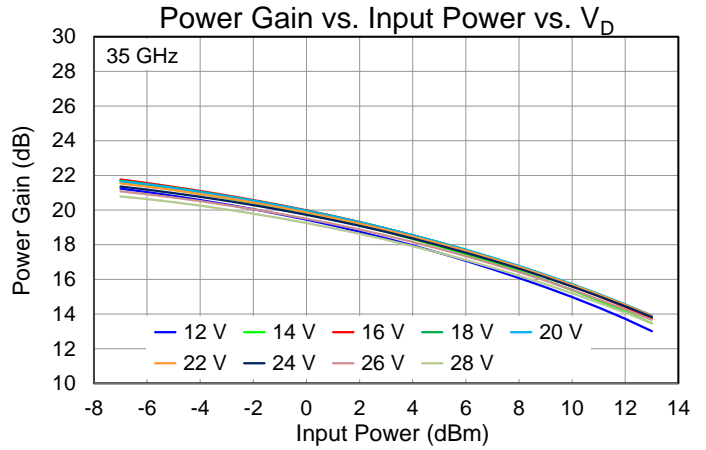
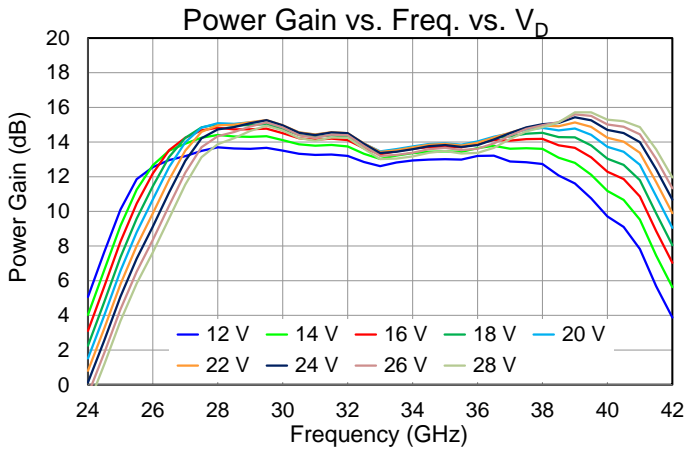
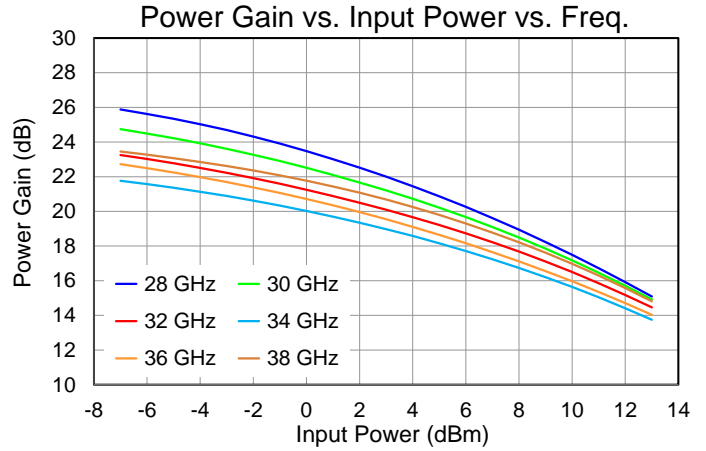
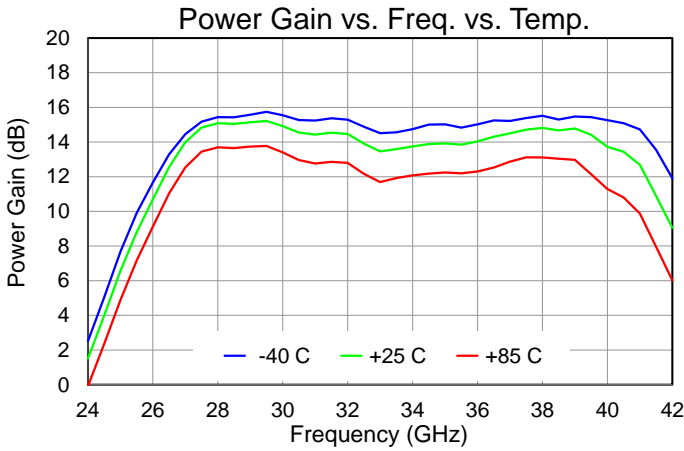

Performance Plots – Large Signal (Pulsed)

Test conditions, unless otherwise noted: **Pulsed** $V_D = 20\text{ V}$, $I_{DQ} = 64\text{ mA}$, $PW = 100\ \mu\text{s}$, $DC = 10\%$, $P_{IN} = +13\text{dBm}$, $T_{BASE} = +25\text{ }^\circ\text{C}$

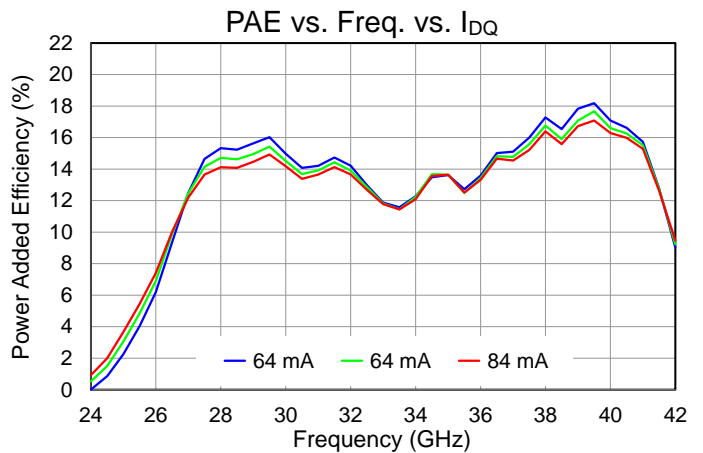
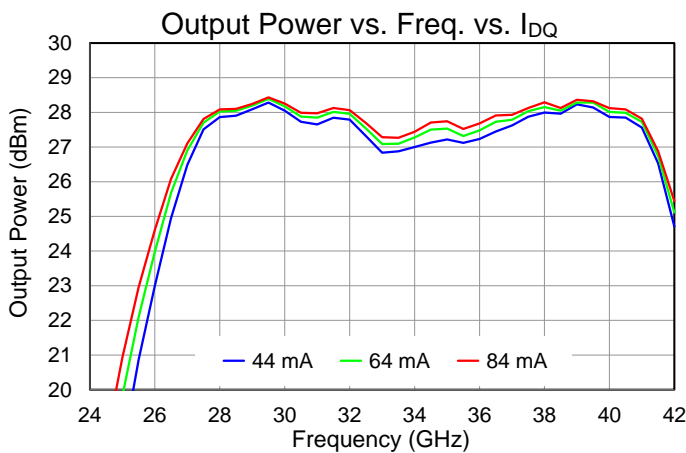
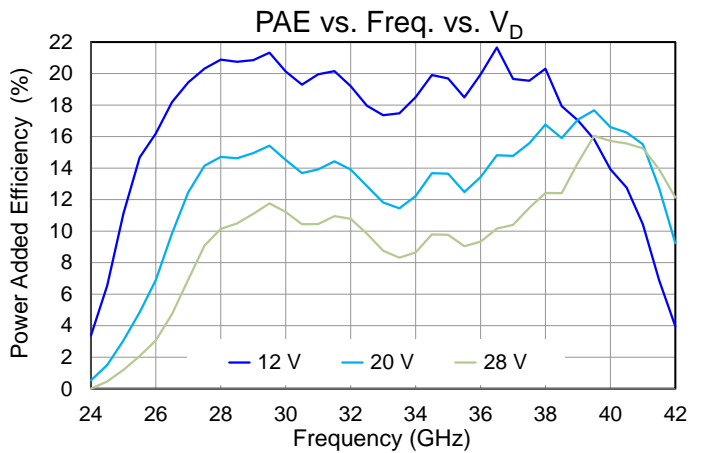
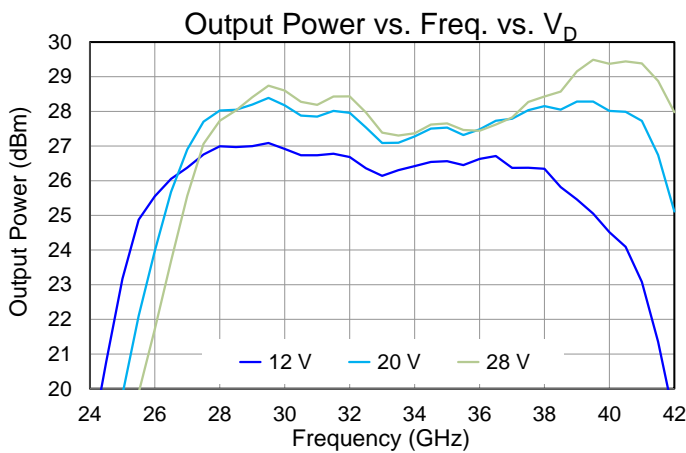
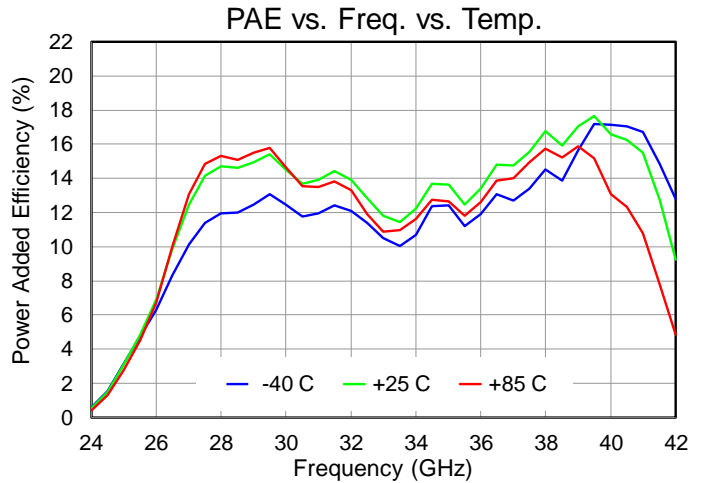
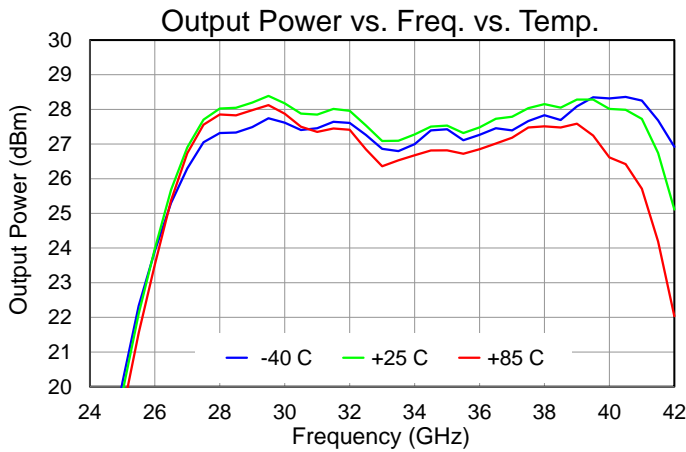

Performance Plots – Large Signal (Pulsed)

Test conditions, unless otherwise noted: Pulsed $V_D = 20\text{ V}$, $I_{DQ} = 64\text{ mA}$, $PW = 100\text{ }\mu\text{s}$, $DC = 10\%$, $P_{IN} = +13\text{dBm}$, $T_{BASE} = +25\text{ }^\circ\text{C}$

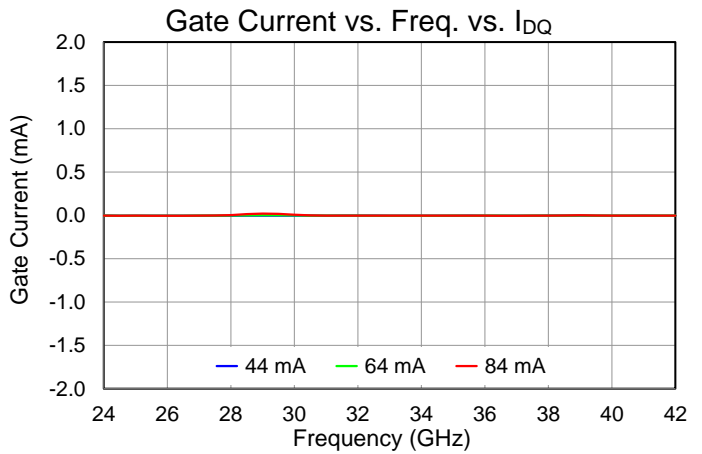
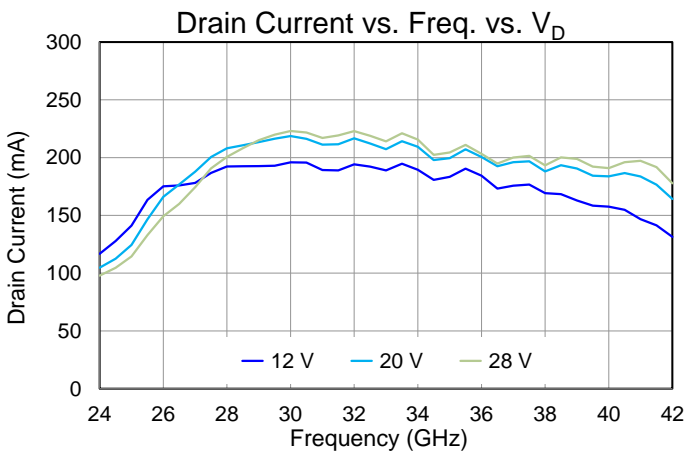
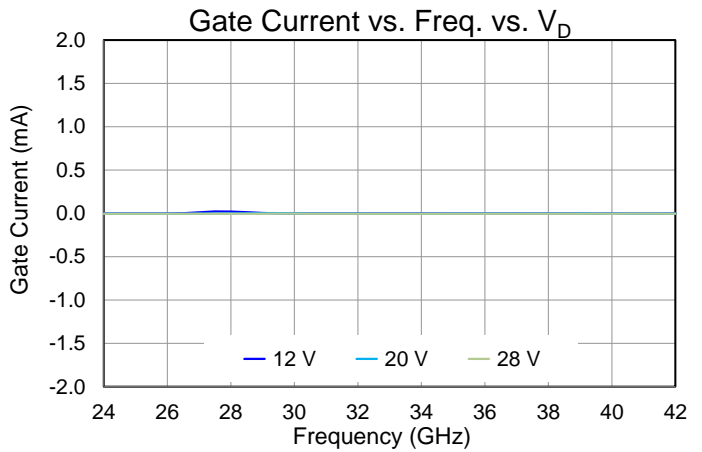
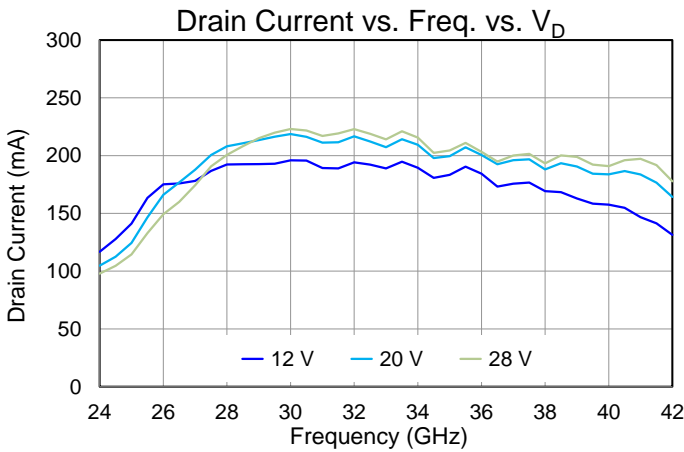
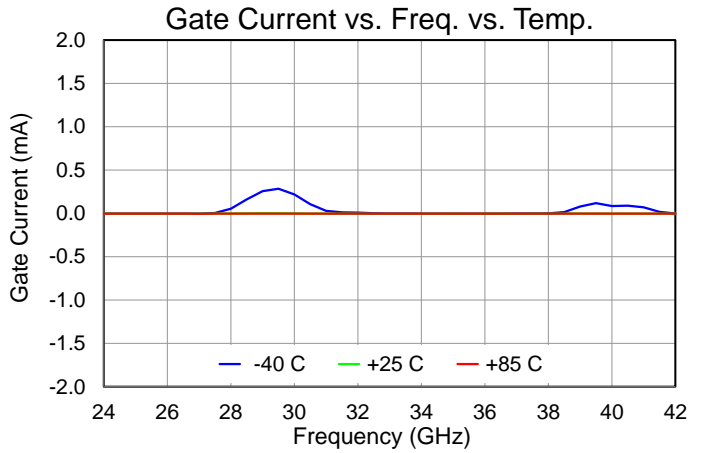
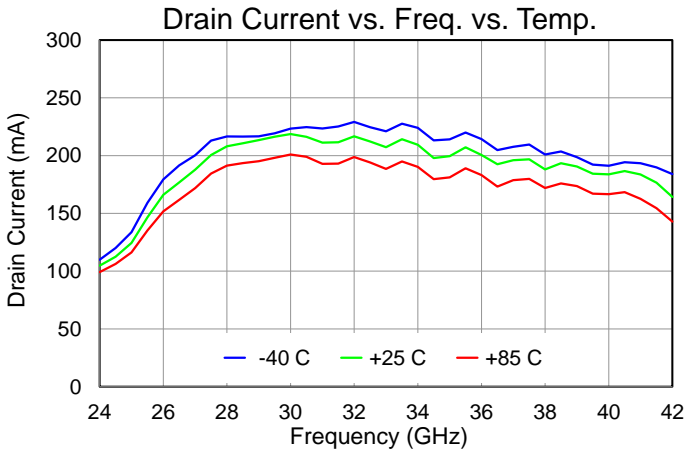

Performance Plots – Large Signal (Pulsed)

Test conditions, unless otherwise noted: Pulsed $V_D = 20\text{ V}$, $I_{DQ} = 64\text{ mA}$, $PW = 100\text{ }\mu\text{s}$, $DC = 10\%$, $P_{IN} = +13\text{ dBm}$, $T_{BASE} = +25\text{ }^\circ\text{C}$

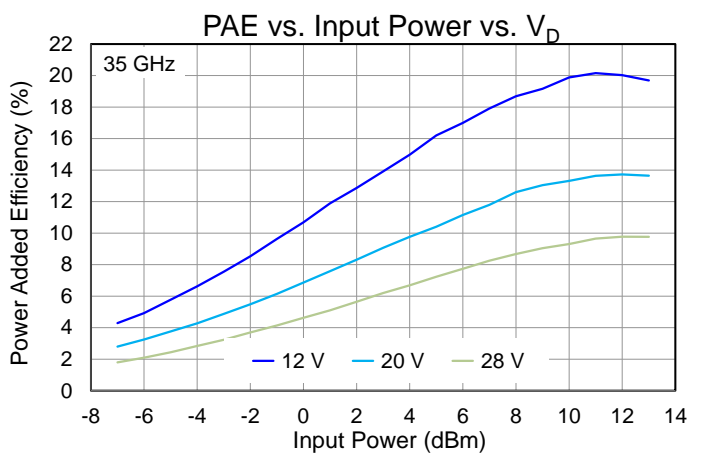
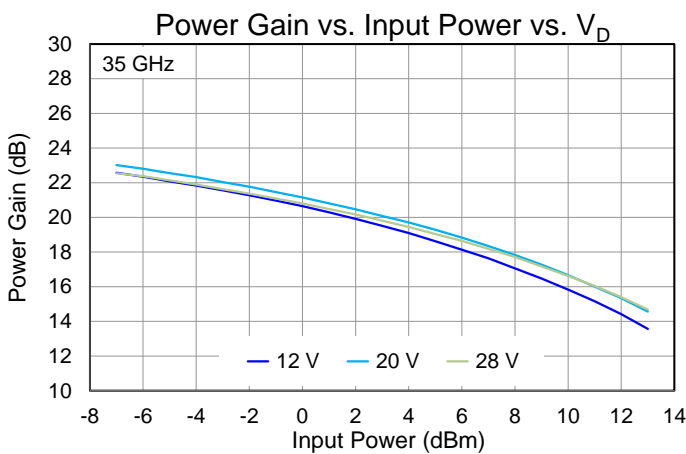
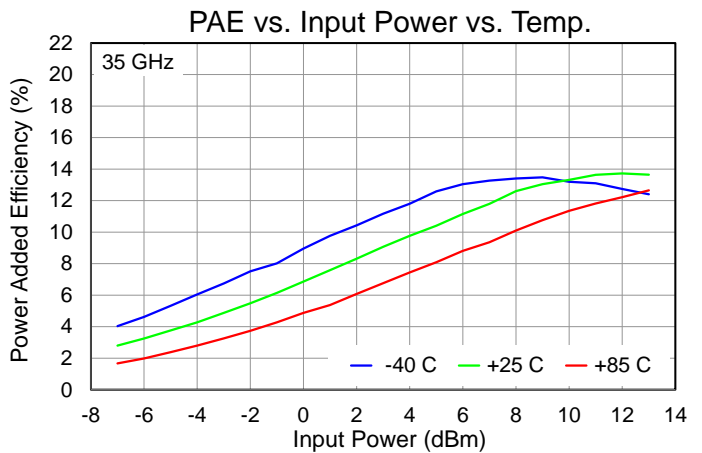
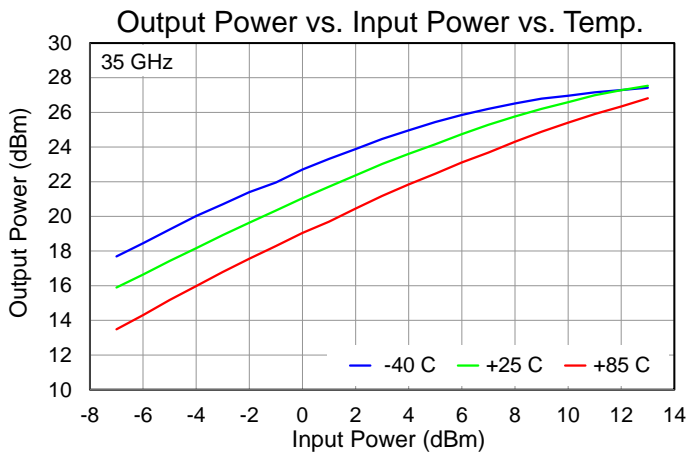
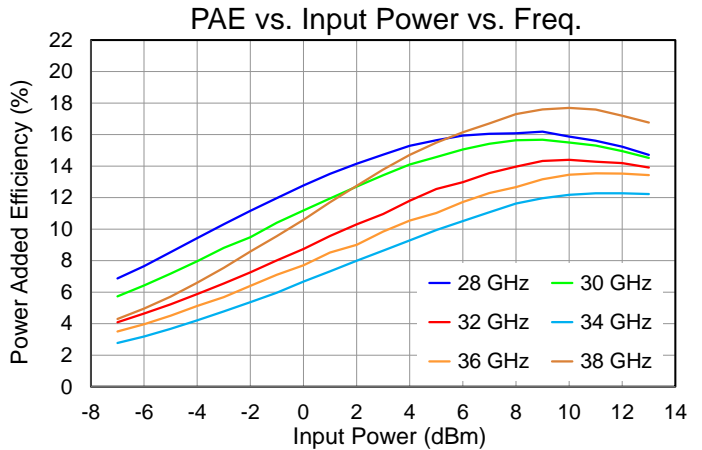
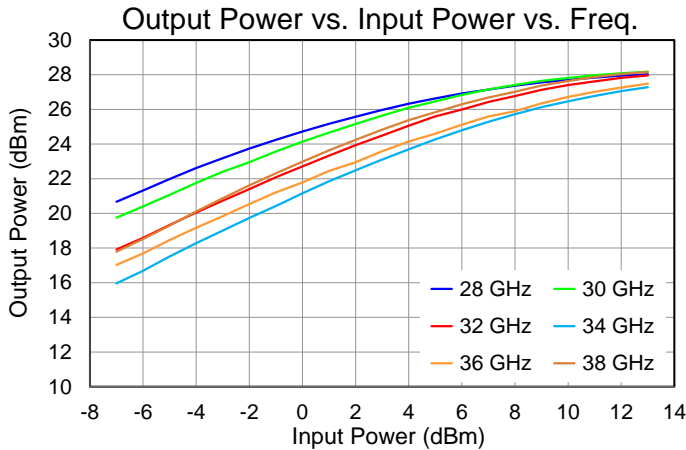

Performance Plots – Large Signal (Pulsed)

Test conditions, unless otherwise noted: Pulsed $V_D = 20\text{ V}$, $I_{DQ} = 64\text{ mA}$, $PW = 100\text{ }\mu\text{s}$, $DC = 10\%$, $P_{IN} = +13\text{ dBm}$, $T_{BASE} = +25\text{ }^\circ\text{C}$

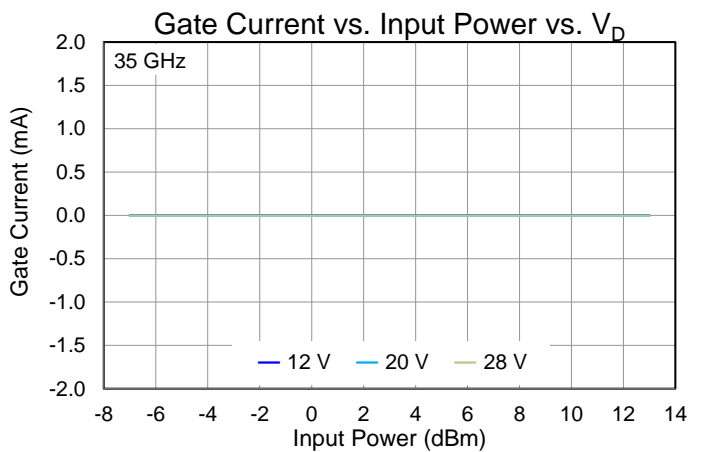
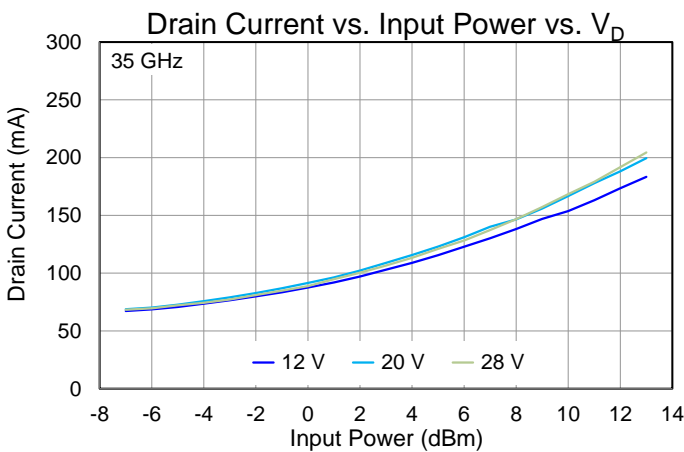
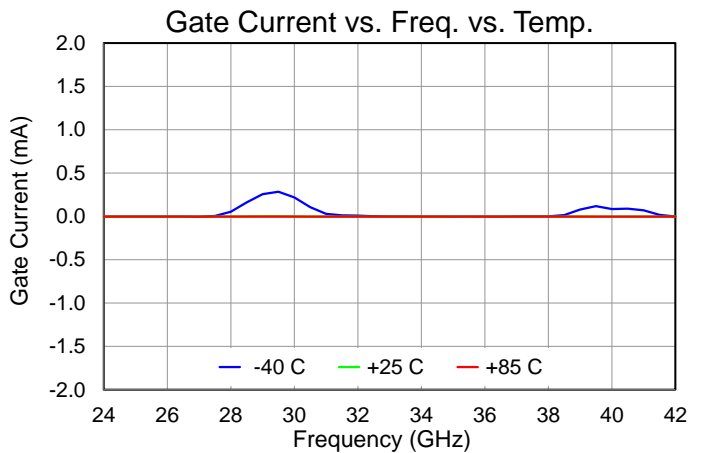
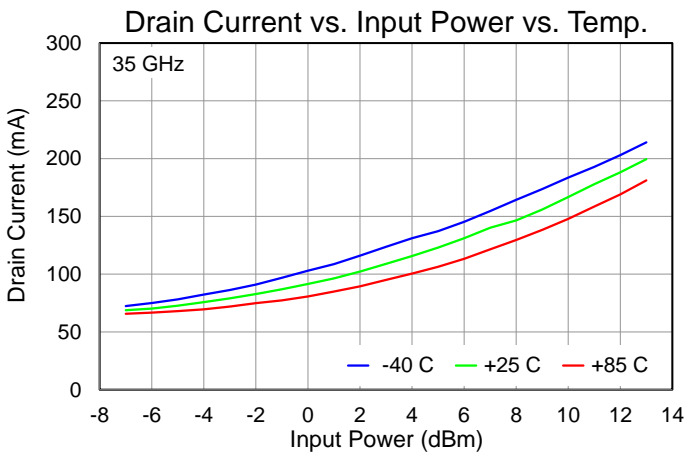
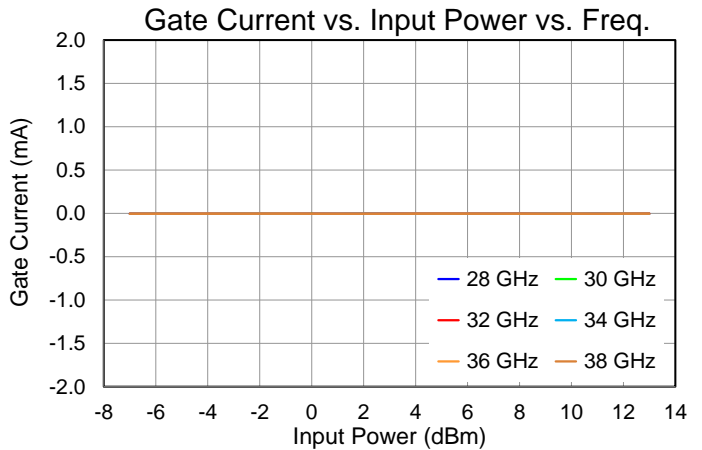
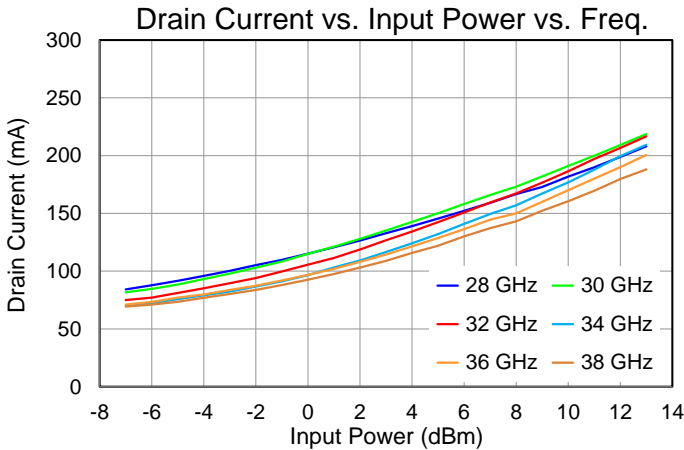

Performance Plots – Large Signal (Pulsed)

Test conditions, unless otherwise noted: Pulsed $V_D = 20\text{ V}$, $I_{DQ} = 64\text{ mA}$, $PW = 100\text{ }\mu\text{s}$, $DC = 10\%$, $P_{IN} = +13\text{ dBm}$, $T_{BASE} = +25\text{ }^\circ\text{C}$

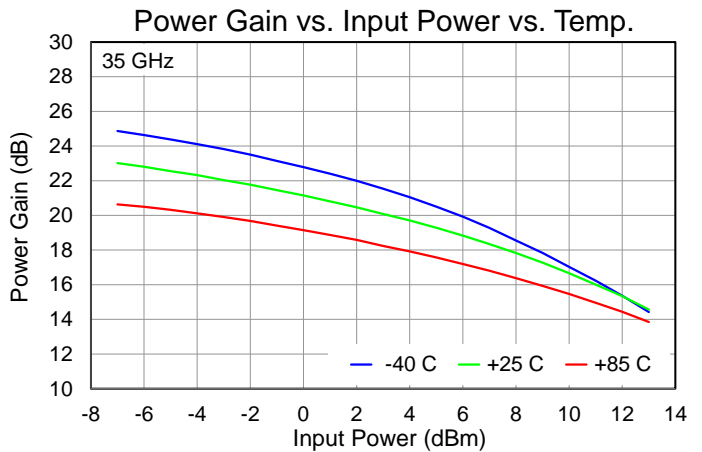
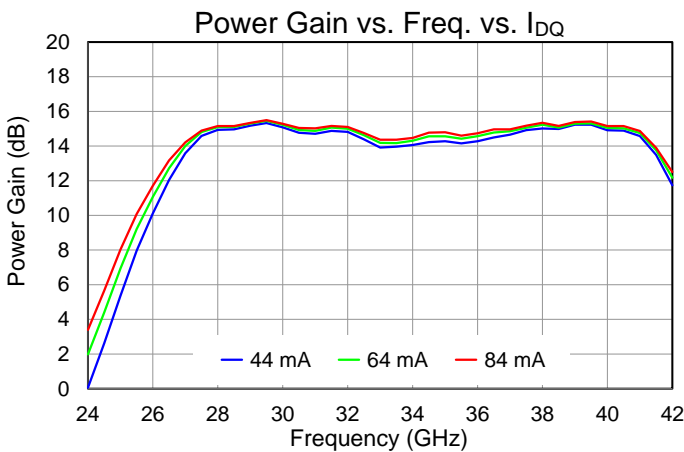
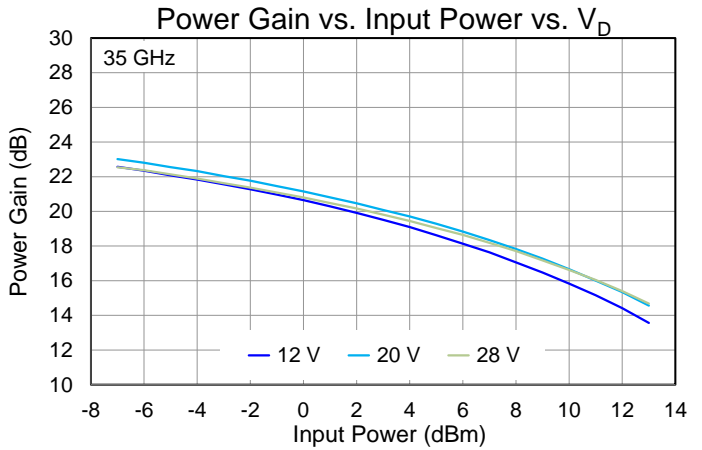
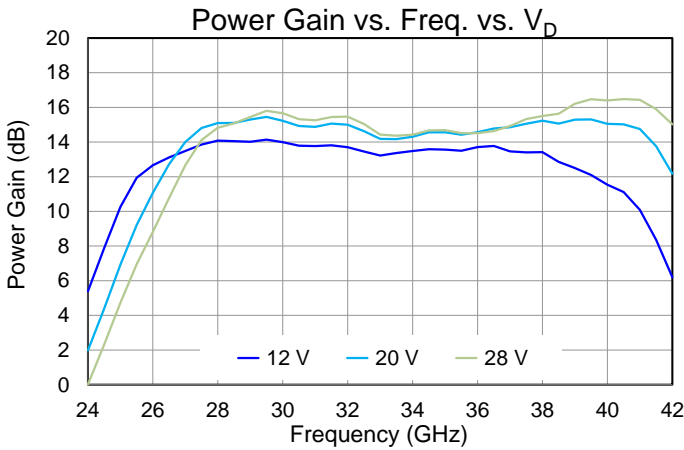
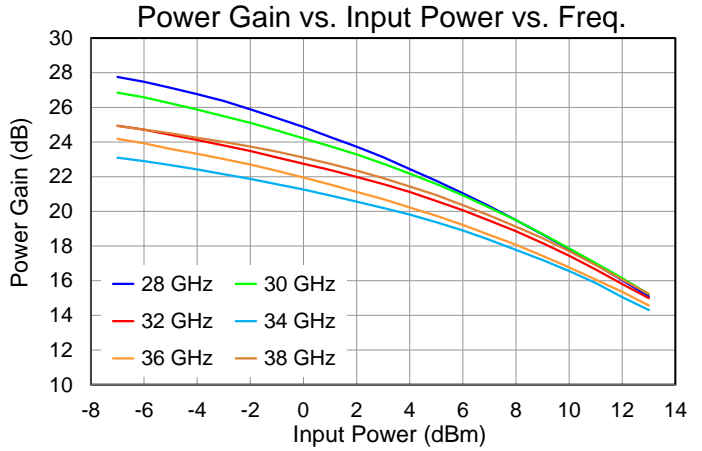
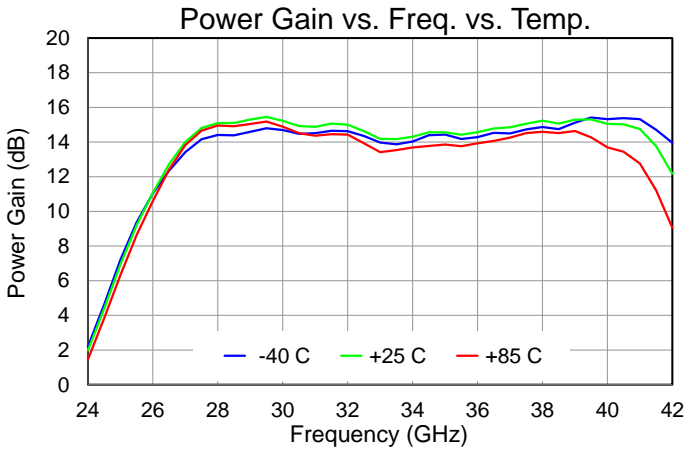

Performance Plots – Linearity

Test conditions, unless otherwise noted: CW, $V_D = 20\text{ V}$, $I_{DQ} = 64\text{ mA}$, $F_C = 28.5\text{ GHz}$, Tone Spacing = 100 MHz, $T_{BASE} = +25\text{ }^\circ\text{C}$

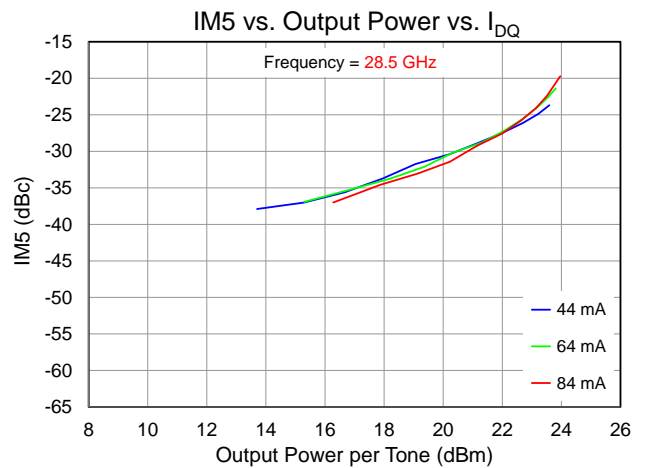
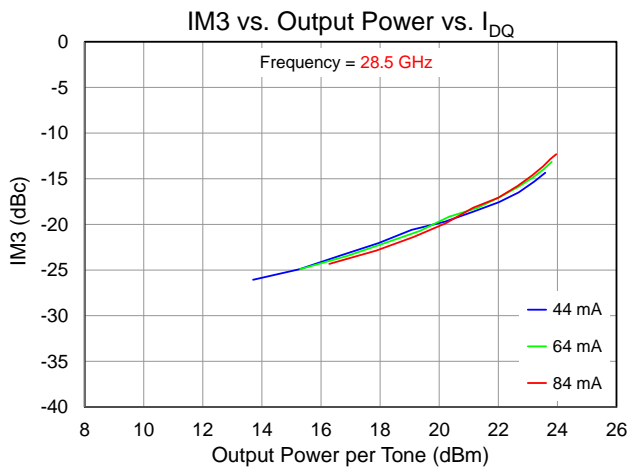
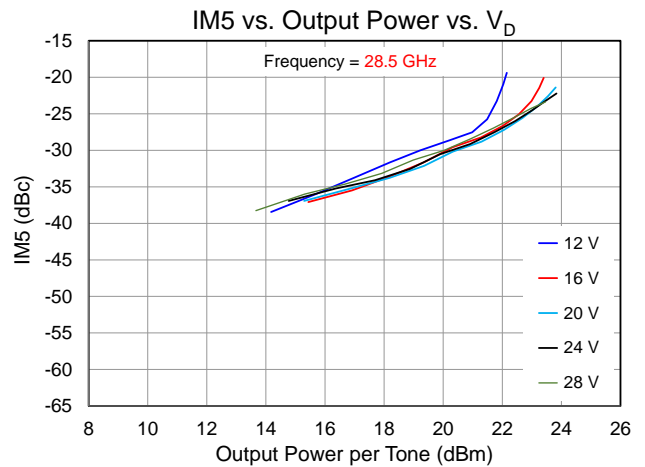
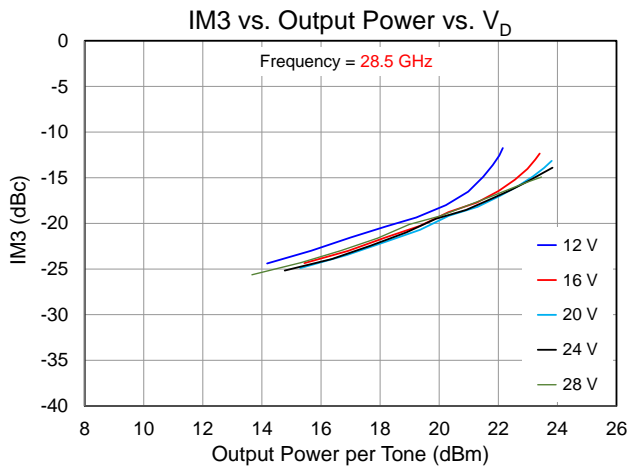
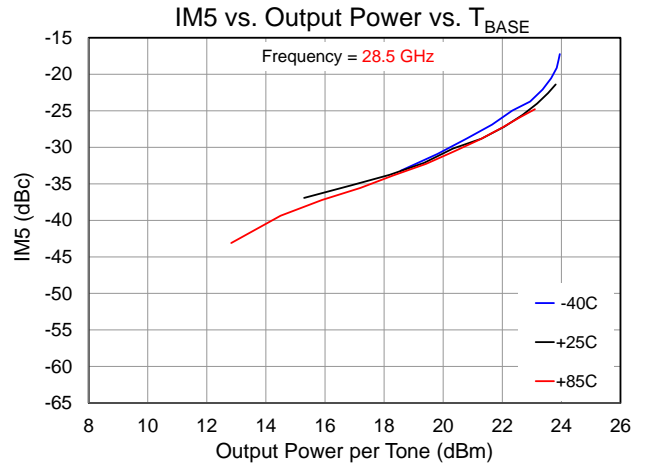
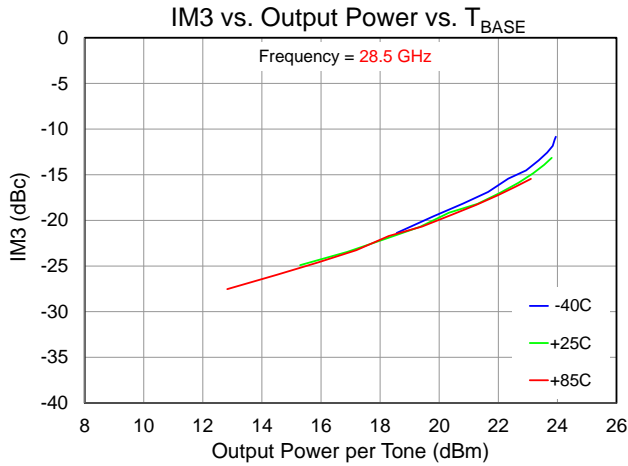

Performance Plots – Linearity

Test conditions, unless otherwise noted: CW, $V_D = 20\text{ V}$, $I_{DQ} = 64\text{ mA}$, $F_c = 35\text{ GHz}$, Tone Spacing = 100 MHz, $T_{BASE} = +25\text{ }^\circ\text{C}$

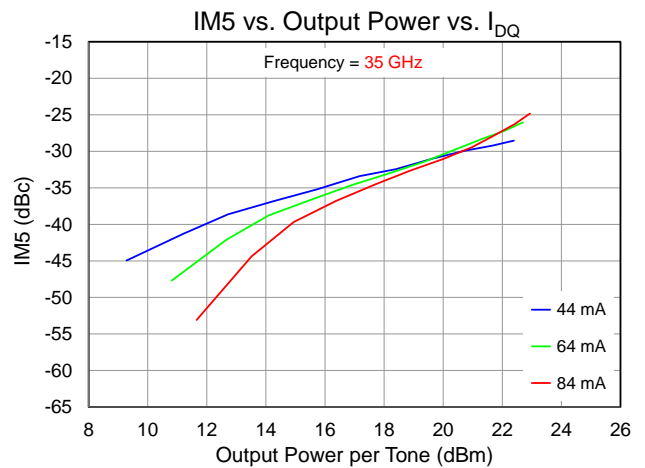
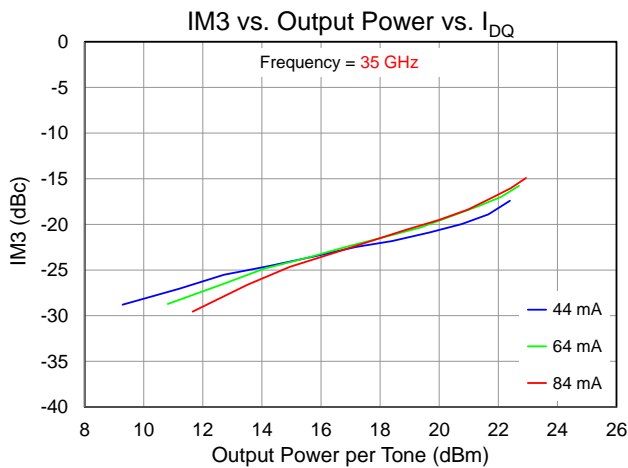
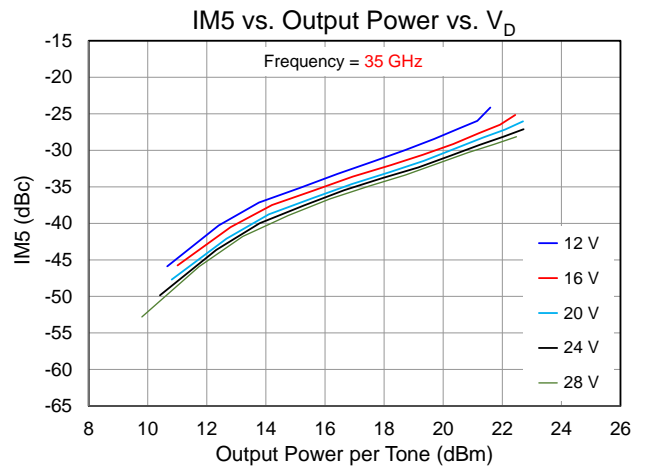
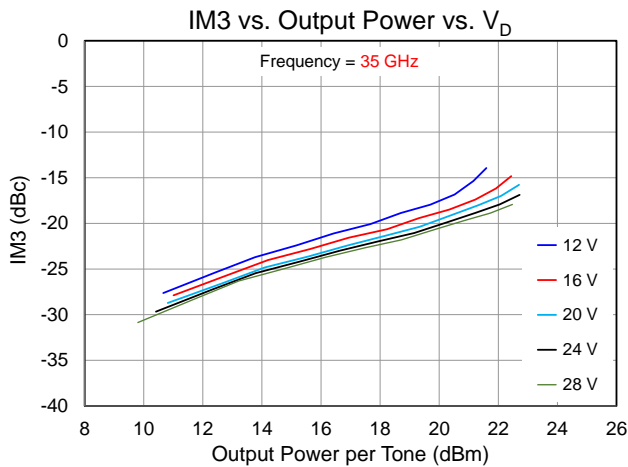
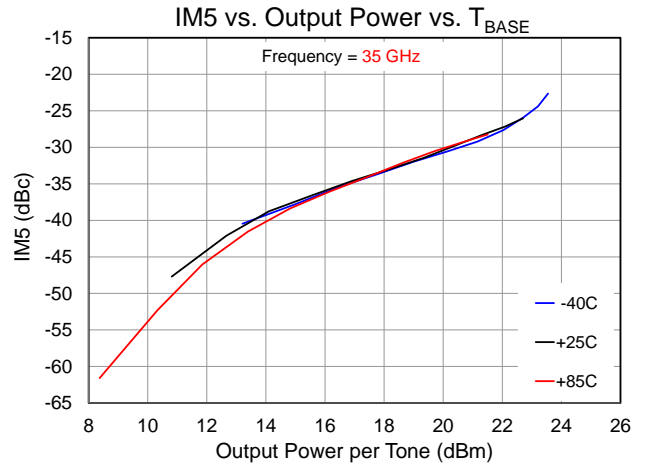
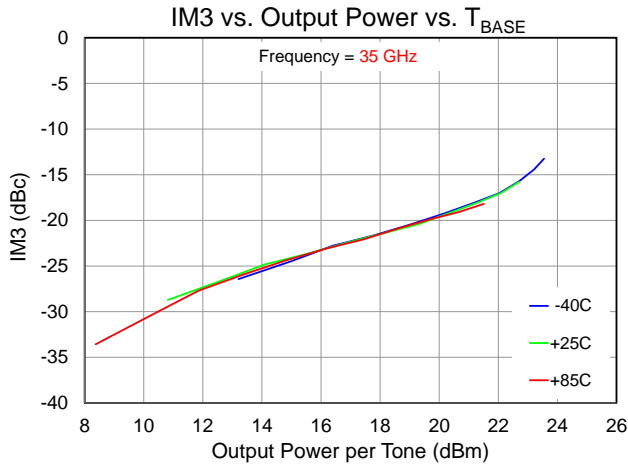

Performance Plots – Linearity

Test conditions, unless otherwise noted: CW, $V_D = 20\text{ V}$, $I_{DQ} = 64\text{ mA}$, $F_c = 38\text{ GHz}$, Tone Spacing = 100 MHz, $T_{BASE} = +25\text{ }^\circ\text{C}$

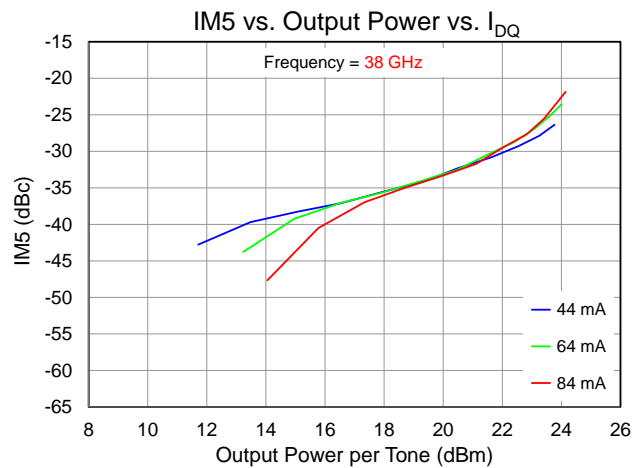
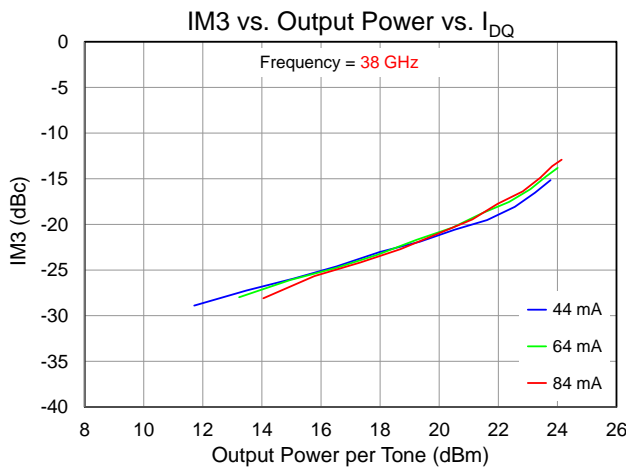
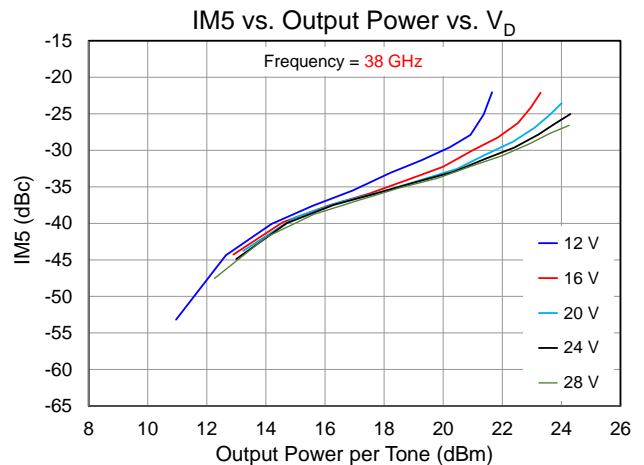
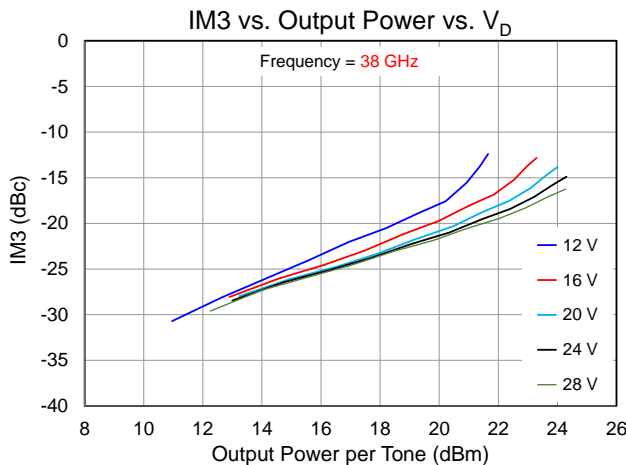
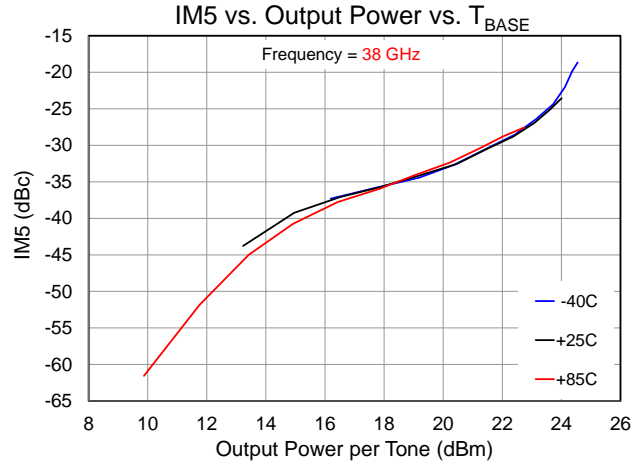
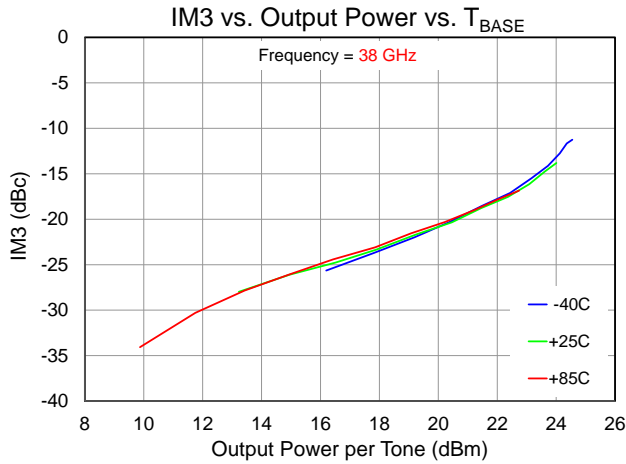

Thermal and Reliability Information

Parameter	Test Conditions	Value	Units
Thermal Resistance (θ_{JC}) ⁽¹⁾	$T_{base} = 85\text{ }^{\circ}\text{C}$, $V_D = 20\text{ V}$, $I_{DQ} = 64\text{ mA}$, $P_{DISS} = 1.28\text{ W}$, No RF (quiescent DC operation)	26.9	$^{\circ}\text{C/W}$
Channel Temperature, T_{CH} (No RF) ⁽²⁾		106	$^{\circ}\text{C}$
Thermal Resistance (θ_{JC}) ⁽¹⁾	$T_{base} = 85\text{ }^{\circ}\text{C}$, $V_D = 20\text{ V}$, $I_{DQ} = 64\text{ mA}$, Freq = 32 GHz, $I_{D_Drive} = 165\text{ mA}$, $P_{IN} = 13\text{ dBm}$, $P_{OUT} = 25.8\text{ dBm}$, $P_{DISS} = 2.95\text{ W}$	17.3	$^{\circ}\text{C/W}$
Channel Temperature, T_{CH} (Under RF) ⁽²⁾		136	$^{\circ}\text{C}$
Thermal Resistance (θ_{JC}) ⁽¹⁾	$T_{base} = 85\text{ }^{\circ}\text{C}$, $V_D = 28\text{ V}$, $I_{DQ} = 64\text{ mA}$, Freq = 32 GHz, $I_{D_Drive} = 158\text{ mA}$, $P_{IN} = 13\text{ dBm}$, $P_{OUT} = 25.5\text{ dBm}$, $P_{DISS} = 4.1\text{ W}$	18.1	$^{\circ}\text{C/W}$
Channel Temperature, T_{CH} (Under RF) ⁽²⁾		159	$^{\circ}\text{C}$

Notes:

- Thermal resistance determined to the back of a 20 mil Cu-Mo carrier plate with eutectic die attach (85 $^{\circ}\text{C}$)
- Refer to the following document: [GaN Device Channel Temperature, Thermal Resistance, and Reliability Estimates](#)

Dissipated Power and Maximum Gate Current

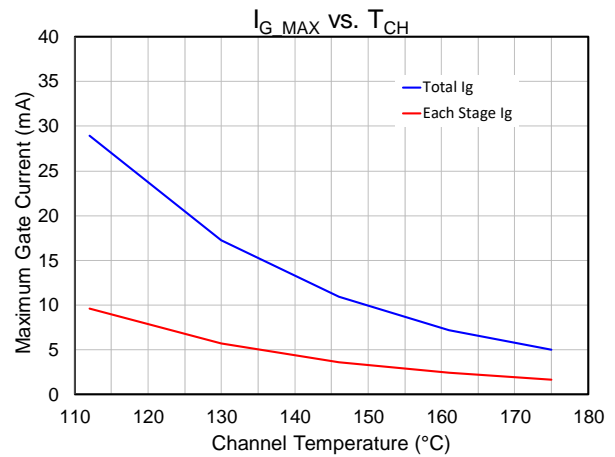
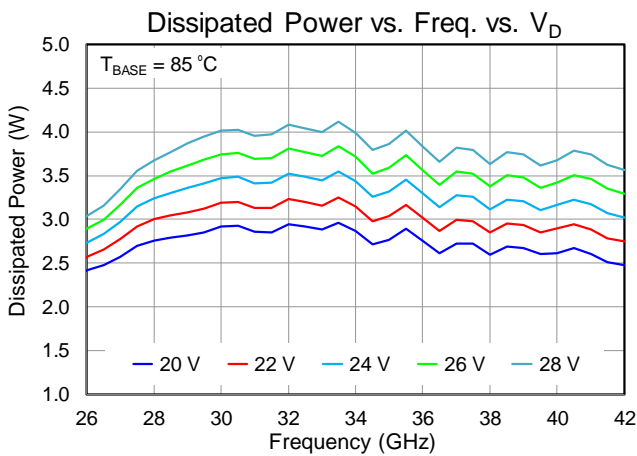

Test conditions, unless otherwise noted: CW, $V_D = 20\text{ V}$, $I_{DQ} = 64\text{ mA}$, $P_{IN} = +13\text{ dBm}$, $T_{BASE} = +85\text{ }^{\circ}\text{C}$

Applications Information

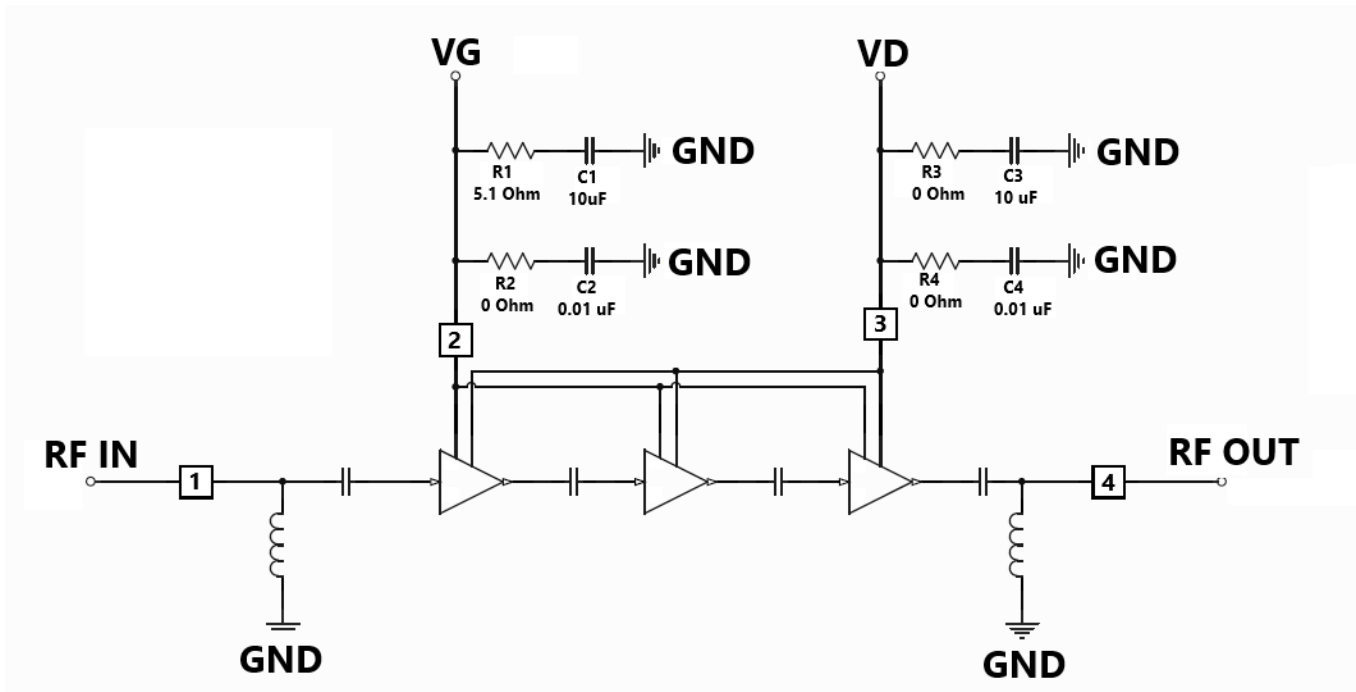

Bias-Up Procedure

1. Set I_D limit to 250 mA, I_G limit to 10 mA
2. Set V_G to -4.0 V
3. Set V_D +20 V
4. Adjust V_G more positive until $I_{DQ} \approx 64$ mA
5. Apply RF signal

Bias-Down Procedure

1. Turn off RF signal
2. Reduce V_G to -4.0 V. Ensure $I_{DQ} \sim 0$ mA
4. Set V_D to 0 V
5. Turn off V_D supply
6. Turn off V_G supply

Evaluation Board (EVB) Layout Assembly

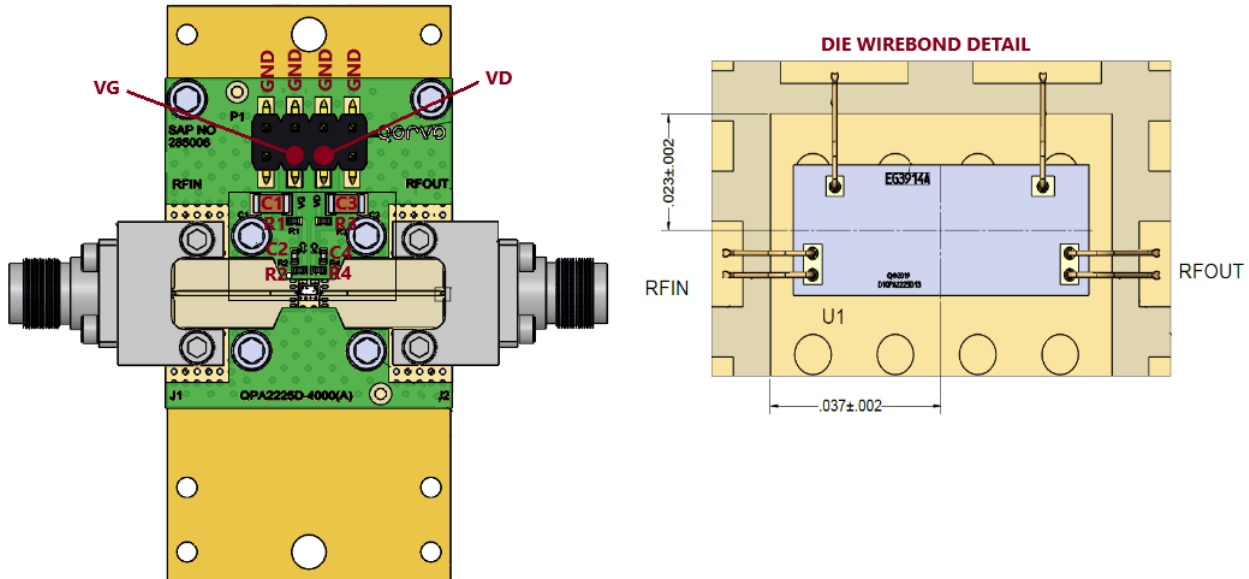

PCB is made from Rogers 4003C dielectric, 0.008 inch thick, 0.5 oz. copper both sides.

Bill of Materials

Reference Des.	Value	Description	Manuf.	Part Number
C1, C3	10 uF	CAP, 10 uF, 20%, 50 V, 20%, X5R, 1206	Various	
C2, C4	0.01 uF	CAP, 0.01 uF, 10%, 50 V, X7R, 0402	Various	
R1	5.1 Ω	RES, 5.1 OHM, 5%, 50 V, 0402	Various	
R2, R3, R4	0 Ω	RES, 0 OHM, JMPR, 0402	Various	
J1, J2	2.4 mm	CONNECTOR, FEMALE, ENDLAUNCH	Southwest Microwave	1492-04A-5

Mechanical Information

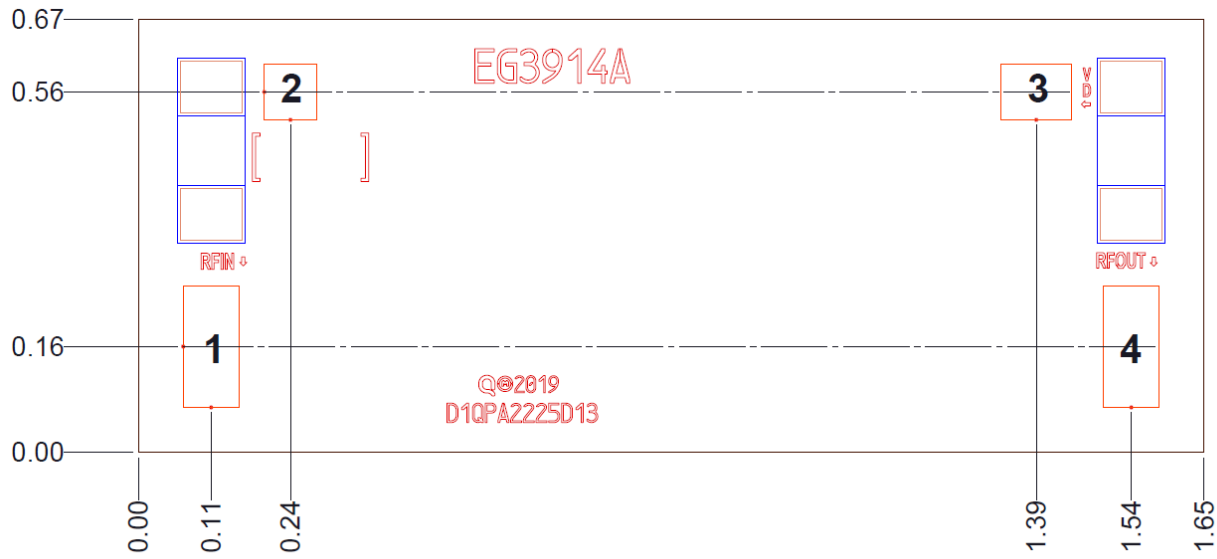

Dimensions are in mm
Thickness: 0.050
Die x, y size tolerance: ± 0.050
Ground is backside of die

Bond Pad Description

Pad No.	Symbol	Pad Size (mm)	Description
1	RF In	0.087 x 0.188	RF Input; matched to 50 Ω, DC blocked
2	VG	0.081 x 0.086	Gate voltage, bias network is required; see Application Circuit on page 19 as an example.
3	VD	0.110 x 0.086	Drain voltage, bias network is required; see Application Circuit on page 19 as an example.
4	RF Out	0.087 x 0.188	RF Output; matched to 50 Ω, DC blocked

Assembly Notes

Component placement and adhesive attachment assembly notes:

- Vacuum pencils and/or vacuum collets are the preferred method of pick up.
- Air bridges must be avoided during placement.
- The force impact is critical during auto placement.

Reflow process assembly notes:

- Use AuSn (80/20) solder and limit exposure to temperatures above 300 °C to 3–4 minutes, maximum.
- An alloy station or conveyor furnace with reducing atmosphere should be used.
- Do not use any kind of flux.
- Coefficient of thermal expansion matching is critical for long-term reliability.
- Devices must be stored in a dry nitrogen atmosphere.

Interconnect process assembly notes:

- Thermosonic ball bonding is the preferred interconnect technique.
- Force, time, and ultrasonic are critical parameters.
- Aluminum wire should not be used.
- Devices with small pad sizes should be bonded with 0.0007-inch wire.

Handling Precautions

Parameter	Rating	Standard
ESD – Human Body Model (HBM)	1B	ANSI/ESD/JEDEC JS-001



Caution!
 ESD-Sensitive Device

Solderability

Use only AuSn (80/20) solder, and limit exposure to temperatures above 300 °C to 3–4 minutes, maximum.

RoHS Compliance

This part is compliant with 2011/65/EU RoHS directive (Restrictions on the Use of Certain Hazardous Substances in Electrical and Electronic Equipment) as amended by Directive 2015/863/EU.

This product also has the following attributes:

- Lead Free
- Halogen Free (Chlorine, Bromine)
- Antimony Free
- TBBP-A (C₁₅H₁₂Br₄O₂) Free
- PFOS Free
- SVHC Free

Contact Information

For the latest specifications, additional product information, worldwide sales and distribution locations:

Web: www.qorvo.com

Tel: 1-844-890-8163

Email: customer.support@qorvo.com

Important Notice

The information contained herein is believed to be reliable; however, Qorvo makes no warranties regarding the information contained herein and assumes no responsibility or liability whatsoever for the use of the information contained herein. All information contained herein is subject to change without notice. Customers should obtain and verify the latest relevant information before placing orders for Qorvo products. The information contained herein or any use of such information does not grant, explicitly or implicitly, to any party any patent rights, licenses, or any other intellectual property rights, whether with regard to such information itself or anything described by such information. **THIS INFORMATION DOES NOT CONSTITUTE A WARRANTY WITH RESPECT TO THE PRODUCTS DESCRIBED HEREIN, AND QORVO HEREBY DISCLAIMS ANY AND ALL WARRANTIES WITH RESPECT TO SUCH PRODUCTS WHETHER EXPRESS OR IMPLIED BY LAW, COURSE OF DEALING, COURSE OF PERFORMANCE, USAGE OF TRADE OR OTHERWISE, INCLUDING THE IMPLIED WARRANTIES OF MERCHANTABILITY AND FITNESS FOR A PARTICULAR PURPOSE.**

Without limiting the generality of the foregoing, Qorvo products are not warranted or authorized for use as critical components in medical, life-saving, or life-sustaining applications, or other applications where a failure would reasonably be expected to cause severe personal injury or death.

Copyright 2019 © Qorvo, Inc. | Qorvo is a registered trademark of Qorvo, Inc.

Mouser Electronics

Authorized Distributor

Click to View Pricing, Inventory, Delivery & Lifecycle Information:

[Qorvo:](#)

[QPA2225DEVBA](#) [QPA2225D](#)