

THYRISTOR MODULE (NON-ISOLATED TYPE)

PWB80A

PWB80A is a Thyristor module suitable for low voltage, 3 phase recifier applications.

- $I_{T(AV)}$ 80A (each device)
- High Surge Current 2500 A (60Hz)
- Easy Construction
- Non-isolated. Mounting base as common Anode terminal

(Applications)

Welding power Supply
Various DC power Supply

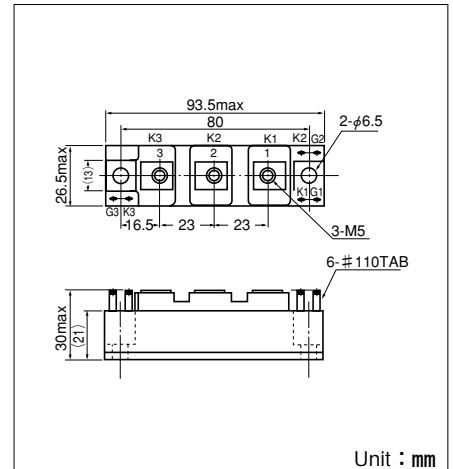
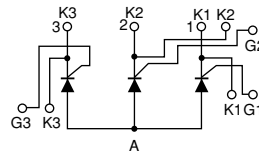

Unit : mm

Maximum Ratings

Symbol	Item	Ratings		Unit
		PWB80A30	PWB80A40	
VRRM	Repetitive Peak Reverse Voltage	300	400	V
VRSM	Non-Repetitive Peak Reverse Voltage	360	480	V
VDRM	Repetitive Peak Off-State Voltage	300	400	V

Symbol	Item	Conditions	Ratings	Unit	
$I_{T(AV)}$	Average On-State Current	Single phase, half wave, 180° conduction, $T_c : 116^\circ\text{C}$	80	A	
$I_{T(RMS)}$	R.M.S. On-State Current	Single phase, half wave, 180° conduction, $T_c : 116^\circ\text{C}$	125	A	
I_{TSM}	Surge On-State Current	1/2 cycle, 50Hz/60Hz, peak value, non-repetitive	2280/2500	A	
I^2t	I^2t		26000	A ² S	
P _{GM}	Peak Gate Power Dissipation		10	W	
P _{G(AV)}	Average Gate Power Dissipation		1	W	
I _{FGM}	Peak Gate Current		3	A	
V _{FGM}	Peak Gate Voltage(Forward)		10	V	
V _{RGM}	Peak Gate Voltage(Reverse)		5	V	
di/dt	Critical Rate of Rise of On-State Current	$I_G=200\text{mA}$, $T_J=25^\circ\text{C}$, $V_D=1/2V_{DRM}$, $dI_G/dt=1\text{A}/\mu\text{s}$	50	A/ μs	
T _J	Operating Junction Temperature		-30 to +150	°C	
T _{stg}	Storage Temperature		-30 to +125	°C	
	Mounting torque	Mounting (M6)	Recommended Value 2.5-3.9 (25-40)	4.7 (48)	N·m (kgf·cm)
		Terminal (M5)	Recommended Value 1.5-2.5 (15-25)	2.7 (28)	
	Mass			170	g

Electrical Characteristics

Symbol	Item	Conditions	Ratings	Unit
I _{DRM}	Repetitive Peak Off-State Current, max.	at V_{DRM} , single phase, half wave, $T_J=150^\circ\text{C}$	12	mA
I _{RRM}	Repetitive Peak Reverse Current, max.	at V_{DRM} , single phase, half wave, $T_J=150^\circ\text{C}$	12	mA
V _{TM}	Peak On-State Voltage, max	On-State Current 240A, $T_J=25^\circ\text{C}$ Inst. measurement	1.20	V
I _{GT} /V _{GT}	Gate Trigger Current/Voltage, max.	$T_J=25^\circ\text{C}$, $I_T=1\text{A}$, $V_D=6\text{V}$	150/2	mA/V
V _{GD}	Non-Trigger Gate, Voltage. min.	$T_J=150^\circ\text{C}$, $V_D=1/2V_{DRM}$	0.25	V
t _{gt}	Turn On Time, max.	$I_T=80\text{A}$, $I_G=200\text{mA}$, $T_J=25^\circ\text{C}$, $V_D=1/2V_{DRM}$, $dI_G/dt=1\text{A}/\mu\text{s}$	10	μs
dv/dt	Critical Rate of Rise of Off-State Voltage, min.	$T_J=150^\circ\text{C}$, $V_D=2/3V_{DRM}$, Exponential wave.	50	V/ μs
I _H	Holding Current, typ.	$T_J=25^\circ\text{C}$	100	mA
R _{th(j-c)}	Thermal Impedance, max.	Junction to case (1/3 Module)	0.35	°C/W

SanRex®

50 Seaview Blvd. Port Washington, NY 11050-4618 PH.(516)625-1313 FAX(516)625-8845 E-mail: semi@sanrex.com

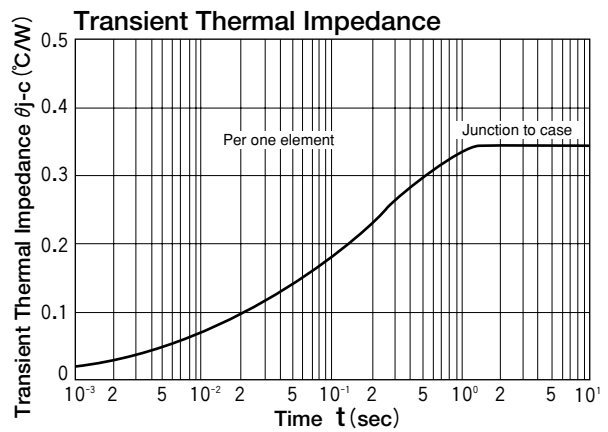
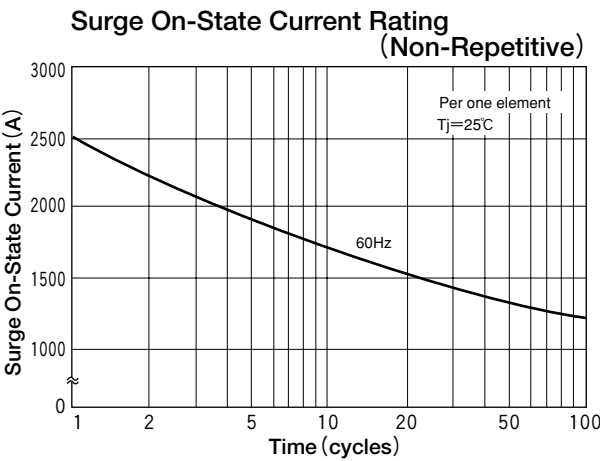
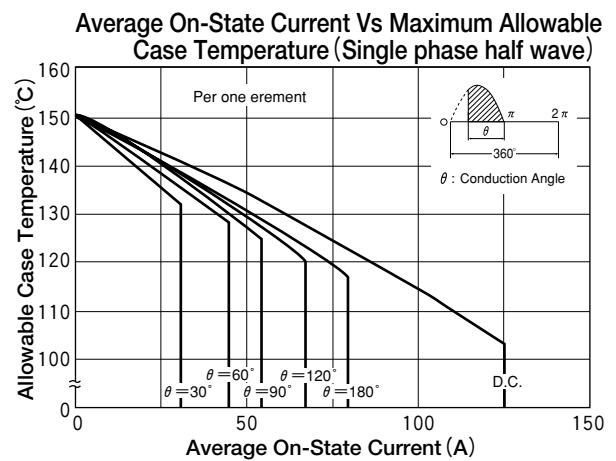
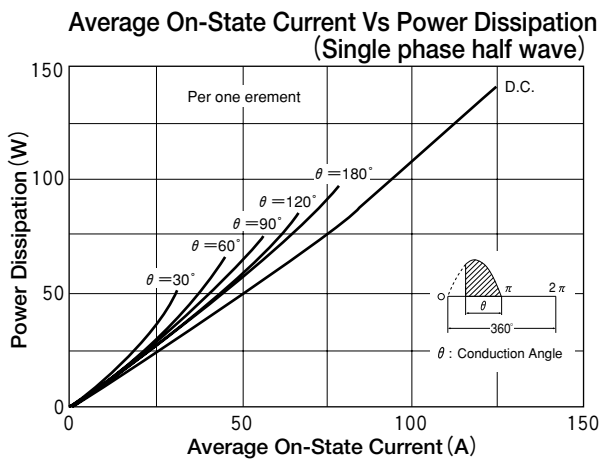
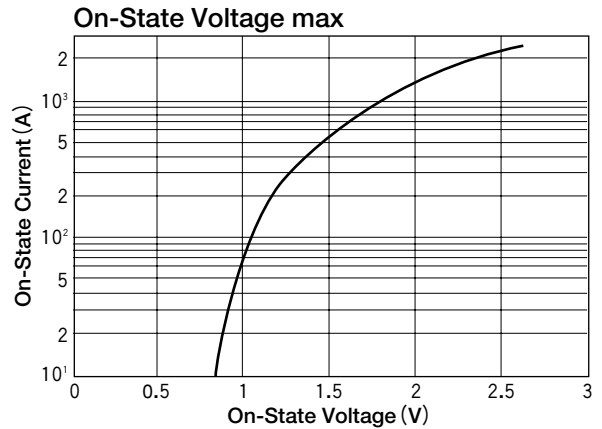
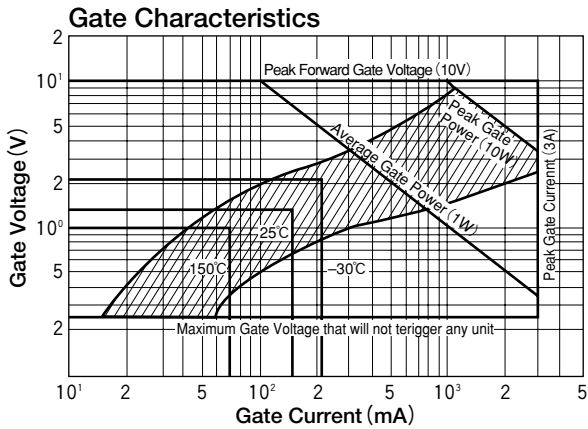

Mouser Electronics

Authorized Distributor

Click to View Pricing, Inventory, Delivery & Lifecycle Information:

[SanRex:](#)

[PWB80A30](#) [PWB80A40](#)