

MSCSM120HM16CT3AG
Datasheet
Full Bridge SiC MOSFET Power Module

January 2020



a  **MICROCHIP** company

Contents

Revision History	1
1.1 Revision 1.0.....	1
Product Overview	2
2.1 Features.....	3
2.2 Benefits.....	3
2.3 Applications.....	3
Electrical Specifications	4
3.1 SiC MOSFET Characteristics (Per MOSFET).....	4
3.2 Reverse SiC Diode Ratings and Characteristics (Per SiC Diode).....	6
3.3 Thermal and Package Characteristics.....	6
3.4 Typical SiC MOSFET Performance Curves.....	8
3.5 Typical SiC Diode Performance Curves.....	11
Package Specifications	12
Package Outline Drawing.....	12

1 Revision History

The revision history describes the changes that were implemented in the document. The changes are listed by revision, starting with the most current publication.

1.1 Revision 1.0

Revision 1.0 was published in January 2020. It is the first publication of this document.

2 Product Overview

This MSCSM120HM16CT3AG device is a full bridge 1200 V/173 A full Silicon Carbide (SiC) power module.

Figure 1 • MSCSM120HM16CT3AG Electrical Schematic

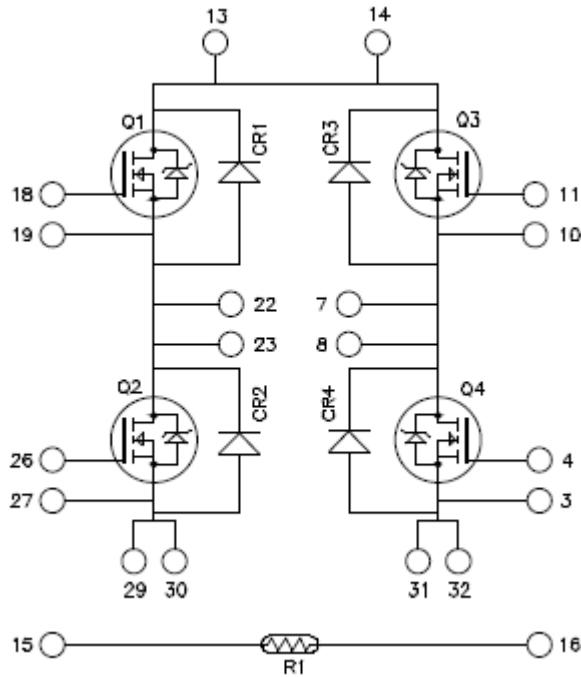
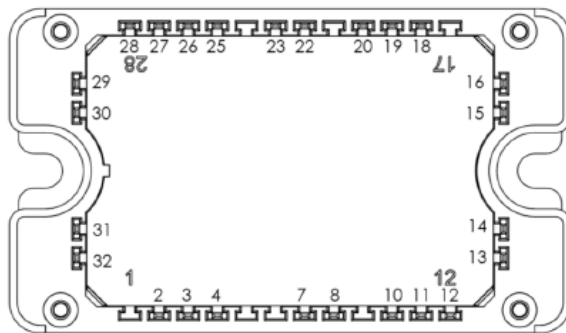

Figure 2 • MSCSM120HM16CT3AG Pinout Location



All multiple inputs & outputs must be shorted together
 Example: 13/14 ; 29/30 ; 22/23 ...

All ratings at $T_j = 25\text{ }^\circ\text{C}$, unless otherwise specified.

Caution: These devices are sensitive to electrostatic discharge. Proper handling procedures should be followed.

2.1 Features

The following are key features of the MSCSM120HM16CT3AG device:

- SiC Power MOSFET
 - Low $R_{DS(on)}$
 - High temperature performance
- SiC Schottky Diode
 - Zero reverse recovery
 - Zero forward recovery
 - Temperature independent switching behavior
 - Positive temperature coefficient on VF
- Very low stray inductance
- Internal thermistor for temperature monitoring
- Aluminum nitride (AlN) substrate for improved thermal performance

2.2 Benefits

The following are benefits of the MSCSM120HM16CT3AG device:

- High power and efficiency converters and inverters
- Outstanding performance at high frequency operation
- Direct mounting to heatsink (isolated package)
- Low junction-to-case thermal resistance
- Solderable terminals for power and signal, for easy PCB mounting
- Low profile
- RoHS compliant

2.3 Applications

The MSCSM120HM16CT3AG device is designed for the following applications:

- Uninterruptible power supplies
- Switched mode power supplies
- EV motor and traction drive
- Welding converters

3 Electrical Specifications

This section shows the electrical specifications of the MSCSM120HM16CT3AG device.

3.1 SiC MOSFET Characteristics (Per MOSFET)

The following table lists the absolute maximum ratings per MOSFET of the MSCSM120HM16CT3AG device.

Table 1 • Absolute Maximum Ratings

Symbol	Parameter	Max Ratings	Unit
V_{DSS}	Drain-source voltage	1200	V
I_D	Continuous drain current	$T_C = 25\text{ }^\circ\text{C}$	173^1
		$T_C = 80\text{ }^\circ\text{C}$	138^1
I_{DM}	Pulsed drain current	350	
V_{GS}	Gate-source voltage	-10/25	V
$R_{DS(on)}$	Drain-source ON resistance	16	m Ω
P_D	Power dissipation	$T_C = 25\text{ }^\circ\text{C}$	745

Note:

1. Specification of SiC MOSFET device, but output current must be limited due to size of power connectors.

The following table lists the electrical characteristics per MOSFET of the MSCSM120HM16CT3AG device.

Table 2 • Electrical Characteristics

Symbol	Characteristic	Test Conditions	Min	Typ	Max	Unit
I_{DSS}	Zero gate voltage drain current	$V_{GS} = 0\text{ V}; V_{DS} = 1200\text{ V}$		20	200	μA
$R_{DS(on)}$	Drain-source on resistance	$V_{GS} = 20\text{ V}$ $I_D = 80\text{ A}$	$T_J = 25\text{ }^\circ\text{C}$	12.5	16	m Ω
			$T_J = 175\text{ }^\circ\text{C}$	20		
$V_{GS(th)}$	Gate threshold voltage	$V_{GS} = V_{DS}, I_D = 2\text{ mA}$	1.8	2.8		V
I_{GSS}	Gate-source leakage current	$V_{GS} = 20\text{ V}, V_{DS} = 0\text{ V}$			200	nA

The following table lists the dynamic characteristics per MOSFET of the MSCSM120HM16CT3AG device.

Table 3 • Dynamic Characteristics

Symbol	Characteristic	Test Conditions	Min	Typ	Max	Unit
C_{iss}	Input capacitance	$V_{GS} = 0\text{ V}$ $V_{DS} = 1000\text{ V}$ $f = 1\text{ MHz}$		6040		pF
C_{oss}	Output capacitance			540		
C_{rss}	Reverse transfer capacitance			50		
Q_g	Total gate charge	$V_{GS} = -5\text{ V}/20\text{ V}$ $V_{Bus} = 800\text{ V}$ $I_D = 80\text{ A}$		464		nC
Q_{gs}	Gate-source charge			82		
Q_{gd}	Gate-drain charge			100		
$T_{d(on)}$	Turn-on delay time	$V_{GS} = -5\text{ V}/20\text{ V}$ $V_{Bus} = 600\text{ V}$ $I_D = 100\text{ A}$ $R_{Gon} = 4\ \Omega$; $R_{Goff} = 2.4\ \Omega$		30		ns
T_r	Rise time			30		
$T_{d(off)}$	Turn-off delay time			50		
T_f	Fall time			25		
E_{on}	Turn on energy	Inductive switching	$T_J = 150\text{ }^\circ\text{C}$	1.98		mJ
E_{off}	Turn off energy	$V_{GS} = -5\text{ V}/20\text{ V}$ $V_{Bus} = 600\text{ V}$ $I_D = 100\text{ A}$ $R_{Gon} = 4\ \Omega$ $R_{Goff} = 2.4\ \Omega$	$T_J = 150\text{ }^\circ\text{C}$	1.3		mJ
R_{Gint}	Internal gate resistance			2.94		Ω
R_{thJC}	Junction-to-case thermal resistance				0.2	$^\circ\text{C}/\text{W}$

The following table lists the body diode ratings and characteristics per MOSFET of the MSCSM120HM16CT3AG device.

Table 4 • Body Diode Ratings and Characteristics

Symbol	Characteristic	Test Conditions	Min	Typ	Max	Unit
V_{SD}	Diode forward voltage	$V_{GS} = 0\text{ V}$; $I_{SD} = 80\text{ A}$ $V_{GS} = -5\text{ V}$; $I_{SD} = 80\text{ A}$		4.0		V
				4.2		
t_{rr}	Reverse recovery time	$I_{SD} = 80\text{ A}$; $V_{GS} = -5\text{ V}$ $V_R = 800\text{ V}$; $d_i/dt = 2000\text{ A}/\mu\text{s}$		90		ns
Q_{rr}	Reverse recovery charge			1100		nC
I_{rr}	Reverse recovery current			27		A

3.2 Reverse SiC Diode Ratings and Characteristics (Per SiC Diode)

The following table lists the reverse SiC diode ratings and characteristics per SiC diode of the MSCSM120HM16CT3AG device.

Table 5 • Reverse SiC Diode Ratings and Characteristics (per SiC diode)

Symbol	Characteristic	Test Conditions		Min	Typ	Max	Unit
V_{RRM}	Peak repetitive reverse voltage					1200	V
I_{RM}	Reverse leakage current	$V_R = 1200\text{ V}$	$T_J = 25\text{ }^\circ\text{C}$	20	400		μA
			$T_J = 175\text{ }^\circ\text{C}$		300		
I_F	DC forward current				60		A
V_F	Diode forward voltage	$I_F = 60\text{ A}$	$T_J = 25\text{ }^\circ\text{C}$	1.5	1.8		V
			$T_J = 175\text{ }^\circ\text{C}$		2.1		
QC	Total capacitive charge	$V_R = 600\text{ V}$			260		nC
C	Total capacitance	$f = 1\text{ MHz}, V_R = 400\text{ V}$			282		pF
		$f = 1\text{ MHz}, V_R = 800\text{ V}$			210		
R_{thJC}	Junction-to-case thermal resistance					0.477	$^\circ\text{C/W}$

3.3 Thermal and Package Characteristics

The following table lists the package characteristics of the MSCSM120HM16CT3AG device.

Table 6 • Package Characteristics

Symbol	Characteristic			Min	Max	Unit
V_{ISOL}	RMS isolation voltage, any terminal to case $t = 1\text{ min}$, 50 Hz/60 Hz			4000		V
T_J	Operating junction temperature range			-40	175	$^\circ\text{C}$
T_{JOP}	Recommended junction temperature under switching conditions			-40	$T_{Jmax}-25$	
T_{STG}	Storage temperature range			-40	125	
T_C	Operating case temperature			-40	125	
Torque	Mounting torque	To heatsink	M4	2	3	N.m
Wt	Package weight				110	g

The following table lists the temperature sensor NTC (see application note [APT0406](#) on www.microsemi.com) of the MSCSM120HM16CT3AG device.

Table 7 • Temperature Sensor NTC

Symbol	Characteristic	Min	Typ	Max	Unit
R ₂₅	Resistance at 25 °C		50		kΩ
ΔR ₂₅ /R ₂₅			5		%
B _{25/85}	T ₂₅ = 298.15 K		3952		K
ΔB/B			4		%
	T _C = 100 °C				

$$R_T = \frac{R_{25}}{\exp\left[B_{25/85}\left(\frac{1}{T_{25}} - \frac{1}{T}\right)\right]}$$

T: Thermistor temperature
 R_T: Thermistor value at T

3.4 Typical SiC MOSFET Performance Curves

This sections shows the typical SiC MOSFET performance curves of the MSCSM120HM16CT3AG device.

Figure 3 • Maximum Thermal Impedance

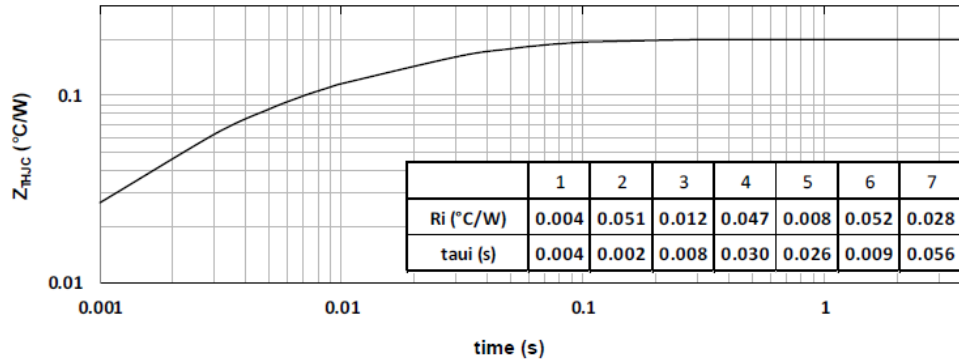

Figure 4 • Output Characteristics at T_J = 25 °C

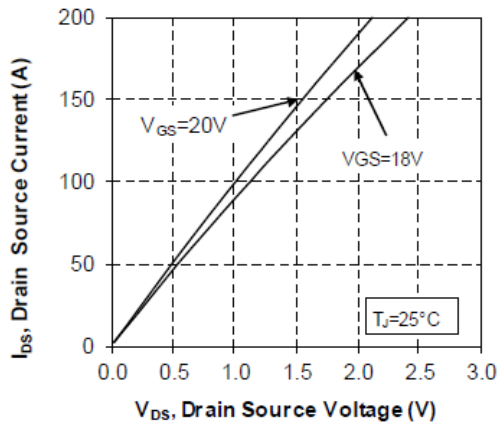

Figure 5 • Output Characteristics at T_J = 175 °C

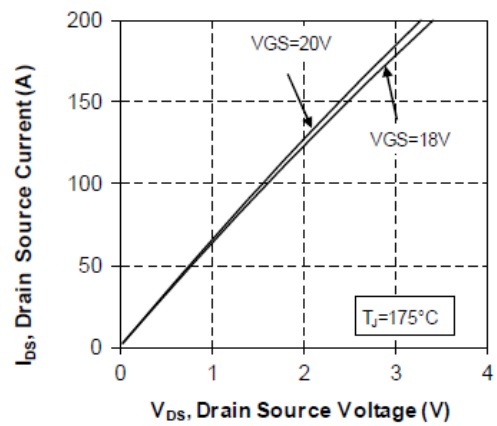

Figure 6 • Normalized R_{DS(on)} vs. Temperature

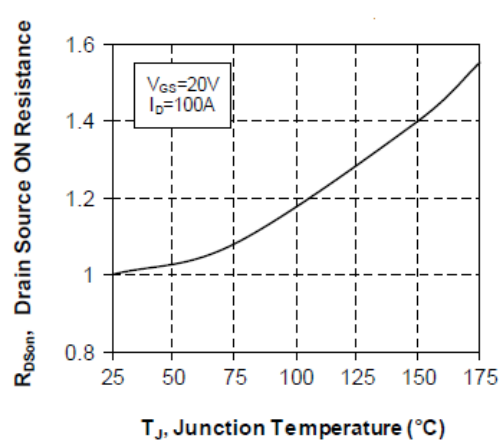

Figure 7 • Transfer Characteristics

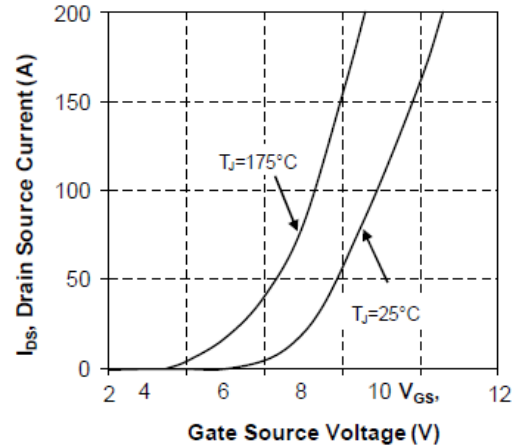

Figure 8 • Switching Energy vs. Rg

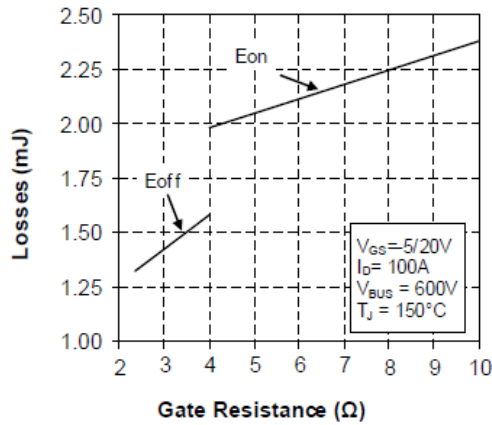

Figure 9 • Switching energy vs Current

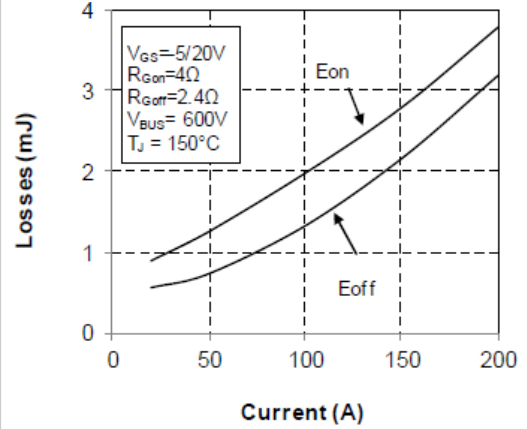

Figure 10 • Capacitance vs. Drain Source Voltage

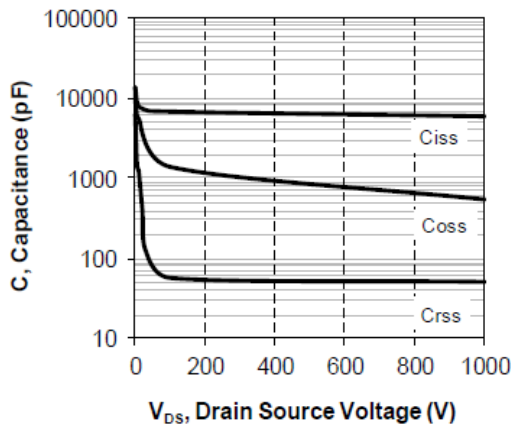

Figure 11 • Gate Charge vs. Gate Source Voltage

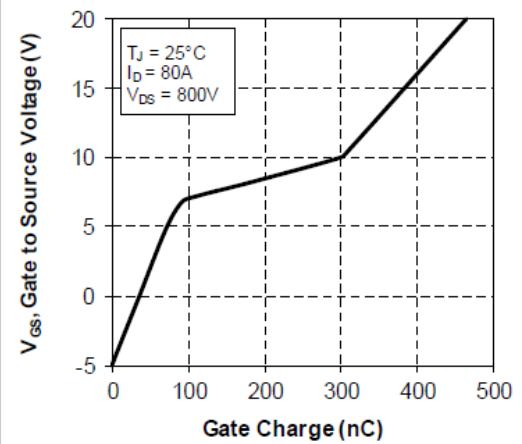

Figure 12 • Body Diode Characteristics at TJ = 25 °C

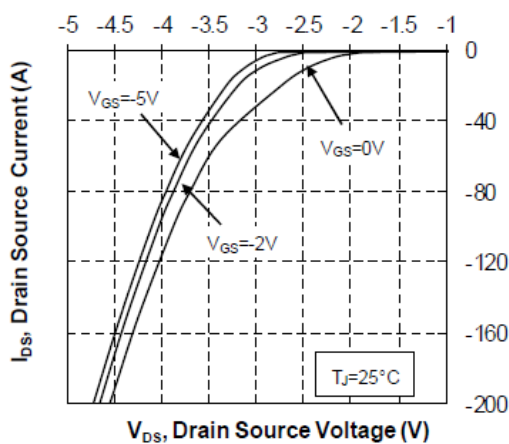

Figure 13 • 3rd Quadrant Characteristics at TJ = 25 °C

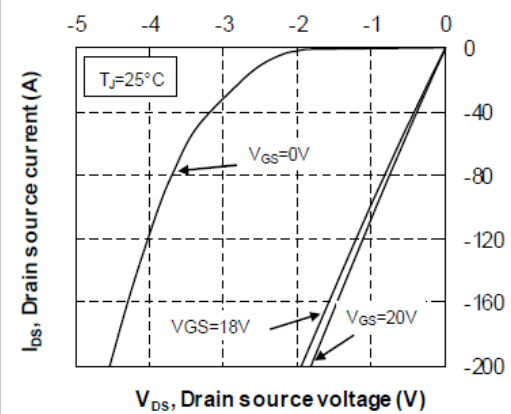

Figure 14 • Body Diode Characteristics at $T_J = 175^\circ\text{C}$

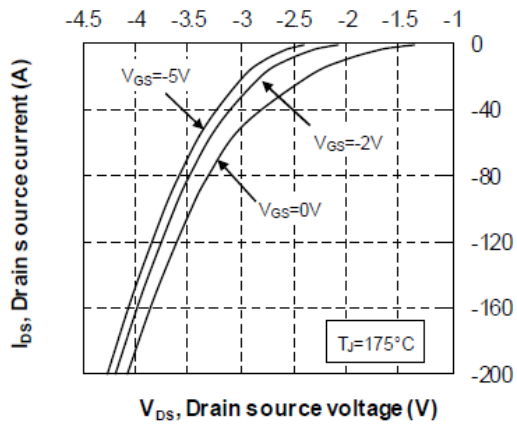

Figure 15 • 3rd Quadrant Characteristics at $T_J = 175^\circ\text{C}$

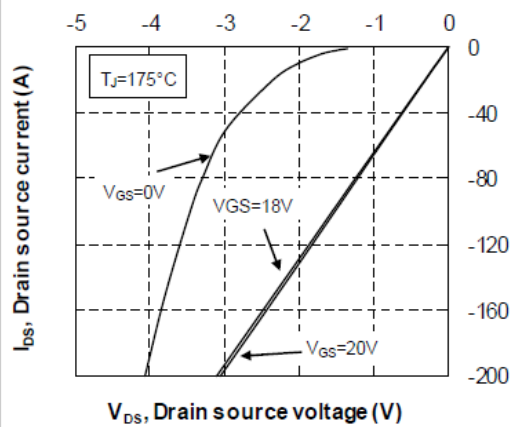
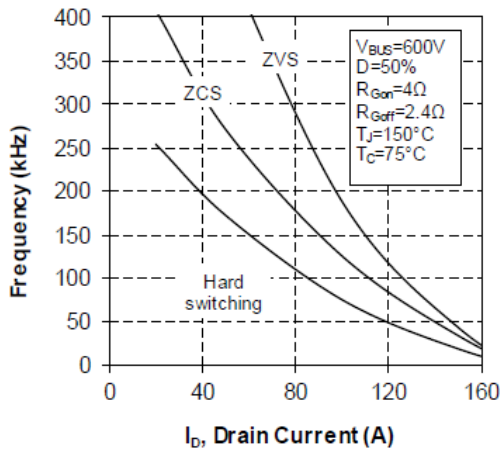

Figure 16 • Operating Frequency vs. Drain Current



3.5 Typical SiC Diode Performance Curves

This sections shows the typical SiC diode performance curves of the MSCSM120HM16CT3AG device.

Figure 17 • Maximum Thermal Impedance

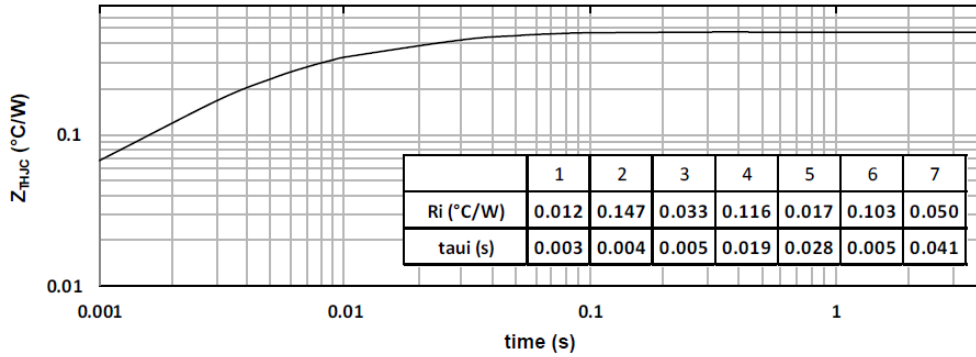

Figure 18 • Forward Characteristics

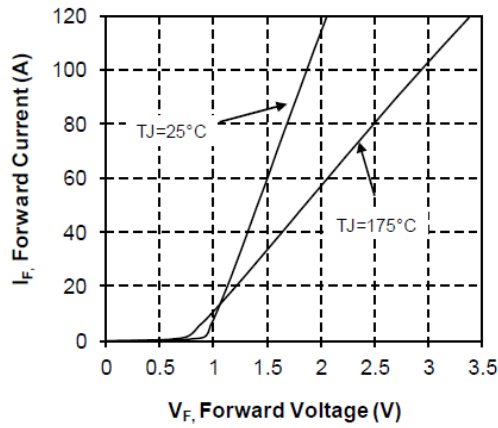
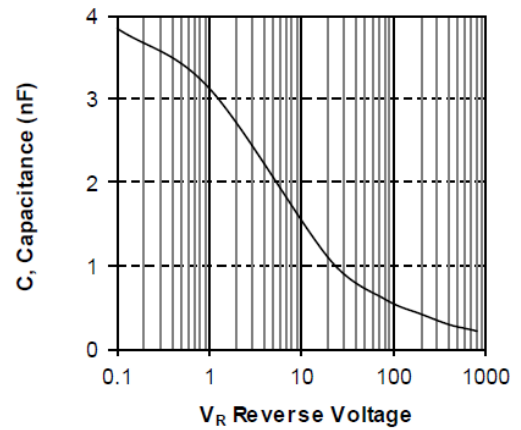

Figure 19 • Capacitance vs. Reverse Voltage



4 Package Specifications

This section shows the package specifications of the MSCSM120HM16CT3AG device.

4.1 Package Outline Drawing

The following figure illustrates the package outline of the MSCSM120HM16CT3AG device. The dimensions are in millimeters.

Figure 20 • Package Outline Drawing

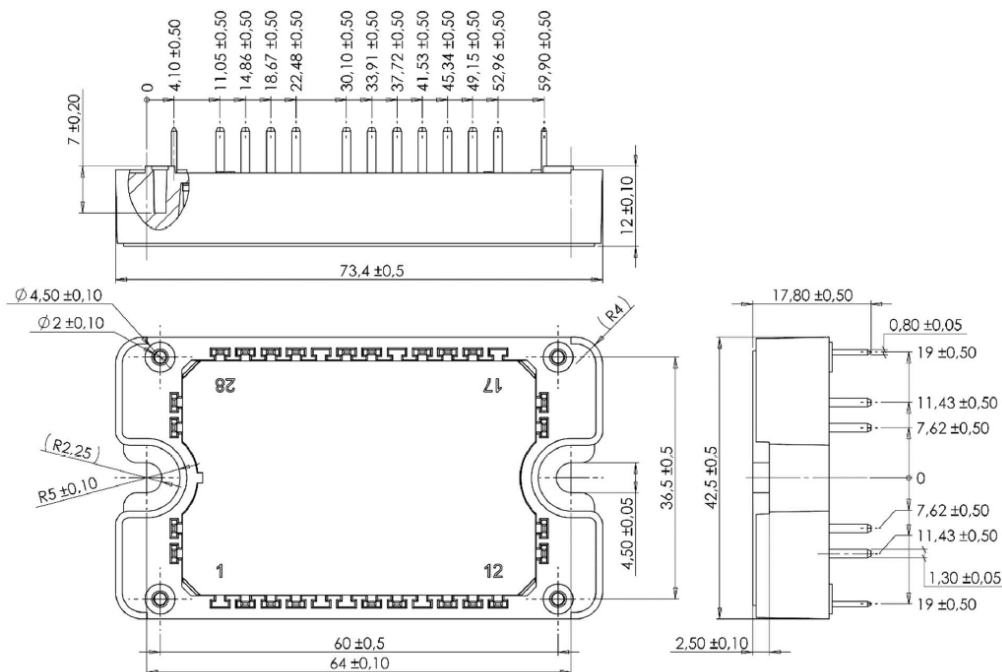

Note: See application note [1906—Mounting Instructions for SP3F Power Modules](#) on www.microsemi.com

**Microsemi**

2355 W. Chandler Blvd.
 Chandler, AZ 85224 USA

Within the USA: +1 (480) 792-7200
 Fax: +1 (480) 792-7277

www.microsemi.com © 2020 Microsemi and its corporate affiliates. All rights reserved. Microsemi and the Microsemi logo are trademarks of Microsemi Corporation and its corporate affiliates. All other trademarks and service marks are the property of their respective owners.

Microsemi's product warranty is set forth in Microsemi's Sales Order Terms and Conditions. Information contained in this publication is provided for the sole purpose of designing with and using Microsemi products. Information regarding device applications and the like is provided only for your convenience and may be superseded by updates. Buyer shall not rely on any data and performance specifications or parameters provided by Microsemi. It is your responsibility to ensure that your application meets with your specifications. THIS INFORMATION IS PROVIDED "AS IS." MICROSEMI MAKES NO REPRESENTATIONS OR WARRANTIES OF ANY KIND WHETHER EXPRESS OR IMPLIED, WRITTEN OR ORAL, STATUTORY OR OTHERWISE, RELATED TO THE INFORMATION, INCLUDING BUT NOT LIMITED TO ITS CONDITION, QUALITY, PERFORMANCE, NON-INFRINGEMENT, MERCHANTABILITY OR FITNESS FOR A PARTICULAR PURPOSE. IN NO EVENT WILL MICROSEMI BE LIABLE FOR ANY INDIRECT, SPECIAL, PUNITIVE, INCIDENTAL OR CONSEQUENTIAL LOSS, DAMAGE, COST OR EXPENSE WHATSOEVER RELATED TO THIS INFORMATION OR ITS USE, HOWEVER CAUSED, EVEN IF MICROSEMI HAS BEEN ADVISED OF THE POSSIBILITY OR THE DAMAGES ARE FORESEEABLE. TO THE FULLEST EXTENT ALLOWED BY LAW, MICROSEMI'S TOTAL LIABILITY ON ALL CLAIMS IN RELATED TO THIS INFORMATION OR ITS USE WILL NOT EXCEED THE AMOUNT OF FEES, IF ANY, YOU PAID DIRECTLY TO MICROSEMI FOR THIS INFORMATION. Use of Microsemi devices in life support, mission-critical equipment or applications, and/or safety applications is entirely at the buyer's risk, and the buyer agrees to defend and indemnify Microsemi from any and all damages, claims, suits, or expenses resulting from such use. No licenses are conveyed, implicitly or otherwise, under any Microsemi intellectual property rights unless otherwise stated.

Microsemi Corporation, a subsidiary of Microchip Technology Inc. (Nasdaq: MCHP), and its corporate affiliates are leading providers of smart, connected and secure embedded control solutions. Their easy-to-use development tools and comprehensive product portfolio enable customers to create optimal designs which reduce risk while lowering total system cost and time to market. These solutions serve more than 120,000 customers across the industrial, automotive, consumer, aerospace and defense, communications and computing markets. Headquartered in Chandler, Arizona, the company offers outstanding technical support along with dependable delivery and quality. Learn more at www.microsemi.com.

MSCC-0344-DS-01060-1.0-0120

Mouser Electronics

Authorized Distributor

Click to View Pricing, Inventory, Delivery & Lifecycle Information:

[Microchip:](#)

[MSCSM120HM16CT3AG](#)