



# RF Power LDMOS Transistors

## High Ruggedness N-Channel Enhancement-Mode Lateral MOSFETs

These high ruggedness devices are designed for use in high VSWR industrial, scientific and medical applications, as well as radio and VHF TV broadcast, sub-GHz aerospace and mobile radio applications. Their unmatched input and output design allows for wide frequency range use from 1.8 to 500 MHz.

**Typical Performance:**  $V_{DD} = 50$  Vdc

Frequency (MHz)	Signal Type	$P_{out}$ (W)	$G_{ps}$ (dB)	$\eta_D$ (%)
87.5–108 (1,2)	CW	1421 CW	23.1	83.2
230 (3,4)	Pulse (100 $\mu$ sec, 20% Duty Cycle)	1500 Peak	23.4	75.1

### Load Mismatch/Ruggedness

Frequency (MHz)	Signal Type	VSWR	$P_{in}$ (W)	Test Voltage	Result
230 (3)	Pulse (100 $\mu$ sec, 20% Duty Cycle)	> 65:1 at all Phase Angles	15 Peak (3 dB Overdrive)	50	No Device Degradation

1. Data from 87.5–108 MHz broadband reference circuit (page 5).
2. The values shown are the center band performance numbers across the indicated frequency range.
3. Data from 230 MHz narrowband production test fixture (page 11).
4. All data measured in fixture with device soldered to heatsink.

### Features

- High drain-source avalanche energy absorption capability
- Unmatched input and output allowing wide frequency range utilization
- Device can be used single-ended or in a push-pull configuration
- Characterized from 30 to 50 V for ease of use
- Suitable for linear application
- Integrated ESD protection with greater negative gate-source voltage range for improved Class C operation
- Recommended driver: MRFE6VS25N (25 W)

### Typical Applications

- Industrial, Scientific, Medical (ISM)
  - Laser generation
  - Plasma etching
  - Particle accelerators
  - MRI and other medical applications
  - Industrial heating, welding and drying systems
- Broadcast
  - Radio broadcast
  - VHF TV broadcast
- Aerospace
  - VHF omnidirectional range (VOR)
  - HF and VHF communications
  - Weather radar
- Mobile Radio
  - VHF and UHF base stations

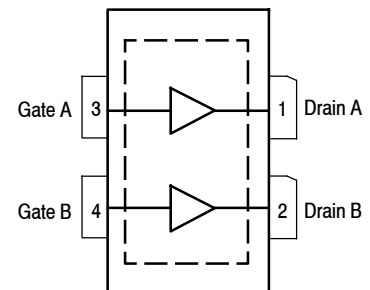
**MRF1K50N**  
**MRF1K50GN**

**1.8–500 MHz, 1500 W CW, 50 V**  
**WIDEBAND**  
**RF POWER LDMOS TRANSISTORS**

**OM-1230-4L**  
**PLASTIC**  
**MRF1K50N**



**OM-1230G-4L**  
**PLASTIC**  
**MRF1K50GN**



(Top View)

Note: Exposed backside of the package is the source terminal for the transistor.

**Figure 1. Pin Connections**



**Table 1. Maximum Ratings**

Rating	Symbol	Value	Unit
Drain-Source Voltage	$V_{DSS}$	-0.5, +133	Vdc
Gate-Source Voltage	$V_{GS}$	-6.0, +10	Vdc
Operating Voltage	$V_{DD}$	50	Vdc
Storage Temperature Range	$T_{stg}$	-65 to +150	°C
Case Operating Temperature Range	$T_C$	-40 to +150	°C
Operating Junction Temperature Range (1,2)	$T_J$	-40 to +225	°C
Total Device Dissipation @ $T_C = 25^\circ\text{C}$ Derate above 25°C	$P_D$	2941 14.71	W W/°C

**Table 2. Thermal Characteristics**

Characteristic	Symbol	Value (2,3)	Unit
Thermal Resistance, Junction to Case CW: Case Temperature 80°C, 1500 W CW, 50 Vdc, $I_{DQ(A+B)} = 200$ mA, 98 MHz	$R_{\theta JC}$	0.068	°C/W
Thermal Impedance, Junction to Case Pulse: Case Temperature 75°C, 1500 W Peak, 100 $\mu\text{sec}$ Pulse Width, 20% Duty Cycle, 50 Vdc, $I_{DQ(A+B)} = 100$ mA, 230 MHz	$Z_{\theta JC}$	0.015	°C/W

**Table 3. ESD Protection Characteristics**

Test Methodology	Class
Human Body Model (per JESD22-A114)	2, passes 2500 V
Charge Device Model (per JESD22-C101)	C3, passes 2000 V

**Table 4. Moisture Sensitivity Level**

Test Methodology	Rating	Package Peak Temperature	Unit
Per JESD22-A113, IPC/JEDEC J-STD-020	3	260	°C

**Table 5. Electrical Characteristics** ( $T_A = 25^\circ\text{C}$  unless otherwise noted)

Characteristic	Symbol	Min	Typ	Max	Unit
----------------	--------	-----	-----	-----	------

**Off Characteristics (4)**

Gate-Source Leakage Current ( $V_{GS} = 5$ Vdc, $V_{DS} = 0$ Vdc)	$I_{GSS}$	—	—	1	$\mu\text{Adc}$
Drain-Source Breakdown Voltage ( $V_{GS} = 0$ Vdc, $I_D = 100$ mAdc)	$V_{(BR)DSS}$	133	—	—	Vdc
Zero Gate Voltage Drain Leakage Current ( $V_{DS} = 50$ Vdc, $V_{GS} = 0$ Vdc)	$I_{DSS}$	—	—	10	$\mu\text{Adc}$
Zero Gate Voltage Drain Leakage Current ( $V_{DS} = 133$ Vdc, $V_{GS} = 0$ Vdc)	$I_{DSS}$	—	—	100	mAdc

**On Characteristics**

Gate Threshold Voltage (4) ( $V_{DS} = 10$ Vdc, $I_D = 2130$ $\mu\text{Adc}$ )	$V_{GS(th)}$	1.7	2.2	2.7	Vdc
Gate Quiescent Voltage ( $V_{DD} = 50$ Vdc, $I_{D(A+B)} = 100$ mAdc, Measured in Functional Test)	$V_{GS(Q)}$	1.9	2.4	2.9	Vdc
Drain-Source On-Voltage (4) ( $V_{GS} = 10$ Vdc, $I_D = 2.4$ Adc)	$V_{DS(on)}$	—	0.15	—	Vdc
Forward Transconductance (4) ( $V_{DS} = 10$ Vdc, $I_D = 36$ Adc)	$g_{fs}$	—	33.5	—	S

1. Continuous use at maximum temperature will affect MTTF.
2. MTTF calculator available at <http://www.nxp.com/RF/calculators>.
3. Refer to AN1955, *Thermal Measurement Methodology of RF Power Amplifiers*. Go to <http://www.nxp.com/RF> and search for AN1955.
4. Each side of device measured separately.

(continued)

**Table 5. Electrical Characteristics** ( $T_A = 25^\circ\text{C}$  unless otherwise noted) (continued)

Characteristic	Symbol	Min	Typ	Max	Unit
<b>Dynamic Characteristics</b> <sup>(1)</sup>					
Reverse Transfer Capacitance ( $V_{DS} = 50\text{ Vdc} \pm 30\text{ mV(rms)ac}$ @ 1 MHz, $V_{GS} = 0\text{ Vdc}$ )	$C_{rss}$	—	5.77	—	pF
Output Capacitance ( $V_{DS} = 50\text{ Vdc} \pm 30\text{ mV(rms)ac}$ @ 1 MHz, $V_{GS} = 0\text{ Vdc}$ )	$C_{oss}$	—	219	—	pF
Input Capacitance ( $V_{DS} = 50\text{ Vdc}$ , $V_{GS} = 0\text{ Vdc} \pm 30\text{ mV(rms)ac}$ @ 1 MHz)	$C_{iss}$	—	683	—	pF

**Functional Tests** <sup>(2,3)</sup> (In NXP Production Test Fixture, 50 ohm system)  $V_{DD} = 50\text{ Vdc}$ ,  $I_{DQ(A+B)} = 100\text{ mA}$ ,  $P_{out} = 1500\text{ W Peak}$  (300 W Avg.),  $f = 230\text{ MHz}$ , 100  $\mu\text{sec}$  Pulse Width, 20% Duty Cycle

Power Gain	$G_{ps}$	21.5	23.0	25.0	dB
Drain Efficiency	$\eta_D$	68.0	73.0	—	%
Input Return Loss	IRL	—	-16	-9	dB

**Table 6. Load Mismatch/Ruggedness** (In NXP Production Test Fixture, 50 ohm system)  $I_{DQ(A+B)} = 100\text{ mA}$ 

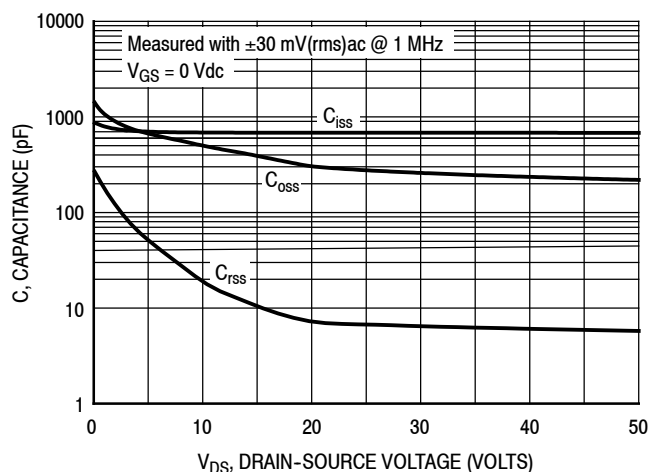
Frequency (MHz)	Signal Type	VSWR	$P_{in}$ (W)	Test Voltage, $V_{DD}$	Result
230	Pulse (100 $\mu\text{sec}$ , 20% Duty Cycle)	> 65:1 at all Phase Angles	15 Peak (3 dB Overdrive)	50	No Device Degradation

**Table 7. Ordering Information**

Device	Tape and Reel Information	Package
MRF1K50NR5	R5 Suffix = 50 Units, 56 mm Tape Width, 13-inch Reel	OM-1230-4L
MRF1K50GNR5		OM-1230G-4L

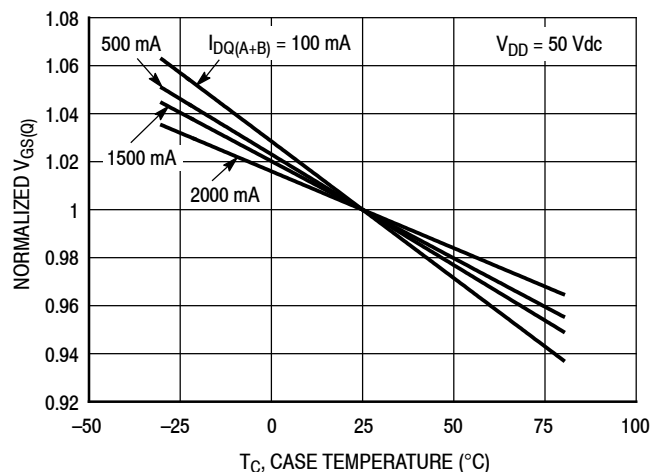
- Each side of device measured separately.
- Devices tested without thermal grease or solder under the transistor.
- Measurements made with device in straight lead configuration before any lead forming operation is applied. Lead forming is used for gull wing (GN) parts.

## TYPICAL CHARACTERISTICS



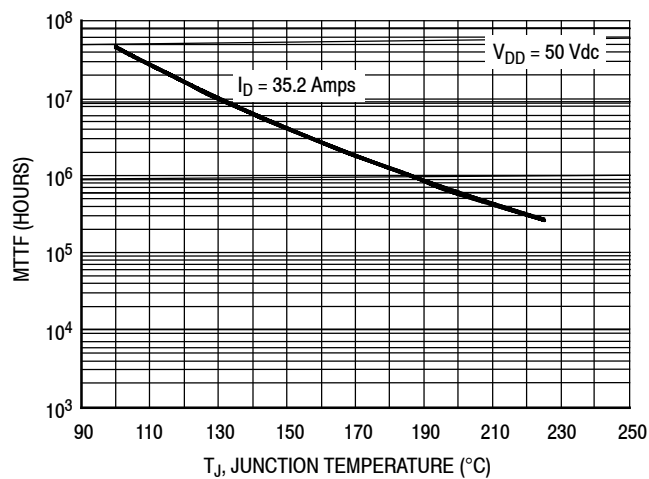
**Note:** Each side of device measured separately.

**Figure 2. Capacitance versus Drain-Source Voltage**



$I_{DQ}$ (mA)	Slope (mV/°C)
100	-2.76
500	-2.38
1500	-2.20
2000	-1.76

**Figure 3. Normalized  $V_{GS}$  versus Quiescent Current and Case Temperature**



**Note:** MTTF value represents the total cumulative operating time under indicated test conditions.

MTTF calculator available at <http://www.nxp.com/RF/calculators>.

**Figure 4. MTTF versus Junction Temperature — CW**

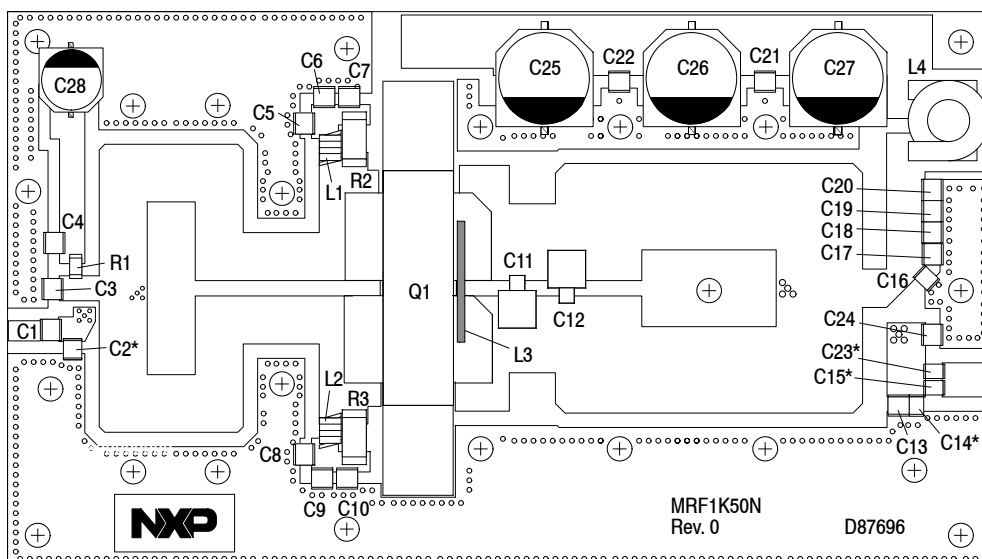
## 87.5–108 MHz BROADBAND REFERENCE CIRCUIT

**Table 8. 87.5–108 MHz Broadband Performance** (In NXP Reference Circuit, 50 ohm system)

$V_{DD} = 50$  Vdc,  $I_{DQ(A+B)} = 200$  mA,  $P_{in} = 7$  W, CW

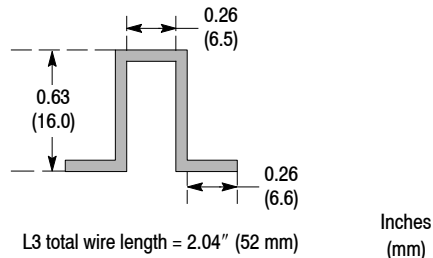
Frequency (MHz)	$G_{ps}$ (dB)	$\eta_D$ (%)	$P_{out}$ (W)
87.5	22.5	81.7	1257
98	23.1	83.2	1421
108	22.8	79.1	1328

## 87.5–108 MHz BROADBAND REFERENCE CIRCUIT — 2.88" × 5.12" (73 mm × 130 mm)

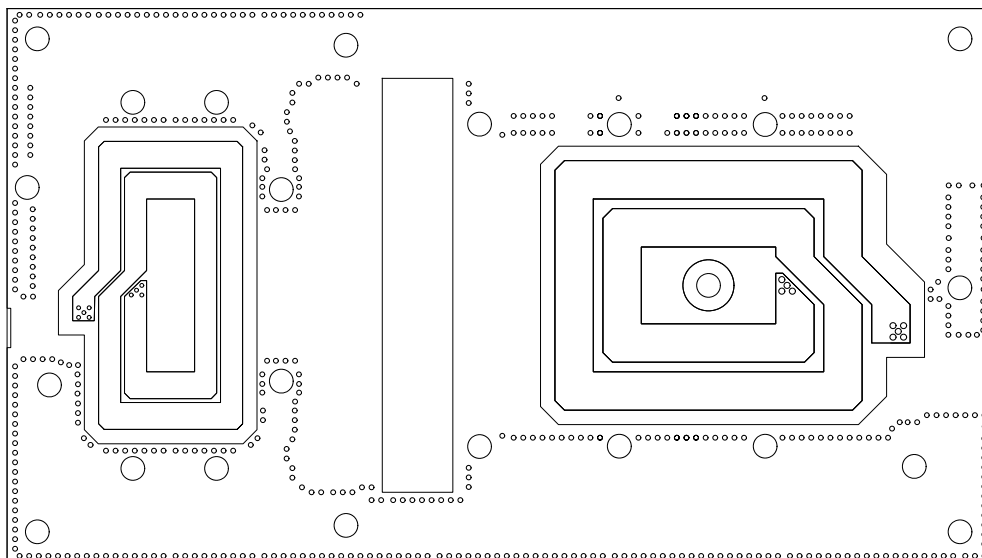


\*C2, C14, C15 and C23 are mounted vertically.

Note: Q1 leads are soldered to the PCB with L3 soldered directly on top of the drain leads.



**Figure 5. MRF1K50N 87.5–108 MHz Broadband Reference Circuit Component Layout**



**Figure 6. MRF1K50N 87.5–108 MHz Broadband Reference Circuit Component Layout — Bottom**

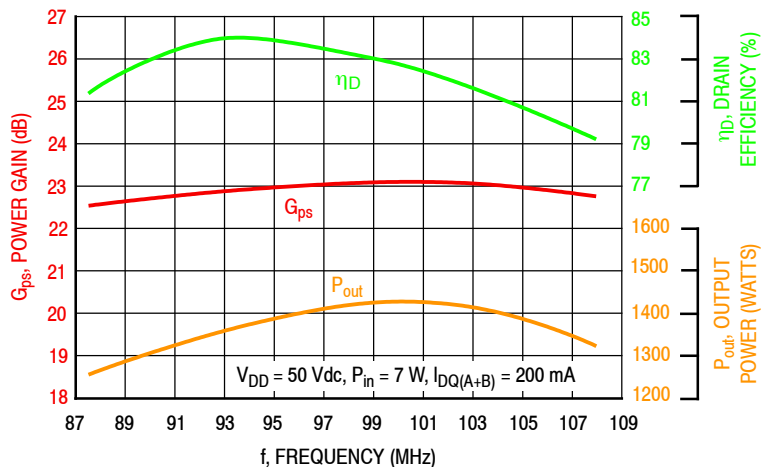
## 87.5–108 MHz BROADBAND REFERENCE CIRCUIT

**Table 9. MRF1K50N Broadband Reference Circuit Component Designations and Values — 87.5–108 MHz**

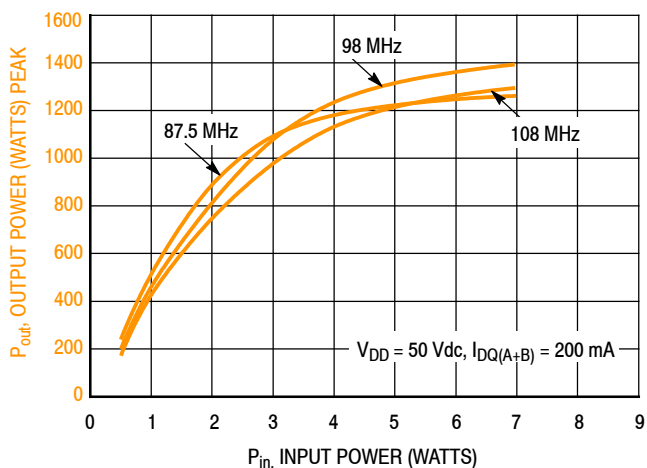
Part	Description	Part Number	Manufacturer
C1, C3, C6, C9, C18, C19, C20, C21, C22	1000 pF Chip Capacitors	ATC100B102JT50XT	ATC
C2	33 pF Chip Capacitor	ATC100B330JT500XT	ATC
C4, C5, C8	10,000 pF Chip Capacitors	ATC200B103KT50XT	ATC
C7, C10, C15, C16, C17, C23	470 pF Chip Capacitors	ATC100B471JT200XT	ATC
C11	91 pF, 300 V Mica Capacitor	MIN02-002EC910J-F	CDE
C12	56 pF, 300 V Mica Capacitor	MIN02-002DC560J-F	CDE
C13	2.2 pF Chip Capacitor	ATC100B2R2JT500XT	ATC
C14, C24	12 pF Chip Capacitors	ATC100B120GT500XT	ATC
C25, C26, C27	220 $\mu$ F, 100 V Electrolytic Capacitors	EEV-FK1A221M	Panasonic
C28	22 $\mu$ F, 35 V Electrolytic Capacitor	UUD1V220MCL1GS	Nichicon
L1, L2	17.5 nH Inductors, 6 Turns	B06TJLC	Coilcraft
L3	1.5 mm Non-Tarnish Silver Plated Copper Wire	SP1500NT-001	Scientific Wire Company
L4	22 nH Inductor	1212VS-22NMEB	Coilcraft
Q1	RF Power LD MOS Transistor	MRF1K50N	NXP
R1	10 $\Omega$ , 1/4 W Chip Resistor	CRCW120610R0JNEA	Vishay
R2, R3	33 $\Omega$ , 2 W Chip Resistors	1-2176070-3	TE Connectivity
PCB	Arlon TC350 0.030", $\epsilon_r = 3.5$	D87696	MTL

Note: Refer to MRF1K50N's [printed circuit boards and schematics](#) to download the 87.5–108 MHz heatsink drawing.

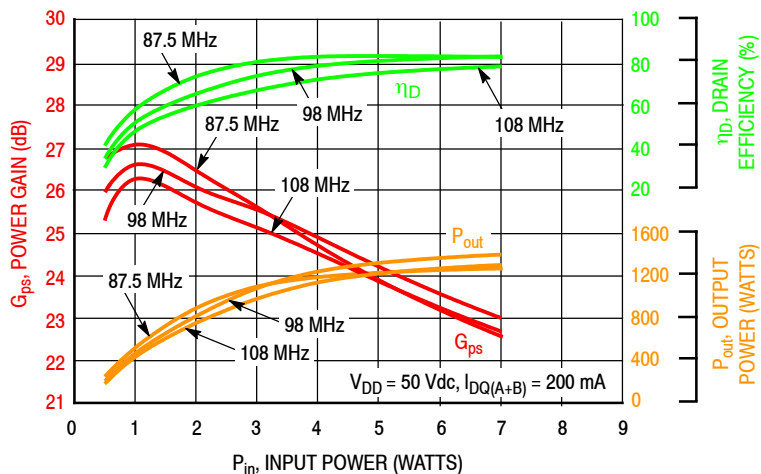
**TYPICAL CHARACTERISTICS — 87.5–108 MHz  
BROADBAND REFERENCE CIRCUIT**



**Figure 7. Power Gain, Drain Efficiency and CW Output Power versus Frequency at a Constant Input Power**



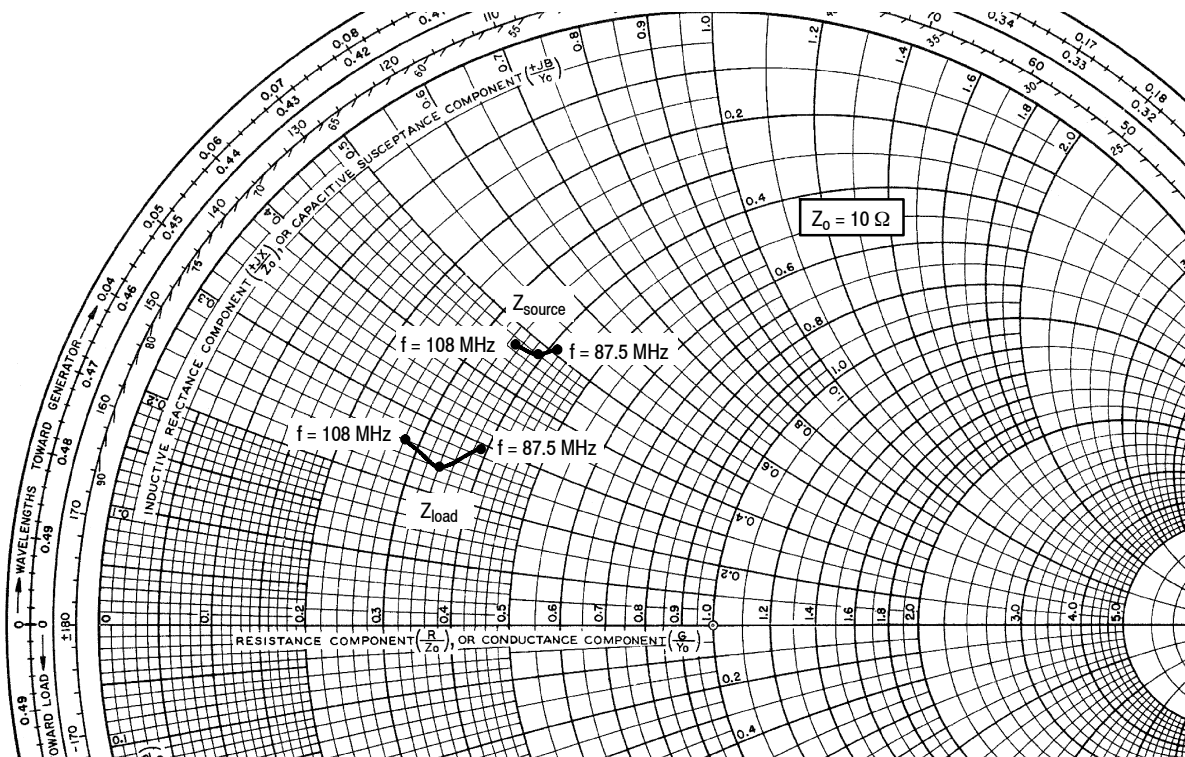
**Figure 8. CW Output Power versus Input Power and Frequency**



**Figure 9. Power Gain, Drain Efficiency and CW Output Power versus Input Power and Frequency**



### 87.5–108 MHz BROADBAND REFERENCE CIRCUIT



f MHz	Z <sub>source</sub> Ω	Z <sub>load</sub> Ω
87.5	4.07 + j5.13	3.92 + j2.89
98	3.93 + j4.84	3.39 + j2.35
108	3.50 + j4.72	2.83 + j2.56

Z<sub>source</sub> = Test circuit impedance as measured from gate to gate, balanced configuration.

Z<sub>load</sub> = Test circuit impedance as measured from drain to drain, balanced configuration.

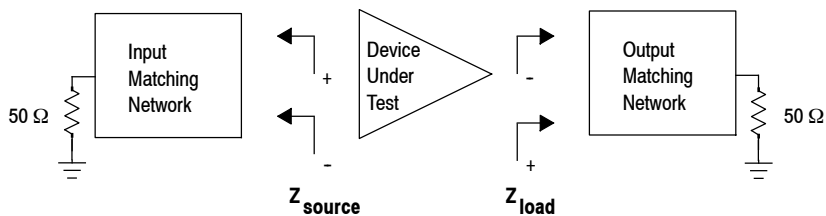
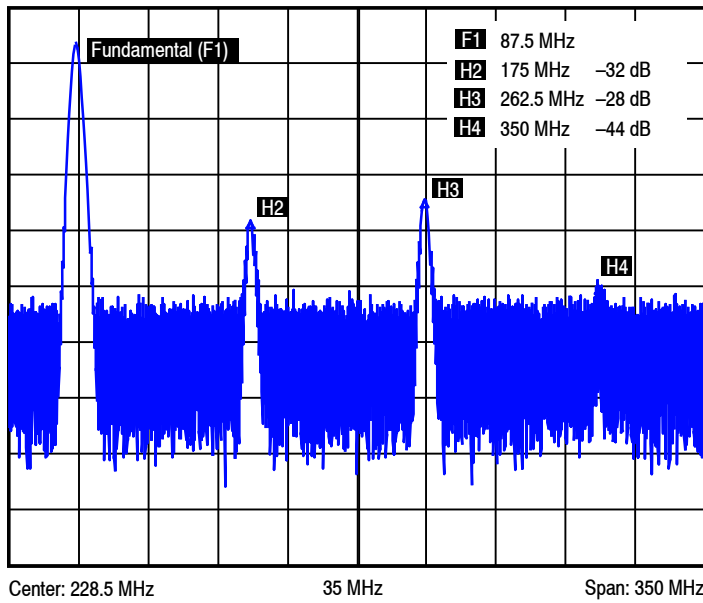


Figure 10. Broadband Series Equivalent Source and Load Impedance — 87.5–108 MHz

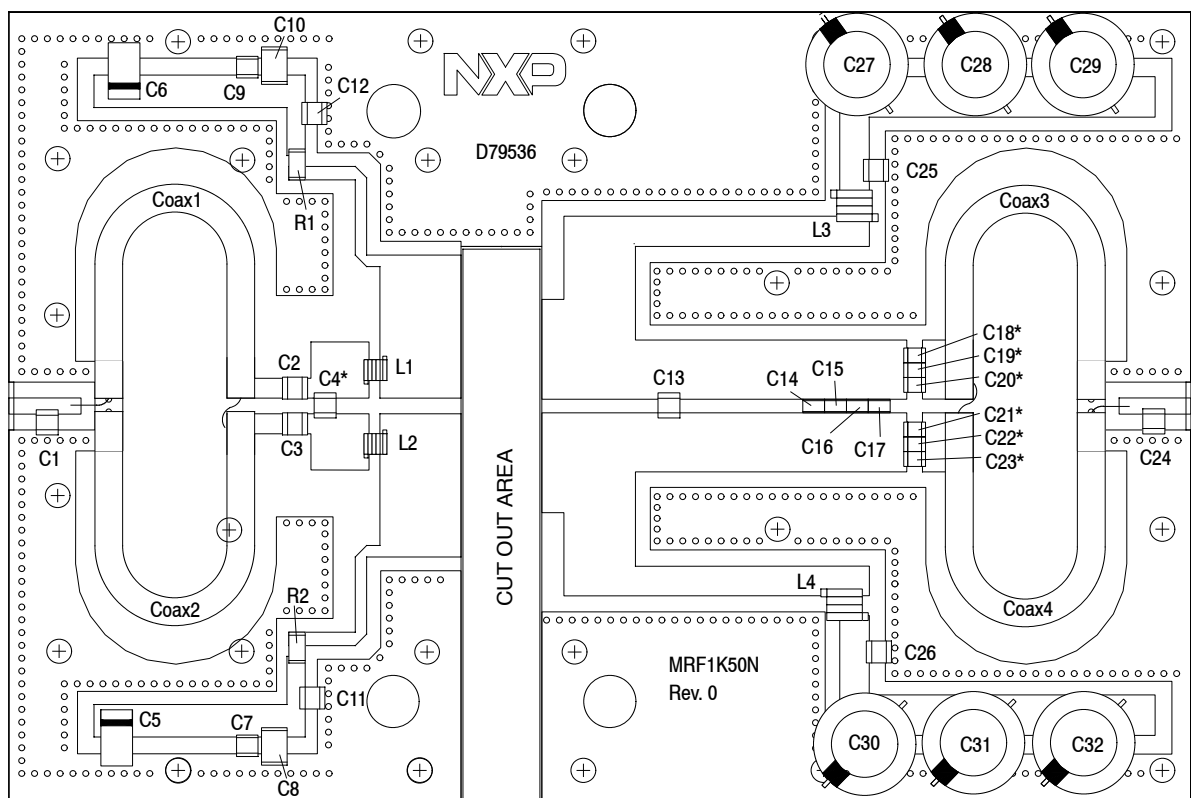
**HARMONIC MEASUREMENTS — 87.5–108 MHz  
BROADBAND REFERENCE CIRCUIT**



H2 (175 MHz)	H3 (262.5 MHz)	H4 (350 MHz)
-32 dB	-28 dB	-44 dB

**Figure 11. 87.5 MHz Harmonics @ 1200 W CW**

230 MHz NARROWBAND PRODUCTION TEST FIXTURE — 6.0" x 4.0" (152 mm x 102 mm)



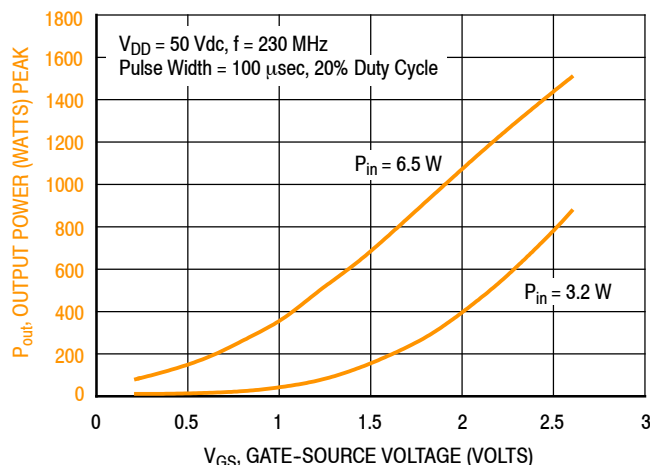
\*C4, C18, C19, C20, C21, C22 and C23 are mounted vertically.

Figure 12. MRF1K50N Narrowband Test Circuit Component Layout — 230 MHz

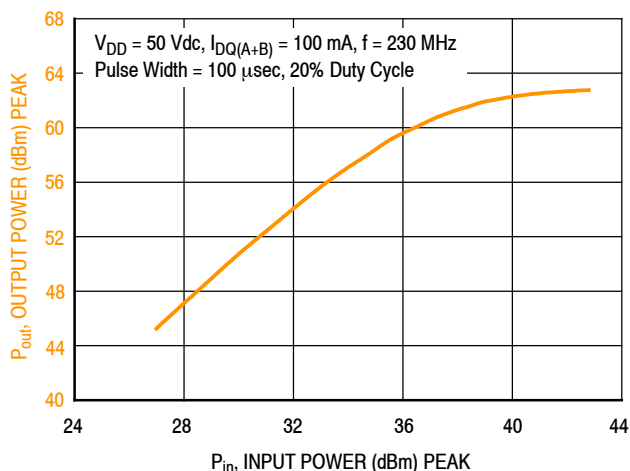
Table 10. MRF1K50N Narrowband Test Circuit Component Designations and Values — 230 MHz

Part	Description	Part Number	Manufacturer
C1, C2, C3	22 pF Chip Capacitors	ATC100B220JT500XT	ATC
C4	27 pF Chip Capacitor	ATC100B270JT500XT	ATC
C5, C6	22 $\mu$ F, 35 V Tantalum Capacitors	T491X226K035AT	Kemet
C7, C9	0.1 $\mu$ F Chip Capacitors	CDR33BX104AKWS	AVX
C8, C10	220 nF Chip Capacitors	C1812C224K5RACTU	Kemet
C11, C12, C25, C26	1000 pF Chip Capacitors	ATC100B102JT50XT	ATC
C13	51 pF Chip Capacitor	ATC100B510JT500XT	ATC
C14	24 pF Chip Capacitor	ATC800R240JT500XT	ATC
C15, C16, C17	20 pF Chip Capacitors	ATC800R200JT500XT	ATC
C18, C19, C20, C21, C22, C23	240 pF Chip Capacitors	ATC100B241JT200XT	ATC
C24	8.2 pF Chip Capacitor	ATC100B8R2CT500XT	ATC
C27, C28, C29, C30, C31, C32	470 $\mu$ F, 63 V Electrolytic Capacitors	MCGPR63V477M13X26-RH	Multicomp
Coax1, 2, 3, 4	25 $\Omega$ Semi Rigid Coax Cables, 2.2" Shield Length	UT-141C-25	Micro-Coax
L1, L2	5 nH Inductors	A02TKLC	Coilcraft
L3, L4	6.6 nH Inductors	GA3093-ALC	Coilcraft
R1, R2	10 $\Omega$ , 1/4 W Chip Resistors	CRCW120610R0JNEA	Vishay
PCB	Arlon AD255A 0.030", $\epsilon_r = 2.55$	D79536	MTL

## TYPICAL CHARACTERISTICS — 230 MHz PRODUCTION TEST FIXTURE

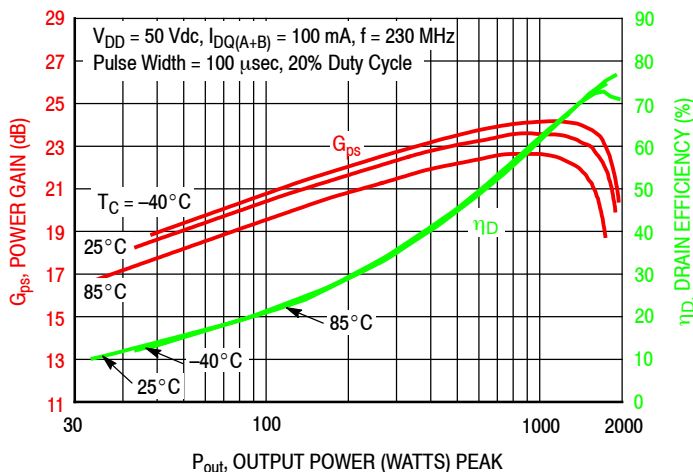


**Figure 13. Output Power versus Gate-Source Voltage at a Constant Input Power**

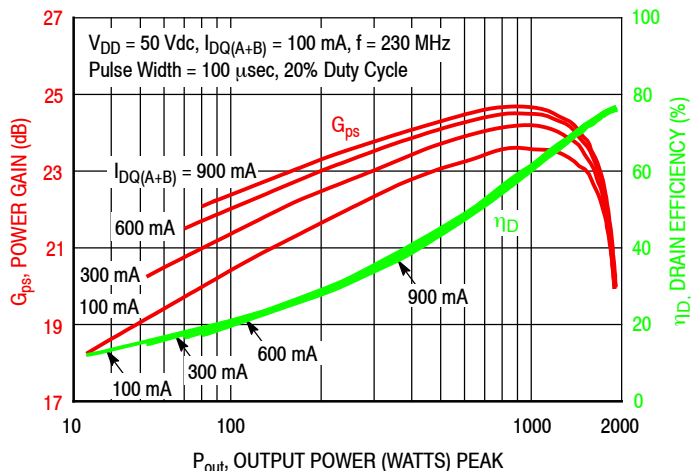


f (MHz)	P1dB (W)	P3dB (W)
230	1629	1857

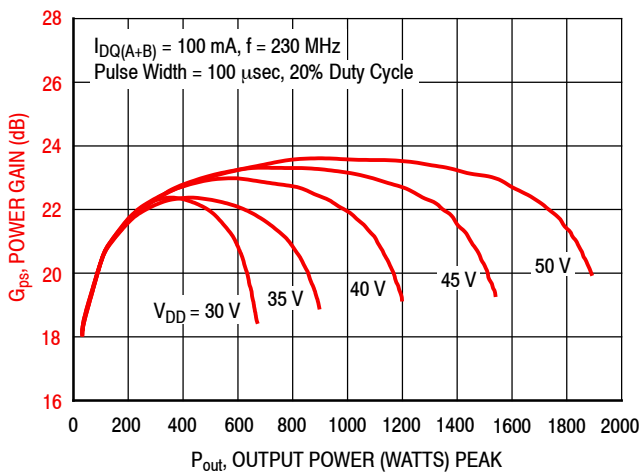
**Figure 14. Output Power versus Input Power**



**Figure 16. Power Gain and Drain Efficiency versus Output Power**



**Figure 15. Power Gain and Drain Efficiency versus Output Power and Quiescent Current**



**Figure 17. Power Gain versus Output Power and Drain-Source Voltage**

## 230 MHz NARROWBAND PRODUCTION TEST FIXTURE

f MHz	$Z_{\text{source}}$ $\Omega$	$Z_{\text{load}}$ $\Omega$
230	$1.0 + j2.0$	$1.7 + j0.9$

$Z_{\text{source}}$  = Test circuit impedance as measured from gate to gate, balanced configuration.

$Z_{\text{load}}$  = Test circuit impedance as measured from drain to drain, balanced configuration.

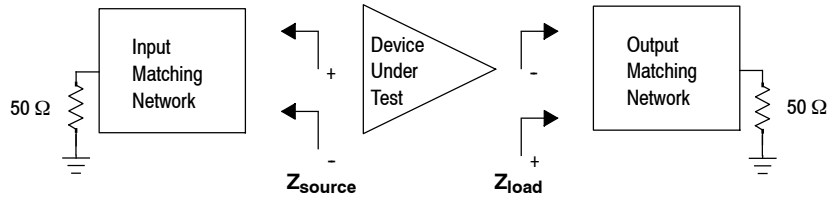


Figure 18. Narrowband Series Equivalent Source and Load Impedance — 230 MHz

# PACKAGE DIMENSIONS



© NXP SEMICONDUCTORS N.V. ALL RIGHTS RESERVED	MECHANICAL OUTLINE	PRINT VERSION NOT TO SCALE
TITLE:  OM-1230-4L	DOCUMENT NO: 98ASA00506D	REV: C
	STANDARD: NON-JEDEC	
	SOT1816-1	08 FEB 2016



PIN 5

BOTTOM VIEW  
 VIEW G-G

© NXP SEMICONDUCTORS N.V. ALL RIGHTS RESERVED	MECHANICAL OUTLINE	PRINT VERSION NOT TO SCALE	
TITLE:  OM-1230-4L	DOCUMENT NO: 98ASA00506D		REV: C
	STANDARD: NON-JEDEC		
	SOT1816-1	08 FEB 2016	

NOTES:

1. CONTROLLING DIMENSION: INCH
2. INTERPRET DIMENSIONS AND TOLERANCES PER ASME Y14.5M-1994.
3. DATUM PLANE H IS LOCATED AT TOP OF LEAD AND IS COINCIDENT WITH THE LEAD WHERE THE LEAD EXITS THE PLASTIC BODY AT THE TOP OF THE PARTING LINE.
4. DIMENSIONS DD AND E1 DO NOT INCLUDE MOLD PROTRUSION. ALLOWABLE PROTRUSION IS .006 INCH (0.15 MM) PER SIDE. DIMENSIONS DD AND E1 DO INCLUDE MOLD MISMATCH AND ARE DETERMINED AT DATUM PLANE H.
5. DIMENSION bb DOES NOT INCLUDE DAMBAR PROTRUSION. ALLOWABLE DAMBAR PROTRUSION SHALL BE .005 INCH (0.13 MM) TOTAL IN EXCESS OF THE bb DIMENSION AT MAXIMUM MATERIAL CONDITION.
6. DATUMS A AND B TO BE DETERMINED AT DATUM PLANE H.
7. DIMENSION A1 APPLIES WITHIN ZONE J ONLY.
8. HATCHING REPRESENTS THE EXPOSED AREA OF THE HEAT SLUG. THE DIMENSIONS D1 AND E2 REPRESENT THE VALUES BETWEEN THE TWO OPPOSITE POINTS ALONG THE EDGES OF EXPOSED AREA OF HEAT SLUG.
9. DIMPLED HOLE REPRESENTS INPUT SIDE.

DIM	INCH		MILLIMETER		DIM	INCH		MILLIMETER	
	MIN	MAX	MIN	MAX		MIN	MAX	MIN	MAX
AA	.148	.152	3.76	3.86	bb	.457	.463	11.61	11.76
A1	.059	.065	1.50	1.65	c1	.007	.011	0.18	0.28
DD	1.267	1.273	32.18	32.33	e	.270 BSC		6.86 BSC	
D1	1.180	----	29.97	----	e1	.116	.124	2.95	3.15
E	.762	.770	19.35	19.56					
E1	.390	.394	9.91	10.01	aaa	.004		0.10	
E2	.306	----	7.77	----	bbb	.006		0.15	
E3	.383	.387	9.73	9.83	ccc	.010		0.25	
F	.025 BSC		0.635 BSC						

© NXP SEMICONDUCTORS N.V. ALL RIGHTS RESERVED		MECHANICAL OUTLINE	PRINT VERSION NOT TO SCALE
TITLE:  OM-1230-4L		DOCUMENT NO: 98ASA00506D      REV: C	
		STANDARD: NON-JEDEC	
		SOT1816-1	08 FEB 2016





© NXP SEMICONDUCTORS N.V. ALL RIGHTS RESERVED	MECHANICAL OUTLINE	PRINT VERSION NOT TO SCALE	
TITLE:  OM-1230G-4L	DOCUMENT NO: 98ASA00818D		REV: B
	STANDARD: NON-JEDEC		
	SOT1824-1	18 FEB 2016	



© NXP SEMICONDUCTORS N.V. ALL RIGHTS RESERVED	MECHANICAL OUTLINE	PRINT VERSION NOT TO SCALE
TITLE:  OM-1230G-4L	DOCUMENT NO: 98ASA00818D	REV: B
	STANDARD: NON-JEDEC	
	SOT1824-1	18 FEB 2016

NOTES:

1. CONTROLLING DIMENSION: INCH
2. INTERPRET DIMENSIONS AND TOLERANCES PER ASME Y14.5M-1994.
3. DATUM PLANE H IS LOCATED AT TOP OF LEAD AND IS COINCIDENT WITH THE LEAD WHERE THE LEAD EXITS THE PLASTIC BODY AT THE TOP OF THE PARTING LINE.
4. DIMENSIONS DD AND E1 DO NOT INCLUDE MOLD PROTRUSION. ALLOWABLE PROTRUSION IS .006 INCH (0.15 MM) PER SIDE. DIMENSIONS DD AND E1 DO INCLUDE MOLD MISMATCH AND ARE DETERMINED AT DATUM PLANE H.
5. DIMENSION bb DOES NOT INCLUDE DAMBAR PROTRUSION. ALLOWABLE DAMBAR PROTRUSION SHALL BE .005 INCH (0.13 MM) TOTAL IN EXCESS OF THE bb DIMENSION AT MAXIMUM MATERIAL CONDITION.
6. DATUMS A AND B TO BE DETERMINED AT DATUM PLANE H.
7. HATCHING REPRESENTS THE EXPOSED AND SOLDERABLE AREA OF THE HEAT SLUG. THE DIMENSIONS D1 AND E2 REPRESENT THE VALUES BETWEEN THE TWO OPPOSITE POINTS ALONG THE EDGES OF EXPOSED AREA OF HEAT SLUG.
8. DIMPLED HOLE REPRESENTS INPUT SIDE.
9. DIMENSION A1 IS MEASURED WITH REFERENCE TO DATUM D. THE POSITIVE VALUE IMPLIES THAT THE BOTTOM OF THE PACKAGE IS HIGHER THAN THE BOTTOM OF THE LEAD.

DIM	INCH		MILLIMETER		DIM	INCH		MILLIMETER	
	MIN	MAX	MIN	MAX		MIN	MAX	MIN	MAX
AA	.148	.152	3.76	3.86	bb	.457	.463	11.61	11.76
A1	-.003	.003	-0.08	0.08	c1	.007	.011	0.18	0.28
DD	1.267	1.273	32.18	32.33	e	.270 BSC		6.86 BSC	
D1	1.180	----	29.97	----	e1	.116	.124	2.95	3.15
E	.563	.575	14.30	14.61	θ	0°	8°	0°	8°
E1	.390	.394	9.91	10.01	aaa	.004		0.10	
E2	.306	----	7.77	----	bbb	.006		0.15	
E3	.383	.387	9.73	9.83	ccc	.010		0.25	
L	.034	.046	0.86	1.17					
L1	.010 BSC		0.25 BSC						

© NXP SEMICONDUCTORS N.V. ALL RIGHTS RESERVED		MECHANICAL OUTLINE	PRINT VERSION NOT TO SCALE
TITLE:  OM-1230G-4L		DOCUMENT NO: 98ASA00818D      REV: B	
		STANDARD: NON-JEDEC	
		SOT1824-1	18 FEB 2016

## PRODUCT DOCUMENTATION, SOFTWARE AND TOOLS

Refer to the following resources to aid your design process.

### Application Notes

- AN1907: Solder Reflow Attach Method for High Power RF Devices in Over-Molded Plastic Packages
- AN1955: Thermal Measurement Methodology of RF Power Amplifiers

### Engineering Bulletins

- EB212: Using Data Sheet Impedances for RF LDMOS Devices

### Software

- Electromigration MTTF Calculator
- RF High Power Model
- .s2p File

### Development Tools

- Printed Circuit Boards

### To Download Resources Specific to a Given Part Number:

1. Go to <http://www.nxp.com/RF>
2. Search by part number
3. Click part number link
4. Choose the desired resource from the drop down menu

## REVISION HISTORY

The following table summarizes revisions to this document.

Revision	Date	Description
0	Nov. 2016	• Initial Release of Data Sheet

---

### ***How to Reach Us:***

**Home Page:**  
nxp.com

**Web Support:**  
nxp.com/support

Information in this document is provided solely to enable system and software implementers to use NXP products. There are no express or implied copyright licenses granted hereunder to design or fabricate any integrated circuits based on the information in this document. NXP reserves the right to make changes without further notice to any products herein.

NXP makes no warranty, representation, or guarantee regarding the suitability of its products for any particular purpose, nor does NXP assume any liability arising out of the application or use of any product or circuit, and specifically disclaims any and all liability, including without limitation consequential or incidental damages. "Typical" parameters that may be provided in NXP data sheets and/or specifications can and do vary in different applications, and actual performance may vary over time. All operating parameters, including "typicals," must be validated for each customer application by customer's technical experts. NXP does not convey any license under its patent rights nor the rights of others. NXP sells products pursuant to standard terms and conditions of sale, which can be found at the following address: [nxp.com/SalesTermsandConditions](http://nxp.com/SalesTermsandConditions).

NXP, the NXP logo, Freescale, and the Freescale logo are trademarks of NXP B.V. All other product or service names are the property of their respective owners.  
© 2016 NXP B.V.



# Mouser Electronics

Authorized Distributor

Click to View Pricing, Inventory, Delivery & Lifecycle Information:

[NXP:](#)

[MRF1K50GNR5](#) [MRF1K50NR5](#) [MRF1K50N-TF4](#) [MRF1K50N-TF1](#)