



RF Power LDMOS Transistors

High Ruggedness N-Channel Enhancement-Mode Lateral MOSFETs

These RF power devices are designed for pulse applications operating at frequencies from 1200 to 1400 MHz. The devices are suitable for use in pulse applications and are ideal for use in high power military and commercial L-Band radar applications.

Typical Performance: In 1200–1400 MHz reference circuit, $V_{DD} = 52$ Vdc, $I_{DQ(A+B)} = 100$ mA

Frequency (MHz)	Signal Type	P_{out} (W)	G_{ps} (dB)	η_D (%)
1200	Pulse (128 μ sec, 10% Duty Cycle)	1130 Peak	15.5	47.5
1300		1170 Peak	17.2	47.0
1400		1000 Peak	17.0	46.5

Load Mismatch/Ruggedness

Frequency (MHz)	Signal Type	VSWR	P_{in} (W)	Test Voltage	Result
1400 (1)	Pulse (128 μ sec, 10% Duty Cycle)	> 20:1 at All Phase Angles	31.6 Peak (3 dB Overdrive)	52	No Device Degradation

1. Measured in 1400 MHz production test fixture.

Features

- Internally input and output matched for broadband operation and ease of use
- Device can be used in a single-ended, push-pull or quadrature configuration
- Qualified up to a maximum of 52 V_{DD} operation
- High ruggedness, handles > 20:1 VSWR
- Integrated ESD protection with greater negative gate-source voltage range for improved Class C operation and gate voltage pulsing
- Characterized with series equivalent large-signal impedance parameters

Typical Applications

- Military and commercial L-Band radar systems

MMRF1314H
MMRF1314HS
MMRF1314GS

1200–1400 MHz, 1000 W PEAK, 52 V
AIRFAST RF POWER LDMOS
TRANSISTORS

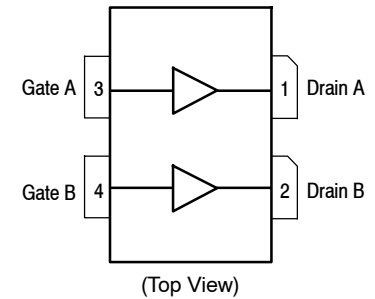
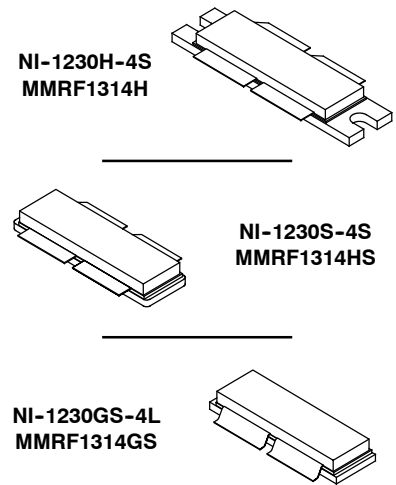

Note: The backside of the package is the source terminal for the transistor.

Figure 1. Pin Connections

Table 1. Maximum Ratings

Rating	Symbol	Value	Unit
Drain-Source Voltage	V_{DSS}	-0.5, +105	Vdc
Gate-Source Voltage	V_{GS}	-6.0, +10	Vdc
Storage Temperature Range	T_{stg}	-65 to +150	°C
Case Operating Temperature Range	T_C	-40 to +150	°C
Operating Junction Temperature Range (1)	T_J	-40 to +225	°C
Total Device Dissipation @ $T_C = 25^\circ\text{C}$ Derate above 25°C	P_D	909 4.55	W W/°C

Table 2. Thermal Characteristics

Characteristic	Symbol	Value (2,3)	Unit
Thermal Impedance, Junction to Case Case Temperature 60°C, 1000 W Peak, 128 μsec Pulse Width, 10% Duty Cycle, 50 Vdc, $I_{DQ(A+B)} = 100\text{ mA}$, 1400 MHz	$Z_{\theta JC}$	0.018	°C/W

Table 3. ESD Protection Characteristics

Test Methodology	Class
Human Body Model (per JESD22-A114)	2, passes 2500 V
Machine Model (per EIA/JESD22-A115)	B, passes 200 V
Charge Device Model (per JESD22-C101)	IV, passes 2000 V

Table 4. Electrical Characteristics ($T_A = 25^\circ\text{C}$ unless otherwise noted)

Characteristic	Symbol	Min	Typ	Max	Unit
----------------	--------	-----	-----	-----	------

Off Characteristics (4)

Gate-Source Leakage Current ($V_{GS} = 5\text{ Vdc}$, $V_{DS} = 0\text{ Vdc}$)	I_{GSS}	—	—	1	μAdc
Drain-Source Breakdown Voltage ($V_{GS} = 0\text{ Vdc}$, $I_D = 10\ \mu\text{Adc}$)	$V_{(BR)DSS}$	105	—	—	Vdc
Zero Gate Voltage Drain Leakage Current ($V_{DS} = 50\text{ Vdc}$, $V_{GS} = 0\text{ Vdc}$)	I_{DSS}	—	—	1	μAdc
Zero Gate Voltage Drain Leakage Current ($V_{DS} = 105\text{ Vdc}$, $V_{GS} = 0\text{ Vdc}$)	I_{DSS}	—	—	10	μAdc

On Characteristics

Gate Threshold Voltage (4) ($V_{DS} = 10\text{ Vdc}$, $I_D = 520\ \mu\text{Adc}$)	$V_{GS(th)}$	1.3	1.8	2.3	Vdc
Gate Quiescent Voltage (5) ($V_{DD} = 50\text{ Vdc}$, $I_{DQ(A+B)} = 100\text{ mAdc}$, Measured in Functional Test)	$V_{GS(Q)}$	1.6	2.1	2.6	Vdc
Drain-Source On-Voltage (4) ($V_{GS} = 10\text{ Vdc}$, $I_D = 2.6\text{ Adc}$)	$V_{DS(on)}$	0.05	0.16	0.35	Vdc

Dynamic Characteristics (4)

Reverse Transfer Capacitance ($V_{DS} = 50\text{ Vdc} \pm 30\text{ mV(rms)ac}$ @ 1 MHz, $V_{GS} = 0\text{ Vdc}$)	C_{rss}	—	2.98	—	pF
---	-----------	---	------	---	----

1. Continuous use at maximum temperature will affect MTTF.
2. MTTF calculator available at <http://www.nxp.com/RF/calculators>.
3. Refer to AN1955, *Thermal Measurement Methodology of RF Power Amplifiers*. Go to <http://www.nxp.com/RF> and search for AN1955.
4. Each side of device measured separately.
5. Measurement made with device in push-pull configuration.

(continued)

Table 4. Electrical Characteristics ($T_A = 25^\circ\text{C}$ unless otherwise noted) (continued)

Characteristic	Symbol	Min	Typ	Max	Unit
Functional Tests ^(1,2) (In NXP Narrowband Production Test Fixture, 50 ohm system) $V_{DD} = 50\text{ Vdc}$, $I_{DQ(A+B)} = 100\text{ mA}$, $P_{out} = 1000\text{ W Peak}$ (100 W Avg.), $f = 1400\text{ MHz}$, 128 μsec Pulse Width, 10% Duty Cycle					
Power Gain	G_{ps}	16.0	17.7	19.5	dB
Drain Efficiency	η_D	46.0	52.1	—	%
Input Return Loss	IRL	—	-18	-9	dB

Load Mismatch/Ruggedness (In NXP Narrowband Test Fixture, 50 ohm system) $I_{DQ(A+B)} = 100\text{ mA}$

Frequency (MHz)	Signal Type	VSWR	P_{in} (W)	Test Voltage, V_{DD}	Result
1400	Pulse (128 μsec , 10% Duty Cycle)	> 20:1 at all Phase Angles	31.6 Peak (3 dB Overdrive)	52	No Device Degradation

Table 5. Ordering Information

Device	Tape and Reel Information	Package
MMRF1314HR5	R5 Suffix = 50 Units, 56 mm Tape Width, 13-inch Reel	NI-1230H-4S, Eared
MMRF1314HSR5		NI-1230S-4S, Earless
MMRF1314GSR5		NI-1230GS-4L, Gull Wing

1. Measurement made with device in push-pull configuration.
2. Measurements made with device in straight lead configuration before any lead forming operation is applied. Lead forming is used for gull wing (GS) parts.

TYPICAL CHARACTERISTICS



Note: Each side of device measured separately.

Figure 2. Capacitance versus Drain-Source Voltage

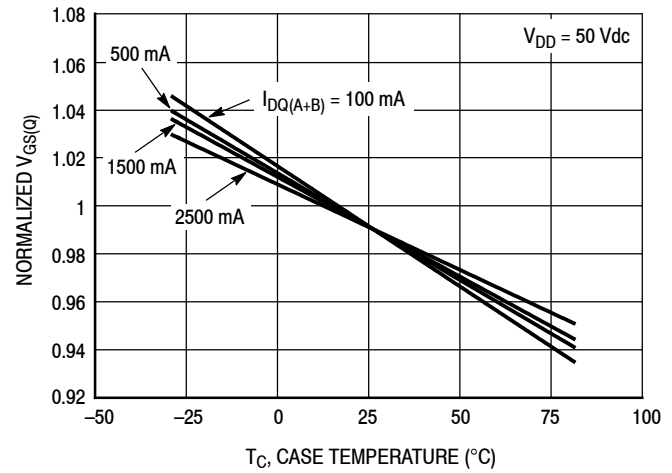

I_{DQ} (mA)	Slope (mV/°C)
100	-2.06
500	-1.96
1500	-1.94
2500	-1.72

Figure 3. Normalized V_{GS} versus Quiescent Current and Case Temperature

1200–1400 MHz REFERENCE CIRCUIT — 3.0" × 4.0" (7.6 cm × 10.2 cm)

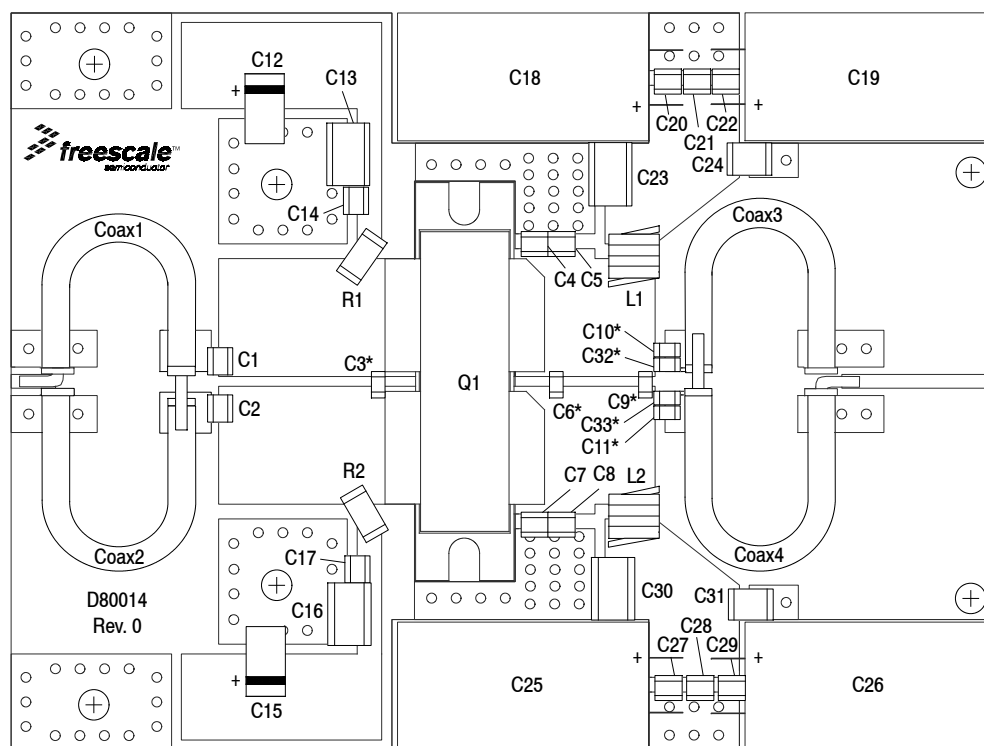

* C3, C6, C9, C10, C11, C32 and C33 are mounted vertically.

Figure 4. MMRF1314H(HS) Reference Circuit Component Layout — 1200–1400 MHz

Table 6. MMRF1314H(HS) 1200–1400 MHz Reference Circuit Component Designations and Values

Part	Description	Part Number	Manufacturer
C1, C2	13 pF Chip Capacitors	ATC800B130JT500XT	ATC
C3, C6	3.9 pF Chip Capacitors	ATC800B3R9CT500XT	ATC
C4, C7	6.2 pF Chip Capacitors	ATC800B6R2BT500XT	ATC
C5, C8	2.0 pF Chip Capacitors	ATC800B2R0BT500XT	ATC
C9	2.7 pF Chip Capacitor	ATC800B2R7BT500XT	ATC
C10, C11, C32, C33	7.5 pF Chip Capacitors	ATC800B7R5JT500XT	ATC
C12, C15	22 μ F, 25 V Tantalum Capacitors	TPSD226M025R0200	AVX
C13, C16	2.2 μ F Chip Capacitors	C1825C225J5RACTU	Kemet
C14, C17, C20, C27	24 pF Chip Capacitors	ATC100B240CT500XT	ATC
C18, C19, C25, C26	470 μ F, 63 V Electrolytic Capacitors	MCGPR63V477M13X26-RH	Multicomp
C21, C28	2.2 μ F Chip Capacitors	C3225X7R2A225KT	TDK
C22, C29	1000 pF Chip Capacitors	ATC100B102JT50XT	ATC
C23, C30	0.022 μ F Chip Capacitors	C1825C223K1GACTU	Kemet
C24, C31	0.10 μ F Chip Capacitors	C1812F104K1RACTU	Kemet
Coax1, 2, 3, 4	35 Ω Semi-flexible Coax Cable, 1.5" Shield Length	HSF-141C-35	Hongsen Cable
L1, L2	3.7 nH Inductors, 1 Turn	GA3092-ALC	Coilcraft
Q1	RF Power LDMOS Transistor	MMRF1314H	NXP
R1, R2	1000 Ω , 1/2 W Chip Resistors	CRCW20101K00FKEF	Vishay
PCB	Arlon 450 0.030", $\epsilon_r = 4.5$	D80014	MTL

TYPICAL CHARACTERISTICS — 1200–1400 MHz REFERENCE CIRCUIT

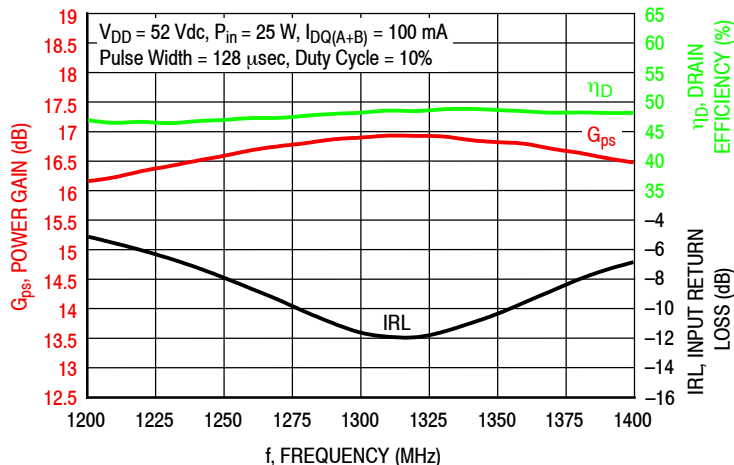

Figure 5. Power Gain, Drain Efficiency and IRL versus Frequency at a Constant Input Power

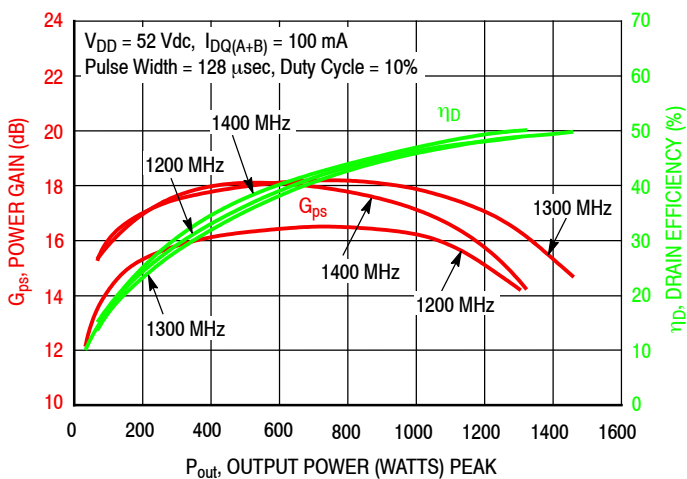

Figure 6. Power Gain and Drain Efficiency versus Output Power

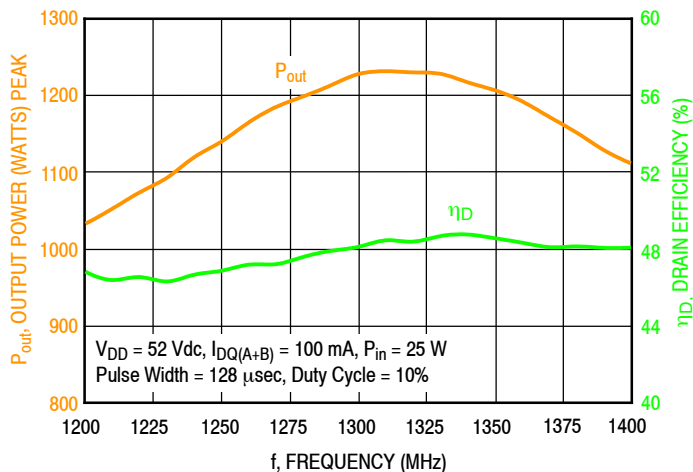
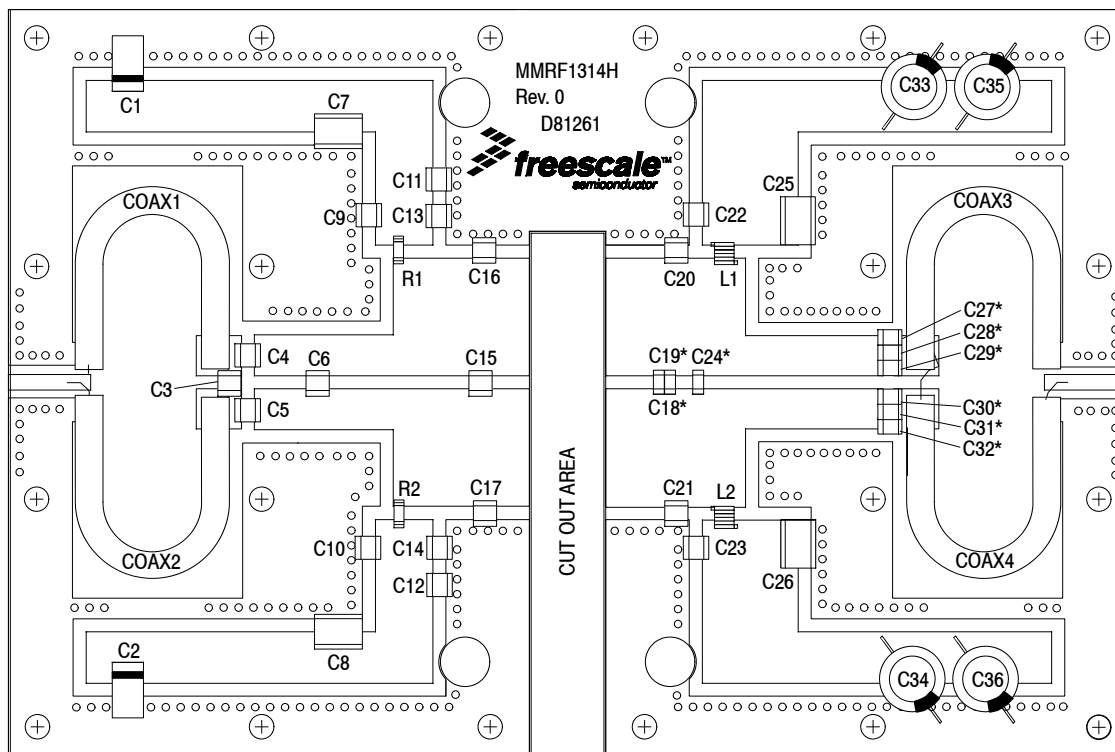

Figure 7. Output Power and Drain Efficiency versus Frequency at a Constant Input Power

1400 MHz NARROWBAND PRODUCTION TEST FIXTURE — 4.0" x 6.0" (10.2 cm x 15.2 cm)



* C18, C19, C24, C27, C28, C29, C30, C31 and C32 are mounted vertically.

Figure 8. MMRF1314H(HS) Narrowband Test Circuit Component Layout — 1400 MHz

Table 7. MMRF1314H(HS) 1400 MHz Narrowband Circuit Component Designations and Values

Part	Description	Part Number	Manufacturer
C1, C2	22 μ F, 35 V Tantalum Capacitors	T491X226K035AT	Kemet
C3	2.7 pF Chip Capacitor	ATC100B2R7BT500XT	ATC
C4, C5, C9, C10, C13, C14, C22, C23	27 pF Chip Capacitors	ATC100B270JT500XT	ATC
C6	1.5 pF Chip Capacitor	ATC100B1R5BT500XT	ATC
C7, C8	2.2 μ F Chip Capacitors	C1825C225J5RACTU	Kemet
C11, C12	0.1 μ F Chip Capacitors	CDR33BX104AKY9S	AVX
C15	2.2 pF Chip Capacitor	ATC100B2R2BT500XT	ATC
C16, C17	0.7 pF Chip Capacitors	ATC100B0R7BT500XT	ATC
C18	1.5 pF Chip Capacitor	ATC100B1R5BT500XT	ATC
C19	1.2 pF Chip Capacitor	ATC100B1R2BT500XT	ATC
C20, C21	2.2 pF Chip Capacitors	ATC100B2R2BT500XT	ATC
C24	1.5 pF Chip Capacitor	ATC100B1R5BT500XT	ATC
C25, C26	0.01 μ F Chip Capacitors	C1825C103K1GACTU	Kemet
C27, C28, C29, C30, C31, C32	27 pF Chip Capacitors	ATC100B270JT500XT	ATC
C33, C34, C35, C36	470 μ F, 63 V Electrolytic Capacitors	MCGPR63V477M13X26-RH	Multicomp
Coax1, 2, 3, 4	35 Ω Semi-flexible Coax Cable, 1.454" Shield Length	HSF-141C-35	Hongsen Cable
L1, L2	17.5 nH Inductors, 4 Turn	GA3095-ALC	Coilcraft
R1, R2	100 Ω , 1 W Chip Resistors	CRCW2512100RFKEG	Vishay
PCB	Arlon AD255A, 0.03", $\epsilon_r = 2.55$	D81261	MTL

TYPICAL CHARACTERISTICS — 1400 MHz PRODUCTION TEST FIXTURE

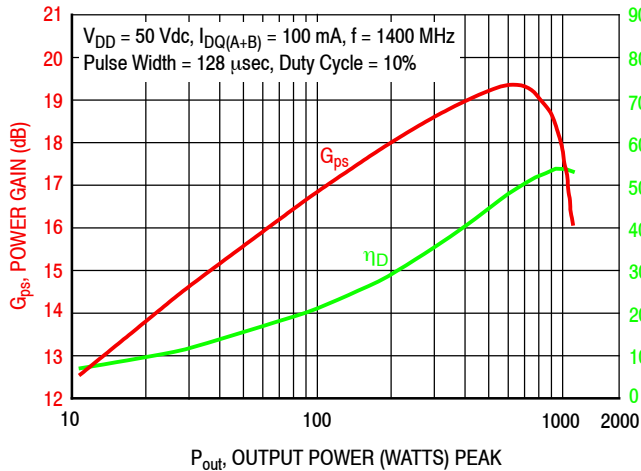
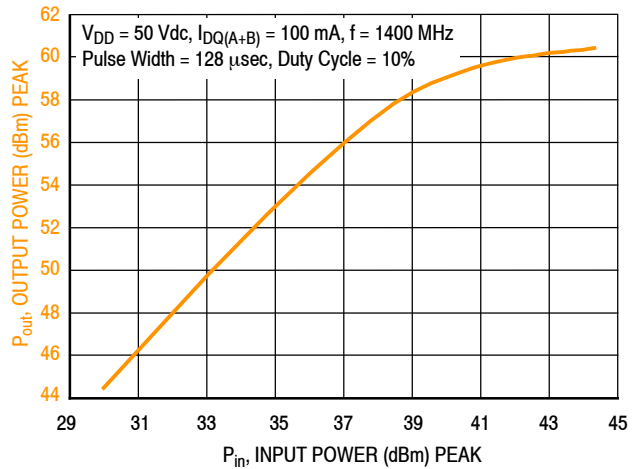

Figure 9. Power Gain and Drain Efficiency versus Output Power



f (MHz)	P1dB (W)	P3dB (W)
1400	948	1079

Figure 10. Output Power versus Input Power

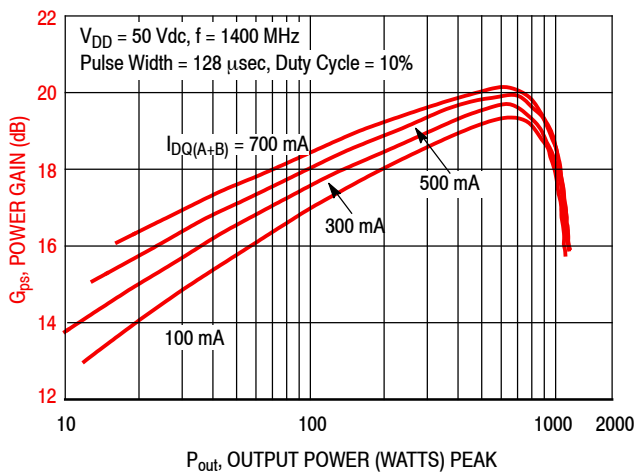

Figure 11. Power Gain versus Output Power

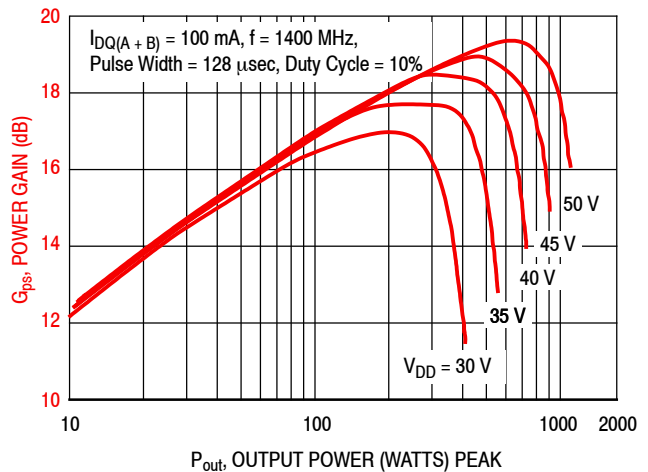

Figure 12. Power Gain versus Output Power

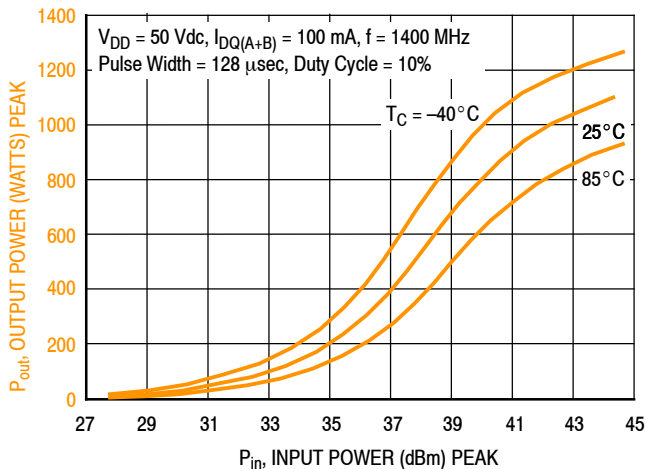

Figure 13. Output Power versus Input Power

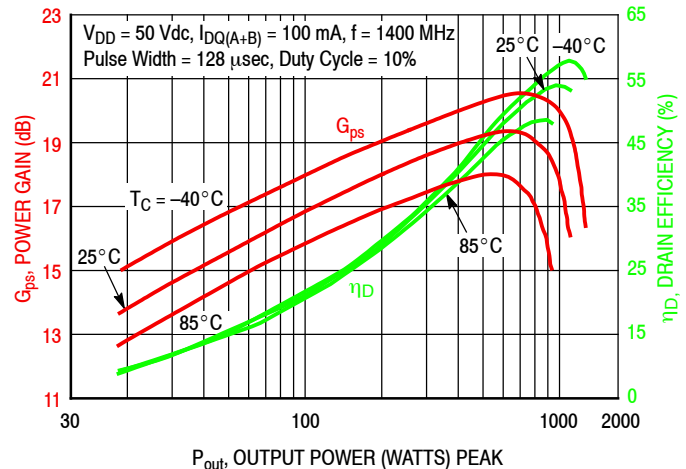

Figure 14. Power Gain and Drain Efficiency versus Output Power

1400 MHz NARROWBAND PRODUCTION TEST FIXTURE

f MHz	Z_{source} Ω	Z_{load} Ω
1400	$7.35 - j4.62$	$1.3 - j.072$

Z_{source} = Test circuit impedance as measured from gate to gate, balanced configuration.

Z_{load} = Test circuit impedance as measured from drain to drain, balanced configuration.

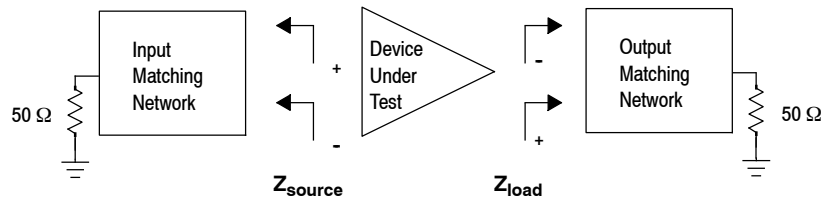
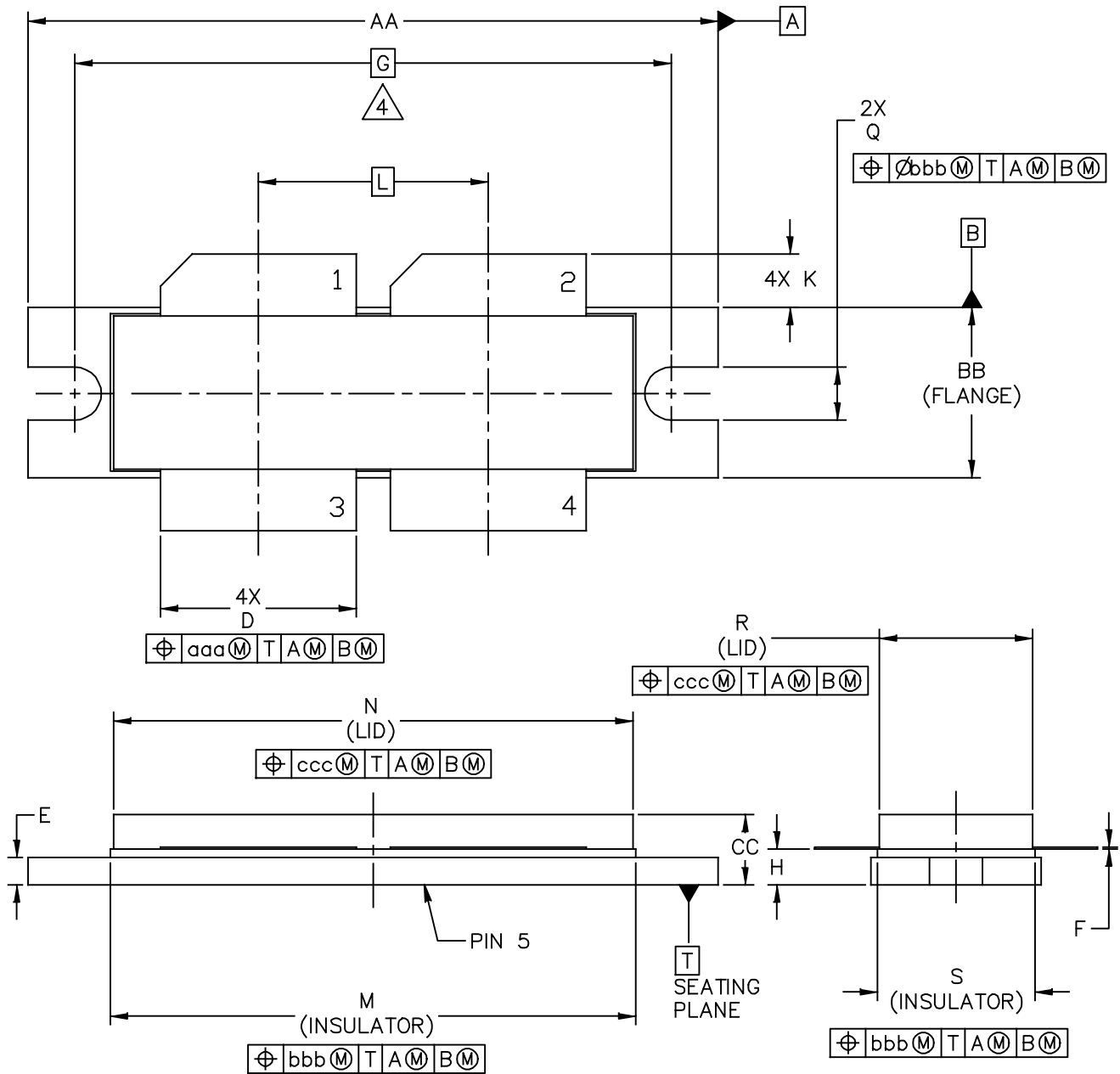

Figure 15. Narrowband Series Equivalent Source and Load Impedance — 1400 MHz

PACKAGE DIMENSIONS



© NXP SEMICONDUCTORS N.V. ALL RIGHTS RESERVED	MECHANICAL OUTLINE	PRINT VERSION NOT TO SCALE
TITLE: NI-1230-4H	DOCUMENT NO: 98ASB16977C STANDARD: NON-JEDEC SOT1787-1	REV: G 03 MAR 2016

NOTES:

1. INTERPRET DIMENSIONS AND TOLERANCES PER ASME Y14.5M-1994.
2. CONTROLLING DIMENSION: INCH
3. DIMENSION H IS MEASURED .030 INCH (0.762 MM) AWAY FROM PACKAGE BODY.
4. RECOMMENDED BOLT CENTER DIMENSION OF 1.52 INCH (38.61 MM) BASED ON M3 SCREW.

DIM	INCH		MILLIMETER		DIM	INCH		MILLIMETER	
	MIN	MAX	MIN	MAX		MIN	MAX	MIN	MAX
AA	1.615	1.625	41.02	41.28	N	1.218	1.242	30.94	31.55
BB	.395	.405	10.03	10.29	Q	.120	.130	3.05	3.30
CC	.170	.190	4.32	4.83	R	.355	.365	9.02	9.27
D	.455	.465	11.56	11.81	S	.365	.375	9.27	9.53
E	.062	.066	1.57	1.68					
F	.004	.007	0.10	0.18					
G	1.400 BSC		35.56 BSC		aaa	.013		0.33	
H	.082	.090	2.08	2.29	bbb	.010		0.25	
K	.117	.137	2.97	3.48	ccc	.020		0.51	
L	.540 BSC		13.72 BSC						
M	1.219	1.241	30.96	31.52					
© NXP SEMICONDUCTORS N.V. ALL RIGHTS RESERVED			MECHANICAL OUTLINE			PRINT VERSION NOT TO SCALE			
TITLE:					DOCUMENT NO: 98ASB16977C		REV: G		
NI-1230-4H					STANDARD: NON-JEDEC				
					SOT1787-1		03 MAR 2016		

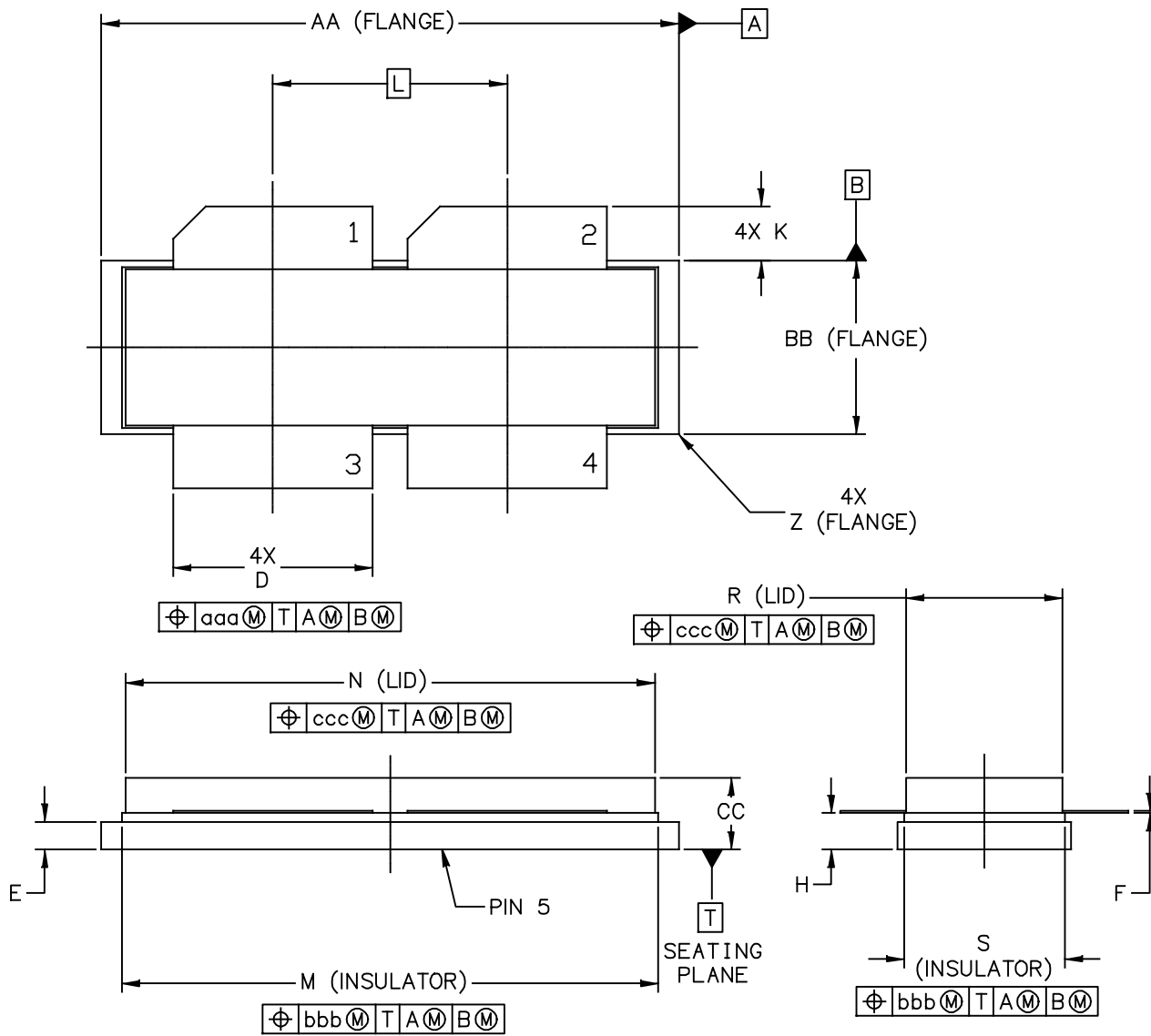

© NXP SEMICONDUCTORS N. V. ALL RIGHTS RESERVED	MECHANICAL OUTLINE	PRINT VERSION NOT TO SCALE
TITLE: NI-1230-4S	DOCUMENT NO: 98ARB18247C	REV: H
	STANDARD: NON-JEDEC	
	SOT1829-1	19 FEB 2016

NOTES:

1. INTERPRET DIMENSIONS AND TOLERANCES PER ASME Y14.5M-1994.
2. CONTROLLING DIMENSION: INCH
3. DIMENSION H IS MEASURED .030 INCH (0.762 MM) AWAY FROM PACKAGE BODY

DIM	INCHES		MILLIMETERS		DIM	INCHES		MILLIMETERS	
	MIN	MAX	MIN	MAX		MIN	MAX	MIN	MAX
AA	1.265	1.275	32.13	32.39	R	.355	.365	9.02	9.27
BB	.395	.405	10.03	10.29	S	.365	.375	9.27	9.53
CC	.170	.190	4.32	4.83	Z	R.000	R.040	R0.00	R1.02
D	.455	.465	11.56	11.81					
E	.062	.066	1.57	1.68	aaa	.013		0.33	
F	.004	.007	0.10	0.18	bbb	.010		0.25	
H	.082	.090	2.08	2.29	ccc	.020		0.51	
K	.117	.137	2.97	3.48					
L	.540 BSC		13.72 BSC						
M	1.219	1.241	30.96	31.52					
N	1.218	1.242	30.94	31.55					
© NXP SEMICONDUCTORS N.V. ALL RIGHTS RESERVED			MECHANICAL OUTLINE			PRINT VERSION NOT TO SCALE			
TITLE: NI-1230-4S					DOCUMENT NO: 98ARB18247C REV: H				
					STANDARD: NON-JEDEC				
					SOT1829-1			19 FEB 2016	

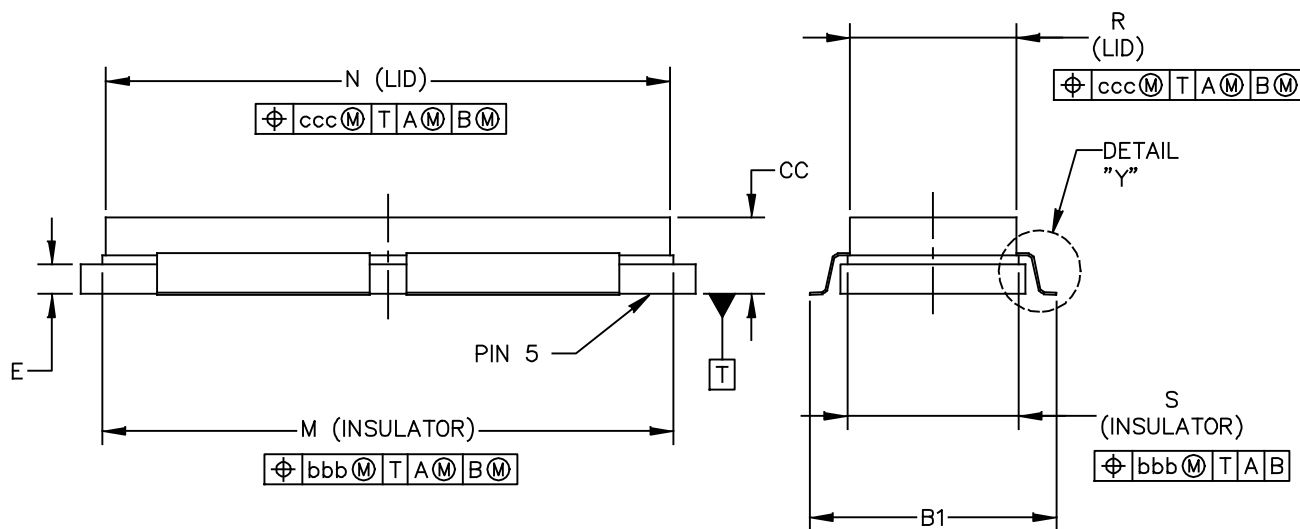
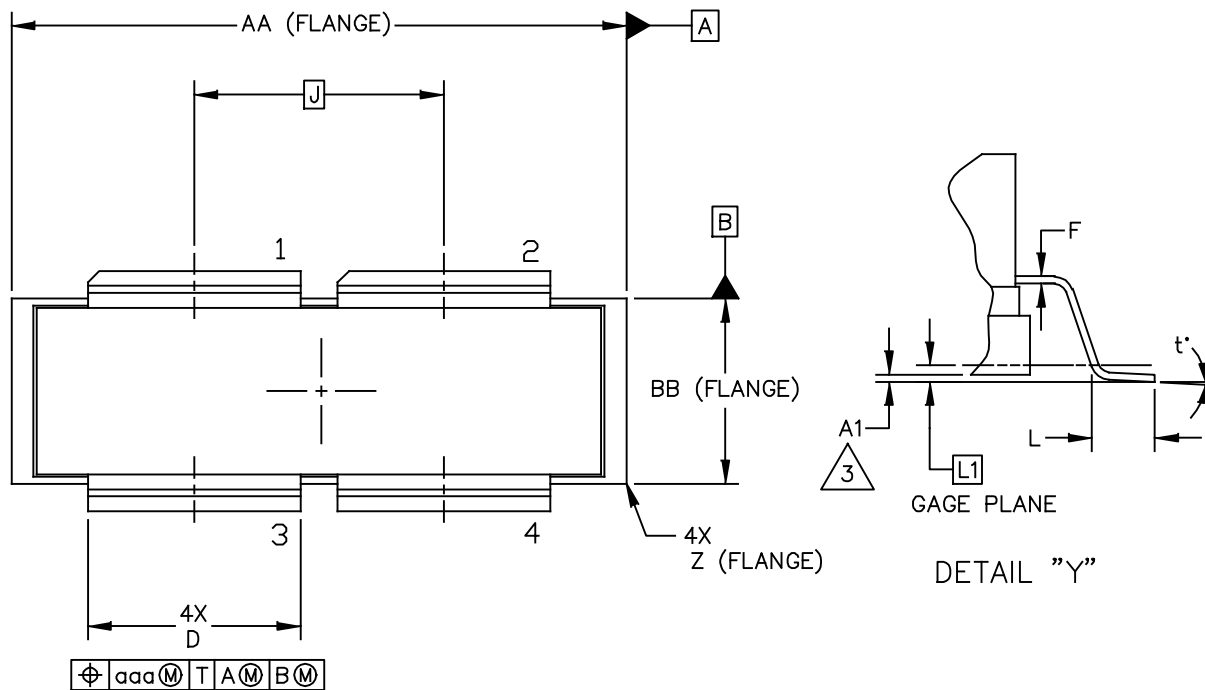

© NXP SEMICONDUCTORS N. V. ALL RIGHTS RESERVED	MECHANICAL OUTLINE	PRINT VERSION NOT TO SCALE
TITLE: NI-1230-4S GULL	DOCUMENT NO: 98ASA00459D	REV: B
	STANDARD: NON-JEDEC	
	SOT1806-2	23 FEB 2016

NOTES:

1. INTERPRET DIMENSIONS AND TOLERANCES PER ASME Y14.5M-1994.
2. CONTROLLING DIMENSION: INCH

3. DIMENSION A1 IS MEASURED WITH REFERENCE TO DATUM T. THE POSITIVE VALUE IMPLIES THAT THE PACKAGE BOTTOM IS HIGHER THAN THE LEAD BOTTOM.

DIM	INCHES		MILLIMETERS		DIM	INCHES		MILLIMETERS	
	MIN	MAX	MIN	MAX		MIN	MAX	MIN	MAX
AA	1.265	1.275	32.13	32.39	R	.355	.365	9.02	9.27
A1	-.001	.011	-0.03	0.28	S	.365	.375	9.27	9.53
BB	.395	.405	10.03	10.29	Z	R.000	R.040	R0.00	R1.02
B1	.564	.574	14.32	14.58	t*	0*	8*	0*	8*
CC	.170	.190	4.32	4.83					
D	.455	.465	11.56	11.81	aaa	.013		0.33	
E	.062	.066	1.57	1.68	bbb	.010		0.25	
F	.004	.007	0.10	0.18	ccc	.020		0.51	
J	.540 BSC		13.72 BSC						
L	.038	.046	0.97	1.17					
L1	.01 BSC		0.25 BSC						
M	1.219	1.241	30.96	31.52					
N	1.218	1.242	30.94	31.55					
© NXP SEMICONDUCTORS N.V. ALL RIGHTS RESERVED			MECHANICAL OUTLINE			PRINT VERSION NOT TO SCALE			
TITLE: NI-1230-4S GULL					DOCUMENT NO: 98ASA00459D REV: B				
					STANDARD: NON-JEDEC				
					SOT1806-2			23 FEB 2016	

PRODUCT DOCUMENTATION AND SOFTWARE

Refer to the following resources to aid your design process.

Application Notes

- AN1908: Solder Reflow Attach Method for High Power RF Devices in Air Cavity Packages
- AN1955: Thermal Measurement Methodology of RF Power Amplifiers

Engineering Bulletins

- EB212: Using Data Sheet Impedances for RF LDMOS Devices

Software

- Electromigration MTTF Calculator

To Download Resources Specific to a Given Part Number:

1. Go to <http://www.nxp.com/RF>
2. Search by part number
3. Click part number link
4. Choose the desired resource from the drop down menu

REVISION HISTORY

The following table summarizes revisions to this document.

Revision	Date	Description
0	Mar. 2016	<ul style="list-style-type: none">• Initial Release of Data Sheet
1	Jan. 2017	<ul style="list-style-type: none">• 1200–1400 MHz reference circuit: added performance data and graphs, reference circuit component layout and component designations, pp. 5–6

How to Reach Us:

Home Page:
nxp.com

Web Support:
nxp.com/support

Information in this document is provided solely to enable system and software implementers to use NXP products. There are no express or implied copyright licenses granted hereunder to design or fabricate any integrated circuits based on the information in this document. NXP reserves the right to make changes without further notice to any products herein.

NXP makes no warranty, representation, or guarantee regarding the suitability of its products for any particular purpose, nor does NXP assume any liability arising out of the application or use of any product or circuit, and specifically disclaims any and all liability, including without limitation consequential or incidental damages. "Typical" parameters that may be provided in NXP data sheets and/or specifications can and do vary in different applications, and actual performance may vary over time. All operating parameters, including "typicals," must be validated for each customer application by customer's technical experts. NXP does not convey any license under its patent rights nor the rights of others. NXP sells products pursuant to standard terms and conditions of sale, which can be found at the following address: nxp.com/SalesTermsandConditions.

NXP, the NXP logo, Freescale, and the Freescale logo are trademarks of NXP B.V. All other product or service names are the property of their respective owners.
© 2017 NXP B.V.



Mouser Electronics

Authorized Distributor

Click to View Pricing, Inventory, Delivery & Lifecycle Information:

[NXP:](#)

[MMRF1314HR5](#) [MMRF1314GSR5](#) [MMRF1314HSR5](#)