

mikroProg™ for Tiva™

mikroProg™ is a fast USB programmer with hardware Debugger support. Smart engineering allows mikroProg™ to support all Tiva™ and Stellaris® ARM® Cortex™-M3 and Cortex™-M4 microcontrollers in a single programmer.



TO OUR VALUED CUSTOMERS

I want to express my thanks to you for being interested in our products and for having confidence in MikroElektronika.

The primary aim of our company is to design and produce high quality electronic products and to constantly improve the performance thereof in order to better suit your needs.

A handwritten signature in white ink, appearing to read 'N. Matic', is positioned on the right side of the page. The signature is fluid and cursive, with a large initial 'N' and 'M'.

Nebojsa Matic
General Manager

Table of Contents

Introduction to mikroProg™	4	6. Connection schematic examples	14
Key features	5	Connecting with LM3SX00 series	15
1. Driver installation	6	Connecting with LM3S1000 series	16
step 1 - Start installation	7	Connecting with LM3S2000 series	17
step 2 - Accept EULA	7	Connecting with LM3S3000 series	18
step 3 - Installing the drivers	8	Connecting with LM3S5000 series	19
step 4 - Finish installation	8	Connecting with LM3S6000 series	20
2. Connecting to a PC	9	Connecting with LM3S8000 series	21
3. mikroProg Suite™ for ARM® software	10	Connecting with LM3S9000 series	22
4. Connecting with a target device	12	Connecting with TM4C123 series	23
5. Connector Pinout	13	Connecting with TM4C129 series	24

Introduction to mikroProg™



mikroProg™ for Tiva™ is a fast programmer and hardware debugger. Smart engineering allows mikroProg™ to support all Tiva™ and Stellaris® ARM® Cortex™-M3 and Cortex™-M4 devices in a single programmer! Outstanding performance, easy operation, elegant design and low price are it's top features. It is supported in MikroElektronika ARM® compilers, as well as in other ARM® compilers.

Key features

- **Hardware Debugging**
- No need for firmware update
- New microcontrollers supported via latest version of **mikroProg Suite™** for **ARM®** software

What you see

- 01 Flat cable
- 02 USB MINIB connector
- 03 DATA transfer indication LED
- 04 ACTIVE indication LED
- 05 LINK indication LED
- 06 POWER indication LED



1. Driver installation

On-board mikroProg™ requires drivers in order to work. Drivers can be found on the link below:



http://www.mikroe.com/downloads/get/1810/mikroprog_tiva_drivers_v100.zip

When you download the drivers, please extract files from the ZIP archive. Folder with extracted files contains folders with drivers for different operating systems. Depending on which operating system you use, choose adequate folder and open it.



In the opened folder you should be able to locate the driver setup file. Double click the setup file to begin installation of the programmer drivers.

NOTE: Make sure to disconnect mikroProg™ before installing drivers.

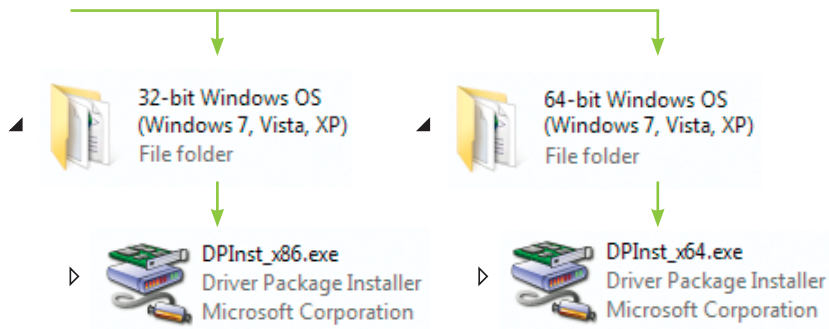

step 1 - Start installation



- 01 In welcome screen click the **Next >** button

step 2 - Accept EULA

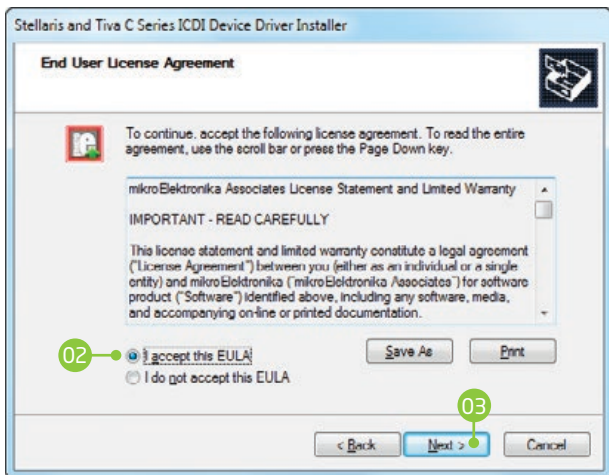

- 02 In order to proceed select **I accept the this EULA** (End User License Agreement)
- 03 Click the **Next >** button

step 3 - Installing the drivers

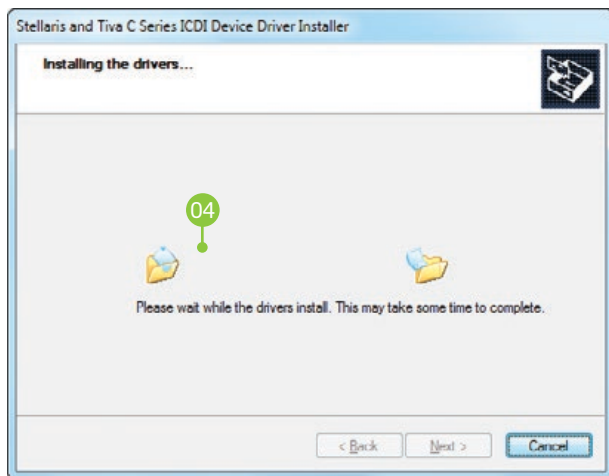

04 Drivers are installed automatically

step 4 - Finish installation

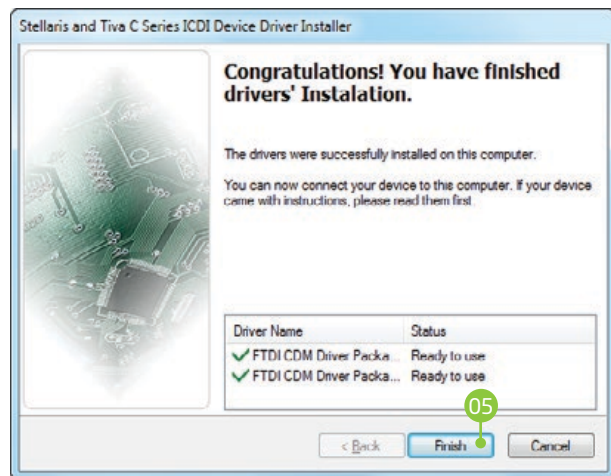

05 Click the **Finish** button to end installation process

2. Connecting to a PC

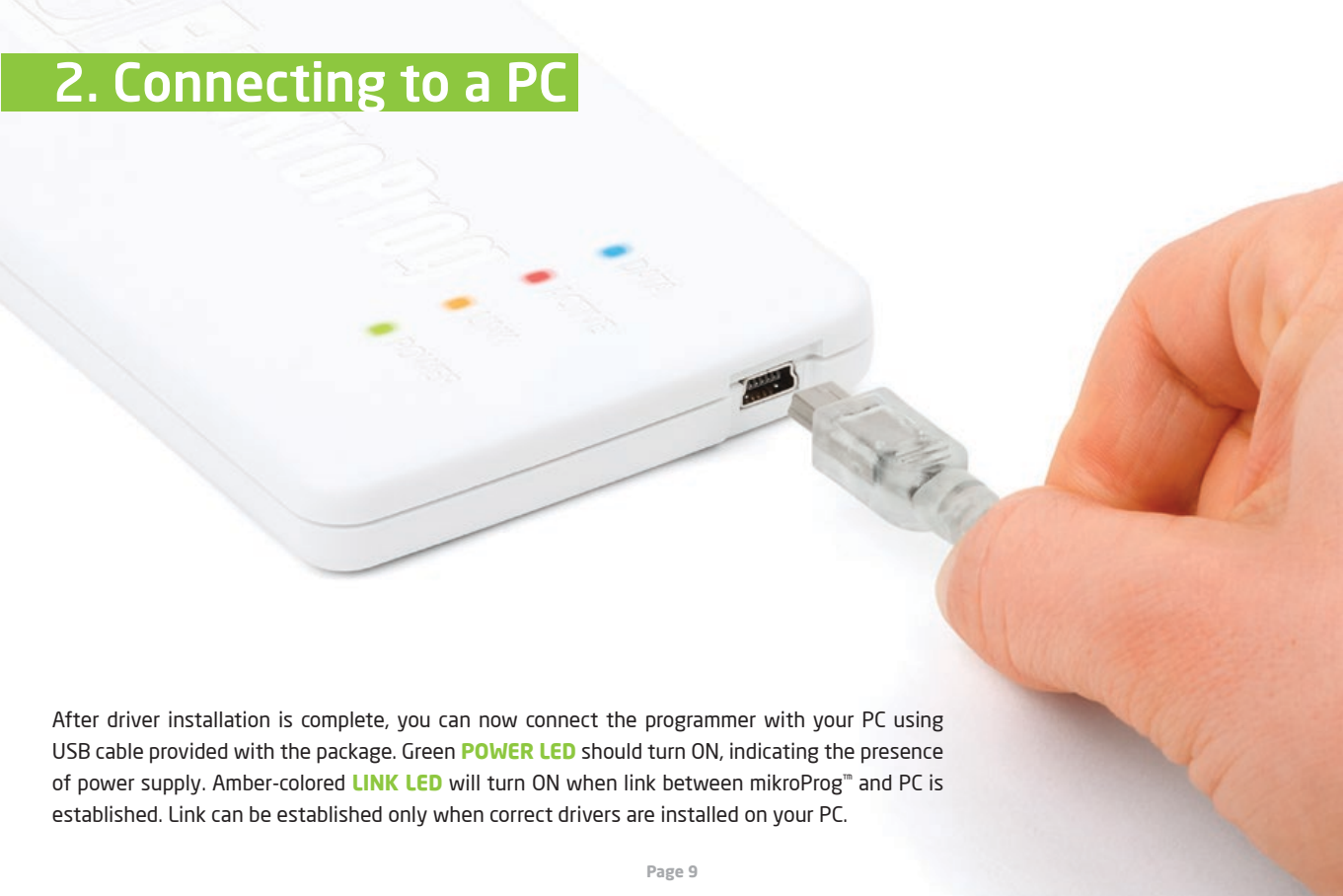

After driver installation is complete, you can now connect the programmer with your PC using USB cable provided with the package. Green **POWER LED** should turn ON, indicating the presence of power supply. Amber-colored **LINK LED** will turn ON when link between mikroProg™ and PC is established. Link can be established only when correct drivers are installed on your PC.

3. mikroProg Suite™ for ARM® software

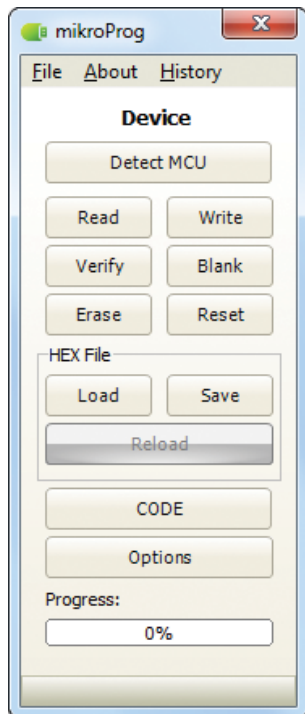

mikroProg™ for Tiva™ programmer requires **special programming software** called mikroProg Suite™ for ARM®. This software is used for programming all Tiva™ and Stellaris® ARM® Cortex-M3™ and Cortex-M4™ microcontroller families. It features intuitive interface and SingleClick™ programming technology. Software installation is available on following link:



http://www.mikroe.com/downloads/get/1809/mikroprog_suite_for_arm.zip

After downloading, extract the package and double click the executable setup file to start installation.

Quick Guide

- 01 Click the **Detect MCU** button in order to recognize the device ID.
- 02 Click the **Read** button to read the entire microcontroller memory. You can click the **Save** button to save it to the target HEX file.
- 03 If you want to write the HEX file into the microcontroller, first make sure to load the target HEX file using the **Load** button. Then click the **Write** button to begin programming.
- 04 Click the **Erase** button to clear the microcontroller memory.

Software installation wizard



01 Start Installation

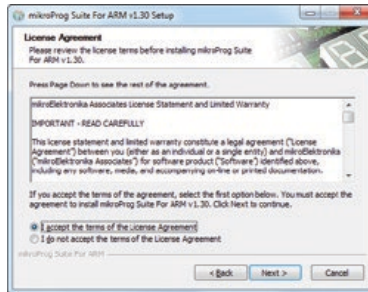

02 Accept EULA and continue

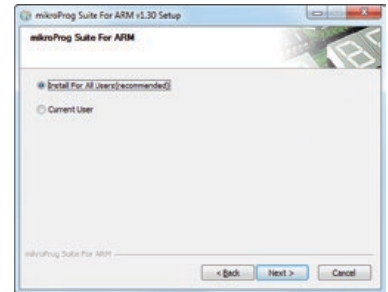

03 Install for all users

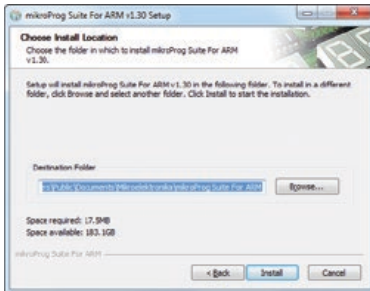

04 Choose destination folder

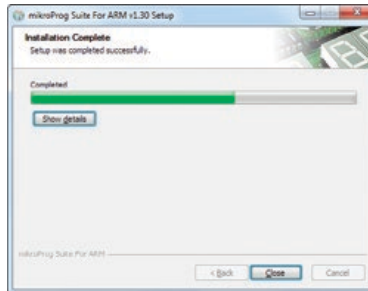

05 Installation in progress



06 Finish installation

4. Connecting with a target device

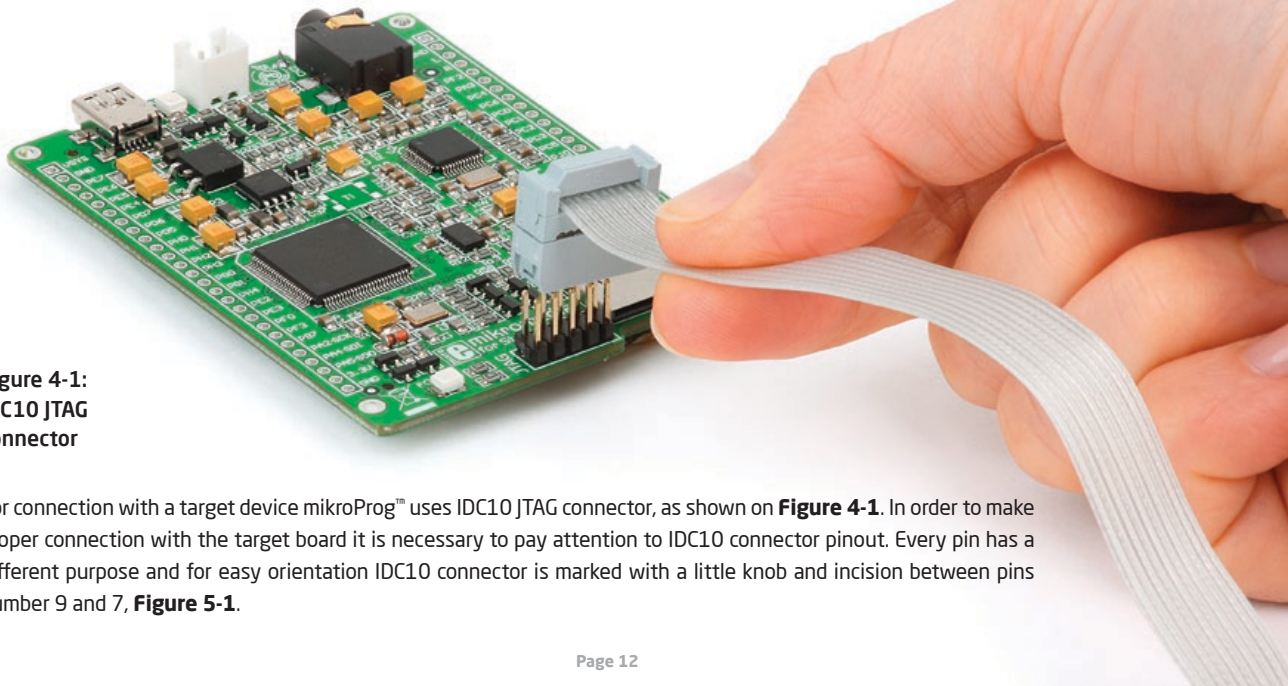

Figure 4-1:
IDC10 JTAG
connector

For connection with a target device mikroProg™ uses IDC10 JTAG connector, as shown on **Figure 4-1**. In order to make proper connection with the target board it is necessary to pay attention to IDC10 connector pinout. Every pin has a different purpose and for easy orientation IDC10 connector is marked with a little knob and incision between pins number 9 and 7, **Figure 5-1**.

5. Connector Pinout

01 **VCC-3.3V** - MCU power supply

03 **GND** - Ground

05 **GND** - Ground

07 **N/C** - Not Connected

09 **GND** - Ground

02 **TMS** - Mode Select

04 **TCK** - Clock

06 **TDO** - Data output

08 **TDI** - Data input

10 **SRSTn** - System Reset

JTAG programming/
debugging lines

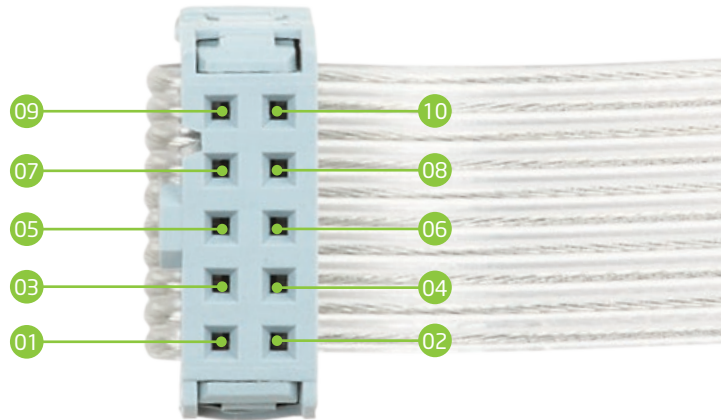
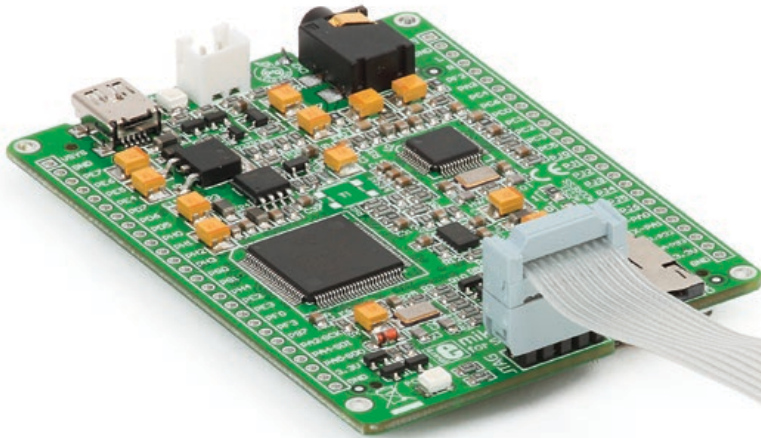

Figure 5-1: Female connector pinout

6. Connection schematic examples



Following examples demonstrate connections with some of the most popular supported microcontrollers. Each one is carefully selected as a representative of the entire family. All MCUs use TMS, TCK, TDO, TDI and SRSTn lines for programming. These lines are located on same microcontroller pins within a family.

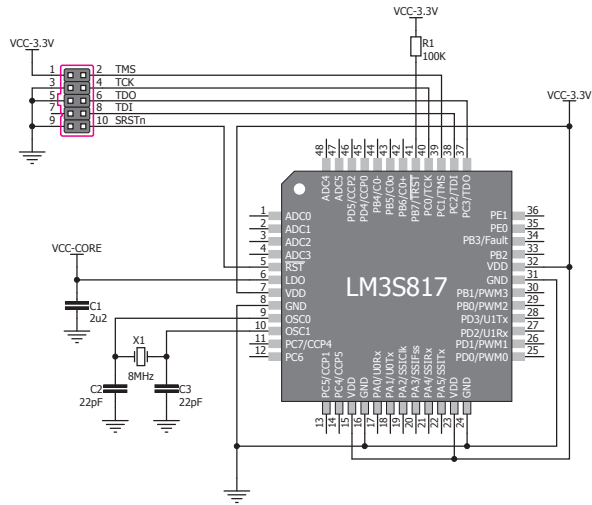

Figure 6-1: Connection schematics for 48-pin LM3S817 MCU via 2x5 male header

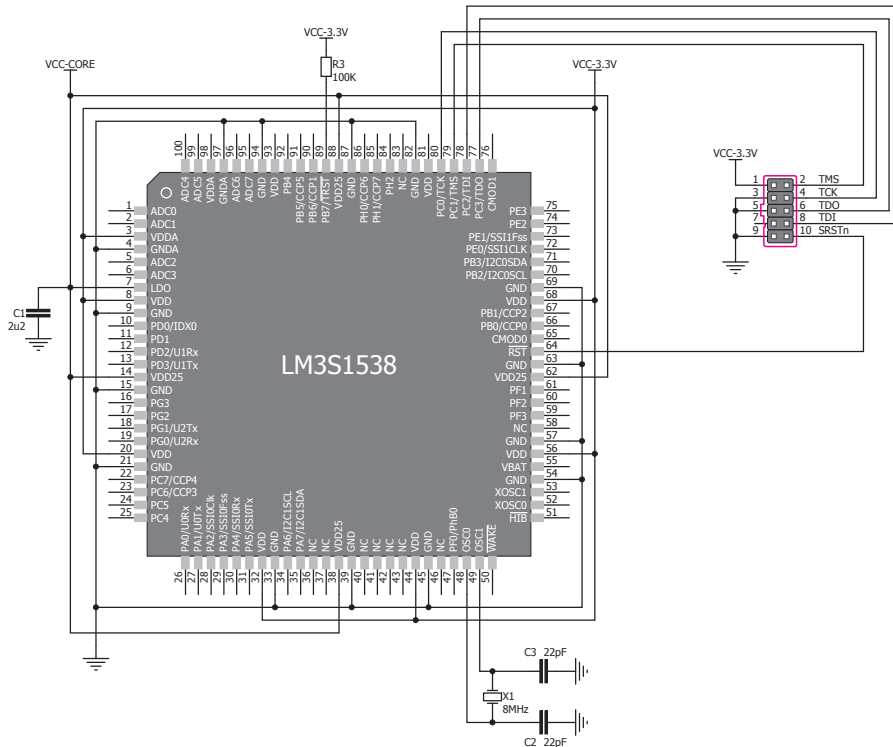

Figure 6-2: Connection schematic for 100-pin LM3S1538 MCU via 2x5 male header

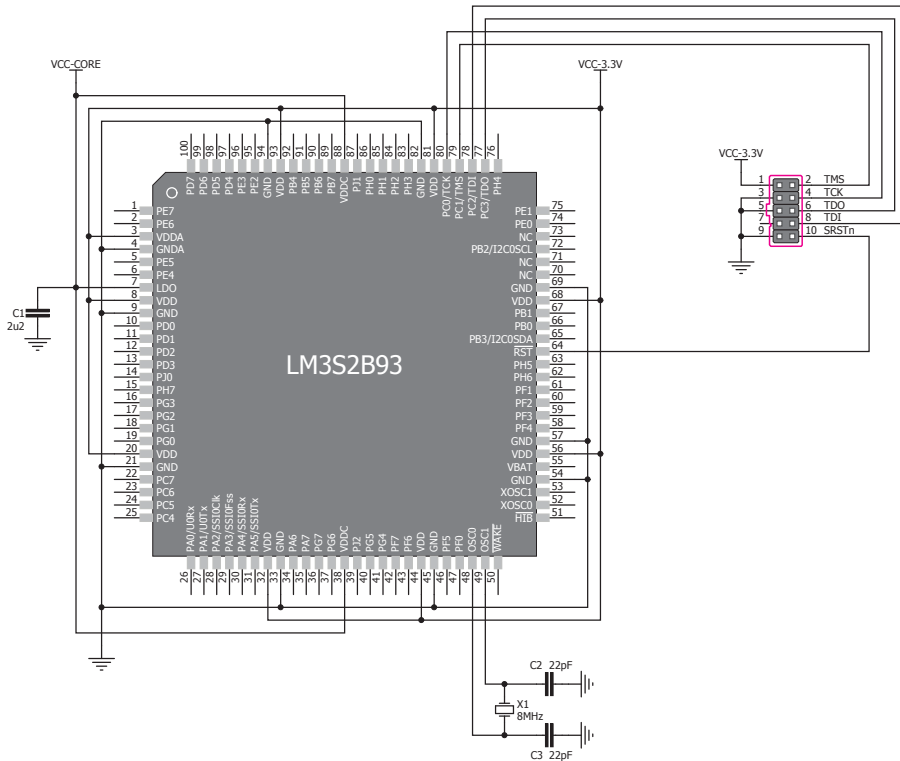

Figure 6-3: Connection schematic for 100-pin LM3S2B93 MCU via 2x5 male header

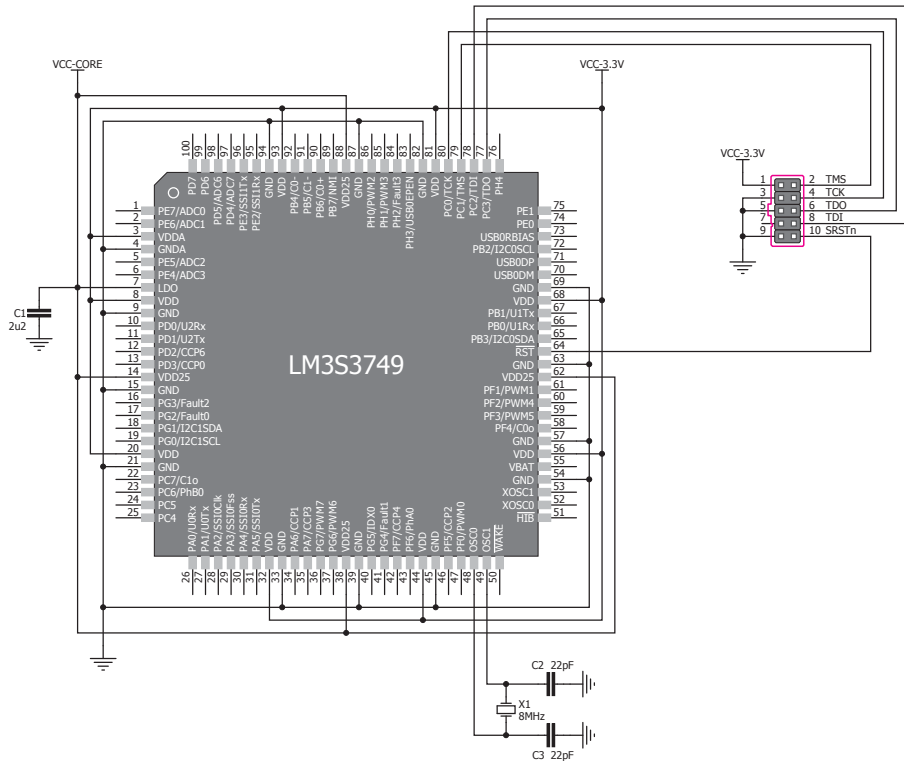

Figure 6-4: Connection schematic for 100-pin LM3S3749 MCU via 2x5 male header

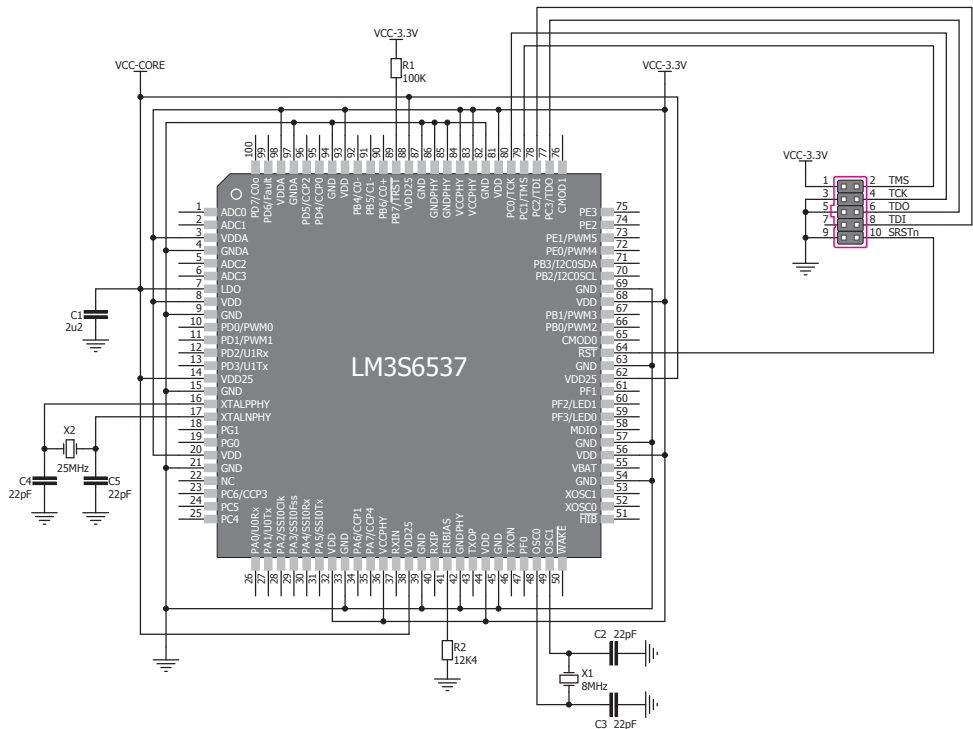

Figure 6-6: Connection schematic for 100-pin LM3S6537 MCU via 2x5 male header

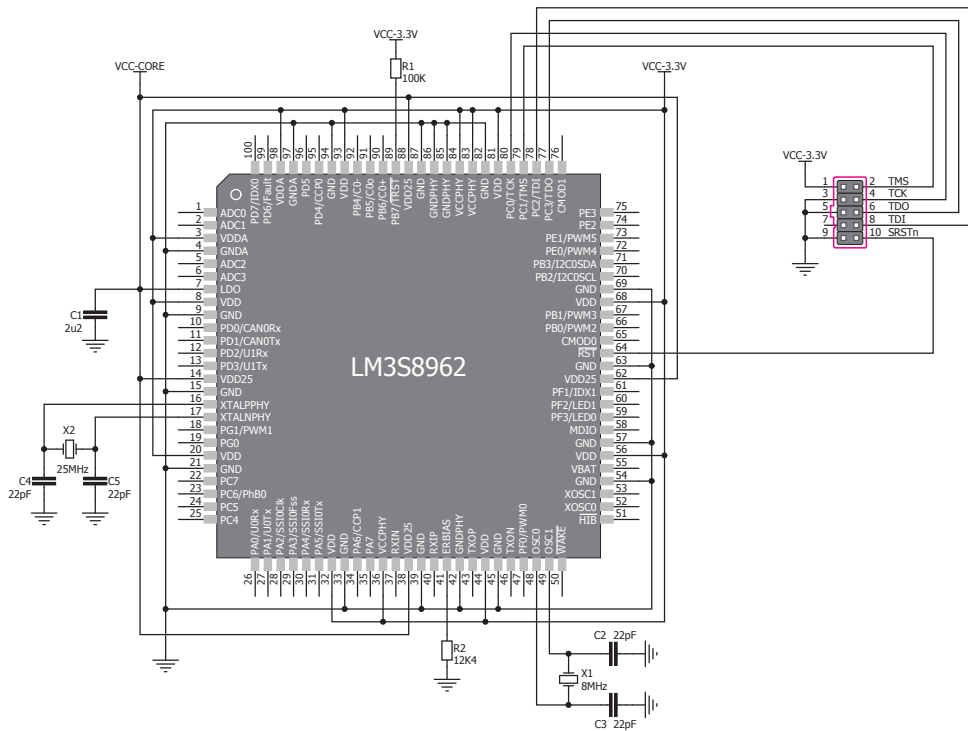

Figure 6-7: Connection schematic for 100-pin LM3S8962 MCU via 2x5 male header

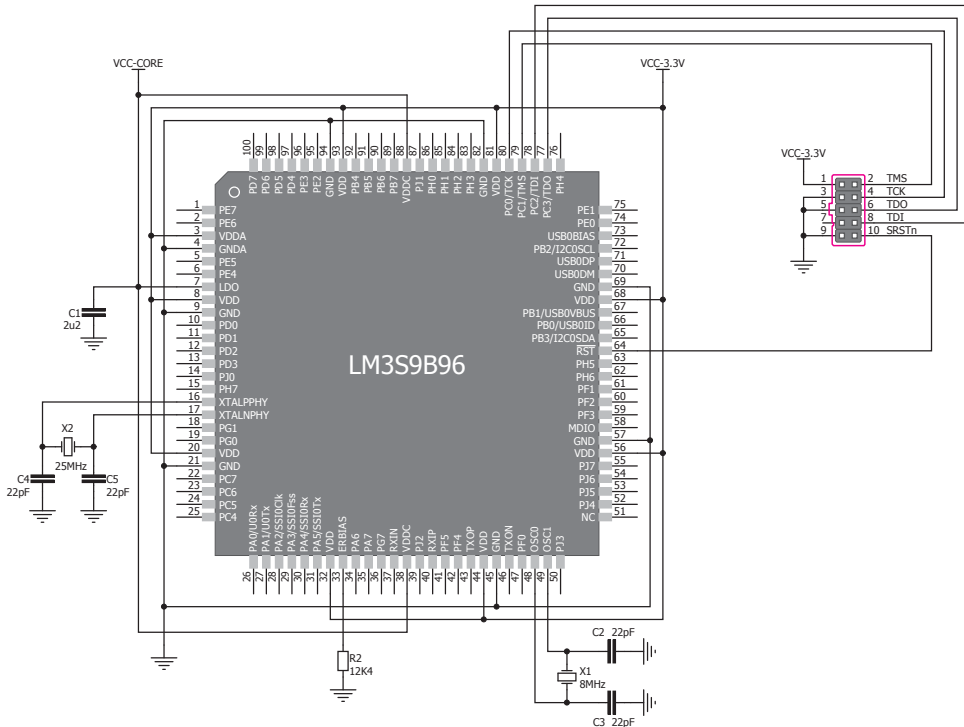

Figure 6-8: Connection schematic for 100-pin LM3S9B96 MCU via 2x5 male header

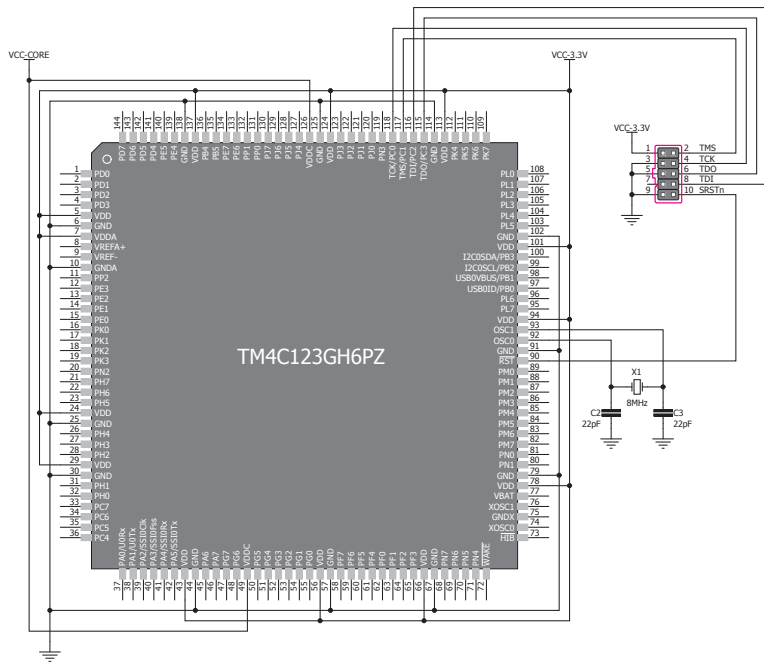

Figure 6-9: Connection schematics for 144-pin TM4C123GH6PZ MCU via 2x5 male header

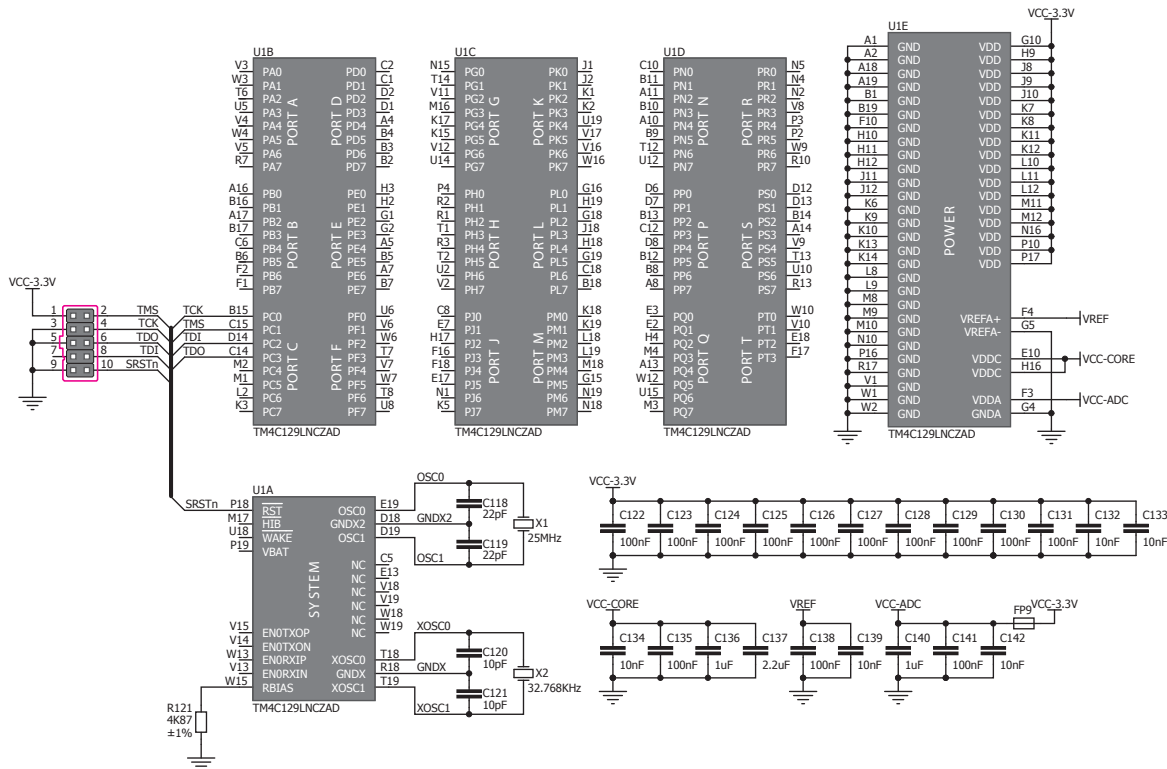
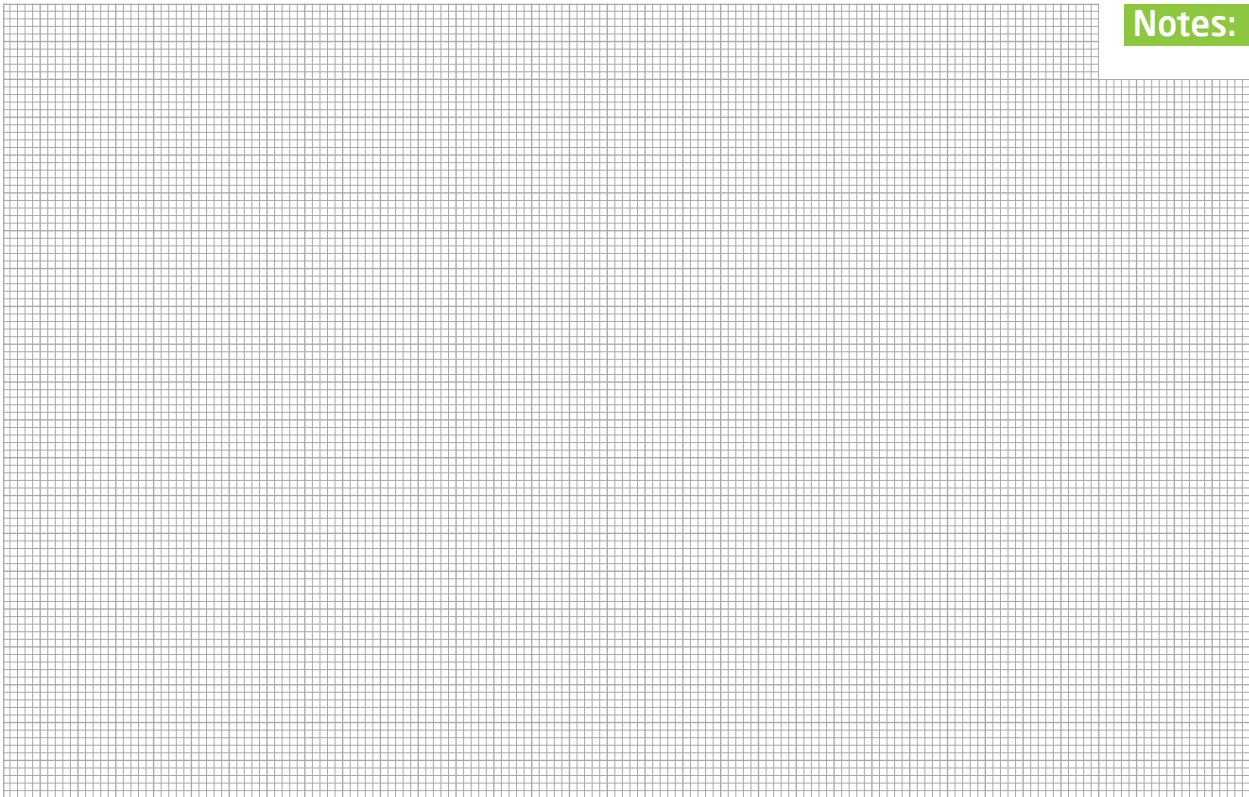

Figure 6-10: Connection schematic for 121-pin TM4C129LNCZAD MCU via 2x5 male header

Notes:



Notes:

DISCLAIMER

All the products owned by MikroElektronika are protected by copyright law and international copyright treaty. Therefore, this manual is to be treated as any other copyright material. No part of this manual, including product and software described herein, may be reproduced, stored in a retrieval system, translated or transmitted in any form or by any means, without the prior written permission of MikroElektronika. The manual PDF edition can be printed for private or local use, but not for distribution. Any modification of this manual is prohibited.

MikroElektronika provides this manual 'as is' without warranty of any kind, either expressed or implied, including, but not limited to, the implied warranties or conditions of merchantability or fitness for a particular purpose.

MikroElektronika shall assume no responsibility or liability for any errors, omissions and inaccuracies that may appear in this manual. In no event shall MikroElektronika, its directors, officers, employees or distributors be liable for any indirect, specific, incidental or consequential damages (including damages for loss of business profits and business information, business interruption or any other pecuniary loss) arising out of the use of this manual or product, even if MikroElektronika has been advised of the possibility of such damages. MikroElektronika reserves the right to change information contained in this manual at any time without prior notice, if necessary.

HIGH RISK ACTIVITIES

The products of MikroElektronika are not fault - tolerant nor designed, manufactured or intended for use or resale as on - line control equipment in hazardous environments requiring fail - safe performance, such as in the operation of nuclear facilities, aircraft navigation or communication systems, air traffic control, direct life support machines or weapons systems in which the failure of Software could lead directly to death, personal injury or severe physical or environmental damage ('High Risk Activities'). MikroElektronika and its suppliers specifically disclaim any expressed or implied warranty of fitness for High Risk Activities.

TRADEMARKS

The MikroElektronika name and logo, the MikroElektronika logo, mikroC™, mikroBasic™, mikroPascal™, mikroProg™, EasyMx PRO™ and mikromedia™ are trademarks of MikroElektronika. All other trademarks mentioned herein are property of their respective companies.

All other product and corporate names appearing in this manual may or may not be registered trademarks or copyrights of their respective companies, and are only used for identification or explanation and to the owners' benefit, with no intent to infringe.



If you want to learn more about our products, please visit our website at www.mikroe.com

If you are experiencing some problems with any of our products or just need additional information, please place your ticket at www.mikroe.com/support/

If you have any questions, comments or business proposals,
do not hesitate to contact us at office@mikroe.com

mikroProg for Tiva Manual
ver. 1.00



0 100000 025185

Mouser Electronics

Authorized Distributor

Click to View Pricing, Inventory, Delivery & Lifecycle Information:

[Mikroe:](#)

[MIKROE-1505](#)