

Click [here](#) to ask about the production status of specific part numbers.

## MAX77958 Evaluation Kit with 2S/3S Li+ 6A<sub>OUT</sub> Buck-Boost Charger

Evaluates: MAX77958, MAX77961

### General Description

The MAX77958 evaluation kit (EV kit) is a fully assembled and tested printed circuit board (PCB) that demonstrates the MAX77958 Standalone USB Type-C and Power Delivery Controller.

The EV kit enables easy evaluation of the following features:

- USB Type-C Detection/PD Communication (See [Table 1](#) for Acronyms)
  - Power Role (Sink and Source), Data Role (UFP and DFP) detection
  - PD Adapter Detection and PD Communication
  - Integrated V<sub>CONN</sub> Switch with OCP
  - Power/Data Role Swap
  - PPS (with PD Adapter Supporting PPS)
  - Audio and Debug Accessory Sink/Source Mode
  - Vendor Defined Message
- BC1.2 Legacy Charger Detection: SDP, CDP, DCP and DCD Timeout
- I<sup>2</sup>C Master to Control Companion IC
- Nine Configurable GPIOs (GPIO6 for SID)

The EV kit contains a MAX77961 charger to demonstrate the I<sup>2</sup>C master feature of the MAX77958. The MAX77961 is a buck-boost charger for 2S/3S Li+ battery application and is capable of 3.5V to 25V input voltage, with a maximum programmable fast charging current of 6A. The MAX77961 can be configured as the 2-cell or 3-cell application by the CONG pin resistor (R5), refer to the MAX77961 data sheet for more details.

The MAX16904 (a buck converter) is installed on the EV kit to provide 5V to V<sub>CONN</sub> pin. The MAX77958 uses GPIO2 to enable the buck converter when the MAX77958 is in SOURCE Power Role.

A Micro-B USB cable is included in the package to serve as the interface from a USB port on a Windows® PC to the slave I<sup>2</sup>C port on the MAX77958. A Windows based software provides a user-friendly interface to exercise the features of the MAX77958.

*Windows is a registered trademark and registered service mark of Microsoft Corporation.*

### Features

- High Voltage V<sub>BUS</sub> Range
- Short to V<sub>BUS</sub> Protection on CC Pins
- Type-C Support and USB-PD Support
  - Mode configuration: DFP/UFP/DRP
  - Type-C rev1.3 and PD3.0 Compatible
  - Cable Orientation and Power Role Detection
  - Integrated V<sub>CONN</sub> Switch with OCP
  - Support Try.Snk State
  - Support Audio
  - Support Debug Accessory Sink/Source Mode
  - FRS (Fast Role Swap) Initial Sink Support
  - PPS (Programmable Power Supply) Sink Support
- Support BC1.2 Legacy/Proprietary Charger Detection
  - Integrated D+/D- Switches
- MTP Memory for Storing Custom Configuration
- Moisture Detection and Corrosion Prevention
- Customization Script
- I<sup>2</sup>C Programmable Configuration
- I<sup>2</sup>C Master to Control External Charger or DC-DC Converter IC
- Nine Configurable GPIOs (GPIO6 for SID)
  - External SuperSpeed Mux/Detection/IRQ
  - EN/DISABLE External Power or FETs
- On-Board I<sup>2</sup>C Interface
- Windows 10 Compatible
- Proven PCB Layout
- Fully Assembled and Tested

[Ordering Information](#) appears at end of data sheet.

MAX77958 Evaluation Kit with 2S/3S  
Li+ 6A<sub>OUT</sub> Buck-Boost Charger

Evaluates: MAX77958, MAX77961

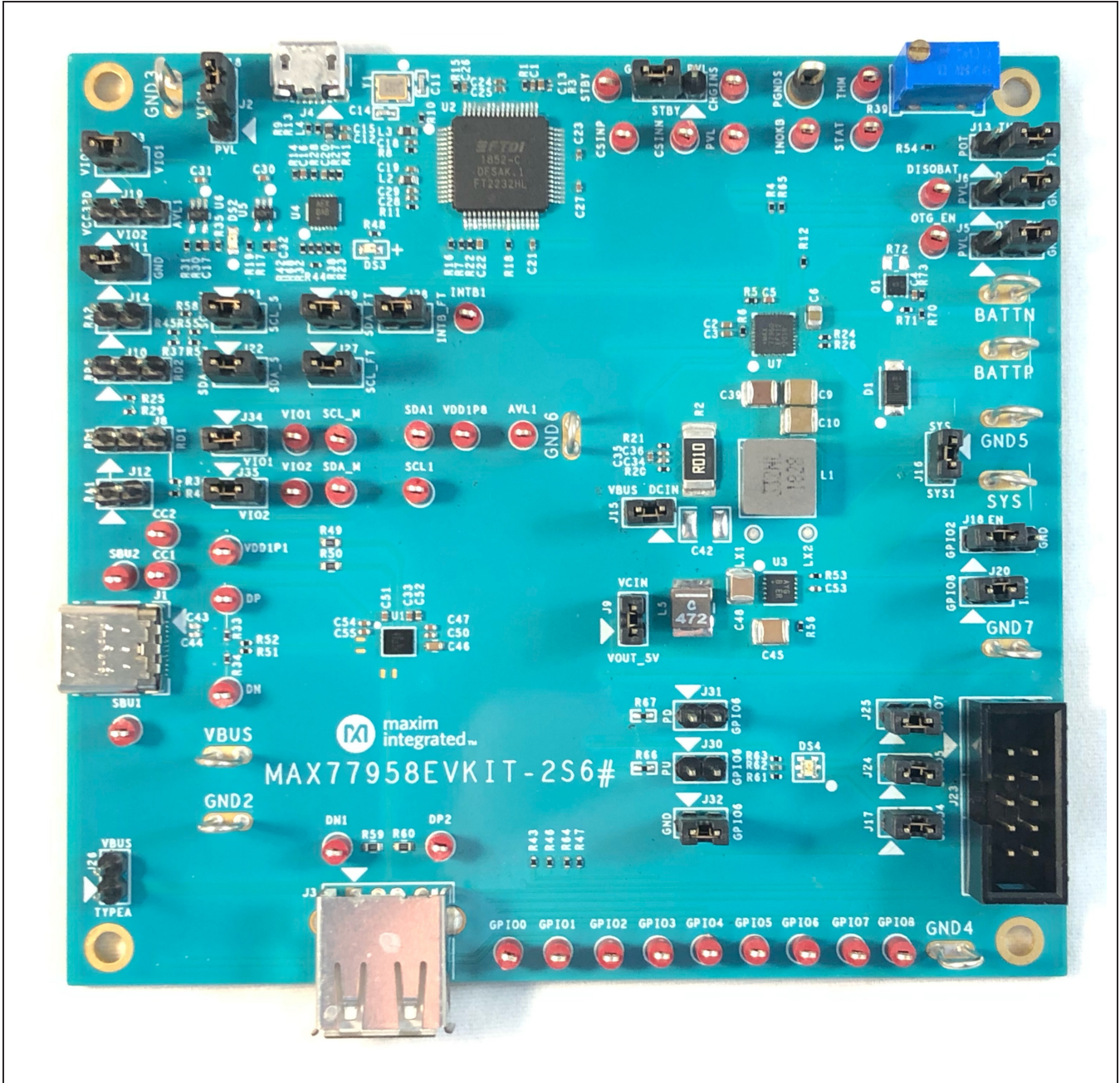

Figure 1. MAX77958 EV Kit-2S6/3S6#

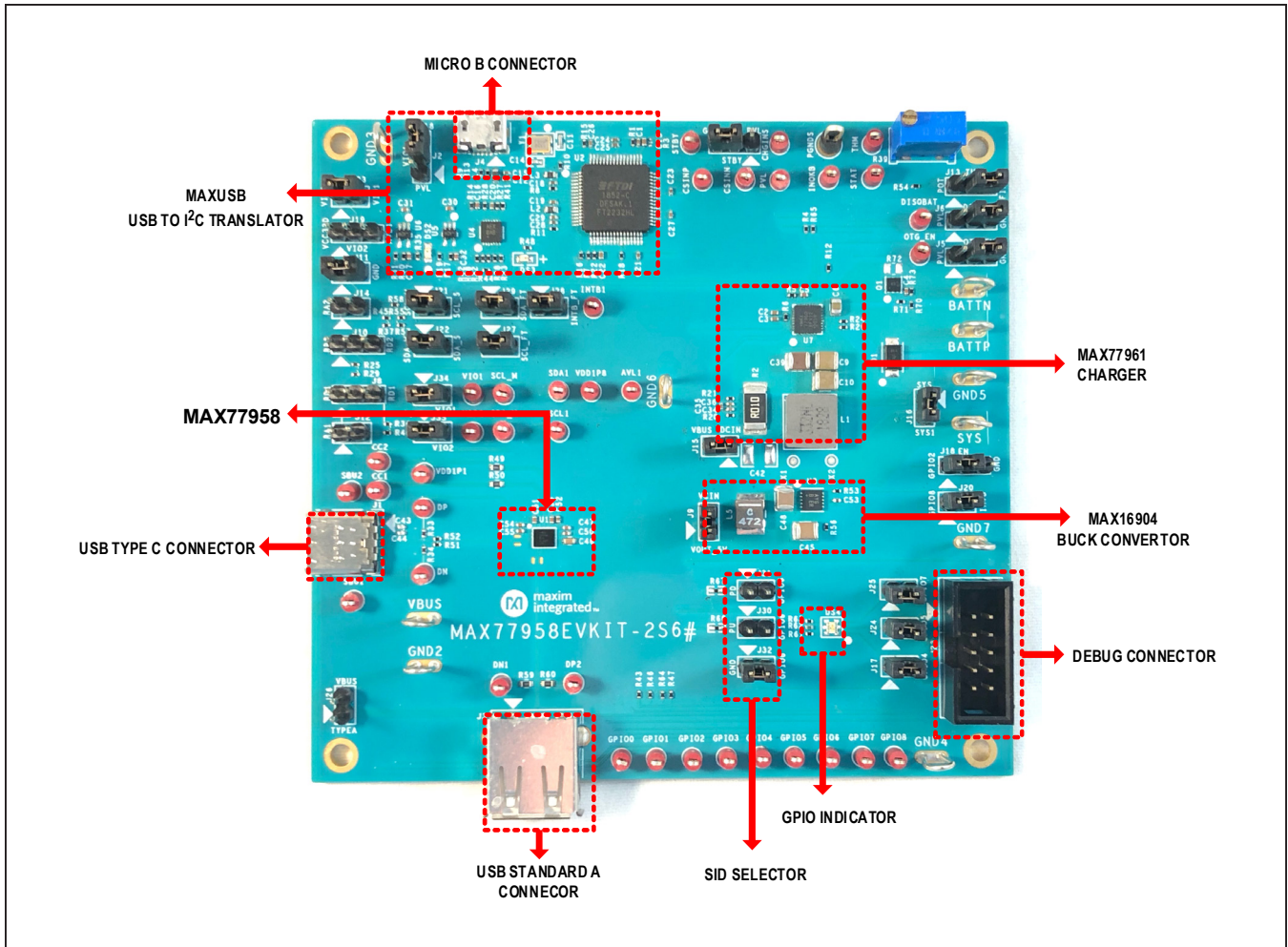

Figure 2. MAX77958 EV Kit-2S6/3S6# Top View

## Quick Start

### Required Equipment

- MAX77958 evaluation package
  - MAX77958EVKIT-2S6/3S6# Board
  - Micro-B USB cable
  - MAX77958 EV kit software (GUI)
- Type-C or PD travel adapter (TA)
- Power supply
- Battery simulator (or power supply with electronic load) after the battery simulator

- Multimeters
- Windows-based PC
- Oscilloscope to monitor CC pin or other signals

### Detailed Description of Hardware

The default settings of the jumpers configure the MAX77958 in Autonomous mode to control the MAX77961 to charge a 2S/3S Li+ battery. Review jumper settings in [Table 2](#) for other application scenarios.



**Table 1. Acronyms**

BC1.2	Battery Charging 1.2
CC	Configuration Channel
CDP	Charging Downstream Port
DCP	Dedicated Charging Port
DFP	Downstream Facing Port
EV kit	Evaluation kit
GPIO	General Purpose Input/Output
GUI	Graphical User Interface
I <sup>2</sup> C	Inter Integrated Circuit
IC	Integrated Circuit
MAXUSB	USB to I <sup>2</sup> C translator
MTP	Multiple Time Programmable
OVP	Over Voltage Protection
PCB	Printed Circuit Board
PD	Power Delivery
PDO	Power Data Object
PPS	Programmable Power Supply
SDP	Standard Downstream Port
UFP	Upstream Facing Port
USB	Universal Serial Bus
VDM	Vendor Defined Message

**Table 2. Jumper Descriptions and Default Positions**

DESCRIPTION	JUMPER NUMBER	DEFAULT POSITION	FUNCTION
VIO1 and VIO2 Connection	J2	Short 2-3	1-2 VIO1 is powered by the charger's PVL
			2-3 VIO1 is powered by the VCC1P8 LDO from the MAXUSB
	J19	Open	1-2 VIO2 is powered by the VCC3P3 LDO from the MAXUSB
			2-3 VIO2 is powered by the AVL of the MAX77958
	J33	Short 1-2	Open: VIO2 depends on the J19
			Short: connect VIO1 with VIO2
J34	Short 1-2	Open to disconnect VIO1 from the MAX77958	
J35	Short 1-2	Open to disconnect VIO2 from the MAX77958	

**Table 2. Jumper Descriptions and Default Positions (continued)**

DESCRIPTION	JUMPER NUMBER	DEFAULT POSITION	FUNCTION
USB Type-C Detection Test when no USB Type-C cable is connected	J11	Short 1-2	USB Type-C test, Rd and Ra connection to GND
	J8	Open	USB Type-C CC1 RP/RD connection
			1-2 connects RP to CC1
			2-3 connects RD to CC1
	J10	Open	USB Type-C CC2 RP/RD connection
			1-2 connects RP to CC2
			2-3 connects RD to CC2
J12	Open	Connects RA to CC1	
J14	Open	Connects RA to CC2	
V <sub>CONN</sub> Boost Enable	J9	Short 1-2	Connects 5V buck converter to V <sub>CONN</sub>
	J18	Short 1-2	Connects GPIO2 to the EN pin of the 5V buck converter to VCIN
V <sub>BUS</sub> from USB Type A Connector	J26	Open	USB Type-A connection to V <sub>BUS</sub>
LED Indicator	J17	Short 1-2	GPIO4 indicator LED connection
	J24	Short 1-2	GPIO5 indicator LED connection
	J25	Short 1-2	GPIO7 indicator LED connection
I <sup>2</sup> C _Master to MAX66961 from MAX77958	J20	Short 1-2	I <sup>2</sup> C _Master Interrupt input from the MAX77961
	J21	Short 1-2	I <sup>2</sup> C _Master SCL to MAX77961 from the MAX77958
	J22	Short 1-2	I <sup>2</sup> C _Master SDA to MAX77961 from the MAX77958
I <sup>2</sup> C _Slave to MAX-USB	J29	Short 1-2	I <sup>2</sup> C _Slave SDA to the MAXUSB
	J27	Short 1-2	I <sup>2</sup> C _Slave SCL to the MAXUSB
	J28	Short 1-2	I <sup>2</sup> C _Slave INTB to the MAXUSB
MAX77958 Slave ID Selector, one of the Jumper from J30 to J32 must be populated	J31	Open	Connect GPIO6 with an external 330kΩ pulldown resistor to GN; slave address = 0x4E
	J30	Open	Connect GPIO6 with an external 330kΩ pullup resistor to VIO1; slave address = 0x4C
	J32	Short 1-2	Connect GPIO6 to GND; slave address = 0x4A
MAX77961 Charger related jumpers	J5	Short 2-3	Charger OTG_EN
	J6	Short 2-3	Charger DISQBAT
	J7	Short 2-3	Charger STBY
	J13	Short 2-3	Charger THMBAT
	J15	Short 1-2	Charger input power DCIN to V <sub>BUS</sub>
	J16	Short 1-2	Connects charger System Voltage with USBC controller System Voltage

MAX77958 Evaluation Kit with 2S/3S  
Li+ 6A<sub>OUT</sub> Buck-Boost Charger

Evaluates: MAX77958, MAX77961

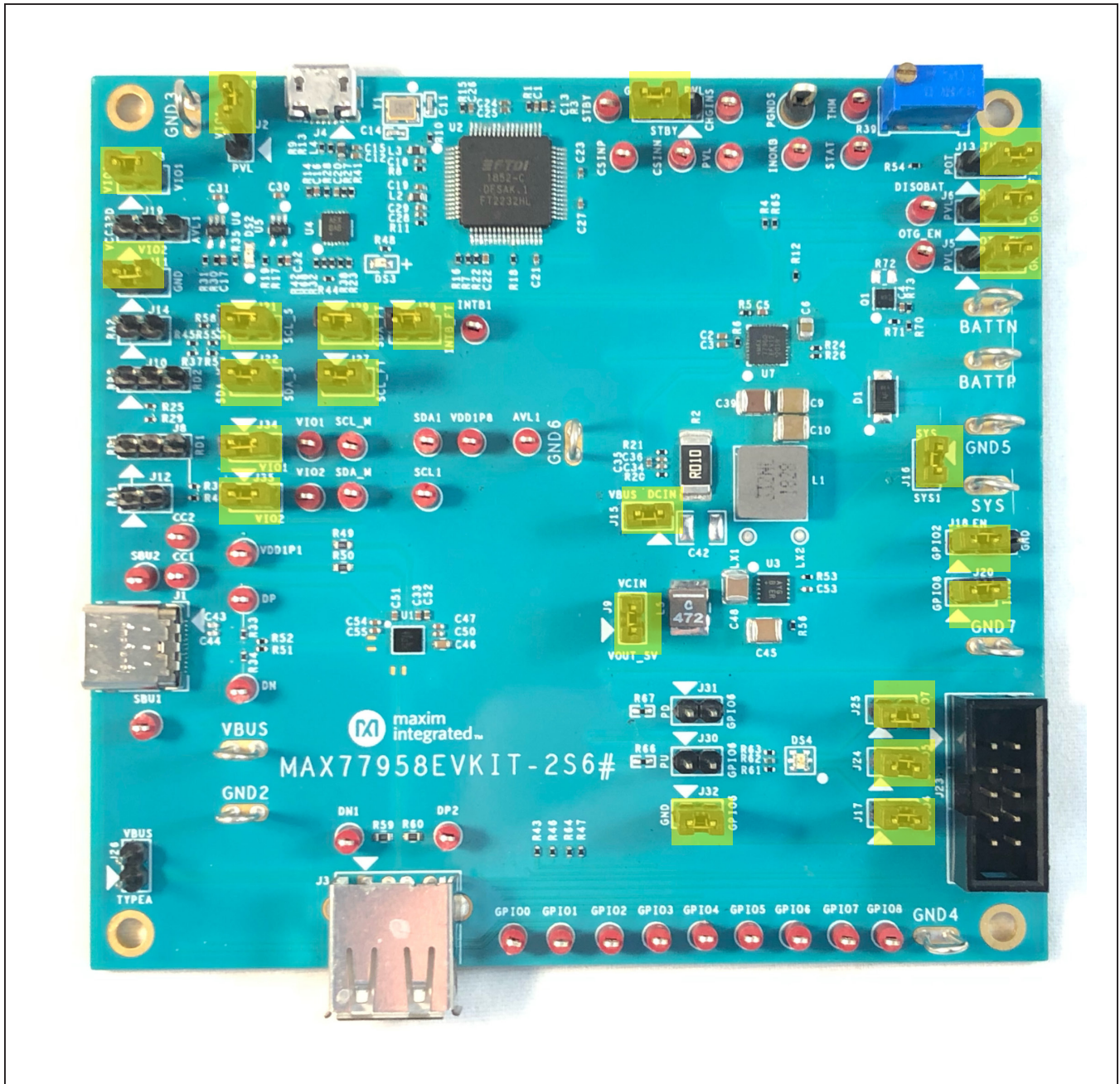

Figure 3. MAX77958 EV Kit-2S6/3S6# Top View with Default Jumpers Setup

# MAX77958 Evaluation Kit with 2S/3S Li+ 6A<sub>OUT</sub> Buck-Boost Charger

Evaluates: MAX77958, MAX77961

## Detailed Description of Software

The GUI allows for quick, easy, and thorough evaluation of the MAX77958. Every control in the GUI corresponds to a register in the MAX77958. Refer to the *Register Map* section in the MAX77958 data sheet for a complete description.

## Installation

The MAX77958EVKIT GUI can be downloaded from Maxim's website at <http://www.maximintegrated.com/products/MAX77958> (under the *Design & Development*

tab). Save the EV kit software to a temporary folder and decompress the ZIP file. Run the .EXE file and follow the on-screen instructions to complete the installation.

## Windows Driver

After connecting the Micro-USB cable between a PC and the EV kit for the first time, wait for Windows to automatically install the drivers for the USB to I<sup>2</sup>C Interface.

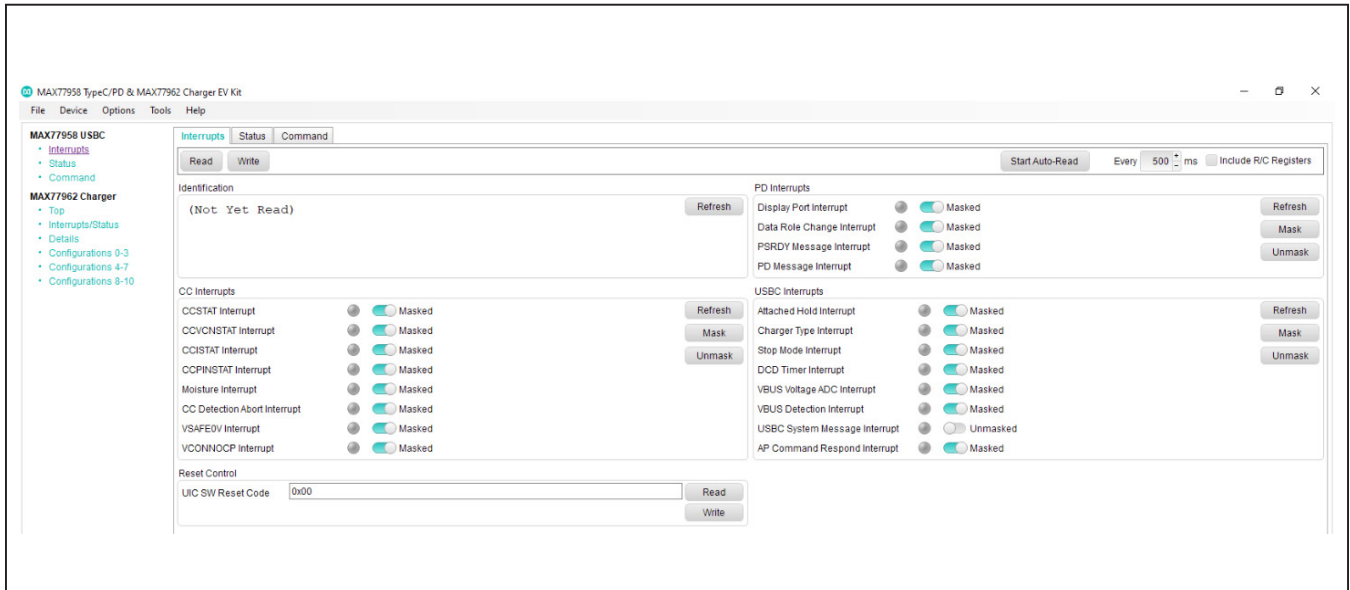

Figure 4. MAX77958 Evaluation Kit Software

## Test Procedure

The EV kit is fully assembled and tested. The following test procedure is based on the 2S application. For 3S applications, increase the battery voltage from 7V to 10.5V. Use the following steps to verify board operation.

### Autonomous Mode 2S/3S Application

#### SINK Mode

When the MAX77958 is configured as the SINK, the MAX77958 enables the charger mode of the MAX77961 and set the input current limit of the MAX77961 according to the USB Type-C and BC1.2 detection result.

- 1) Connect the battery simulator between BATTP and BATTN, adjust the voltage to 7V and turn it on.
- 2) Connect USB Type-C AC adapter into the EV kit.
- 3) Observe the current reading from the battery simulator. The MAX77958 sets the input current limit of the charger based on the CC detection result. (If the battery simulator is not available, use the power supply in parallel with the electronic load to test.)

#### SOURCE Mode

When the MAX77958 is configured as the SOURCE, the MAX77961 automatically switches to reverse-buck mode, and supplies 5.1V to V<sub>BUS</sub>.

- 1) Connect the battery simulator between BATTP and BATTN, adjust the voltage to 7V and turn it on.
- 2) Make sure no USB Type-C cable is connected.
- 3) Short Pin1-2 of J11 and short Pin2-3 of J8 to connect a 5.1kΩ R<sub>d</sub> to CC1.
- 4) Monitor the voltage of V<sub>BUS</sub> and check whether it equals 5.1V.

## Initial Test Setup

- 1) Do not turn on the DC power supplies until all connections are made.
- 2) Confirm all jumpers are at their default positions as indicated in [Table 2](#).
- 3) Connect a Micro-B USB cable from the computer's USB port to the MAX77958 EV kit.
- 4) Connect the DC power supply to the loop labeled SYS and GND.
- 5) Adjust the DC power supply to 7V and turn it on.
- 6) Follow the description of software covered in page 7 to install the MAX77958EVKIT.EXE software program.
- 7) Open the MAX77958 GUI and go to the **Device** drop-down menu, and press the **Connect** button in the drop-down list.
- 8) Wait for the device to respond and click on the **Read** and **Close** button to continue.
- 9) The EV kit and GUI are now ready for use.

## CC Detection Test

- 1) Connect USB Type-C adapter into the EV kit and see whether the MAX77958 detects **SINK** and configures input current limit correctly.
- 2) Connect USB Type-C cable from a Type-C dual role port (Source Preferred) device to see whether the MAX77958 detects **CC Pin State Machine Detection** and configures input current limit correctly.

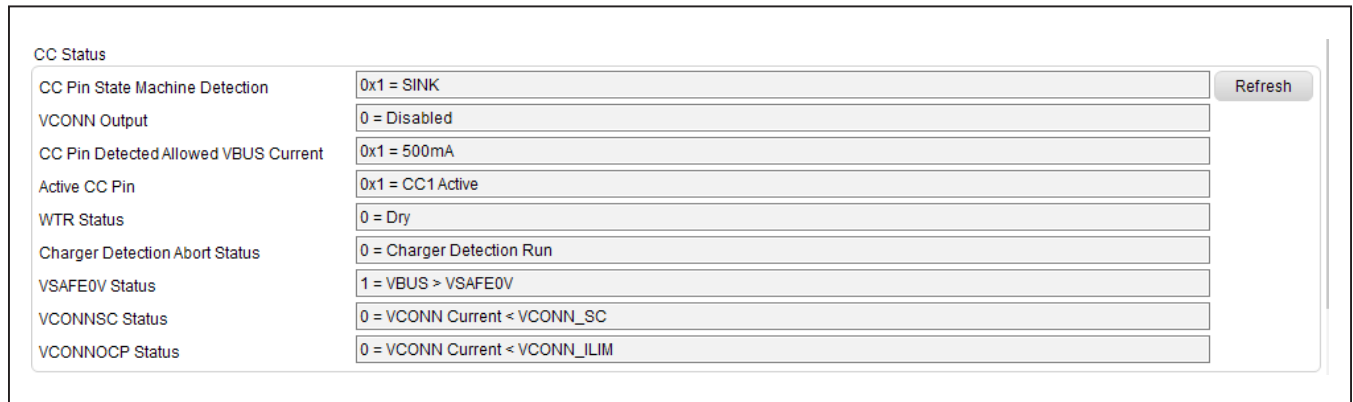

Figure 5. CC Status After Connecting the USB Type-C Connector of EV Kit to a Travel Adapter (TA)



### USB Power Delivery Test

Source capability request function test.

- 1) Connect USB Power delivery AC Adapter into the EV kit.
- 2) Use a voltmeter to monitor the voltage on V<sub>BUS</sub>.
- 3) Go to Command > **Get SrcCap (0x31)**, click on **Write** button execute the command, the MAX77958 sends this command over the CC pin to the TA, the TA provides a list of available source capabilities.
- 4) Review the source capabilities and make a note of the desired PDO.

- 5) Go to **SrcCap Request (0x32)**, set the value of the PDO and press the **Write** button to change the BUS voltage.

### BC1.2 Charger Type Detection

- 1) Plug in the USB Type-A to Type-C cable from a BC1.2 adapter or other legacy port, check the **Charger Detection Status** under the status tab of the MAX77958 GUI, to see if the USBC detects the correct charger type.

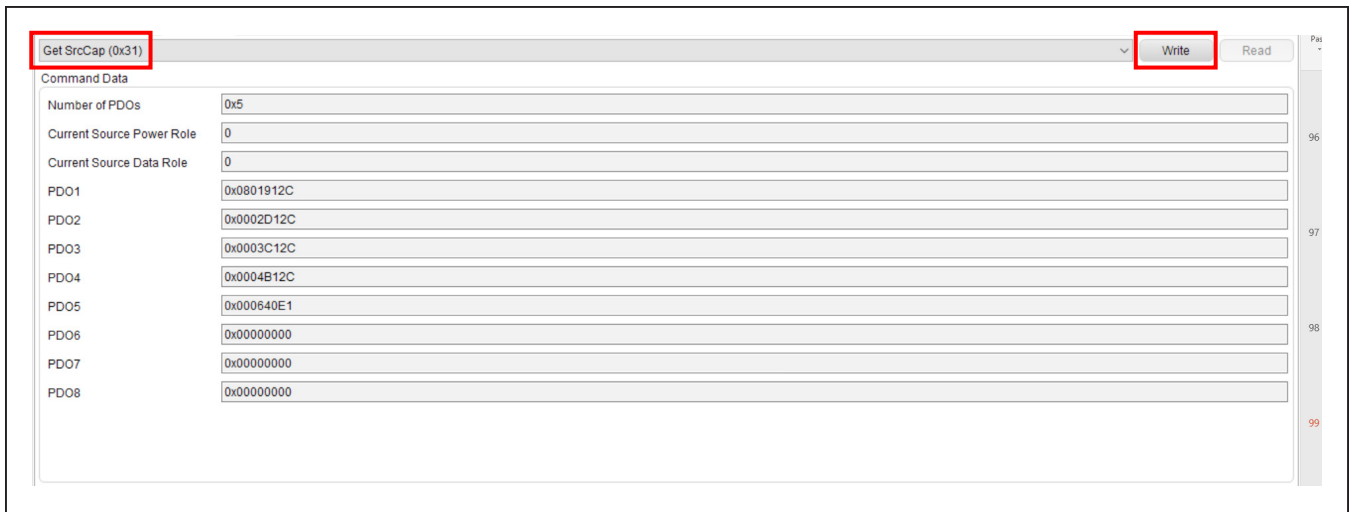

Figure 6. Get Source Capability (Get SrcCap) under Command Section

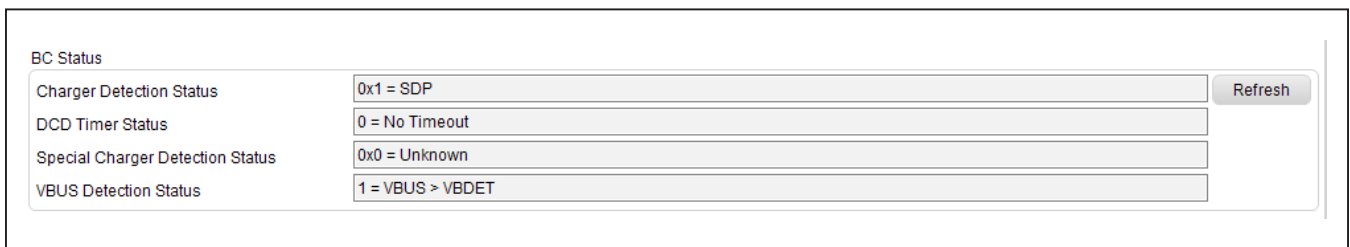

Figure 7. BC Status After Connecting the USB Type-C Connector of EV Kit to SDP

# MAX77958 Evaluation Kit with 2S/3S Li+ 6A<sub>OUT</sub> Buck-Boost Charger

Evaluates: MAX77958, MAX77961

## I<sup>2</sup>C Master Test

The MAX77961 buck-boost charger IC is installed on the EV kit and communicates with the MAX77958 through the master I<sup>2</sup>C interface. When the MAX77958 is configured as the source, the MAX77961 automatically switches to reverse-buck mode, and supplies 5.1V to V<sub>BUS</sub>.

- 1) Disconnect Type-C cable.
- 2) Connect 7V power supply to BATT+.
- 3) Connect the pin 2-3 of Jumper 10, to attach the Rd to the CC2.
- 4) Check the **CC Status** in GUI, the MAX77958 should be in **SOURCE** mode.
- 5) MAX77961 is under the OTG mode, the measured V<sub>BUS</sub> voltage should equal to 5.1V.

## Detailed Description of Firmware

The firmware of the MAX77958 consists of two main parts: the core firmware and customization script.

The core firmware is compliant with the USB Type-C 1.3 and PD 3.0 specifications. The customization script is based on application system, giving more flexibility for system design. It is based on the customization script update, which can achieve functions such as GPIO matrix control, charger configuration initialization, etc.

Future USB Type-C and PD specifications changes can be accommodated by updating the MAX77958 core firmware. See the [Core Firmware Update](#) section of this data sheet.

See the MAX77958 customization script and OPCode command guide for details about the customization script.

## Customization Script Block Update

The customization script defines the application specific behavior of the MAX77958. An example is setting the input current limit of the charger when the USB device detection is completed.

- 1) Follow the initial test setup to connect the GUI with the MAX77958 EV kit.
- 2) Connect 7.0V to SYS, do not disconnect the EV kit from the PC during the **Customization Script Block Update**.
- 3) Click on **Tools** in the menu bar and then go to **CUS Command Block Update**.
- 4) Click on the **Open** button in the pop up window to load the latest customization script and then click on **Start** to activate the **Customization Script Update**.
- 5) [Figure 10](#) shows the completion of the customization script update process.

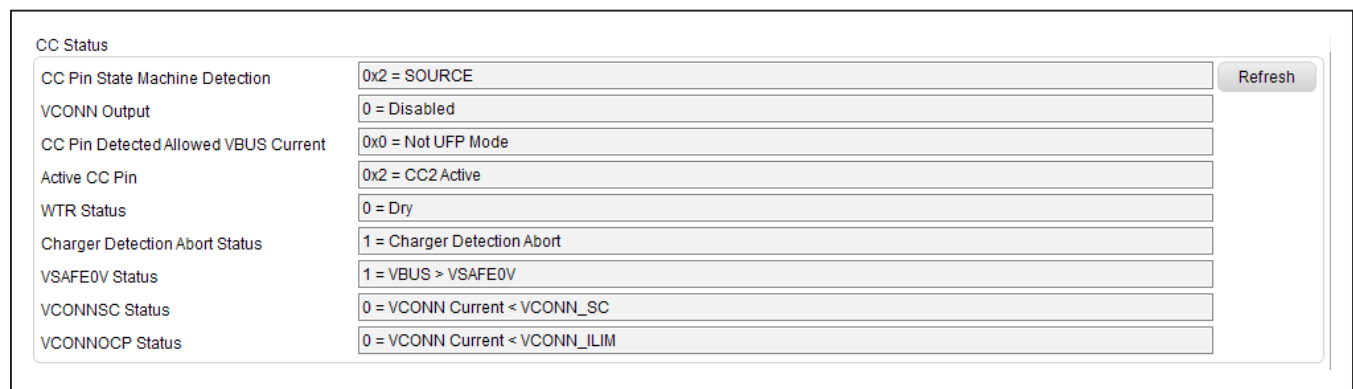

Figure 8. CC Status After Attaching Rd to CC2

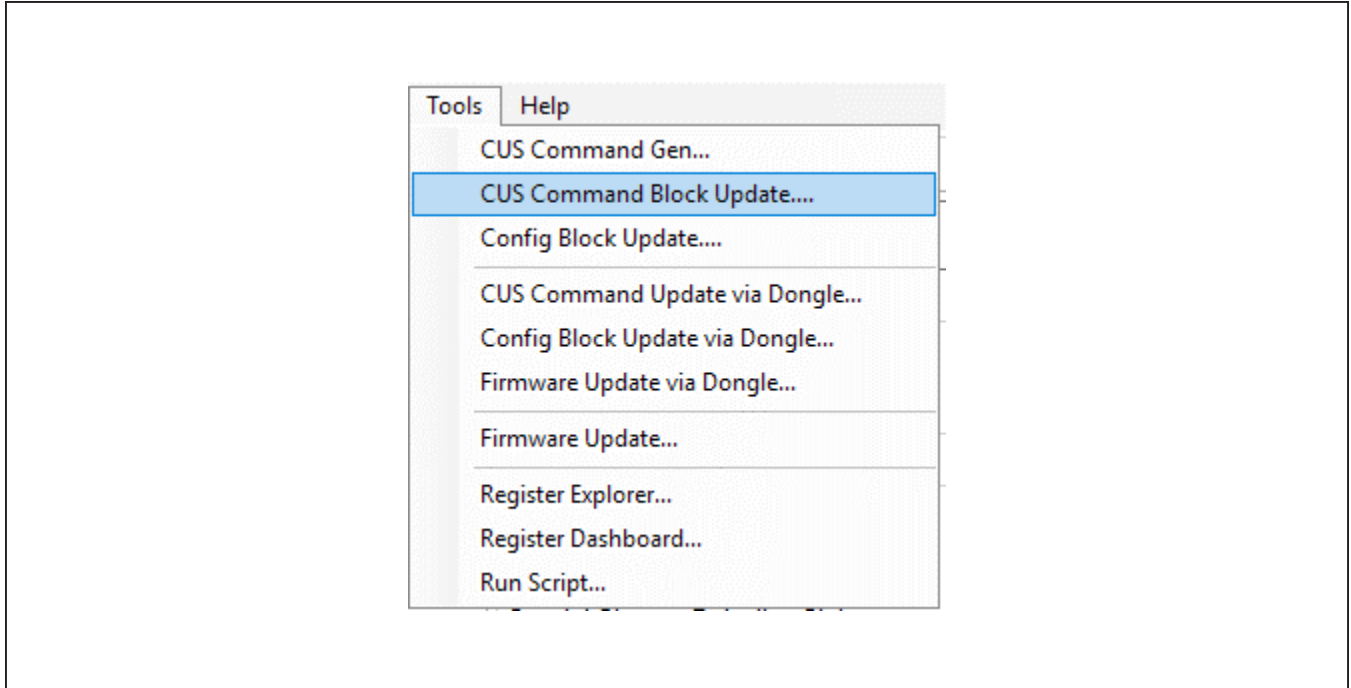

Figure 9. GUI Customization Script Block Update

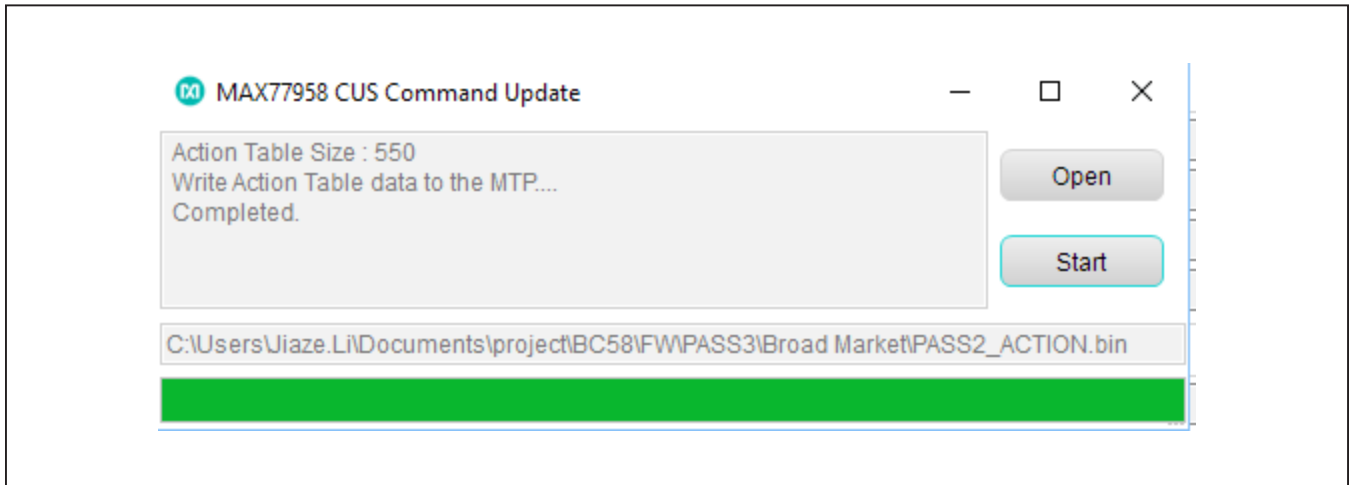

Figure 10. Customization Script Update Process Complete

### Core Firmware Update

- 1) Follow the initial test setup to connect the GUI with the MAX77958 EV kit.
- 2) Connect 7.0V to SYS, do not disconnect the EV kit from the PC during the **Firmware Update**.
- 3) Click on **Tools** in the menu bar and then go to **Firmware Update**.
- 4) Click on the **Open** button in the pop up window to load the latest firmware, in the file select window click on the .bin file, and then select **Start** to activate the **Firmware Update**.
- 5) [Figure 12](#) shows the firmware update process is completed.

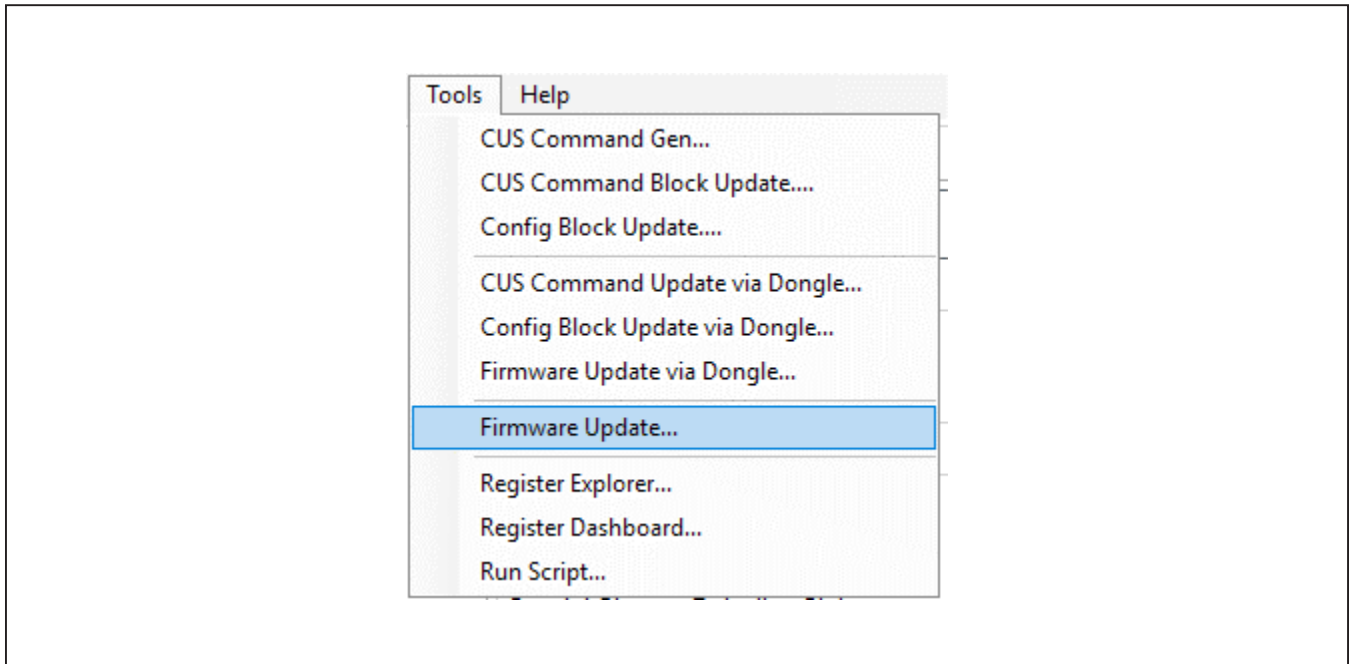

Figure 11. GUI Firmware Update

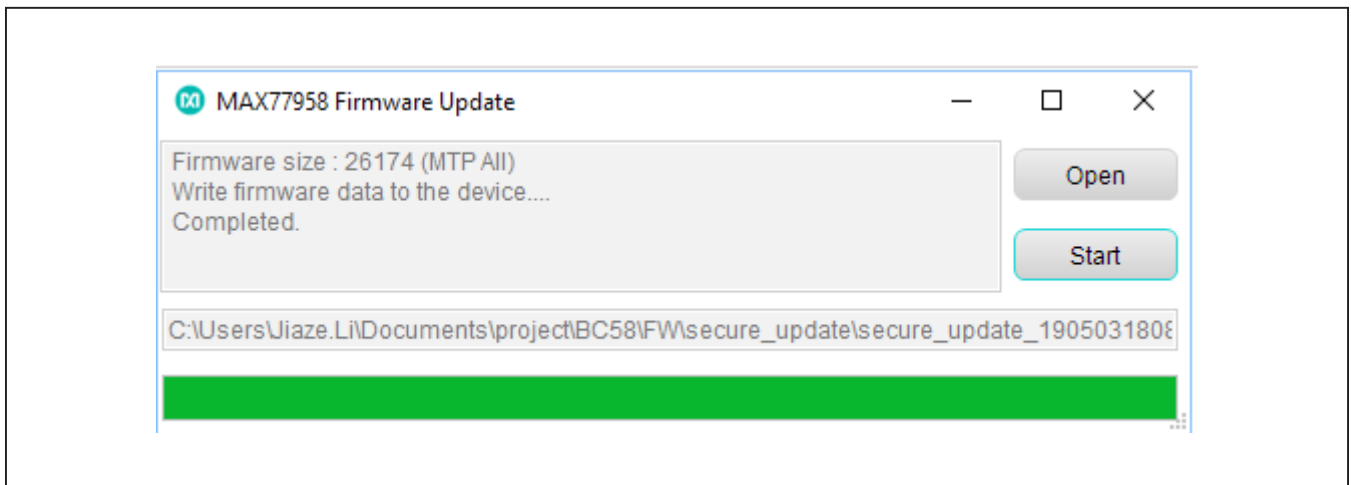

Figure 12. Firmware Update Process Complete



## MAX77958 Evaluation Kit with 2S/3S Li+ 6A<sub>OUT</sub> Buck-Boost Charger

Evaluates: MAX77958, MAX77961

### Component Suppliers

SUPPLIER	PHONE	WEBSITE
MURATA	770-436-1300	www.murata-northamerica.com
SAMTEC	800-726-8329	www.samtec.com
SULLINS ELECTRONICS CORP.	760-774-0125	www.sullinselectronics.com
TAIYO-YUDEN	603-669-7587	www.t-yuden.com
TDK	847-803-6100	www.tdk.com/corp/en/index.htm
VISHAY	408-970-5852	www.vishay.com
CYNTEC	510-668-5167	www.cyntec.com
PANASONIC	800-344-2112	www.na.industrial.panasonic.com/
FUTURE TECHNOLOGY DEVICES INTL LTD.	503-547-0988	www.ftdichip.com

**Note:** Indicate that you are using the MAX77958 when contacting these component suppliers.

### Ordering Information

PART NUMBER	IC	TYPE
MAX77958EVKIT-2S6#	MAX77958EWW+ MAX77961EFV06+	EV Kit
MAX77958EVKIT-3S6#	MAX77958EWW+ MAX77961EFV06+	EV Kit

#Denotes RoHS compliance.

+Denotes a lead(Pb)-free/RoHS-compliant package.

MAX77958 Evaluation Kit with 2S/3S  
Li+ 6A<sub>OUT</sub> Buck-Boost Charger

Evaluates: MAX77958, MAX77961

MAX77958-2S/3S EV Kit Bill of Materials

ITEM	REF_DES	QTY	MFG PART #	VALUE	DESCRIPTION
1	AVL1, CC1, CC2, CHGINS, CSINN, CSINP, DISQBAT, DN, DN1, DP, DP2, GPIO0-GPIO8, INOKB, INTB1, OTG_EN, PVL, SBU1, SBU2, SCL1, SCL_M, SDA1, SDA_M, STAT, STBY, THM, VDD1P1, VDD1P8, VIO1, VIO2	37	5000	N/A	TEST POINT; PIN DIA=0.1IN; TOTAL LENGTH=0.3IN; BOARD HOLE=0.04IN; RED; PHOSPHOR BRONZE WIRE SILVER PLATE FINISH;
2	BATTN, BATTP, GND2-GND7, SYS, VBUS	10	9020 BUSS	MAXIMPAD	EVK KIT PARTS; MAXIM PAD; WIRE; NATURAL; SOLID; WEICO WIRE; SOFT DRAWN BUS TYPE-S; 20AWG
3	C1, C15, C18-C21, C23-C29, C35	14	GRM155R71A104JA01	0.1UF	CAPACITOR; SMT (0402); CERAMIC; 0.1UF; 10V; TOL=5%; TG=-55 DEGC TO +125 DEGC; TC=X7R
4	C2, C3, C12, C13, C22	5	ZRB15XR61A475ME01; CL05A475MP5NRN; GRM155R61A475MEAA; C1005X5R1A475M050BC	4.7UF	CAPACITOR; SMT (0402); CERAMIC; 4.7UF; 10V; TOL=20%; TG=-55 DEGC TO +85 DEGC; TC=X5R
5	C4	1	C1005X7R1E473K050BC; GRM155R71E473K; GCM155R71E473KA55	0.047UF	CAPACITOR; SMT (0402); CERAMIC; 0.047UF; 25V; TOL=10%; TG=-55 DEGC TO +125 DEGC
6	C5	1	GRM155C81E105KE11	1UF	CAPACITOR; SMT (0402); CERAMIC; 1UF; 25V; TOL=10%; TG=-55 DEGC TO +105 DEGC; TC=X6S
7	C6	1	GRM21BR61E106K; C2012X5R1E106K085AC125AB; C2012X5R1E106K085AC;TMK212BBJ106KG; CL21A106KAFN3N	10UF	CAPACITOR; SMT (0805); CERAMIC; 10UF; 25V; TOL=10%; MODEL=; TG=-55 DEGC TO +85 DEGC; TC=X5R
8	C7, C8	2	GRM155R71C224KA12	0.22UF	CAPACITOR; SMT (0402); CERAMIC; 0.22UF; 16V; TOL=10%; MODEL=GRM SERIES; TG=-55 DEGC TO +125 DEGC; TC=X7R
9	C9, C10	2	TMK325ABJ476MM	47UF	CAP; SMT (1210); 47UF; 20%; 25V; X5R; CERAMIC
10	C11, C14, C43, C44	4	C0402C0G500270JNP; GRM1555C1H270JA01	27PF	CAPACITOR; SMT; 0402; CERAMIC; 27pF; 50V; 5%; COG; -55degC to + 125degC; 0 +/-30PPM/degC
11	C16, C17, C30-C32	5	C0402C105K8PAC;CC0402KRX5R6BB105	1UF	CAPACITOR; SMT (0402); CERAMIC; 1UF; 10V; TOL=10%; TG=-55 DEGC TO +85 DEGC; TC=X5R
12	C33, C47, C51, C54, C55	5	ANY	1UF	CAPACITOR; SMT (0402); CERAMIC CHIP; 1UF; 6.3V; TOL=10%; MODEL=; TG=-55 DEGC TO +85 DEGC; TC=X5R;
13	C34, C36	2	GRM155R71H153KA12	0.015UF	CAPACITOR; SMT (0402); CERAMIC; 0.015UF; 50V; TOL=10%; TG=-55 DEGC TO +125 DEGC; TC=X7R
14	C39, C45	2	GRM32ER7YA106KA12; CL32B106KLULNN	10UF	CAPACITOR; SMT (1210); CERAMIC; 10UF; 35V; TOL=10%; TG=-55 DEGC TO +125 DEGC; TC=X7R
15	C46	1	GRM188R71A225KE15;CL10B225KP8NNN; C1608X7R1A225K080AC;C0603C225K8RAC	2.2UF	CAPACITOR; SMT (0603); CERAMIC; 2.2UF; 10V; TOL=10%; TG=-55 DEGC TO +125 DEGC; TC=X7R
16	C48	1	C1210C475K5RAC;GRM32ER71H475KA88;CNC 6P1X7R1H475K250AE	4.7UF	CAPACITOR; SMT (1210); CERAMIC; 4.7UF; 50V; TOL=10%; TG=-55 DEGC TO +125 DEGC; TC=X7R
17	C49	1	TMK105BJ104KV; GRM155R61E104KA87	0.1UF	CAPACITOR; SMT (0402); CERAMIC; 0.1UF; 25V; TOL=10%; TG=-55 DEGC TO +85 DEGC; TC=X5R
18	C50, C52	2	C1005X5R1V105K050BC	1UF	CAPACITOR; SMT (0402); CERAMIC; 1UF; 35V; TOL=10%; TG=-55 DEGC TO +85 DEGC; TC=X5R
19	C53	1	ZRB157R61A225KE11; GRM155R61A225KE95;CL05A225KP5NSN	2.2UF	CAPACITOR; SMT (0402); CERAMIC; 2.2UF; 10V; TOL=10%; TG=-55 DEGC TO +85 DEGC; TC=X5R
20	D1	1	PMEG4050EP	PMEG4050EP	DIODE; SCH; SMT (SOD-128); PIV=40V; IF=5A
21	DS2	1	LTST-C190CKT	LTST-C190CKT	DIODE; LED; STANDARD; RED; SMT (0603); PIV=5.0V; IF=0.04A; -55 DEGC TO +85 DEGC
22	DS3	1	LTST-C190KFK	LTST-C190KFK	DIODE; LED; ULTRA BRIGHT CHIP LEAD; ORANGE; SMT (0603); VF=2V; IF=0.02A
23	DS4	1	19-337/R6GHBHC-A01/2T	19-337/R6GHBHC-A01/2T	DIODE; LED; SMD-B; RED/GREEN/BLUE; SMT; PIV=2V-3.3V; IF=0.02A
24	J1	1	12401832E402A	12401832E402A	CONNECTOR; FEMALE; SMT; USB TYPE C CONNECTOR; RIGHT ANGLE; DUAL ROW; 24PINS
25	J2, J5-J8, J10, J13, J18, J19	9	PEC03SAAN	PEC03SAAN	EVKIT PART-CONNECTOR; MALE; THROUGH HOLE; BREAKAWAY; STRAIGHT; 3PINS; -65 DEGC TO +125 DEGC;
26	J3	1	87520-0010BLF	87520-0010BLF	CONNECTOR; FEMALE; THROUGH HOLE; USB RECEPTACLE; RIGHT ANGLE; 4PINS
27	J4	1	10118193-0001LF	10118193-0001LF	CONNECTOR; FEMALE; SMT; MICRO USB B TYPE RECEPTACLE; RIGHT ANGLE; 5PINS
28	J9, J11, J12, J14-J17, J20-J22, J24-J35	22	TSW-102-07-T-S	TSW-102-07-T-S	CONNECTOR; THROUGH HOLE; TSW SERIES; SINGLE ROW; STRAIGHT; 2PINS; -55 DEGC TO +105 DEGC
29	J23	1	SBH11-PBPC-D05-ST-BK	SBH11-PBPC-D05-ST-BK	CONNECTOR; MALE; THROUGH HOLE; 0.100IN MALE SHROUDED BOX HEADER; STRAIGHT; 10PINS
30	L1	1	PA5007.332NLT	3.3UH	INDUCTOR; SMT; COMPOSITE; 3.3UH; 20%; 10A
31	L2-L4	3	BLM18AG601SN1	600	INDUCTOR; SMT (0603); FERRITE-BEAD; 600; TOL=+/-; 0.5A
32	L5	1	XFL4020-472ME	4.7UH	INDUCTOR; SMT; METAL COMPOSITE CORE; 4.7UH; TOL=+/-20%; 5A; -40 DEGC TO +125 DEGC
33	PGNDS	1	5011	N/A	TEST POINT; PIN DIA=0.125IN; TOTAL LENGTH=0.445IN; BOARD HOLE=0.063IN; BLACK; PHOSPHOR BRONZE WIRE SILVER PLATE FINISH;
34	Q1	1	DMN3016LFDE	DMN3016LFDE	TRAN; NCH; U-DFN2020-6 (TYPE E); PD-(0.73W); I-(10A); V-(30V)

MAX77958 Evaluation Kit with 2S/3S  
Li+ 6A<sub>OUT</sub> Buck-Boost Charger

Evaluates: MAX77958, MAX77961

MAX77958-2S/3S EV Kit Bill of Materials (continued)

ITEM	ITEM	ITEM	ITEM	ITEM	ITEM
35	R1, R7, R14-R16, R18, R22, R24, R26, R32-R34, R44, R68	14	ERJ-2GE0R00	0	RESISTOR; 0402; 0 OHM; 0%; JUMPER; 0.10W; THICK FILM
36	R2	1	CRA2512-FZ-R010ELF	0.01	RESISTOR; 2512; 0.01 OHM; 1%; 75PPM; 3.0W; THICK FILM
37	R4, R23, R58, R65	4	CRCW0402200KFK; RF73H1ELTP2003	200K	RESISTOR; 0402; 200K; 1%; 100PPM; 0.0625W; THICK FILM
38	R5 for 2S application	1	ERJ-2RKF8662	86.6K	RESISTOR; 0402; 86.6K OHM; 1%; 100PPM; 0.1W; THICK FILM
	R5 for 3S application	1	ERJ-2RKF8661	8.66K	RESISTOR; 0402; 8.66K OHM; 1%; 100PPM; 0.1W; THICK FILM
39	R6	1	ERJ-2GEJ4R7	4.7	RESISTOR; 0402; 4.7 OHM; 5%; 200PPM; 0.10W; THICK FILM
40	R8	1	CRCW040212K0FK;MCR01MZPF1202	12K	RESISTOR; 0402; 12K OHM; 1%; 100PPM; 0.0625W; THICK FILM
41	R9, R13	2	ERJ-2RKF27R0X;RC0402FR-0727RL;CRCW040227R0FK	27	RESISTOR; 0402; 27 OHM; 1%; 100PPM; 0.0625W; THICK FILM
42	R10	1	CRCW04021M00FK	1M	RESISTOR; 0402; 1M; 1%; 100PPM; 0.0625W; THICK FILM
43	R11, R40, R45, R71	4	CRCW04021K00FK; RC0402FR-071KL;MCR01MZPF1001	1K	RESISTOR; 0402; 1K; 1%; 100PPM; 0.0625W; THICK FILM
44	R12, R54	2	CRCW040210K0FK;RC0402FR-0710KL	10K	RESISTOR; 0402; 10K; 1%; 100PPM; 0.0625W; THICK FILM
45	R17	1	CRCW04024752FK; 9C04021A4752FLHF3; CRCW040247K5FK	47.5K	RESISTOR; 0402; 47.5K; 1%; 100PPM; 0.0625W; THICK FILM
46	R19, R31, R41	3	CRCW0402100KFK;RC0402FR-07100KL	100K	RESISTOR; 0402; 100K; 1%; 100PPM; 0.0625W; THICK FILM
47	R20, R21	2	CRCW040210R0FK; 9C04021A10R0FL	10	RESISTOR; 0402; 10 OHM; 1%; 100PPM; 0.0625W; THICK FILM
48	R25, R29	2	ERJ-2RKF5602	56K	RESISTOR; 0402; 56K OHM; 1%; 100PPM; 0.0625W; THICK FILM
49	R27, R28	2	CRCW04024K70FK;MCR01MZPF4701	4.7K	RESISTOR; 0402; 4.7K OHM; 1%; 100PPM; 0.0625W; THICK FILM
50	R30	1	CRCW0402169KFK	169K	RESISTOR; 0402; 169K OHM; 1%; 100PPM; 0.063W; THICK FILM
51	R35	1	CRCW0402470RFK	470	RESISTOR; 0402; 470 OHM; 1%; 100PPM; 0.0625W; THICK FILM
52	R36, R37	2	CRCW04025K10FK	5.1K	RESISTOR; 0402; 5.1K; 1%; 100PPM; 0.0625W; THICK FILM
53	R38, R42, R55, R57	4	CRCW04022K20FK;RC0402FR-072K2L	2.2K	RESISTOR; 0402; 2.2K OHM; 1%; 100PPM; 0.0625W; THICK FILM
54	R39	1	3296Y-1-503LF	50K	RESISTOR; THROUGH HOLE-RADIAL LEAD; 3296 SERIES; 50K OHM; 10%; 100PPM; 0.5W
55	R43, R47	2	ERJ-2RKF6493	649K	RESISTOR; 0402; 649K OHM; 1%; 100PPM; 0.1W; THICK FILM
56	R46, R64	2	ERJ-2RKF1203	120K	RESISTOR; 0402; 120K OHM; 1%; 100PPM; 0.1W; THICK FILM
57	R48	1	ERJ-2GEJ132	1.3K	RESISTOR; 0402; 1.3K OHM; 5%; 200PPM; 0.1W; THICK FILM
58	R49, R50, R59, R60	4	CRCW0603000020EAHP	0	RESISTOR; 0603; 0 OHM; 0%; JUMPER; 0.25W; THICK FILM
59	R51, R52	2	CRCW04021R00FK	1	RESISTOR; 0402; 1 OHM; 1%; 100PPM; 0.0625W; THICK FILM
60	R53	1	ERJ-2RKF3302	33K	RESISTOR; 0402; 33K OHM; 1%; 100PPM; 0.0625W; THICK FILM
61	R56	1	CRCW040220K0FK	20K	RESISTOR; 0402; 20K OHM; 1%; 100PPM; 0.063W; THICK FILM
62	R61, R63	2	CRCW0402150RFK; 9C04021A1500FL	150	RESISTOR; 0402; 150 OHM; 1%; 100PPM; 0.0625W; THICK FILM
63	R62	1	PNM0402E5000BS	500	RESISTOR; 0402; 500 OHM; 0.1%; 25PPM; 0.05W; THIN FILM
64	R66, R67	2	CRCW0402330KFK	330K	RESISTOR; 0402; 330K OHM; 1%; 100PPM; 0.0625W; THICK FILM
65	R70	1	ERJ-2RKF2203	220K	RESISTOR; 0402; 220K OHM; 1%; 100PPM; 0.1W; THICK FILM
66	R73	1	ERJ-2GEJ474	470K	RES; SMT (0402); 470K; 5%; +/-200PPM/DEGC; 0.1W
67	U1	1	MAX77958EWW+T	MAX77958EWW+T	EVKIT PART - IC; USB TYPE-C AND USB PD CONTROLLER; WLP30; 0.5MM PITCH; PACKAGE OUTLINE: 21-0069; PACKAGE CODE: W302A3+2
68	U2	1	FT2232HL	FT2232HL	IC; MMRY; DUAL HIGH SPEED USB TO MULTIPURPOSE UART/FIFO; LQFP64
69	U3	1	MAX16904RATB50+	MAX16904RATB50+	IC; CONV; 2.1MHZ HIGH-VOLTAGE; 600 MILLIAMPERE MINI-BUCK CONVERTER; TDFN10-EP
70	U4	1	MAX14611ETD+	MAX14611ETD+	IC; TRANS; QUAD BIDIRECTIONAL LOW-VOLTAGE LOGIC LEVEL TRANSLATOR; TDFN14-EP
71	U5, U6	2	MAX8512EXK+	MAX8512EXK	IC; VREG; Ultra-Low-Noise, High PSRR, Adjustable Vout, SC70-5
72	U7	1	MAX77961EFV06+	MAX77961EFV06+	EVKIT PART - IC; CHGR; 24VIN; 6AOUT USB-C BUCK-BOOST CHARGER WITH INTEGRATED FETS FOR 2S/3S LI-ION BATTERIES; PACKAGE CODE: F304A4F+1; PACKAGE OUTLINE: 21-100278; LAND PATTERN: 90-100100; FC2QFN30
73	Y1	1	7M-12.000MAAJ	12MHZ	CRYSTAL; SMT; 18PF; 12MHZ; +/-30PPM; +/-30PPM
74	PCB	1	MAX77958	PCB	PCB:MAX77958
75	R3	0	N/A	OPEN	RESISTOR; 0402; OPEN; FORMFACTOR
76	R72	0	N/A	OPEN	RESISTOR; 0805; OPEN; FORMFACTOR
77	C37, C38, C40-C42	0	N/A	OPEN	CAPACITOR; SMT (1210); OPEN; IPC MAXIMUM LAND PATTERN
TOTAL		222			

# MAX77958 Evaluation Kit with 2S/3S Li+ 6A<sub>OUT</sub> Buck-Boost Charger

Evaluates: MAX77958, MAX77961

## MAX77958-2S/3S EV Kit Schematics

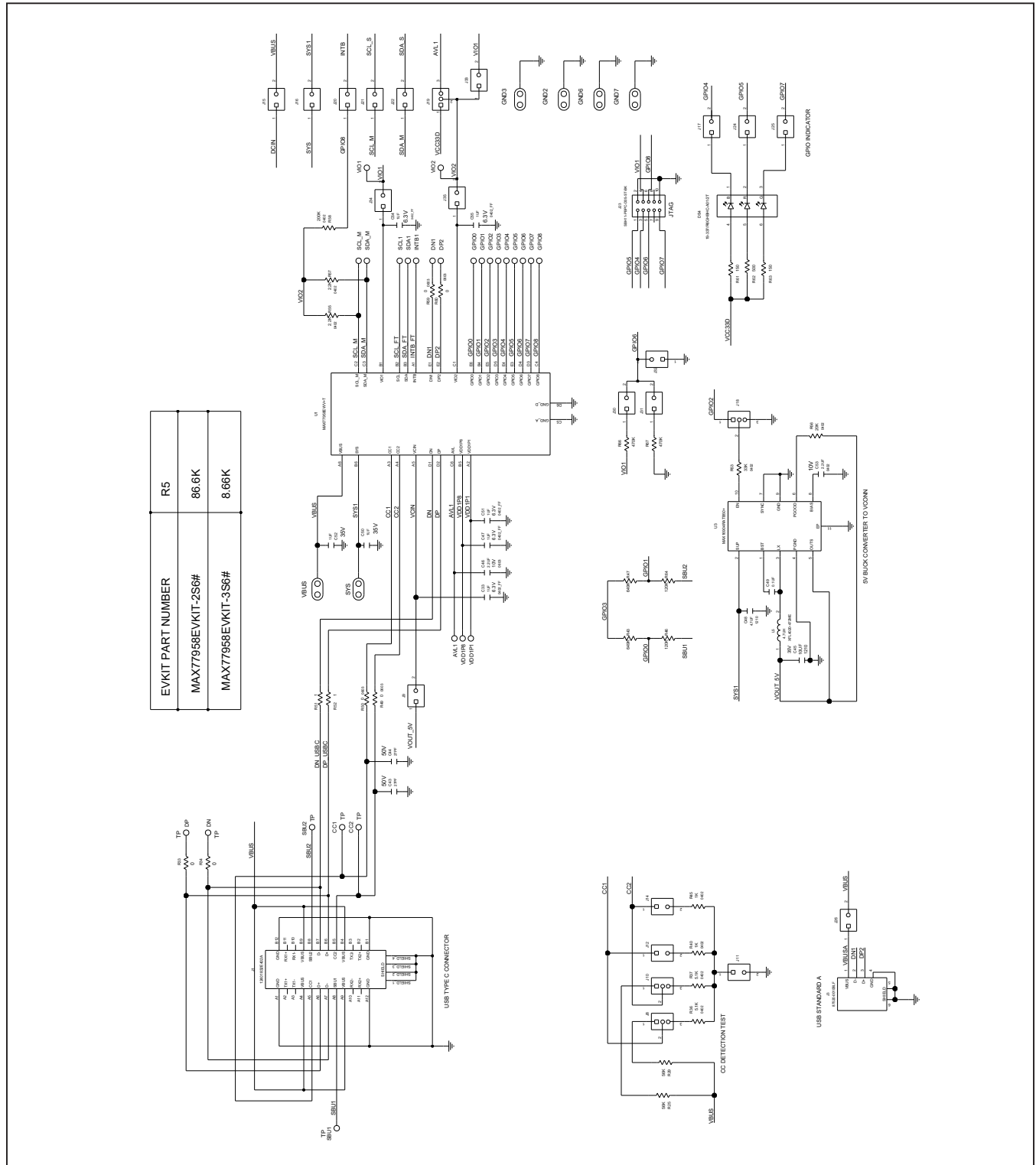





MAX77958-2S/3S EV Kit Schematics (continued)

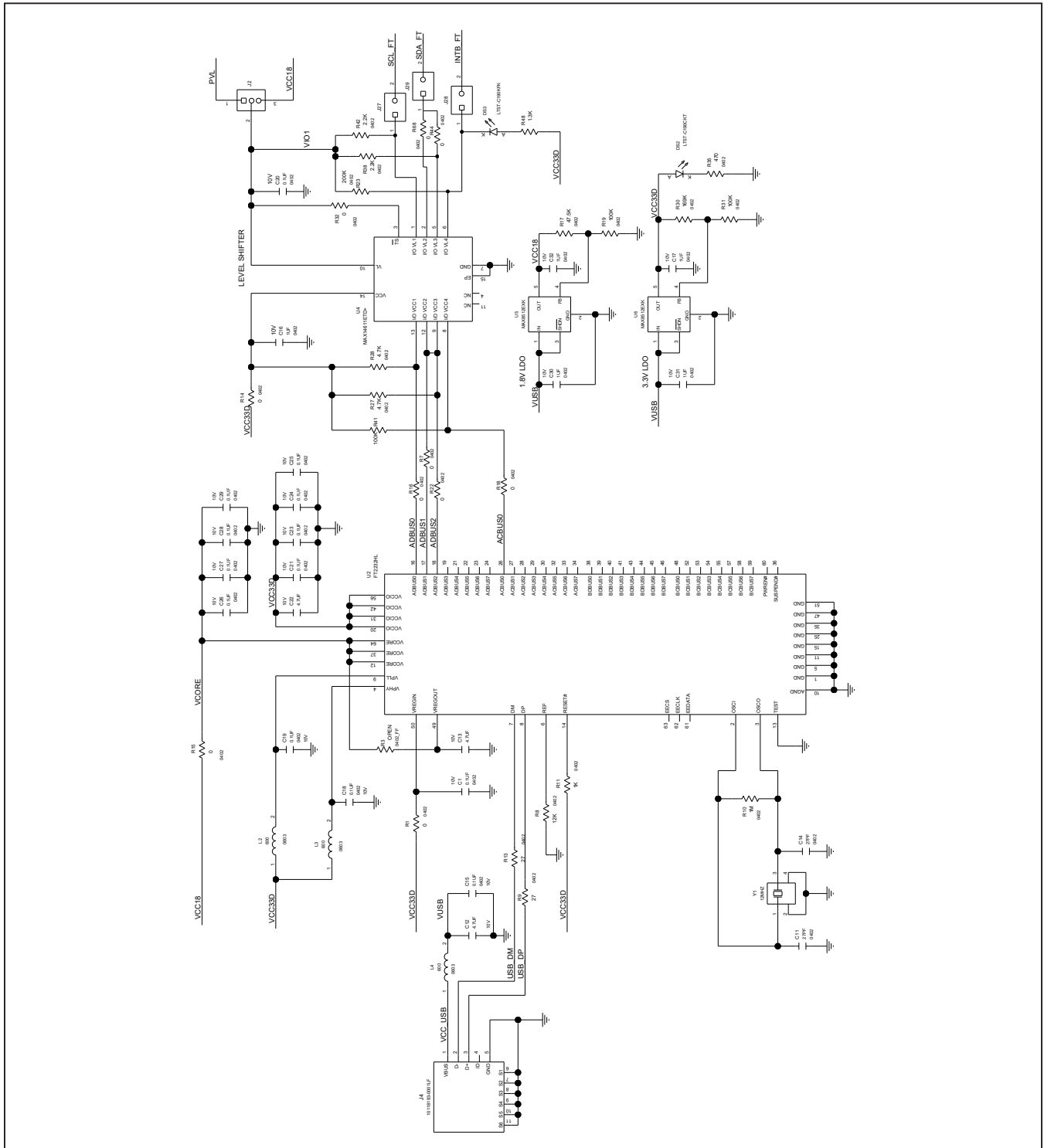

MAXUSB, USB to I<sup>2</sup>C Translator

# MAX77958 Evaluation Kit with 2S/3S Li+ 6A<sub>OUT</sub> Buck-Boost Charger

Evaluates: MAX77958, MAX77961

## MAX77958-2S/3S EV Kit PCB Layouts

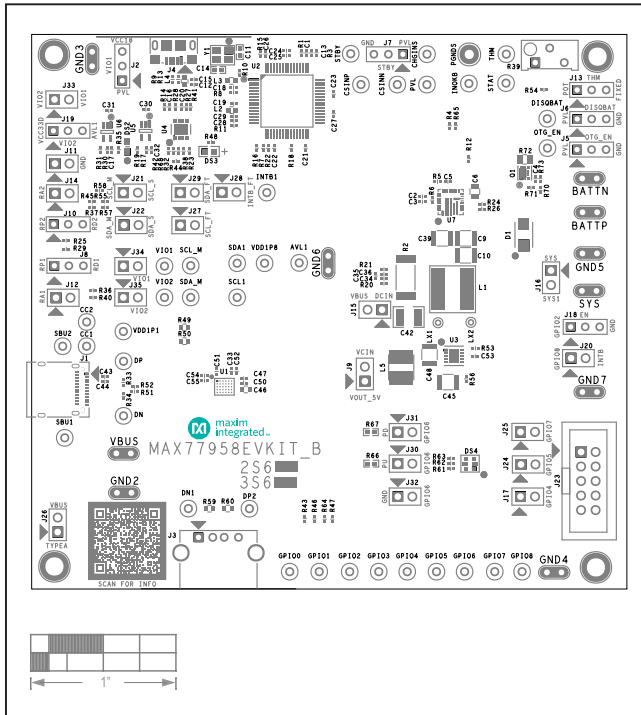

MAX77958-2S/3S EV Kit PCB Layout—Silkscreen Top

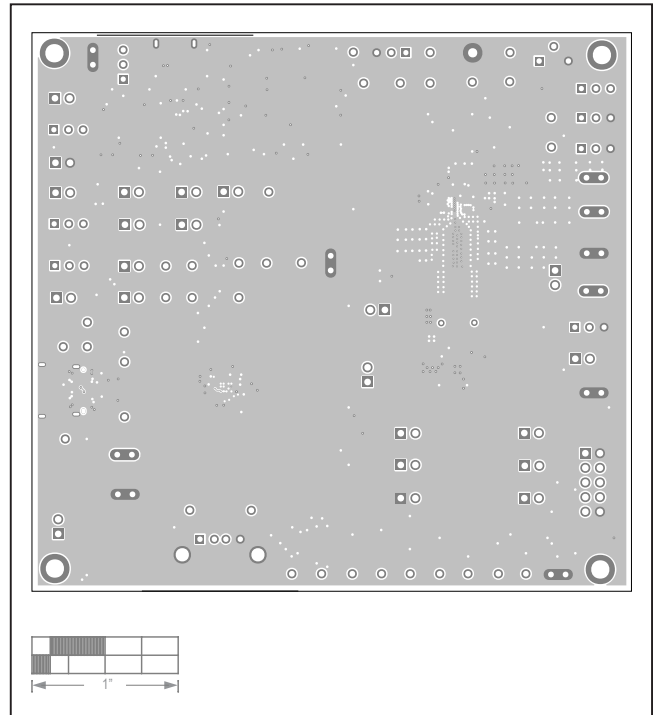

MAX77958-2S/3S EV Kit PCB Layout—Inner Layer 2

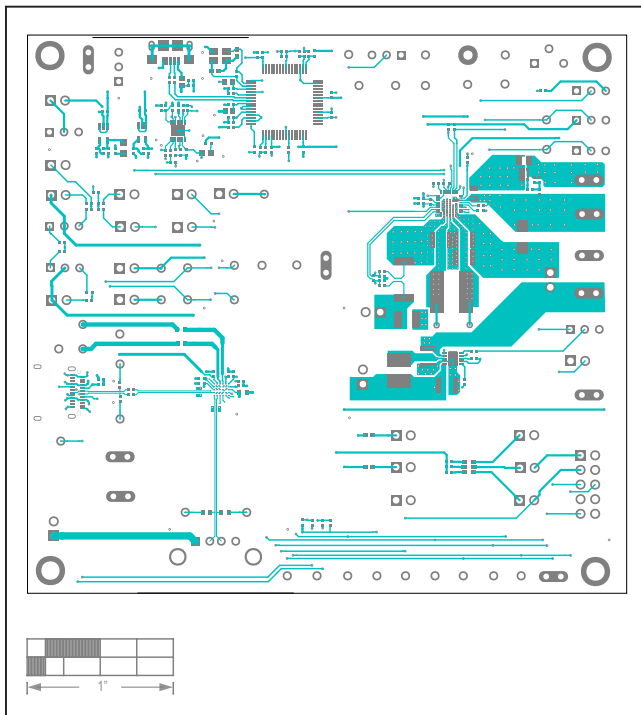

MAX77958-2S/3S EV Kit PCB Layout—Top Layer

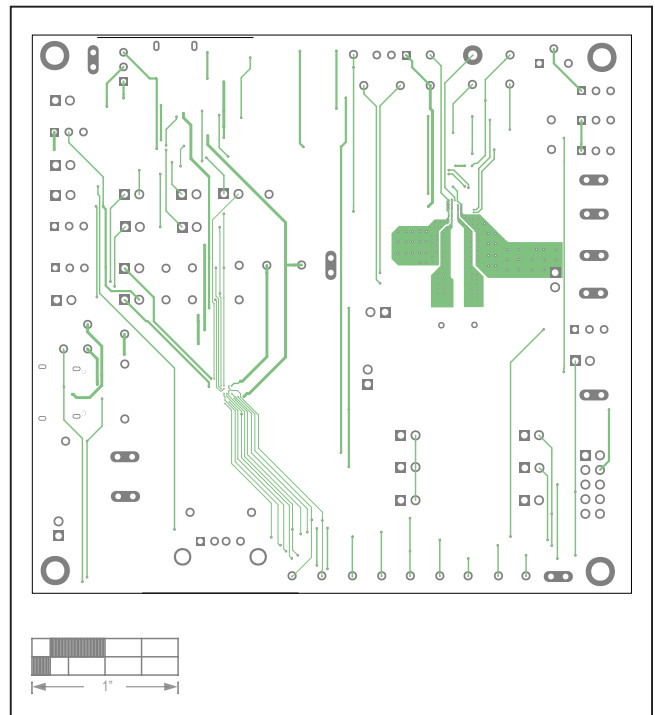

MAX77958-2S/3S EV Kit PCB Layout—Inner Layer 3

MAX77958-2S/3S EV Kit PCB Layouts (continued)

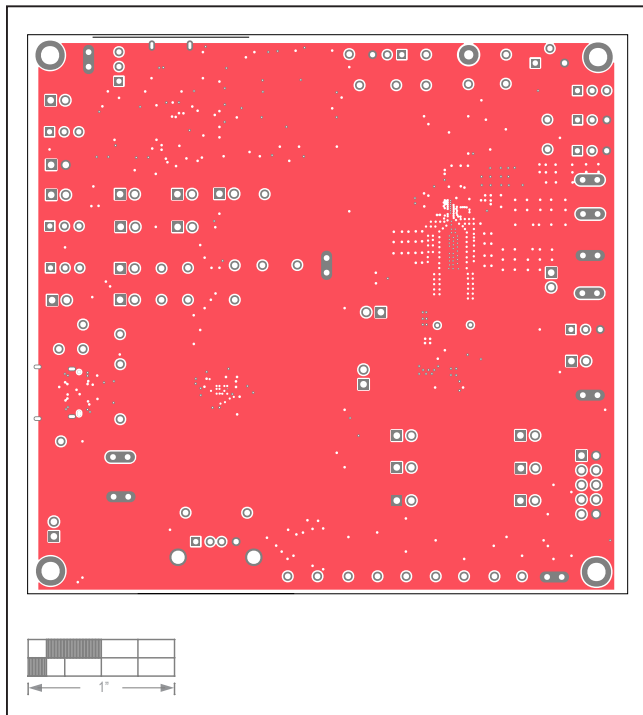

MAX77958-2S/3S EV Kit PCB Layout—Inner Layer 4

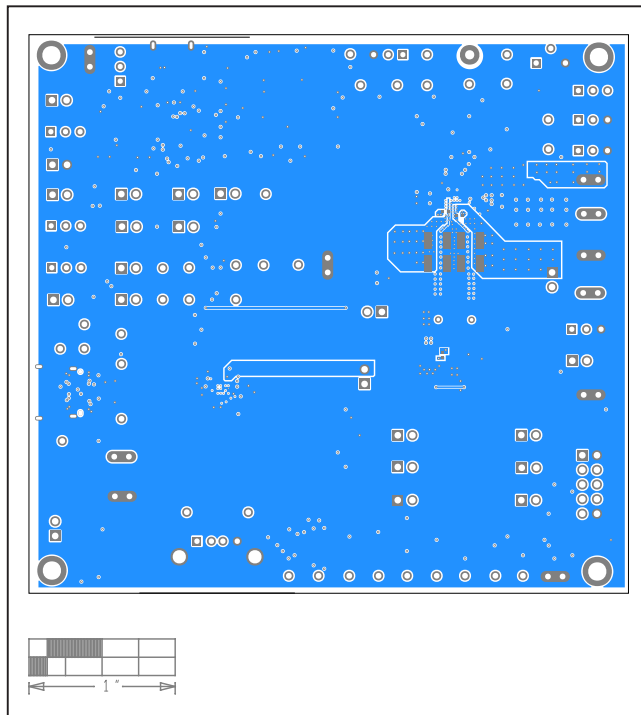

MAX77958-2S/3S EV Kit PCB Layout—Bottom Layer

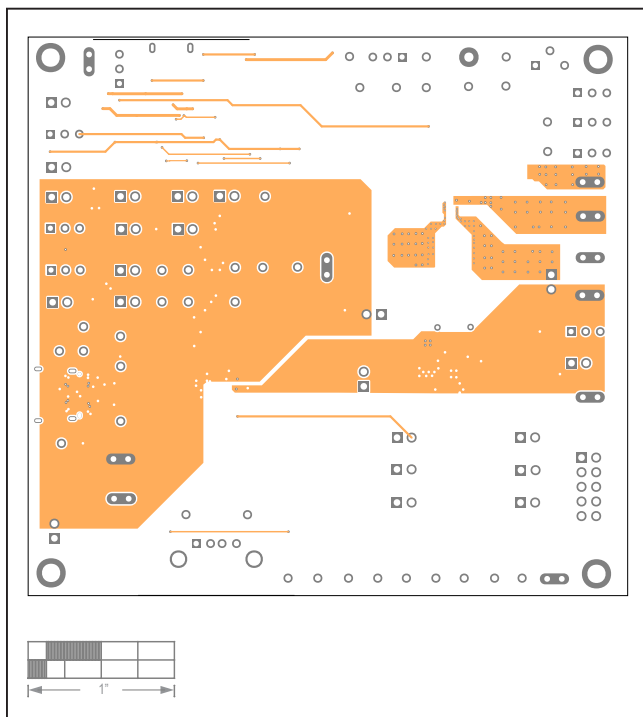

MAX77958-2S/3S EV Kit PCB Layout—Inner Layer 5

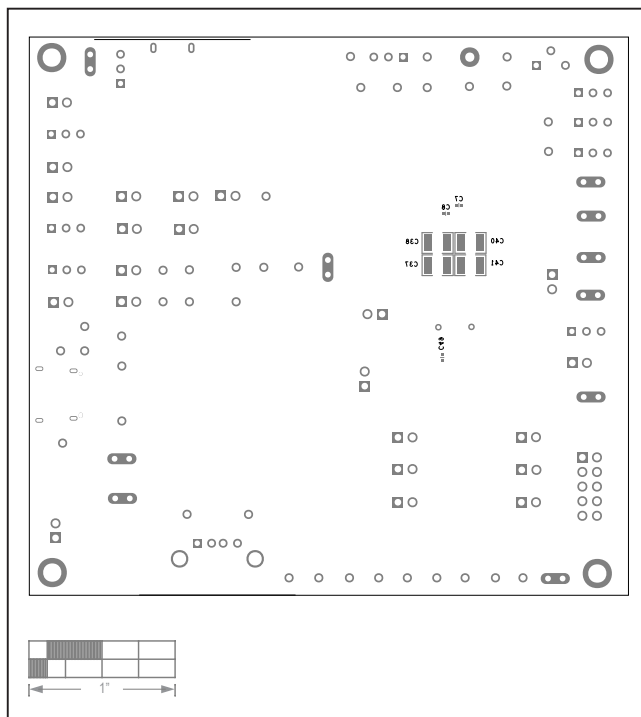

MAX77958-2S/3S EV Kit PCB Layout—Silkscreen Bottom



MAX77958 Evaluation Kit with 2S/3S  
Li+ 6A<sub>OUT</sub> Buck-Boost Charger

Evaluates: MAX77958, MAX77961

## Revision History

REVISION NUMBER	REVISION DATE	DESCRIPTION	PAGES CHANGED
0	1/21	Initial release	—

For pricing, delivery, and ordering information, please visit Maxim Integrated's online storefront at <https://www.maximintegrated.com/en/storefront/storefront.html>.

*Maxim Integrated cannot assume responsibility for use of any circuitry other than circuitry entirely embodied in a Maxim Integrated product. No circuit patent licenses are implied. Maxim Integrated reserves the right to change the circuitry and specifications without notice at any time.*

# Mouser Electronics

Authorized Distributor

Click to View Pricing, Inventory, Delivery & Lifecycle Information:

[Maxim Integrated:](#)

[MAX77958EVKIT-2S6#](#) [MAX77958EVKIT-3S6#](#)