

MAX25610 Evaluation Kit

Evaluates: MAX25610A

General Description

The MAX25610 evaluation kit (EV kit) provides a proven design to evaluate the MAX25610A automotive high-voltage, high-brightness LED (HB LED) controller. The EV kit is set up for buck-boost configurations and operates from a 5V to 18V DC supply voltage. The EV kit is configured to deliver up to 1.1A to one string of LEDs. The total voltage of the string can vary from 3V to 16V. The anode of the LED string should go to the LED+ terminal and the cathode should go to the LEDEXT- terminal.

Benefits and Features

- 5V to 18V Input Voltage Range
- Demonstrates Analog Dimming Control, Digital Dimming Control
- Demonstrates External and Internal Current Sensing
- Demonstrates LED Short and Open Protection
- Proven PCB Layout
- Fully Assembled and Tested

[Ordering Information](#) appears at end of data sheet.

Quick Start

Required Equipment

- MAX25610 EV kit
- 12V, 5A DC power supply
- A series-connected LED string rated for at least 1.5A
- Oscilloscope with a current probe

Procedure

The EV kit is fully assembled and tested. Follow the steps below to verify board operation:

Caution: Do not turn on power supply until all connections are made.

- 1) Verify that all jumpers are in their default positions, as shown in [Table 1](#).
- 2) Connect the positive terminal of the 12V supply to the V_{IN} Board PCB pad and the negative terminal to the GND_{Board} PCB pad.
- 3) Connect the LED string across the LED+ and LEDEXT- PCB pads on the EV kit. The anode of the LED string should go to the LED+ PCB pad and the cathode of the LED string should go to the LEDEXT- PCB pad.
- 4) Clip the current probe on the wire connected to the LED string.
- 5) Turn on the DC power supply.
- 6) Verify that the LEDs illuminate.
- 7) Verify that the oscilloscope displays approximately 1A.

Detailed Description

The MAX25610 evaluation kit (EV kit) provides a proven design to evaluate the MAX25610A automotive high-voltage, high-brightness LED (HB LED) controller. The EV kit is set up for buck-boost configurations and operates from a 5V to 18V DC supply voltage. The EV kit is configured to deliver up to 1.1A to one string of LEDs. The total voltage of the string can vary from 3V to 16V. The anode of the LED string should go to the LED+ terminal and the cathode should go to the LEDEXT- terminal.

Analog Dimming Control (REFI)

When J1 is closed, the LED current is set by external current sensing. The equation to set the LED current is as follows:

$$I_{LED} = \frac{V_{REFI} - 200mV}{6.67 \times R_{LED}}$$

In the case of the EV kit, I_{LED} is set to 1A.

When J1 is open, the LED current is set by internal current sensing. The equation to set the LED current is $I_{LED} = 13125/R_{REFI}$.

PWM Dimming

The EV kit demonstrates the PWM dimming feature of the MAX25610A using either an external PWM signal or a DC voltage at the PWMDIM pin.

Analog-to-PWM dimming:

Keep J2 open and J7 closed as described in [Table 1](#) and remove the 0.1μF C8 capacitor. PWM dimming duty cycle is set by the voltage at PWMDIM between 0.2V (0% duty) and 3V (100% duty). Alternatively, drive the PWMDIM test point with an external DC source. PWMDIM voltages greater than 3V set the dimming duty cycle to 100%.

External PWM dimming:

Keep J2 open and J7 open. Install the 0.1μF C8 capacitor (installed by default). Connect an external PWM signal to the PWMDIM test point. Vary the duty cycle to increase or decrease the intensity of the HB LED string. The PWMDIM input of the device has a 2V (max) rising threshold and a 0.4V (min) falling threshold, and is compatible with 3.3V and 5V logic-level signals.

Table 1. MAX25610 EV Kit Jumper Descriptions

JUMPER	SHUNT POSITION	DESCRIPTION
J1	Closed*	For external current sense. The voltage on the REFI pin is adjusted from 0.2V to 1.2V to set the LED current as follows: $I_{LED} = (V_{REFI} - 0.2)/6.67 \times R_{LED}$
	Open	For internal current sense. The potentiometer R23 is adjusted for setting the LED current as follows: $I_{LED} = 13125/R_{REFI}$
J2	1–2	Connects PWMDIM pin to GND and no switching
	2–3*	Connects PWMDIM pin to V_{EE} (Internal 5V) for 100% duty
J4	Open	Connect an external clock source to perform PWM dimming with J7 open. With J7 closed, the potentiometer R34 is adjusted to set the DC voltage on the PWMDIM pin to perform analog PWM dimming. The capacitor C8 must be removed to perform analog PWM dimming. See the IC datasheet for PWM frequency setting.
	1–2*	External current sense
	2–3	Internal current sense
J7	Open*	For external PWM dimming
	Closed	For analog PWM dimming

Current Sensing

External current sensing:

Keep J1 closed and J4 closed in the 1–2 position, as described in [Table 1](#), and adjust the potentiometer R23 to set the LED current.

Internal current sensing:

Keep J1 open and J4 closed in the 2–3 position, as described in [Table 1](#), and adjust the potentiometer R23 to set the LED current.

Faults

Open and Short LEDs:

When the IC detects the open or short fault conditions of the LEDs, the fault pin is pulled low. The fault pin also goes low when there is an overtemperature condition. The fault pin is an active-low, open-drain output.

Short to Battery:

The EV kit has a latch circuit with a switch for protection when there is a short on the LEDEXT- wire to battery positive voltage.

Ordering Information

PART	TYPE
MAX25610EVKIT#	EV Kit

#Denotes RoHS compliance.

MAX25610 EV Kit Bill of Materials

ITEM	QTY	REF DES	MFG PART #	MANUFACTURER	VALUE	DESCRIPTION
1	5	C2, C12, C14, C20, C21	GRM32ER71H106KA12; CL32B106KBJNNN; UMJ325KB7106KMH; 12105C106K4Z2A	MURATA;SAMSUNG ELECTRONICS;TAIYO YU	10µF	CAPACITOR; SMT (1210); CERAMIC CHIP; 10µF; 50V; TOL = 10%; TG = -55°C TO +125°C; TC = X7R
2	3	C3, C5, C37	GRM188C71E225KE11	MURATA	2.2µF	CAPACITOR; SMT (0603); CERAMIC CHIP; 2.2µF; 25V; TOL = 10%; TG = -55°C TO +125°C; TC = X7S
3	1	C4	885012206071;CGJ3E2X7R1E104K080AA; C1608X7R1E104K080AA;C0603C104K3RAC; GRM188R71E104KA01;C1608X7R1E104K	WURTH ELECTRONICS INC; TDK;TDK;KEMET	0.1µF	CAPACITOR; SMT; 0603; CERAMIC; 0.1µF; 25V; 10%; X7R; -55°C to + 125°C; ±15% from -55°C to +125°C; NOT RECOMMENDED FOR NEW DESIGN USE - 20-000u1-01
4	1	C6	C1608C0G2A102J080AA	TDK	1000PF	CAPACITOR; SMT (0603); CERAMIC CHIP; 1000PF; 100V; TOL = 5%; TG = -55°C TO +125°C; TC = C0G
5	1	C7	C0603C102M3GAC	KEMET	0.001µF	CAPACITOR; SMT (0603); CERAMIC CHIP; 0.001µF; 25V; TOL = 20%; MODEL = C SERIES; TG = -55°C TO +125°C
6	2	C8, C36	C1608X8R1E104K080AA	TDK	0.1µF	CAPACITOR; SMT (0603); CERAMIC CHIP; 0.1µF; 25V; TOL = 10%; TG = -55°C TO +150°C; TC = X8R
7	1	C9	ECH-U1C221JX5	PANASONIC	220PF	CAPACITOR; SMT (0603); CERAMIC CHIP; 220PF; 50V; TOL = 5%; MODEL = PPS; TG = -55°C TO +85°C; TC = ±
8	1	C10	C0603C224K3RAC;GMC10X7R224K25; GRM188R71E224KA88;C1608X7R1E224K080AC	KEMET;MURATA;MURATA;TDK	0.22µF	CAPACITOR; SMT (0603); CERAMIC CHIP; 0.22µF; 25V; TOL = 10%; TG = -55°C TO +125°C; TC = X7R
9	1	C11	C1608X7R1H224K080; GRM188R71H224KAC4	TDK;MURATA	0.22µF	CAPACITOR; SMT (0603); CERAMIC CHIP; 0.22µF; 50V; TOL = 10%; TG = -55°C TO +125°C; TC = X7R
10	2	C13, C19	GRM32ER72A225KA35; CGA6N3X7R2A225K230AB; CC1210KKX7R0BB225;HMK325B7225KM	MURATA;TDK;YAGEO; TAIYO YUDEN	2.2µF	CAPACITOR; SMT (1210); CERAMIC CHIP; 2.2µF; 100V; TOL = 10%; MODEL = GRM SERIES; TG = -55°C to +125°C; TC = X7R
11	1	C17	YFF31AH2A105M	TDK	1µF	EVKIT PART-CAPACITOR; SMT (1206); CERAMIC CHIP; 1µF; 100V; AUTO
12	1	C30	EEH-ZA1H101P	PANASONIC	100µF	CAPACITOR; SMT (CASE_G); ALUMINUM-ELECTROLYTIC; 100µF; 50V; TOL = 20%
13	1	FB1	HF70ACB322513	TDK	52	INDUCTOR; SMT (1210); FERRITE-BEAD; 52; TOL = ±25%; 0.4A; -40°C TO +125°C
14	7	FLTB, OUTOVP, PWMDIM, PWMFRQ, REFI, VCC, VEE	5007	KEystone	N/A	TEST POINT; PIN DIA = 0.125IN; TOTAL LENGTH = 0.35IN; BOARD HOLE = 0.063IN; WHITE; PHOSPHOR BRONZE WIRE SILVER PLATE FINISH; RECOMMENDED FOR BOARD THICKNESS = 0.062IN; NOT FOR COLD TEST
15	8	GND_BB, GND_BOARD, IC_GND, IC_GND_2, LED+, LEDEXT-, VIN_BOARD, VIN_NO_EMI	9020 BUSS	WEICO WIRE	MAXIMPAD	EVK KIT PARTS; MAXIM PAD; WIRE; NATURAL; SOLID; WEICO WIRE; SOFT DRAWN BUS TYPE-S; 20AWG
16	2	J1, J7	PCC02SAAN	SULLINS	PCC02SAAN	CONNECTOR; MALE; THROUGH HOLE; BREAKAWAY; STRAIGHT THROUGH; 2PINS; -65°C TO +125°C
17	2	J2, J4	PCC03SAAN	SULLINS	PCC03SAAN	CONNECTOR; MALE; THROUGH HOLE; BREAKAWAY; STRAIGHT THROUGH; 3PINS; -65°C TO +125°C
18	1	L1	MSS1278T-333ML	COILCRAFT	33µH	INDUCTOR; SMT; FERRITE BOBBIN CORE; 33µH; TOL = ±20%; 3.1A; -40°C TO +125°C
19	1	L2	MSS1278T-472ML	COILCRAFT	4.7µH	INDUCTOR; SMT; FERRITE BOBBIN CORE; 4.7µH; TOL = ±0.2; 6.2A; -40°C TO +125°C
20	4	MH1-MH4	9032	KEystone	9032	MACHINE FABRICATED; ROUND-THRU HOLE SPACER; NO THREAD; M3.5; 5/8IN; NYLON
21	1	Q1	DMN6075S	DIODES INCORPORATED	DMN6075S	TRAN; N-CHANNEL ENHANCEMENT MODE MOSFET; NCH; SOT-23; PD-(0.8W); I-(2A); V-(60V)
22	1	Q4	MMBT2907A	FAIRCHILD SEMICONDUCTOR	MMBT2907A	TRAN; SMALL SIGNAL TRANSISTOR; PNP; SOT-23; PD-(0.35W); IC-(-0.6A); VCEO-(-60V)
23	1	Q5	MMBT2222LT1G	ON SEMICONDUCTOR	MMBT2222LT1G	TRAN; NPN; SOT-23; PD-(0.225W); I-(0.6A); V-(-30V)
24	1	R2	CSR1206FTR130	STACKPOLE ELECTRONICS INC	0.13	RESISTOR; 1206; 0.13 Ω; 1%; 100PPM; 0.5W; THICK FILM

MAX25610 EV Kit Bill of Materials (continued)

26	2	R4, R8	CHPHT0603K1002FGT	VISHAY SFERNICE	10K	RESISTOR; 0603; 10K Ω; 1%; 100PPM; 0.0125W; THICK FILM
27	2	R5, R33	CRCW060351K1FK;ERJ-3EKF5112	VISHAY DALE;PANASONIC	51.1K	RESISTOR; 0603; 51.1K; 1%; 100PPM; 0.10W; THICK FILM
28	1	R6	ERJ-3EKF1782	PANASONIC	17.8K	RESISTOR; 0603; 17.8K Ω; 1%; 100PPM; 0.1W; THICK FILM
29	1	R7	CRCW060360R4FK	VISHAY DALE	60.4	RESISTOR; 0603; 60.4 Ω; 1%; 100PPM; 0.10W; THICK FILM
30	1	R9	CRCW0603100KFK;RC0603FR-07100KL; RC0603FR-13100KL;ERJ-3EKF1003; AC0603FR-07100KL	VISHAY DALE;YAGEO; YAGEO;PANASONIC	100K	RESISTOR; 0603; 100K; 1%; 100PPM; 0.10W; THICK FILM
31	1	R10	CRCW060361K9FK	VISHAY DALE	61.9K	RESISTOR; 0603; 61.9K Ω; 1%; 100PPM; 0.10W; THICK FILM
32	1	R11	TNPW060310K0BE; RN731JTTD1002B	VISHAY DALE;KOA SPEER ELECTRONICS	10K	RESISTOR; 0603; 10K Ω; 0.1%; 25PPM; 0.1W; THICK FILM
33	2	R13, R14	ERJ-3GEYJ102	PANASONIC	1K	RESISTOR; 0603; 1K Ω; 5%; 200PPM; 0.10W; THICK FILM
34	1	R15	ERJ-3GEYJ472	PANASONIC	4.7K	RESISTOR; 0603; 4.7K Ω; 5%; 200PPM; 0.10W; THICK FILM
35	2	R23, R34	3296W-1-104LF	BOURNS	100K	RESISTOR; THROUGH-HOLE-RADIAL LEAD; 100kΩ; 10%; 100PPM; 0.5W; MOLDER CERAMIC OVER METAL FILM
36	1	R24	301-10K-RC	XICON	10K	RESISTOR, 0603, 10K Ω, 5%, 200PPM, 1/16W, THICK FILM
37	1	U1	MAX25610	MAXIM	MAX25610	EVKIT PART - IC; CONV; SYNCHRONOUS BUCK AND BUCK BOOST LED DRIVER/DC-DC CONVERTER; TSSOP16-EP
38	1	PCB	MAX25610	MAXIM	PCB	PCB:MAX25610
TOTAL	72					

DO NOT PURCHASE(DNP)						
ITEM	QTY	REF DES	MFG PART #	MANUFACTURER	VALUE	DESCRIPTION
1	1	C1	GRM188C71E225KE11	MURATA	2.2μF	CAPACITOR; SMT (0603); CERAMIC CHIP; 2.2μF; 25V; TOL = 10%; TG = -55°C TO +125°C; TC = X7S
2	1	C18	C1206C102K5RAC	KEMET	1000PF	CAPACITOR; SMT (1206); CERAMIC CHIP; 1000PF; 50V; TOL = 10%; MODEL = X7R; TG = -55°C TO +125°C; TC = +
3	1	D1	DFLS2100	DIODES INCORPORATED	DFLS2100	DIODE; SCH; SMT (POWERDI-123); PIV = 100V; IF = 2A
4	1	D3	B380-13-F	DIODES INCORPORATED	B380-13-F	DIODE; SCH; SMC; PIV = 80V; IF = 3A
5	1	R1	CSR1206FTR130	STACKPOLE ELECTRONICS INC	0.13	RESISTOR; 1206; 0.13Ω; 1%; 100PPM; 0.5W; THICK FILM
6	1	R25	CRCW12062R00FK	VISHAY DALE	2	RESISTOR, 1206, 2Ω, 1%, 100PPM, 0.25W, THICK FILM
7	1	R38	CRCW06030000Z0	VISHAY DALE	0	RESISTOR; 0603; 0Ω; 0%; JUMPER; 0.1W; THICK FILM
TOTAL	7					

PACKOUT (These are purchased parts but not assembled on PCB and will be shipped with PCB)						
ITEM	QTY	REF DES	MFG PART #	MANUFACTURER	VALUE	DESCRIPTION
TOTAL	0					

MAX25610 EV Kit Schematics

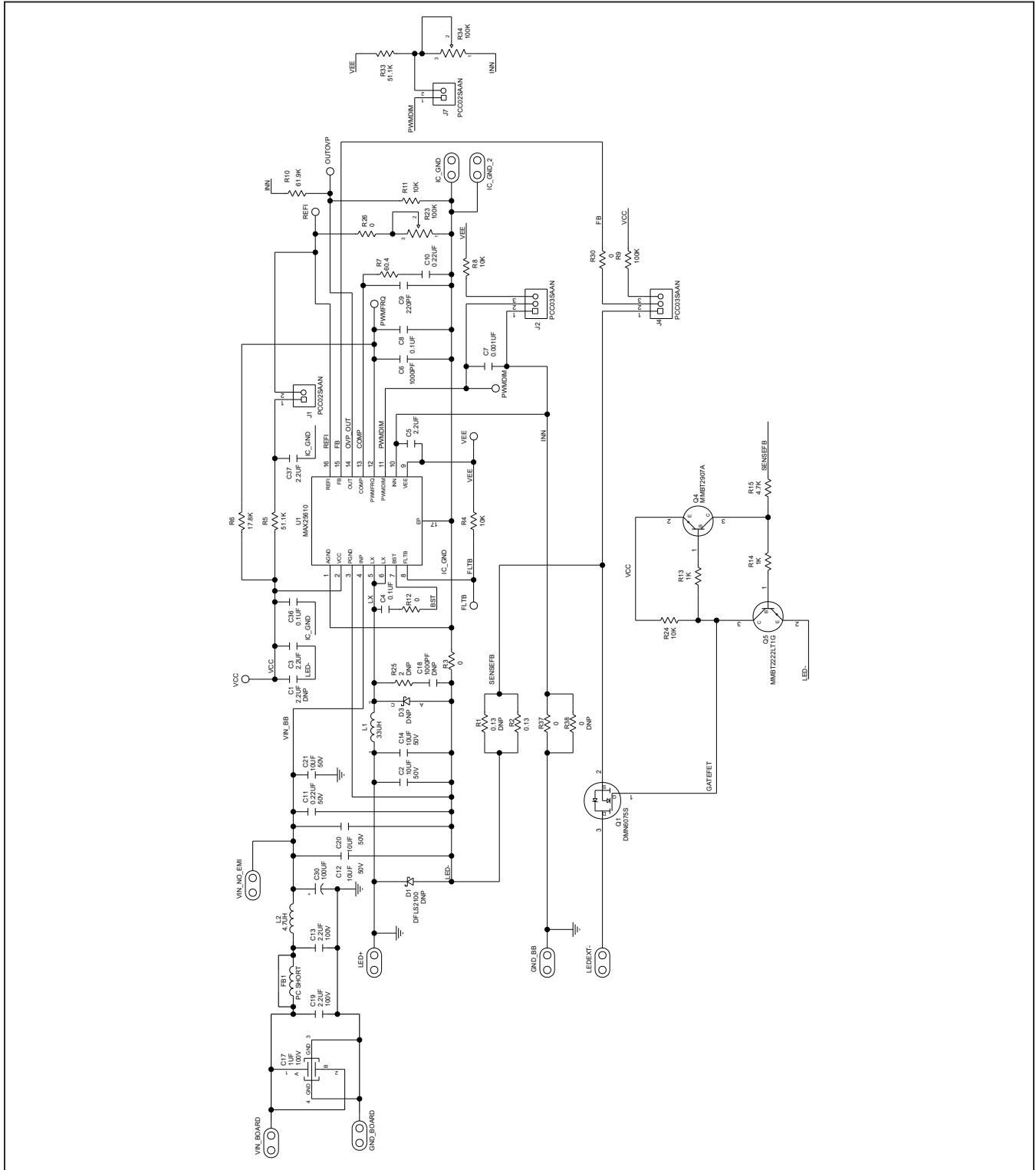

MAX25610 EV Kit PCB Layout Diagrams

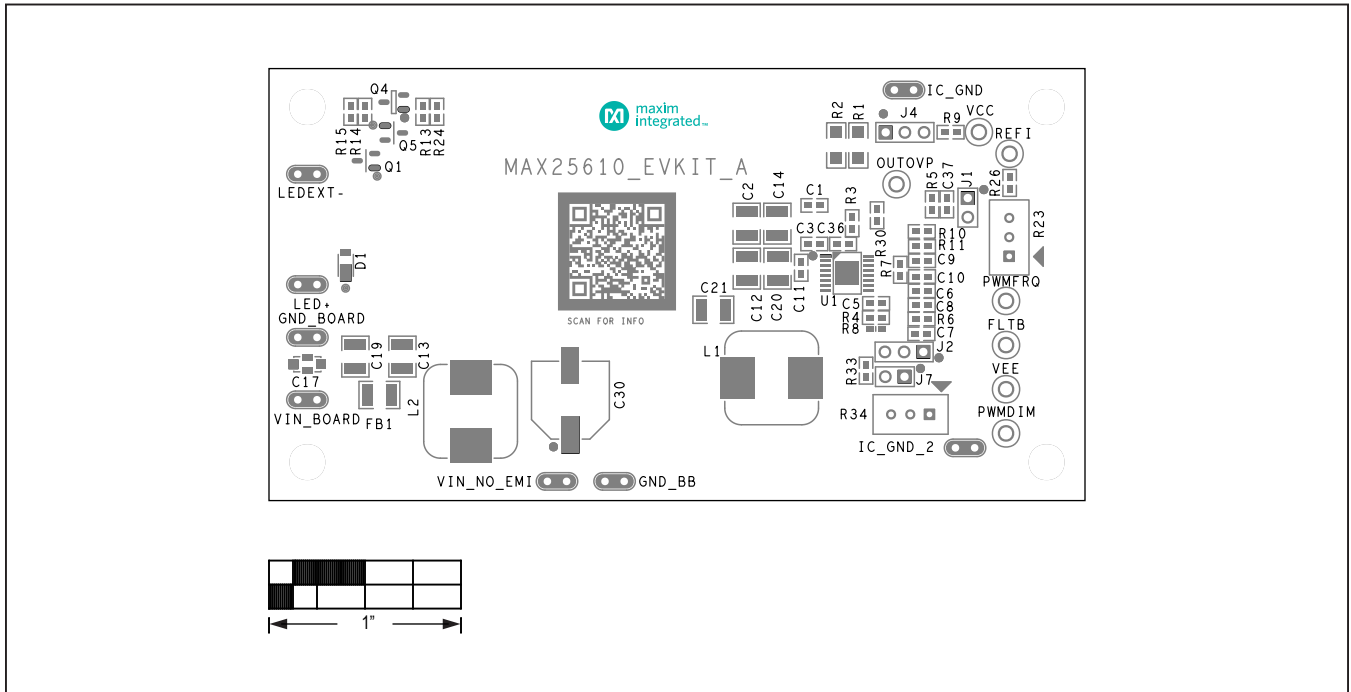

MAX25610 EV Kit Component Placement Guide—Top Silkscreen

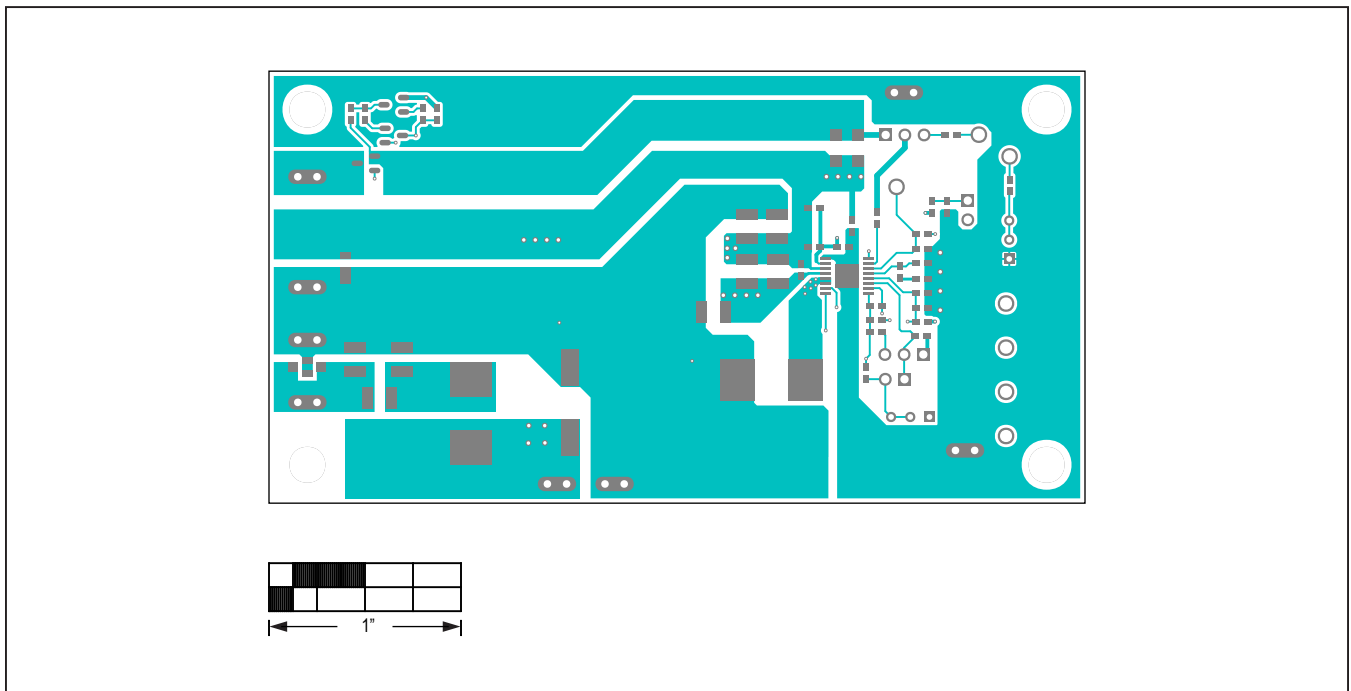

MAX25610 EV Kit PCB Layout—Top View

MAX25610 EV Kit PCB Layout Diagrams (continued)

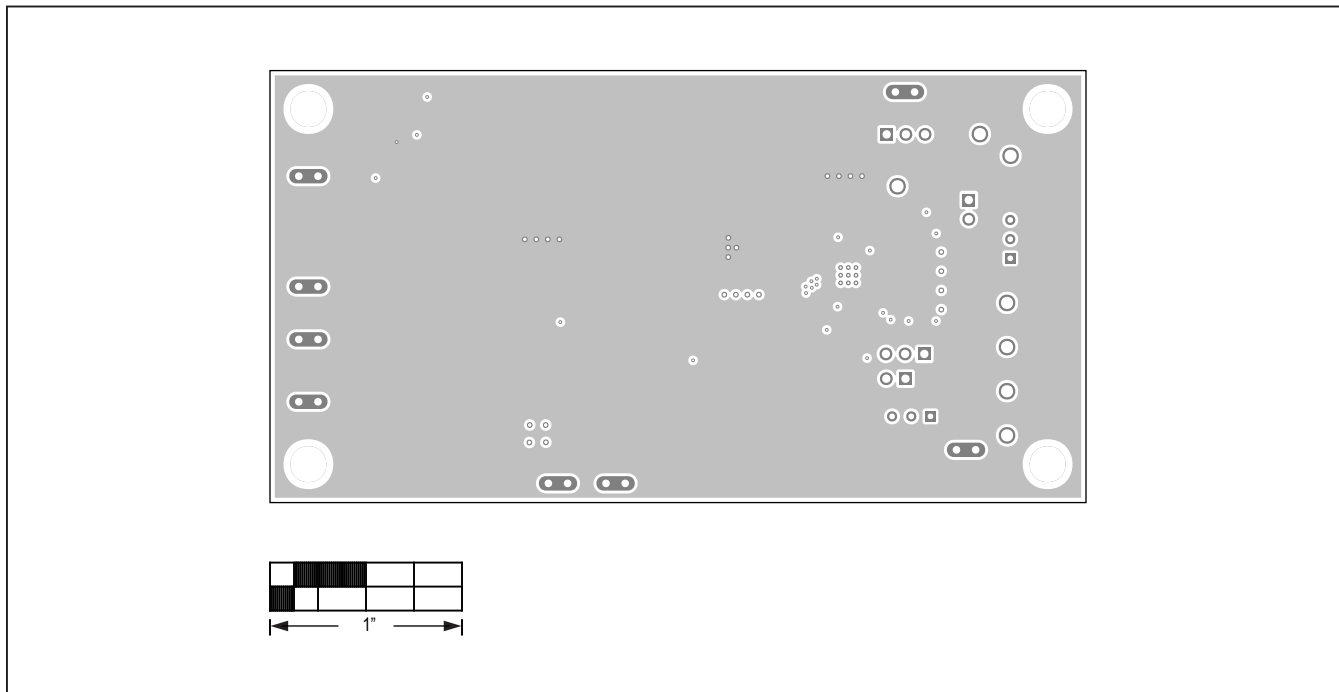

MAX25610 EV Kit PCB Layout—Internal 2

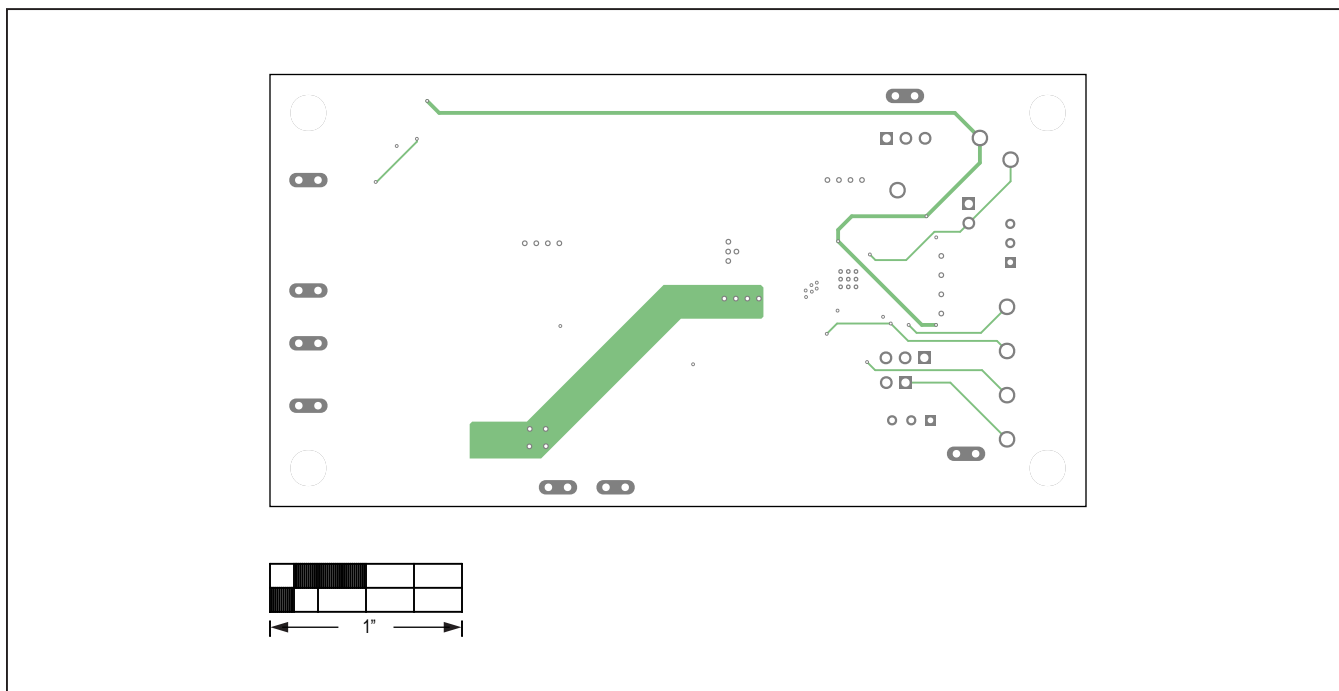

MAX25610 EV Kit PCB Layout—Internal 3

MAX25610 EV Kit PCB Layout Diagrams (continued)

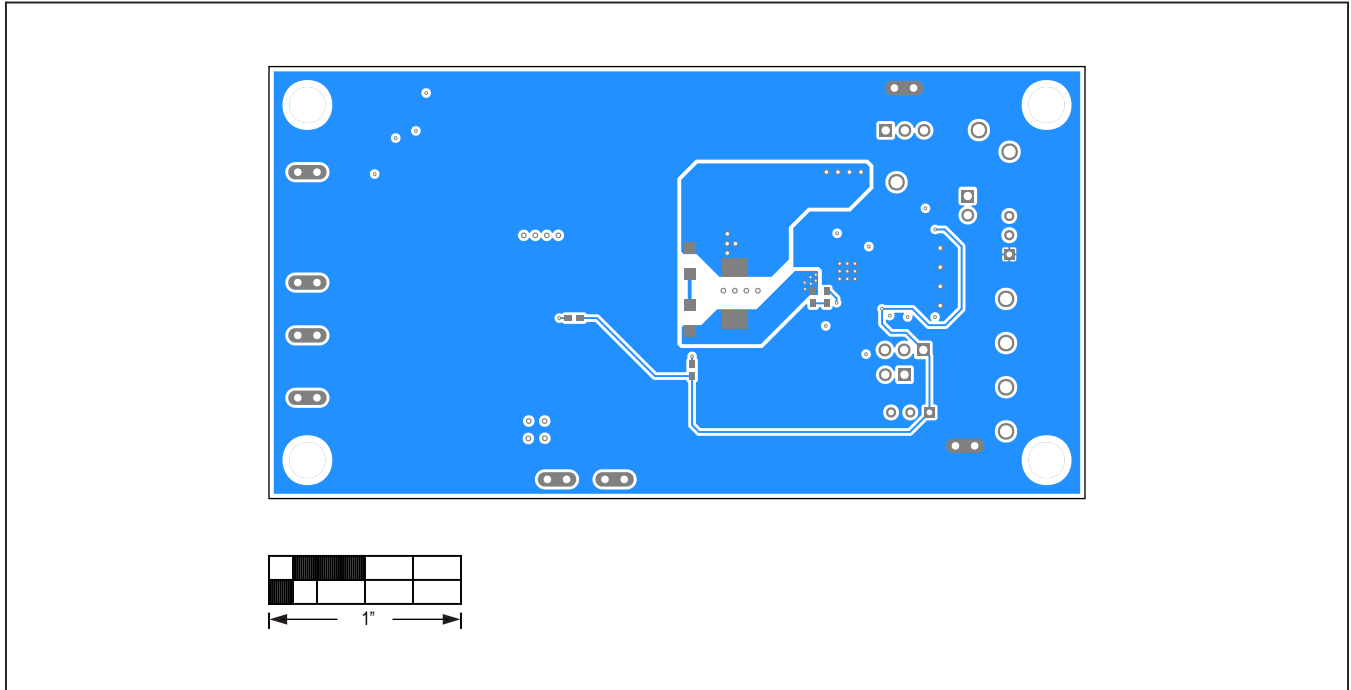

MAX25610 EV Kit PCB Layout—Bottom View

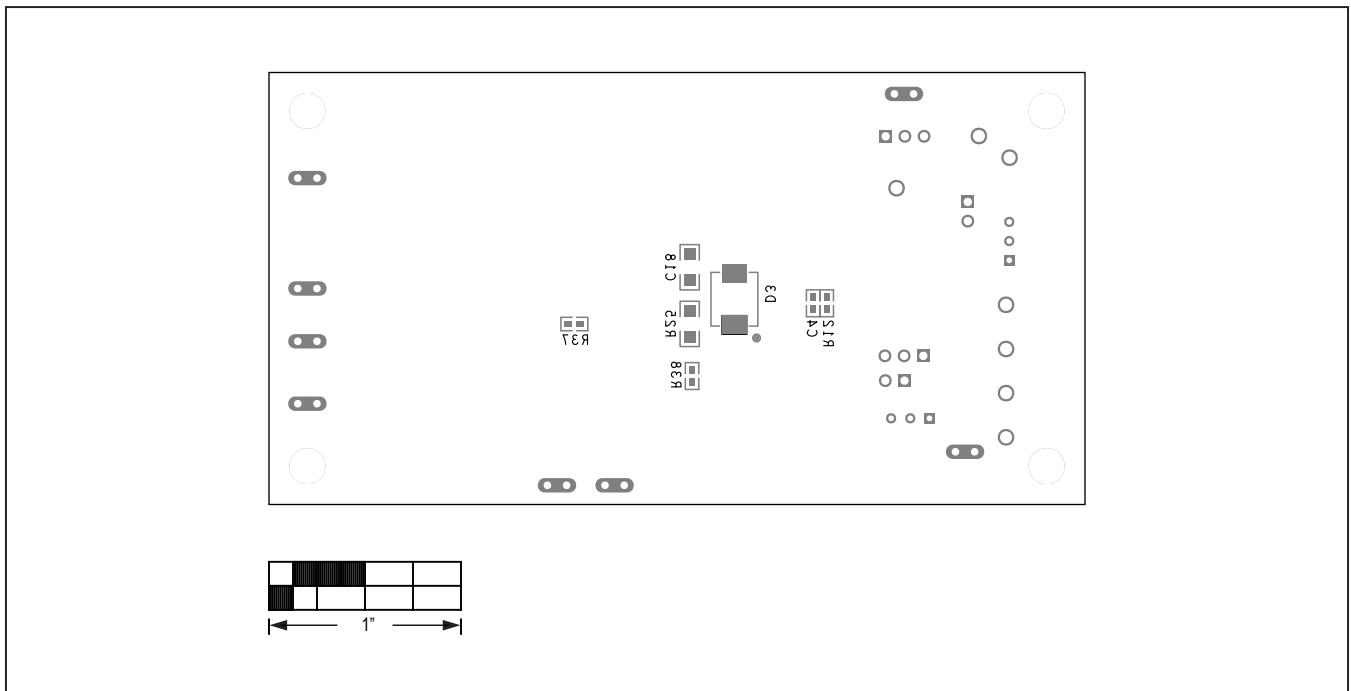

MAX25610 EV Kit Component Placement Guide—Bottom Silkscreen

Revision History

REVISION NUMBER	REVISION DATE	DESCRIPTION	PAGES CHANGED
0	4/19	Initial release	—

For pricing, delivery, and ordering information, please visit Maxim Integrated's online storefront at <https://www.maximintegrated.com/en/storefront/storefront.html>.

Maxim Integrated cannot assume responsibility for use of any circuitry other than circuitry entirely embodied in a Maxim Integrated product. No circuit patent licenses are implied. Maxim Integrated reserves the right to change the circuitry and specifications without notice at any time.

Mouser Electronics

Authorized Distributor

Click to View Pricing, Inventory, Delivery & Lifecycle Information:

[Maxim Integrated:](#)

[MAX25610EVKIT#](#)