

## MAX16984A Evaluation Kit

Evaluates: MAX16984A

### General Description

The MAX16984A evaluation kit (EV kit) demonstrates the MAX16984A automotive high-current, high-efficiency, step-down DC-DC converter with integrated USB Type-A controller. In addition, the device also includes 1GHz bandwidth USB 2.0 D+/D- protection switches which provide ESD and short-to-battery protection for low-voltage transceivers.

The MAX16984A features integrated host-charger port-detection circuitry adhering to the USB 2.0 specification, the USB-IF BC1.2 battery charging specification, Apple iPod/iPhone/iPad® and Samsung® charge-detection termination resistors, and Chinese Telecommunication Industry Standard YD/T 1591-2009.

The MAX16984A integrates high-side current sensing and voltage adjustment circuitry to provide automatic USB voltage adjustment to compensate for voltage drops in captive cables associated with automotive applications.

The MAX16984A step-down, synchronous, DC-DC converter operates from a voltage of up to 28V continuous and protects against load dump transients up to 40V. The converter is programmable for frequencies from 310kHz to 2.2MHz and can deliver 3A continuously.

The EV kit is populated with a MAX16984AATJB/V+ configured for 2.2MHz operation. The data switches of the MAX16984A generally do not require far-eye tuning; the EV kit is populated with shorts.

### Features

- Configurable Charge Detection Modes
  - USB-IF BC1.2 CDP, DCP
  - Apple 2.4A
  - Samsung 2.0A
  - China YD/T 1591-2009 Charging Specification
- Automatic USB Voltage Adjustment by Integrated DC-DC Converter (310kHz - 2.2MHz)
- Proven PCB Layout
- Fully Assembled and Tested

### Quick Start

The following procedure demonstrates the MAX16984A EV kit's high-speed data switches and voltage adjustment capability.

### Required Equipment

- MAX16984A EV kit
- 2m USB-A extension cable (included in EV kit)
- 1.6Ω 20W resistor (included in EV kit) or electronic load
- USB Type-A plug (included in EV kit)
- 14V/2A DC power supply or car battery (VBAT)
- Digital voltmeter (DVM)
- USB Type-A flash drive

**Ordering Information** appears at end of data sheet.

*Apple, iPod, iPhone, and iPad are registered trademarks of Apple Inc.  
Samsung is a registered trademark of Samsung Electronics Co., Ltd.*

### Initial Setup

The MAX16984A EV kit is fully assembled and tested. To setup the MAX16984A board for evaluation, follow these steps:

- 1) Verify SW1 switch is set to HVEN=1, ENBUCK=1, SYNC=0, DATA\_MODE=0.
- 2) Set the VBAT power supply to 14V output, 2A current limit. Turn the output off. Connect negative lead to the GND test loop on EV kit. Connect positive lead to VBAT\_FLT test loop on EV kit.
- 3) Turn the VBAT power supply output on.
- 4) Plug a USB flash drive into the EV kit USB connector (J3).

### High-Speed Data Switches

- 5) Connect the EV kit upstream port (J2) to the computer USB port using the supplied USB-A extension cable.
- 6) Check that the USB flash drive is recognized on your computer and that you can open it. This verifies that the high-speed data switches are operating properly.

Unplug the flash drive and 2m USB-A extension cable from the EV kit.

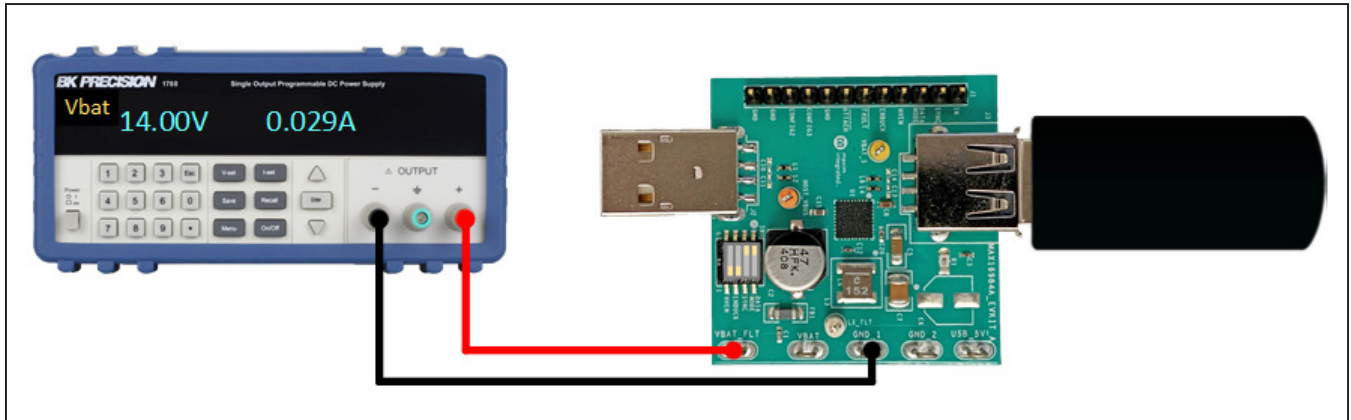

Figure 1: Initial EV Kit Setup

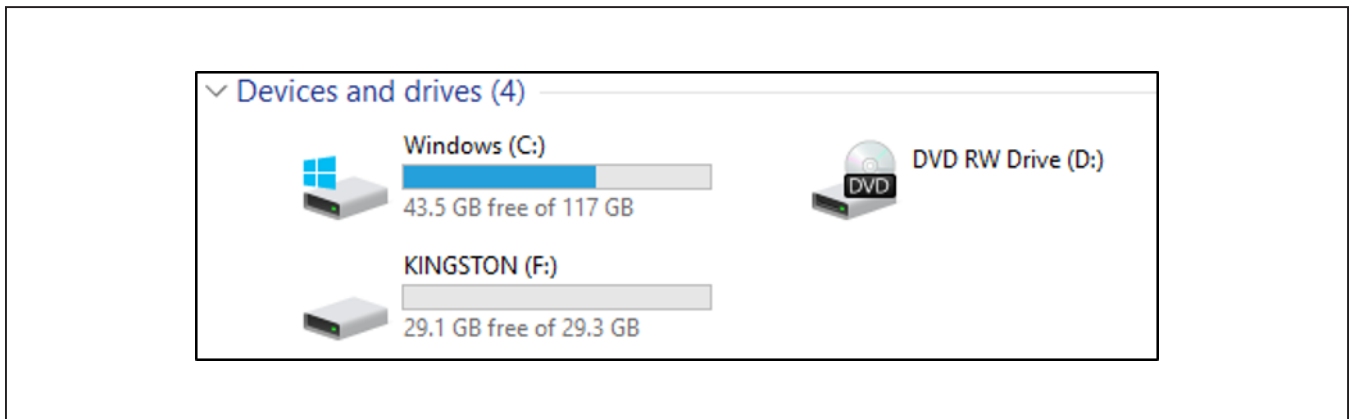

Figure 2: USB Flash Drive Recognized

**Cable Compensation**

- 7) Connect the 2m USB-A extension cable to the MAX16984A EV kit downstream USB connector (J3).
- 8) Connect the Type-A plug to the other end of the extension cable.  
*Note: this is the voltage a portable device will see.*
- 9) Measure the VBUS voltage at the end of the cable. (It should be around 5.15V.)
- 10) Connect the E-load or resistor bank to the USB plug's Ground and VBUS pins.
- 11) The voltage at the far-end of the 2m cable is now  $\approx 5.15V$  regardless of the load current.

**Detailed Description**

The MAX16984A EV kit comes fully assembled, tested, and installed with MAX16984AATJB/V+. The behavior of the EV kit can be adapted by changing the Config Resistors (R2, R3, R4). See [Table 1](#) for the EV kit configuration. Refer to the MAX16984A data sheet for further details on Config Resistors.

**EV Kit Interface**

The header J1 includes input and output test points for controlling the IC and evaluating its functionality. [Table 2](#) lists the individual pins and their functions.

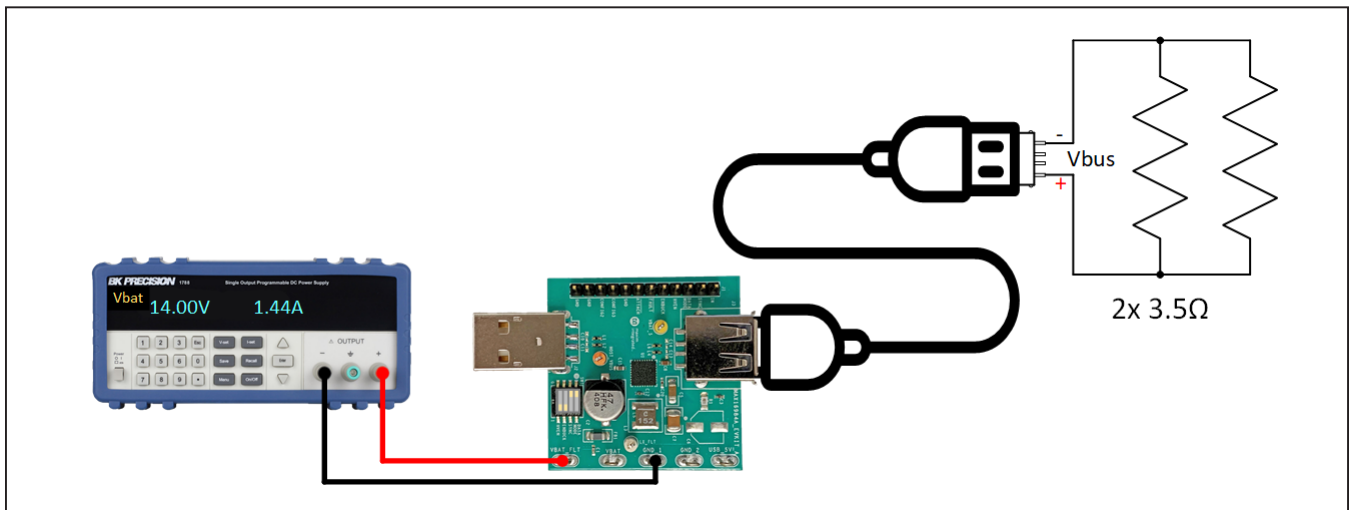

Figure 3: EV Kit Setup for Cable Compensation

**Table 1. Configuration Example**

PIN NAME	RESISTOR	VALUE	DESCRIPTION
CONFIG1	R2	0Ω	Spread Spectrum: ON; Sync as Input; $f_{SW} = 2.2MHz$ <i>Note: If Sync is an Input, tie SYNC to IN or GND if no external clock is used.</i>
CONFIG2	R4	15.4kΩ	GAIN[3:0] = 1100
CONFIG3	R3	3.92kΩ	GAIN[4] = 1; ILIM = 3.04A (min) <i>Note: Gain programmed with this configuration is 28.</i>

The switch SW1 allows the user to set the voltage on the HVEN, ENBUCK, SYNC, and DATA\_MODE pins. Setting a switch to the ON position ties the connected pin high and setting a switch to the OFF position ties the pin to

ground through a 100kΩ pull-down resistor. To externally control these pins through the header J1, set all switches to the OFF position. This leaves the pin connected to the header with a pull-down resistor.

**Table 2. External Header**

J1 PIN	NAME	DESCRIPTION
1	IN	3.3V supply for IN (input/output)
2	SYNC	Buck regulator synchronization pin (input/output)
3	DATA_MODE	Charge detection configuration pin (input)
4	HVEN	IC enable (active-high input)
5	ENBUCK	DC-DC enable (active-high input)
6	FAULTB	Fault indicator (active-low open-drain output)
7	ATTACHB	Attach output (active-low open-drain output)
8	GND	EV kit ground
9	CONFIG3	Config 3 (input)
10	CONFIG2	Config 2 (input)
11	GND	EV kit ground
12	GND	EV kit ground

**Table 3. External Switch**

SW1 PIN	POSITION	DESCRIPTION
HVEN	0	Device disabled
	1	Device enabled
ENBUCK	0	Buck output disabled
	1	Buck output enabled
SYNC	0	<p>SYNC configured as an input: DC-DC operates in forced pulse-width modulation (FPWM).</p> <p>SYNC configured as an output: DC-DC operates in FPWM.</p> <p>SYNC pin generates clock output for synchronization of other devices. If enabled, spread spectrum is also present on SYNC output to reduce electromagnetic interference (EMI) of the device synchronized to MAX16984A. SYNC output is 180° out of phase with internal clock to further help reduce EMI.</p>
	0 with clock applied to SYNC via J1	<p>SYNC configured as an input: DC-DC operates in FPWM.</p> <p>MAX16984A can be synchronized to an external clock - for example, another MAX16984A. Spread spectrum is not applied to external clock from SYNC pin.</p>
	1	<p>SYNC configured as an input: DC-DC operates in skip mode with light/no-load, FPWM otherwise. Refer to MAX16984A data sheet for more information.</p>
DATA_MODE	0	High-Speed pass-through mode (SDP)
	1	Auto-CDP mode

**Basic Functionality**

Connect a battery voltage supply between VBAT\_FLT and GND test loops. The 3.3V IN pin is self-powered on the MAX16984A EV kit by a 3.3V linear regulator (MAX15006A). Setting the HVEN switch to ON pulls the HVEN pin to VBAT and enables the device. The ENBUCK pin is connected to the upstream USB host VBUS and SW and must be high for the DC-DC converter to turn on. The charge mode can be configured by using the DATA\_MODE switch or pin.

**Fault Diagnostics**

The FAULT pin is designed to be software compatible with Maxim Type-A Automotive USB solutions. See the MAX16984A data sheet for all conditions that can trigger a FAULT event.

**IC Efficiency Measurement**

The MAX16984A EV kit provides the ability to measure the efficiency of the MAX16984A buck-converter itself. This method decouples the losses resulting from the output inductor, output capacitor and PCB traces and is accomplished by utilizing two test-points: VBAT\_S and LX\_FLT. By measuring the DC voltages at these test points, the input current and output (load) current, IC efficiency can be calculated:

$$\eta_{IC} = (V_{LX\_FLT} \times I_{OUT}) / (V_{BAT\_S} \times I_{IN})$$

**PCB Layout Guidelines**

A good PCB layout is critical to proper system performance. The loop area of the DC/DC conversion circuitry must be minimized as much as possible. Place the input capacitor, power inductor, and output capacitor very close to the IC. Shorter traces should be prioritized over wider traces.

A low-impedance ground connection between the input and output capacitors is necessary (route through the ground pour on the exposed pad). Connect the exposed pad to ground. Place multiple vias in the pad to connect to all other ground layers for proper heat dissipation. (Failure to do this can result in the IC repeatedly reaching thermal shutdown.) Use a single common ground with GND vias directly adjacent to all components that via down to an adjacent ground plane. High-frequency return currents flow directly under their corresponding traces.

USB traces must be routed as a 90Ω differential pair with an appropriate keep-out area. Avoid routing USB traces near high-frequency switching nodes or other sources of noise such as clocks. The length of the routing should be minimized and avoid 90 degree turns, excessive vias, and RF stubs. MAX16984A EV kit has high-bandwidth data switches, see the IC data sheet for details on tuning recommendations.

**Ordering Information**

PART	TYPE
MAX16984AEVKIT#	EV Kit

#Denotes RoHS compliance.

MAX16984A EV Kit Bill of Materials

QTY	REFERENCE	DESCRIPTION	MANUFACTURER	PART NUMBER
1	C1	CERAMIC CAPACITOR (0402) 2200pF 50V 10% X7R	TDK	C1005X7R1H222K050BA
1	C2	ALUMINUM-ELECTROLYTIC CAPACITOR 47UF 50V 20% -55C TO 105C	PANASONIC	EEE-FK1H470P
6	C3, C4, C12, C16, C18, C20	CERAMIC CAPACITOR (0402) 0.1uF 50V 10% X7R	TDK	CGA2B3X7R1H104K050BE
1	C5	CERAMIC CAPACITOR (1206) 10UF 50V 10% X7R	TDK	CGA5L1X7R1H106K160AC
1	C6	DNP		
1	C7	CERAMIC CAPACITOR (1210) 22UF 25V 10% X7R	MURATA	GRM32ER71E226KE15
2	C8, C17	CERAMIC CAPACITOR (0603) 2.2uF 16V 10% X7R	MURATA	GRM188Z71C225KE43
5	C9-C11, C13, C14	DNP		
1	C15	CERAMIC CAPACITOR (0603) 1uF 16V 10% X7R	TDK	CGA3E1X7R1C105K080AC
1	D1	SCHOTTKY BARRIER DIODE (SMB) 60V 3A -55C TO 125C	DIODES INCORPORATED	B360B-13-F
1	D2	SCHOTTKY BARRIER DIODE (SOD-323) 30V 0.5A	DIODES INCORPORATED	B0530WS-7-F
1	FB1	FERRITE-BEAD (1206) 600R 25% 2.9A	MURATA	BLM31KN601SH1
5	GND_1, GND_2, USB_5V, VBAT, VBAT_FLT	TEST POINT	KEYSTONE	5020
1	HOST_VBUS	ORANGE TEST POINT	KEYSTONE	5003
1	J1	HEADER 12-PINS	SAMTEC	TSW-112-07-G-S
1	J2	USB TYPE-A PLUG	TE CONNECTIVITY	1734028-1
1	J3	USB TYPE-A RECEPTACLE	ASSMANN	AU-Y1006-R
6	L1, L2, L4, L6, R2, R7	RESISTOR (0402) 0R 0.2W	VISHAY DALE	CRCW04020000Z0EDHP
1	L3	DNP		
1	L5	INDUCTOR 1.5UH 20% 8.1A	COILCRAFT	XEL4030-152ME
1	LX_FLT	WHITE TEST POINT	KEYSTONE	5002
1	R1	RESISTOR (0805) 0.033R 1% +/-50PPM/C 0.5W	SUSUMU CO LTD.	KRL1220E-M-R033-F
1	R3	RESISTOR (0402) 3.92K 1% 0.063W	VISHAY DALE	CRCW04023K92FK
1	R4	RESISTOR (0402) 15.4K 1% 0.1W	PANASONIC	ERJ-2RKF1542
2	R8, R17	RESISTOR (0402) 10K 1% 0.063W	VISHAY DALE	CRCW040210K0FK
6	R9-R14	RESISTOR (0402) 100K 5% 0.063W	VISHAY DALE	CRCW0402100KJN
2	R15, R16	DNP		
1	SW1	QUAD SPST HALF-PITCH DIP SWITCH	C&K COMPONENTS	TDA04H0SB1
1	U1	MAX16984AATJB/V+	MAXIM	MAX16984AATJB/V+
1	U2	ULTRA-LOW QUIESCENT-CURRENT LINEAR REGULATOR	MAXIM	MAX15006AATT+
1	VBAT_S	YELLOW TEST POINT	KEYSTONE	5004
1	PCB	MAX16984A revA	MAXIM	MAX16984A
1	PACK-OUT	2m USB-A Extension Cable	Qualtek	3021057-02M
1	PACK-OUT	USB-A Plug	Kycon	KUSBX-SMT2AP5S-B
2	PACK-OUT	3.5R 10W 1% Resistor	Vishay Dale	RS0103R500FE12

MAX16984A EV Kit Schematic

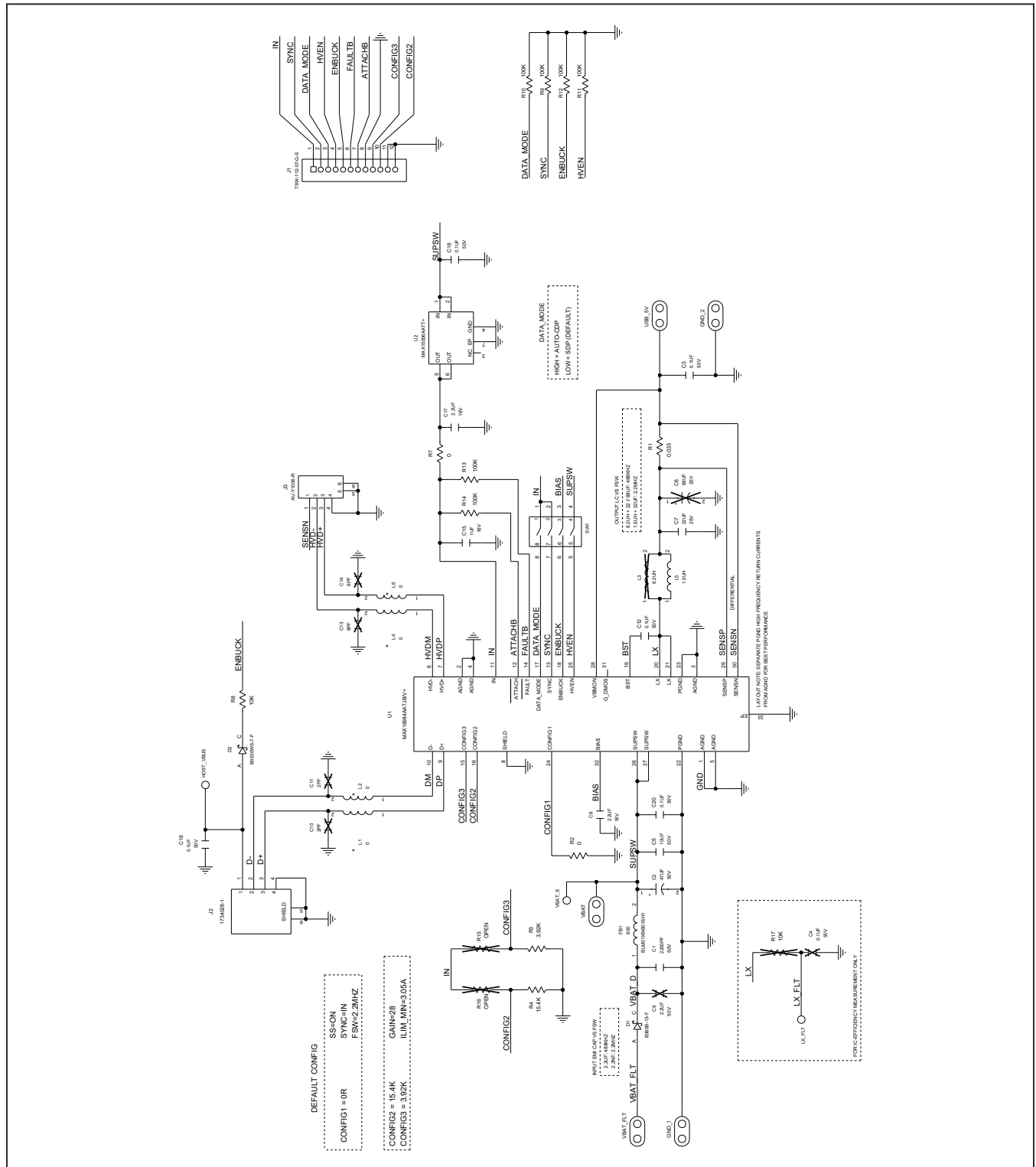

MAX16984A EV Kit PCB Layout Diagrams

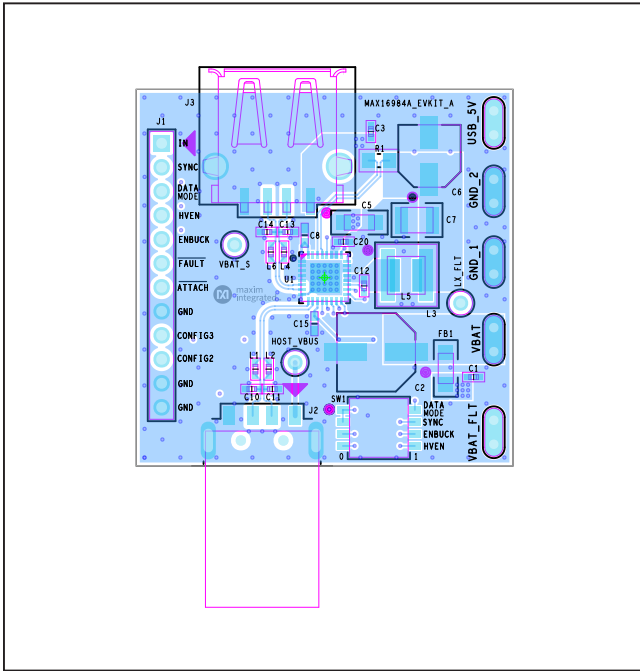

MAX16984A EV Kit PCB Layout—Top View

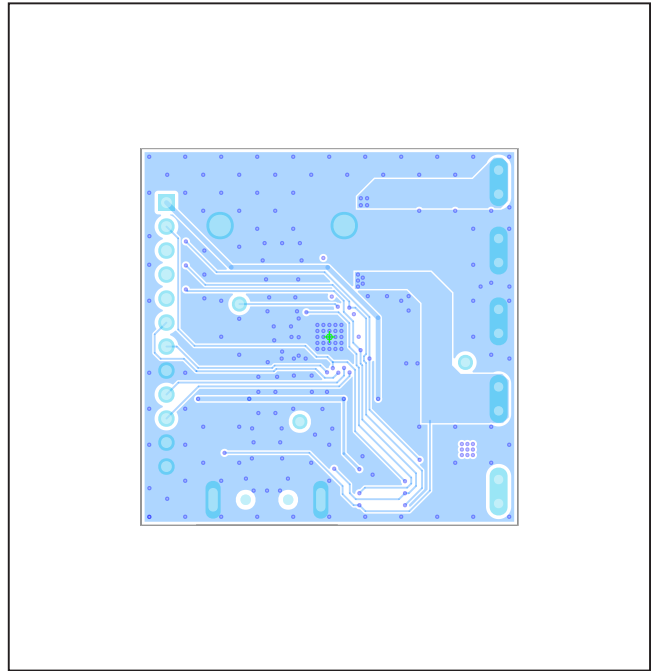

MAX16984A EV Kit PCB Layout—Layer 3

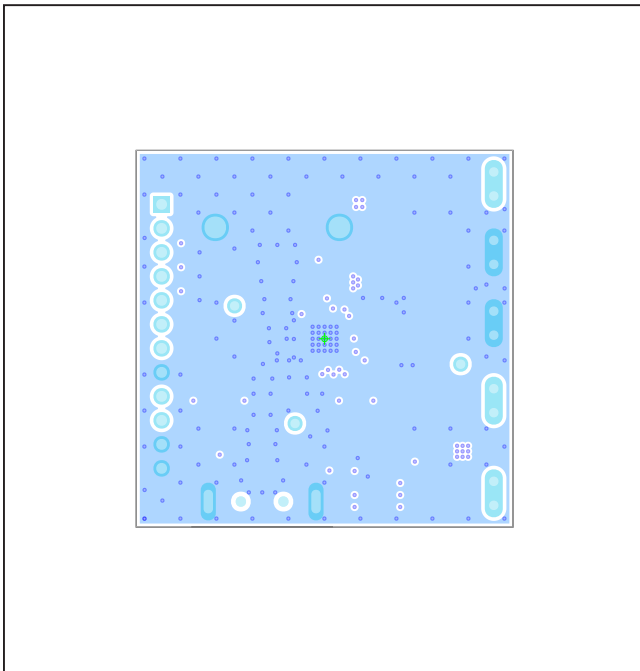

MAX16984A EV Kit PCB Layout—Layer 2

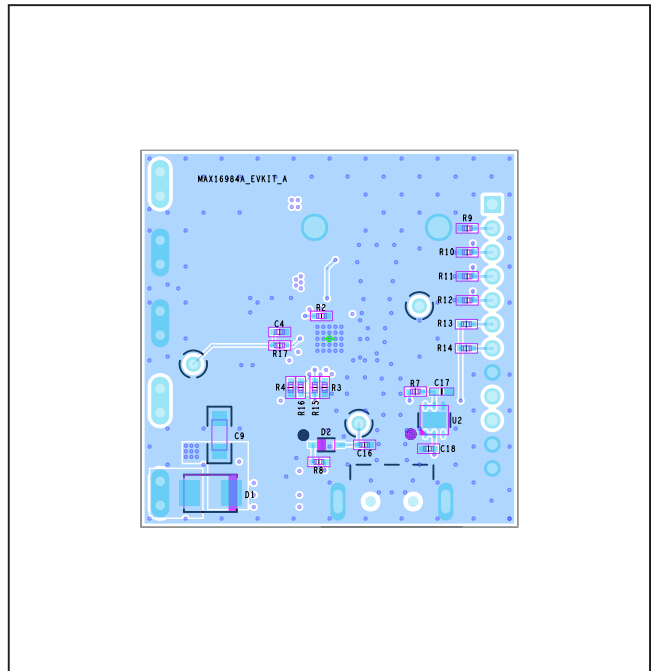

MAX16984A EV Kit PCB Layout—Bottom View



## Revision History

REVISION NUMBER	REVISION DATE	DESCRIPTION	PAGES CHANGED
0	4/20	Initial release	—
1	12/20	Update for SYNC pin logic change	4

For pricing, delivery, and ordering information, please visit Maxim Integrated's online storefront at <https://www.maximintegrated.com/en/storefront/storefront.html>.

*Maxim Integrated cannot assume responsibility for use of any circuitry other than circuitry entirely embodied in a Maxim Integrated product. No circuit patent licenses are implied. Maxim Integrated reserves the right to change the circuitry and specifications without notice at any time.*

# Mouser Electronics

Authorized Distributor

Click to View Pricing, Inventory, Delivery & Lifecycle Information:

[Maxim Integrated:](#)

[MAX16984AEVKIT#](#)