

GaAs pHEMT MMIC POWER AMPLIFIER, 0.2 - 22 GHz

Typical Applications

The HMC907A is ideal for:

- Test Instrumentation
- Military & Space

Features

- High P1dB Output Power: +28 dBm
- High Gain: 14 dB
- High Output IP3: +41 dBm
- Single Supply: +10V @ 350 mA
- 50 Ohm Matched Input/Output
- Die Size: 2.92 x 1.35 x 0.1 mm

Functional Diagram

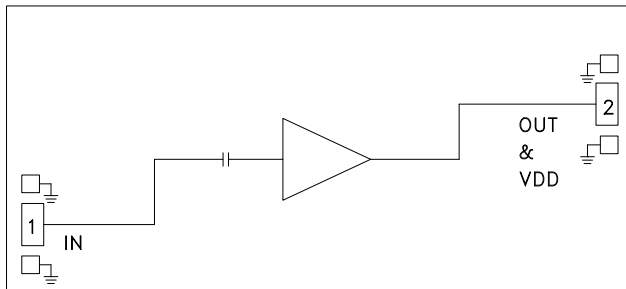

General Description

The HMC907A is a GaAs MMIC pHEMT Distributed Power Amplifier die which operates between 0.2 and 22 GHz. This self-biased power amplifier provides 14 dB of gain, 41 dBm output IP3 and +28 dBm of output power at 1 dB gain compression while requiring only 350mA from a +10V supply. Gain flatness is excellent at ± 0.7 dB from DC to 12 GHz making the HMC907A ideal for EW, ECM, Radar and test equipment applications. The HMC907A amplifier I/Os are internally matched to 50 Ohms facilitating integration into Multi-Chip-Modules (MCMs). All data is taken with the chip connected via two 0.025mm (1 mil) wire bonds of minimal 0.31 mm (12 mils) length.

Electrical Specifications, $T_A = +25^\circ\text{C}$, $V_{dd} = +10\text{V}$, $I_{dd} = 350\text{mA}$

Parameter	Min.	Typ.	Max.	Min.	Typ.	Max.	Min.	Typ.	Max.	Units
Frequency Range		0.2 - 8		8 - 16			16 - 22			GHz
Gain	12	13.5		12	13.5		12.5	14		dB
Gain Flatness		± 0.7			± 0.6			± 0.3		dB
Gain Variation Over Temperature		0.005			0.004			0.007		dB/°C
Input Return Loss		14			15			15		dB
Output Return Loss		13			16			16		dB
Output Power for 1 dB Compression (P1dB)	25	28		25.5	28.5		25	28		dBm
Saturated Output Power (Psat)		30			30			29		dBm
Output Third Order Intercept (IP3) Pout / tone = +16dBm		40			41			41		dBm
Output Second Order Intercept (IP2) Pout / tone = +16dBm		41			41			42		dBm
Noise Figure		6			3			4		dB
Supply Current (Idd) (Vdd= 10V)		350			350			350		mA
Supply Voltage	8	10	11	8	10	11	8	10	11	V

**GaAs pHEMT MMIC
POWER AMPLIFIER, 0.2 - 22 GHz**

Gain & Return Loss

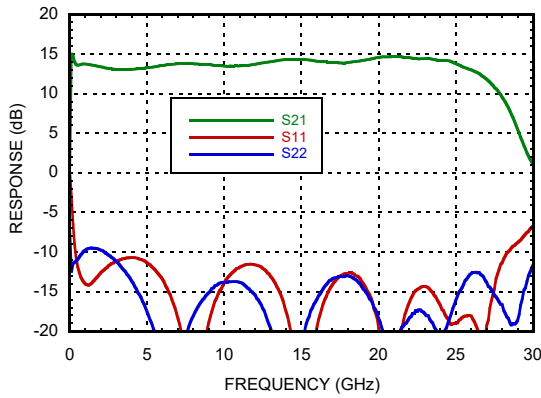

Low Frequency Gain & Return Loss

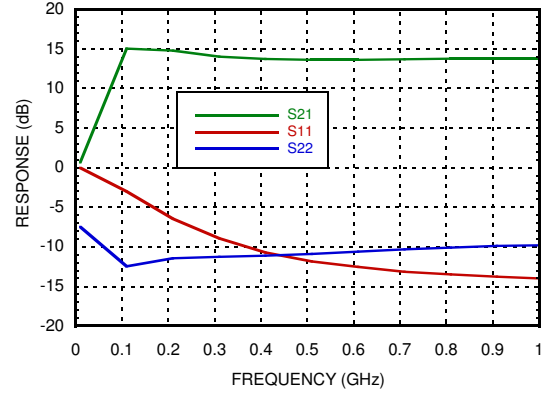

Gain vs. Temperature

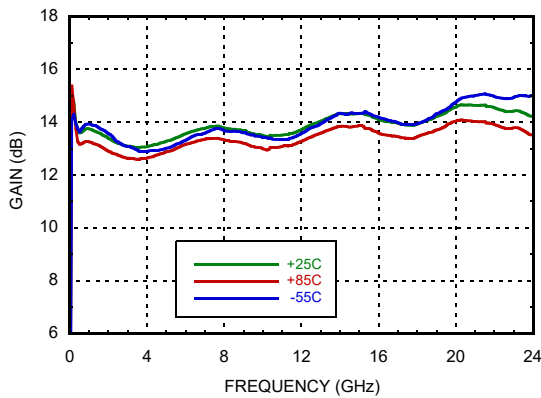

Input Return Loss vs. Temperature

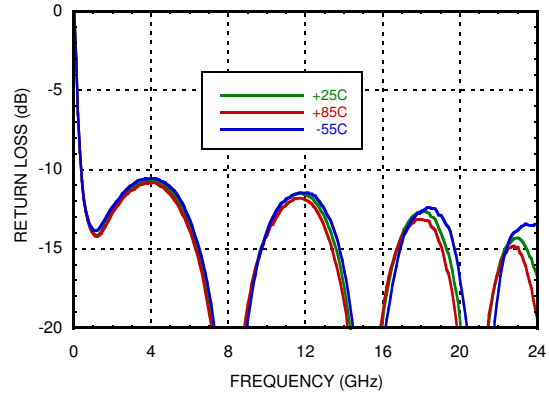

Output Return Loss vs. Temperature

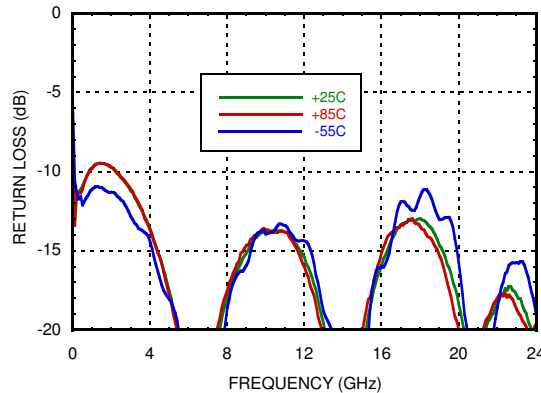

Gain vs. Supply Voltage

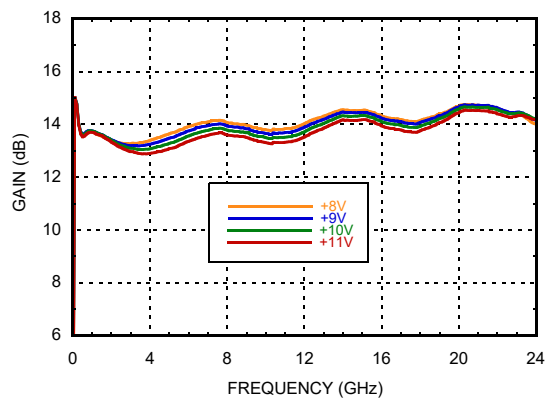

**GaAs pHEMT MMIC
POWER AMPLIFIER, 0.2 - 22 GHz**

Input Return Loss vs. Supply Voltage

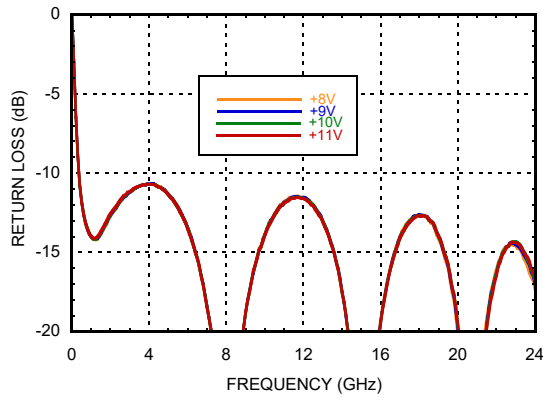

Output Return Loss vs. Supply Voltage

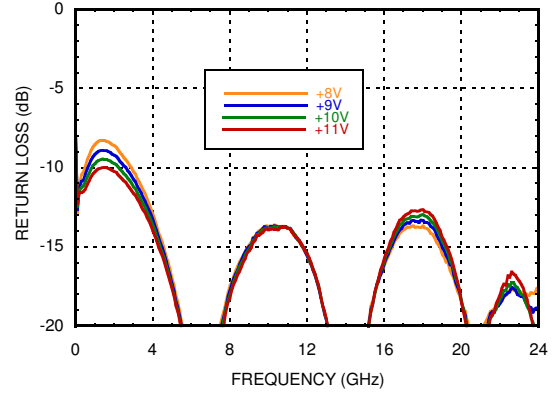

Reverse Isolation vs. Temperature

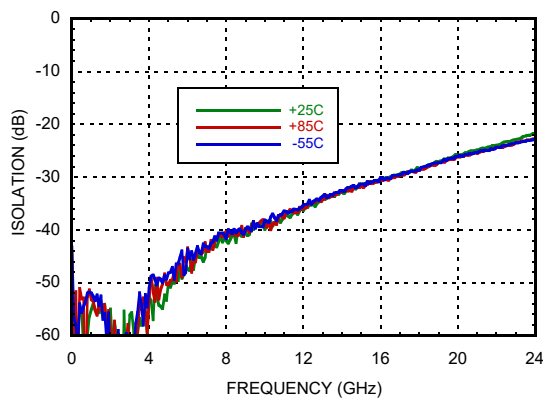

Noise Figure vs. Temperature

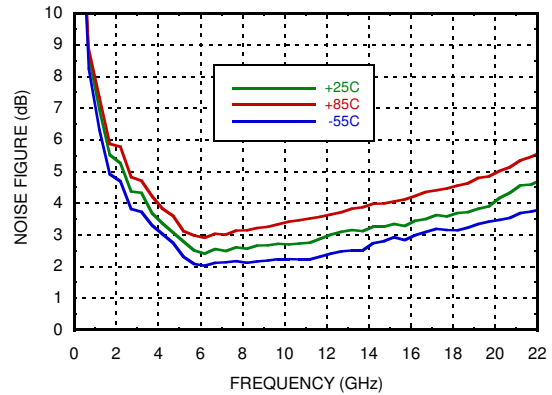

Low Frequency P1dB vs. Temperature

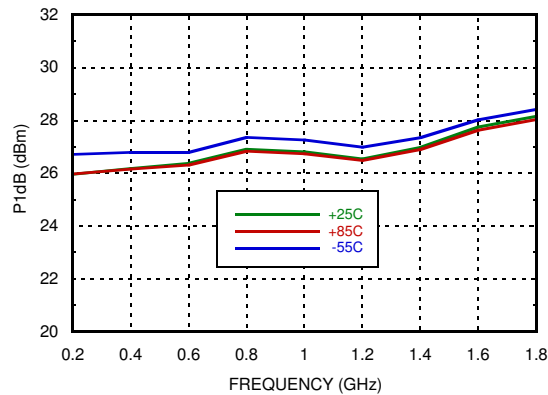

P1dB vs. Temperature

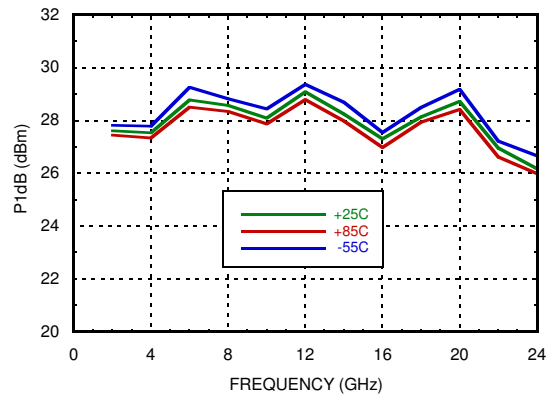

**GaAs pHEMT MMIC
POWER AMPLIFIER, 0.2 - 22 GHz**

P1dB vs. Supply Voltage

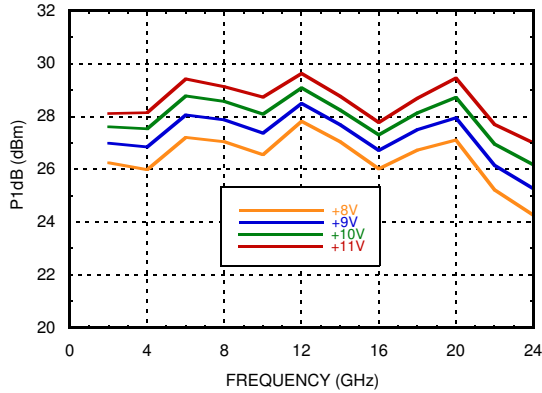

Low Frequency Psat vs. Temperature

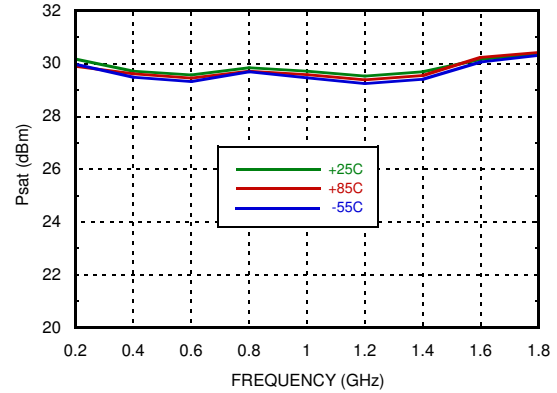

Psat vs. Temperature

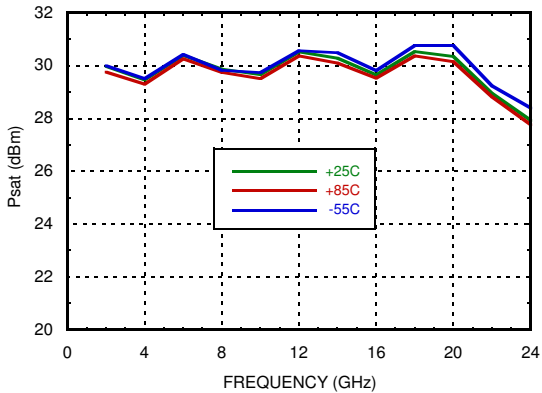

Psat vs. Supply Voltage

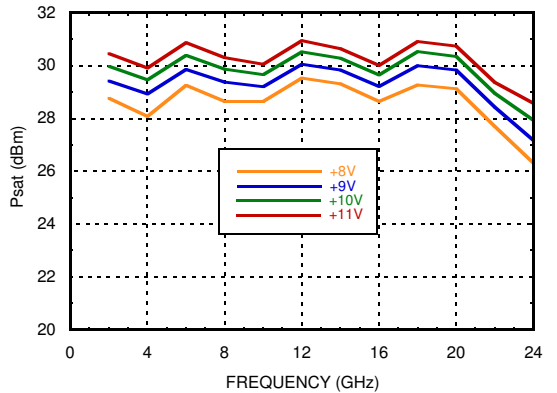

Power Compression @ 2 GHz

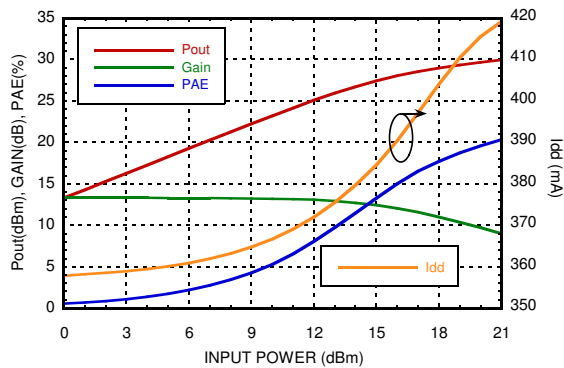

Power Compression @ 6 GHz

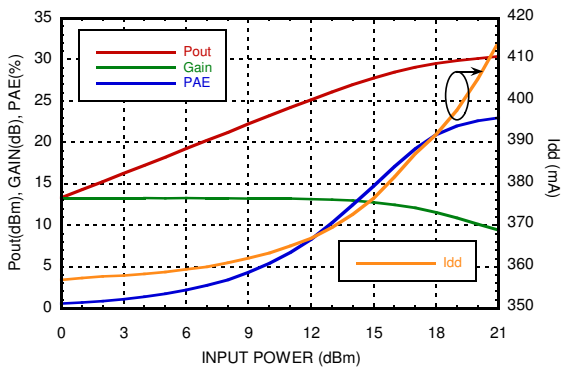

**GaAs pHEMT MMIC
POWER AMPLIFIER, 0.2 - 22 GHz**

AMPLIFIERS - LINEAR & POWER - CHIP

Power Compression @ 10 GHz

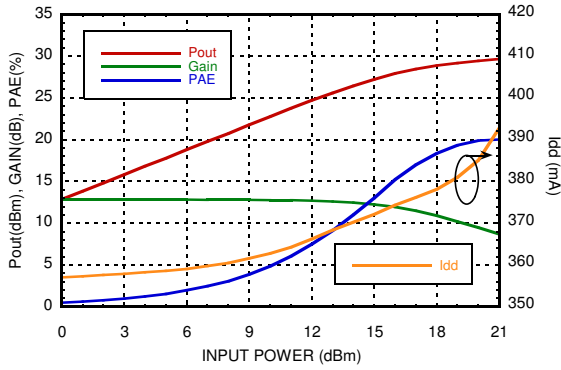

Power Compression @ 14 GHz

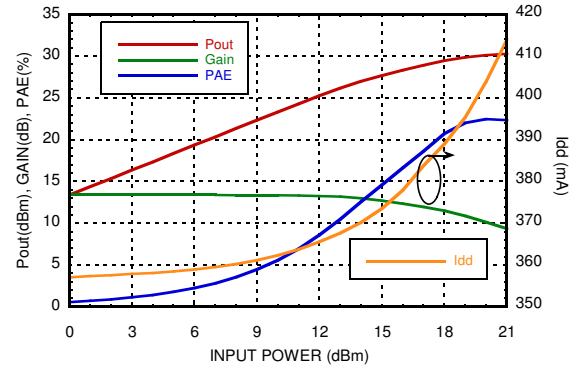

Power Compression @ 18 GHz

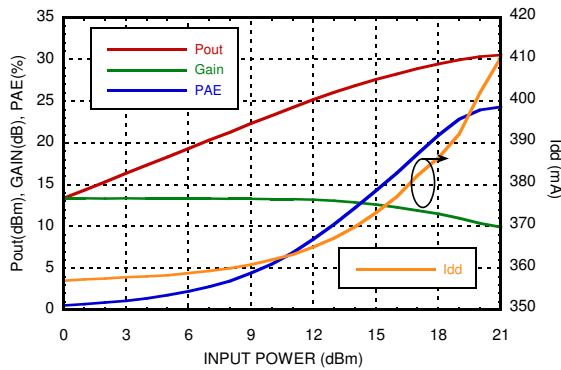

Power Compression @ 22 GHz

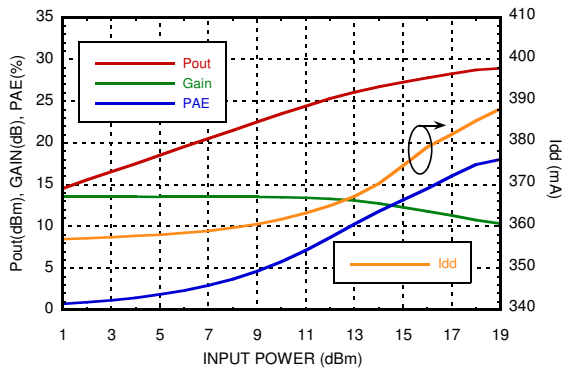

PAE @ Psat vs. Temperature

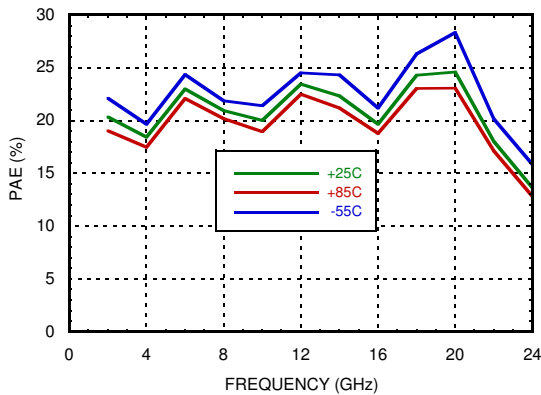

Power Dissipation @ +85 C

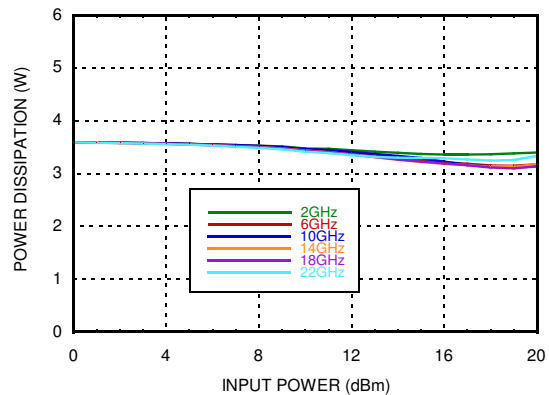

**GaAs pHEMT MMIC
POWER AMPLIFIER, 0.2 - 22 GHz**

**Gain & Power vs.
Supply Voltage @ 2 GHz**

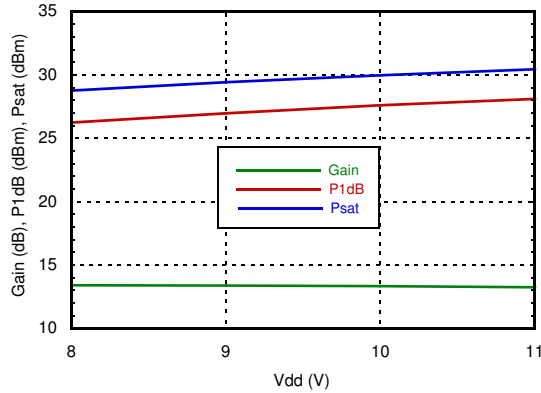

**Gain & Power vs.
Supply Voltage @ 6 GHz**

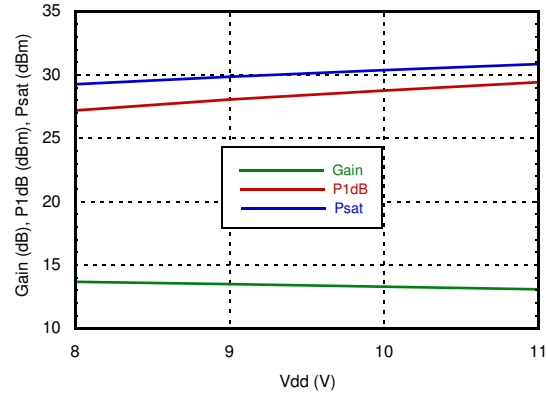

**Gain & Power vs.
Supply Voltage @ 10 GHz**

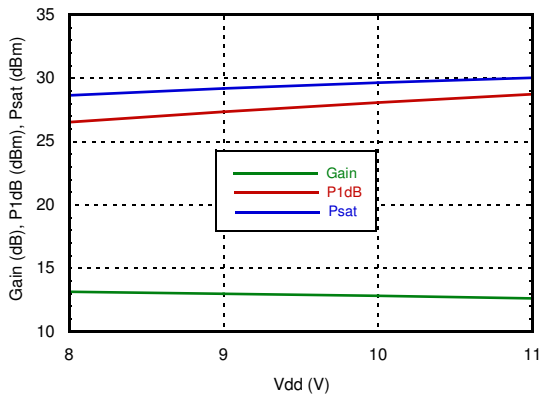

**Gain & Power vs.
Supply Voltage @ 14 GHz**

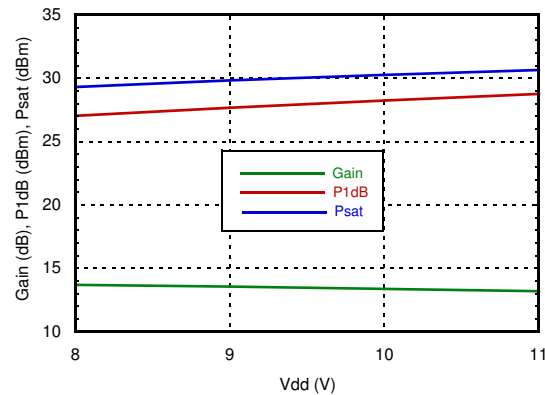

**Gain & Power vs.
Supply Voltage @ 18 GHz**

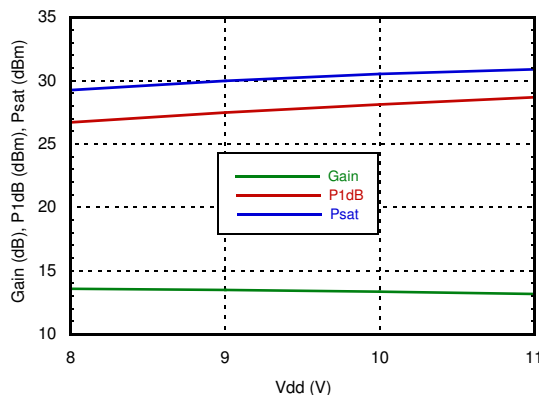

**Gain & Power vs.
Supply Voltage @ 22 GHz**

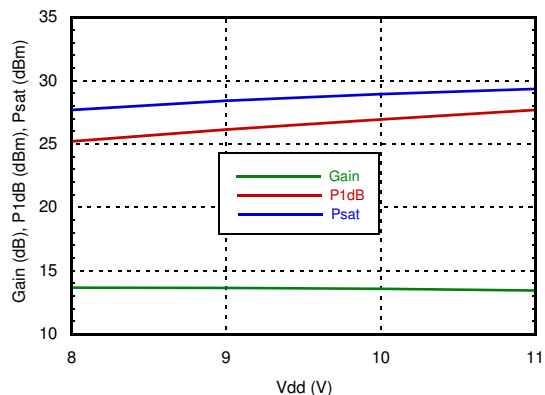

**GaAs pHEMT MMIC
POWER AMPLIFIER, 0.2 - 22 GHz**

**Low Frequency OIP3 vs. Temperature
@ Pout = +16 dBm / Tone**

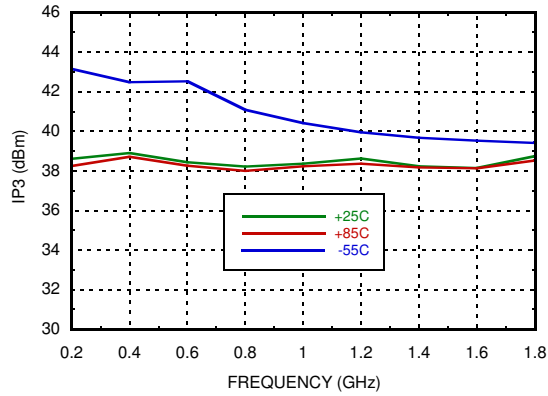

**OIP3 vs. Temperature
@ Pout = +16 dBm / Tone**

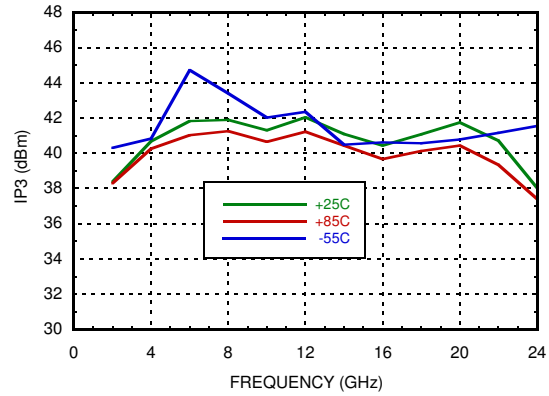

**OIP3 vs. Supply Voltage
@ Pout = +16 dBm / Tone**

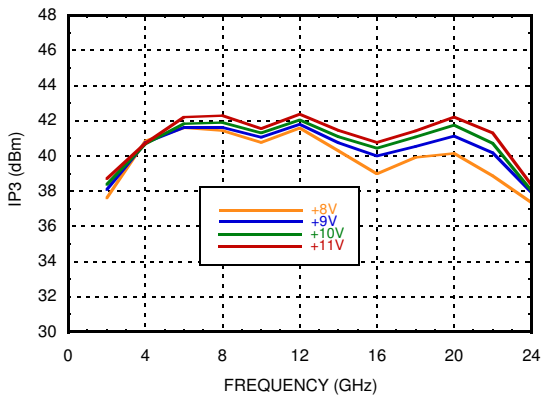

Output IM3 @ Vdd = +8V

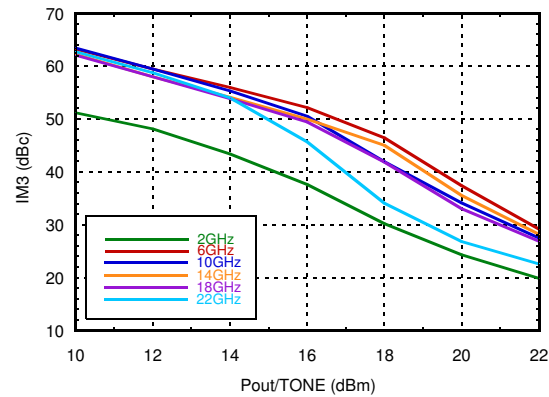

Output IM3 @ Vdd = +9V

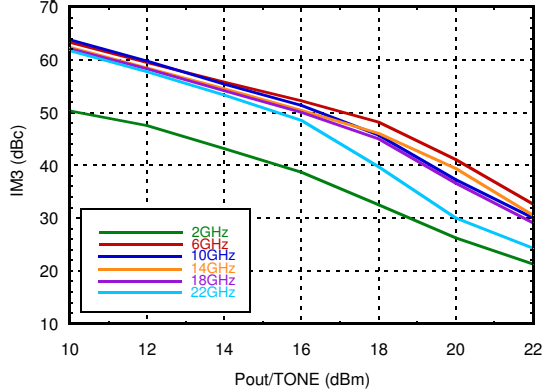

Output IM3 @ Vdd = +10V

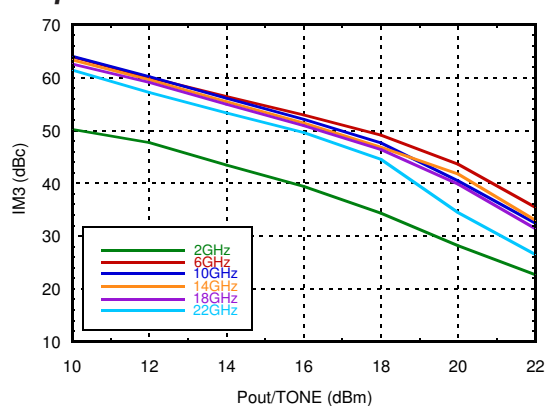

**GaAs pHEMT MMIC
POWER AMPLIFIER, 0.2 - 22 GHz**

Output IM3 @ Vdd = +11V

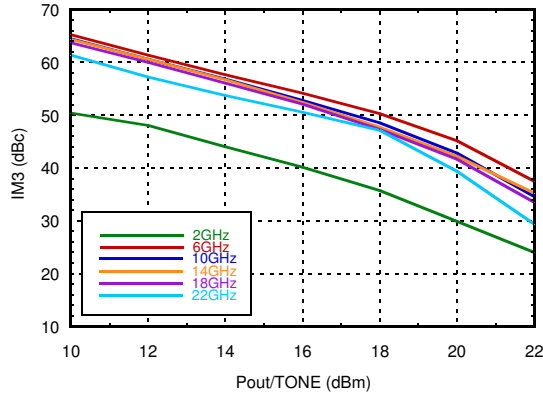

Second Harmonics vs. Temperature @ Pout = +16 dBm

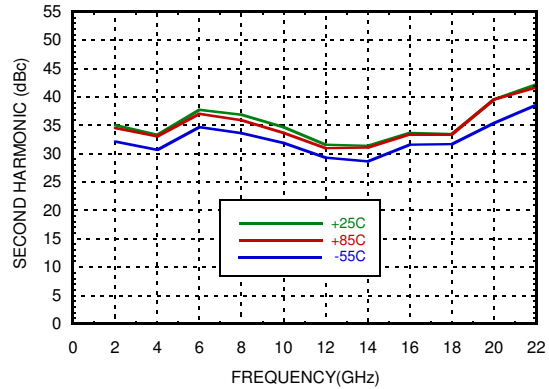

Second Harmonics vs. Supply Voltage @ Pout = +16 dBm

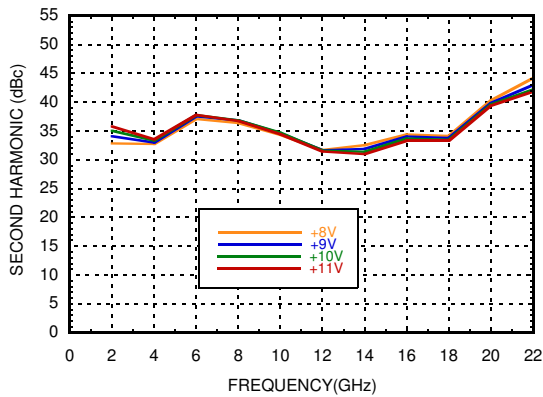

Second Harmonics vs. Pout

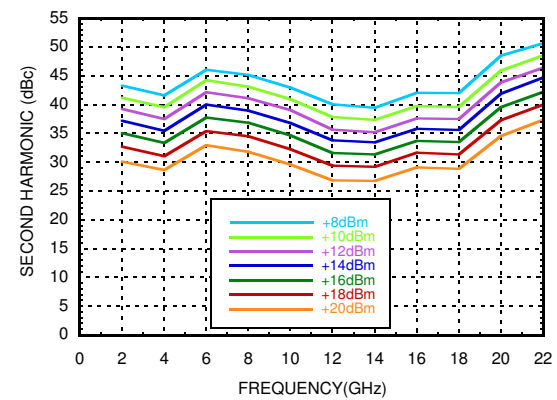

OIP2 vs. Temperature @ Pout = +16 dBm / Tone

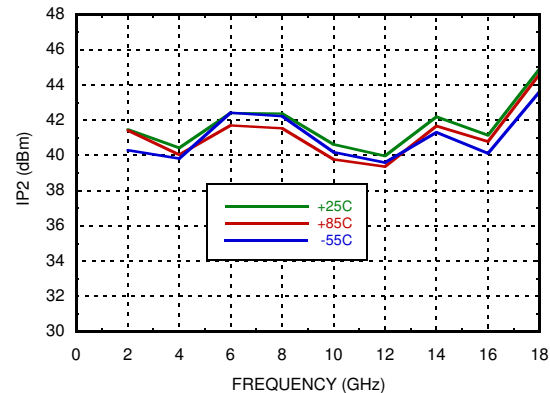

OIP2 vs. Supply Voltage @ Pout = +16 dBm / Tone

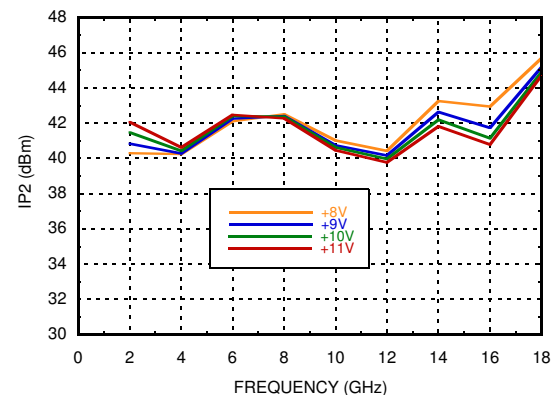

GaAs pHEMT MMIC POWER AMPLIFIER, 0.2 - 22 GHz

Supply Current vs. Supply Voltage

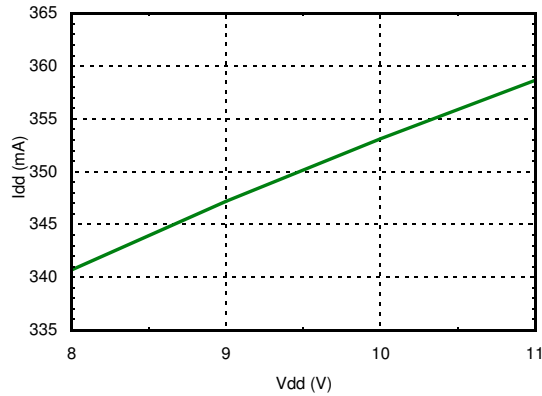

Absolute Maximum Ratings

Drain Bias Voltage (Vdd)	+12 Vdc
RF Input Power (RFIN)(Vdd = +10V)	+25 dBm
Output Load VSWR	7:1
Continuous Pdiss (T= 85 °C) (derate 62 mW/°C above 85 °C)	5.6 W
Storage Temperature	-65 to 150°C
Operating Temperature	-55 to 85 °C
ESD Sensitivity (HBM)	Class1A, Passed 250V

Reliability Information

Channel Temperature to Maintain 1 Million Hour MTTF	175 °C
Thermal Resistance (channel to die bottom)	16.2°C/W

Stresses at or above those listed in the Absolute Maximum Ratings may cause permanent damage to the product. This is a stress rating only, functional operation of the product at these or any other conditions above those indicated in the operational section of this specification is not implied. Operation beyond the maximum operating condition for extended periods may affect product reliability.



**ELECTROSTATIC SENSITIVE DEVICE
OBSERVE HANDLING PRECAUTIONS**

GaAs pHEMT MMIC POWER AMPLIFIER, 0.2 - 22 GHz

Outline Drawing

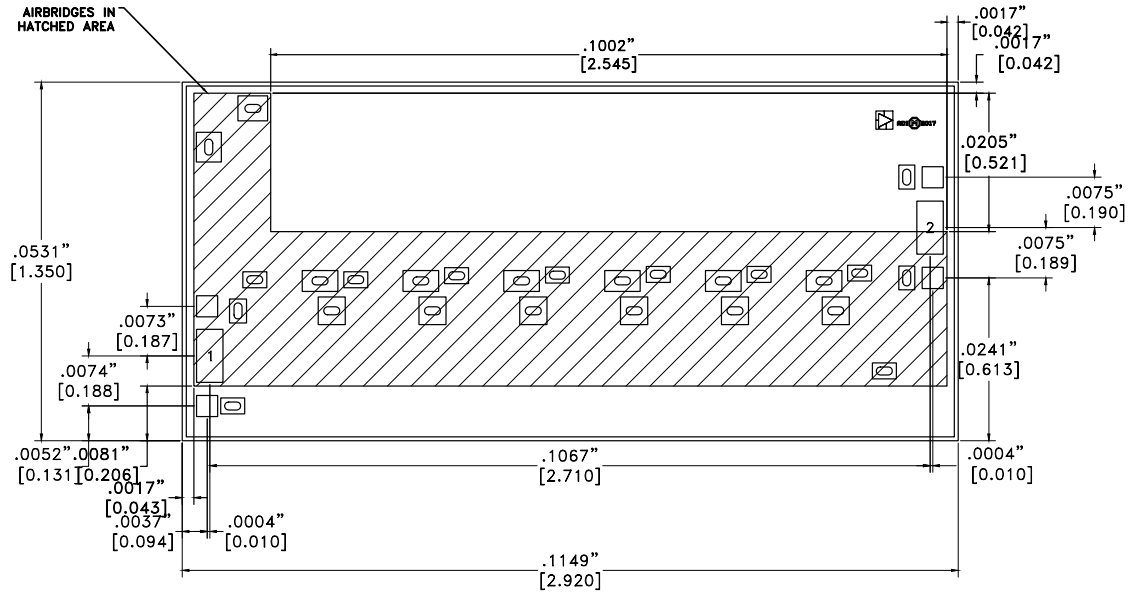

This die utilizes fragile air bridges. Any pick-up tools used must not contact the die in the cross hatched area.

Die Packaging Information ^[1]

Standard	Alternate
GP-2 (Gel Pack)	[2]

[1] Refer to the "Packaging Information" section for die packaging dimensions.

[2] For alternate packaging information contact Analog Devices, Inc..

NOTES:

1. ALL DIMENSIONS IN INCHES [MILLIMETERS]
2. DIE THICKNESS IS 0.004 (0.100)
3. TYPICAL BOND PAD IS 0.004 (0.100) SQUARE
4. BOND PAD METALIZATION: GOLD
5. BACKSIDE METALLIZATION: GOLD
6. BACKSIDE METAL IS GROUND
7. NO CONNECTION REQUIRED FOR UNLABELED BOND PADS
8. OVERALL DIE SIZE IS ± 0.02

Pad Descriptions

Pad Number	Function	Description	Interface Schematic
1	RFIN	This pad is DC coupled and matched to 50 Ohms.	
2	RFOUT & Vdd	RF output for amplifier. Connect DC bias (Vdd) network to provide drain current (Idd). See application circuit herein.	
Die Bottom	GND	Die bottom must be connected to RF/DC ground.	

**GaAs pHEMT MMIC
POWER AMPLIFIER, 0.2 - 22 GHz**

Assembly Diagram

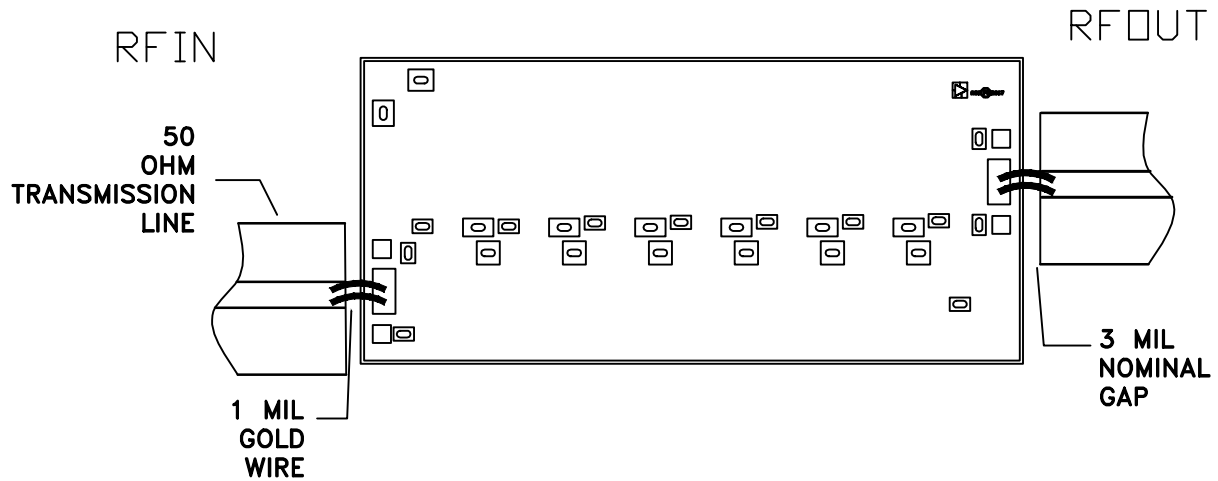

Application Circuit

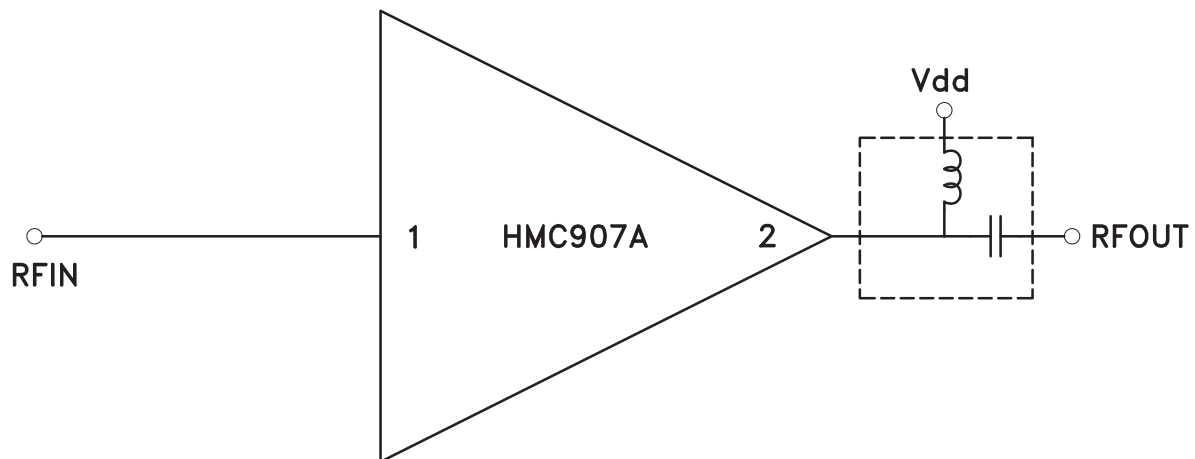

NOTE 1: Drain Bias (Vdd) must be applied through a broadband bias tee with low series resistance and capable of providing 500mA

GaAs pHEMT MMIC POWER AMPLIFIER, 0.2 - 22 GHz

Mounting & Bonding Techniques for Millimeterwave GaAs MMICs

The die should be attached directly to the ground plane eutectically or with conductive epoxy (see HMC general Handling, Mounting, Bonding Note).

50 Ohm Microstrip transmission lines on 0.127mm (5 mil) thick alumina thin film substrates are recommended for bringing RF to and from the chip (Figure 1). If 0.254mm (10 mil) thick alumina thin film substrates must be used, the die should be raised 0.150mm (6 mils) so that the surface of the die is coplanar with the surface of the substrate. One way to accomplish this is to attach the 0.102mm (4 mil) thick die to a 0.150mm (6 mil) thick molybdenum heat spreader (moly-tab) which is then attached to the ground plane (Figure 2).

Microstrip substrates should be placed as close to the die as possible in order to minimize bond wire length. Typical die-to-substrate spacing is 0.076mm to 0.152 mm (3 to 6 mils).

Handling Precautions

Follow these precautions to avoid permanent damage.

Storage: All bare die are placed in either Waffle or Gel based ESD protective containers, and then sealed in an ESD protective bag for shipment. Once the sealed ESD protective bag has been opened, all die should be stored in a dry nitrogen environment.

Cleanliness: Handle the chips in a clean environment. DO NOT attempt to clean the chip using liquid cleaning systems.

Static Sensitivity: Follow ESD precautions to protect against ESD strikes.

Transients: Suppress instrument and bias supply transients while bias is applied. Use shielded signal and bias cables to minimize inductive pick-up.

General Handling: Handle the chip along the edges with a vacuum collet or with a sharp pair of bent tweezers. The surface of the chip may have fragile air bridges and should not be touched with vacuum collet, tweezers, or fingers.

Mounting

The chip is back-metallized and can be die mounted with AuSn eutectic preforms or with electrically conductive epoxy. The mounting surface should be clean and flat.

Eutectic Die Attach: A 80/20 gold tin preform is recommended with a work surface temperature of 255 °C and a tool temperature of 265 °C. When hot 90/10 nitrogen/hydrogen gas is applied, tool tip temperature should be 290 °C. DO NOT expose the chip to a temperature greater than 320 °C for more than 20 seconds. No more than 3 seconds of scrubbing should be required for attachment.

Epoxy Die Attach: Apply a minimum amount of epoxy to the mounting surface so that a thin epoxy fillet is observed around the perimeter of the chip once it is placed into position. Cure epoxy per the manufacturer's schedule.

Wire Bonding

RF bonds made with two 1 mil wires are recommended. These bonds should be thermosonically bonded with a force of 40-60 grams. DC bonds of 0.001" (0.025 mm) diameter, thermosonically bonded, are recommended. Ball bonds should be made with a force of 40-50 grams and wedge bonds at 18-22 grams. All bonds should be made with a nominal stage temperature of 150 °C. A minimum amount of ultrasonic energy should be applied to achieve reliable bonds. All bonds should be as short as possible, less than 12 mils (0.31 mm).

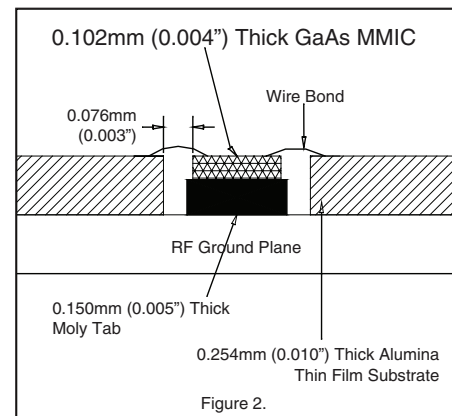
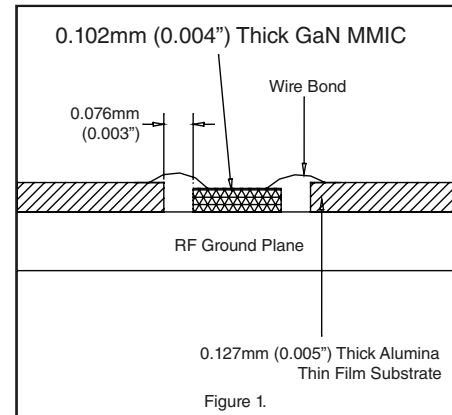

Mouser Electronics

Authorized Distributor

Click to View Pricing, Inventory, Delivery & Lifecycle Information:

[Analog Devices Inc.:](#)

[HMC907A-SX](#) [HMC907A](#)