

LOW NOISE AMPLIFIER MODULE, 5 - 9 GHz

Features

- Low Noise Figure: 1.75 dB @ 6 GHz
- High Gain: 22 dB
- Output IP3: +25 dBm
- P1dB Output Power: +14.8 dBm
- 50 Ohm Matched & DC Blocked RF I/Os
- Hermetically Sealed Module
- Field Replaceable SMA Connectors
- 55 °C to +85 °C Operating Temperature

Typical Applications

The HMC-C048 LNA is ideal for:

- Telecom Infrastructure
- Microwave Radio & VSAT
- Military & Space
- Test Instrumentation

Functional Diagram

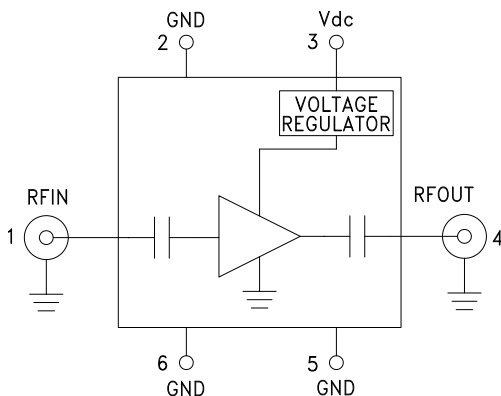

General Description

The HMC-C048 is a GaAs MMIC pHEMT Low Noise Amplifier in a miniature, hermetic module which operates between 5 and 9 GHz. This high dynamic range low noise amplifier module provides 22 dB of gain and up to +25 dBm of output IP3 while operating from a single positive supply between +8V and +16V. The amplifier I/Os are internally matched to 50 Ohms and DC blocked for robust performance. The module features removable coaxial connectors which can be detached to allow direct connection of the I/O pins to a microstrip or coplanar circuit.

Electrical Specifications, $T_A = +25^\circ\text{C}$, $V_{dc} = +12\text{V}$

Parameter	Min.	Typ.	Max.	Units
Frequency Range		5 - 9		GHz
Gain	18.5	22.5		dB
Gain Variation Over Temperature		0.015		dB/ °C
Noise Figure		1.75	2.3	dB
Input Return Loss		14		dB
Output Return Loss		15		dB
Output Power for 1 dB Compression (P1dB)	12	14.8		dBm
Saturated Output Power (Psat)		16.7		dBm
Output Third Order Intercept (IP3)		25		dBm
Supply Current		105	140	mA



**LOW NOISE AMPLIFIER
MODULE, 5 - 9 GHz**

Broadband Gain & Return Loss

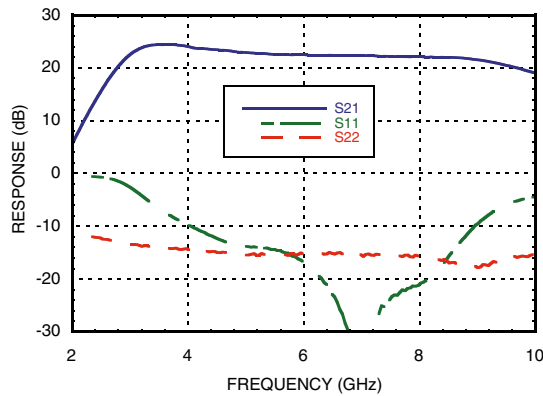

Gain vs. Temperature

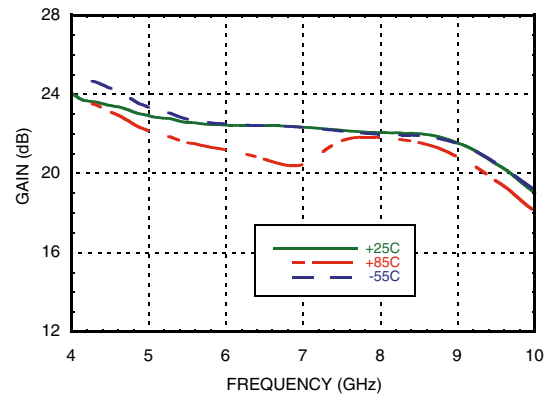

Input Return Loss vs. Temperature

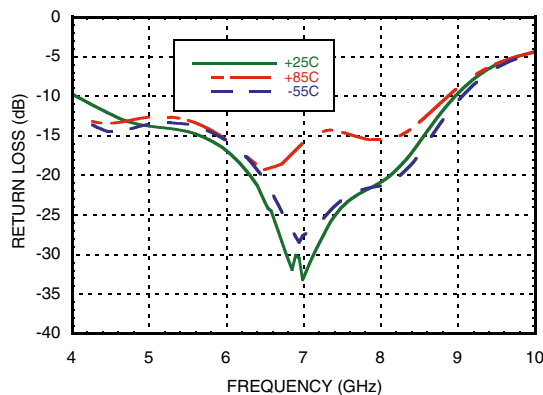

Output Return Loss vs. Temperature

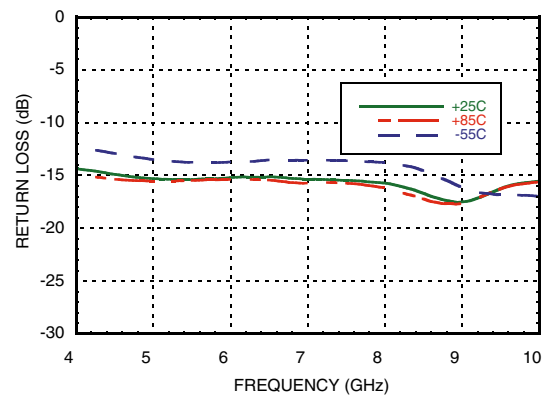

Reverse Isolation vs. Temperature

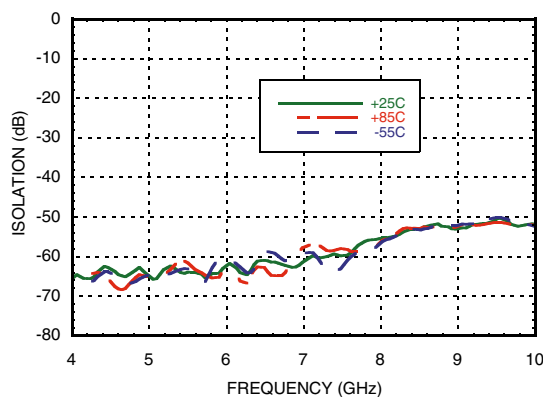

Noise Figure vs. Temperature

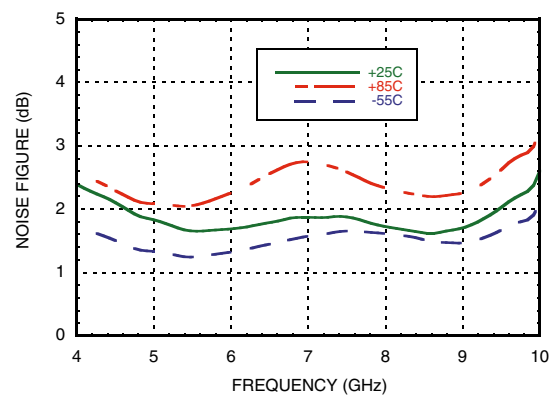



**LOW NOISE AMPLIFIER
MODULE, 5 - 9 GHz**

Output P1dB vs. Temperature

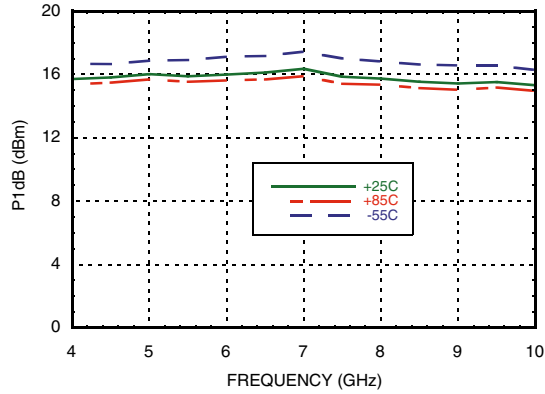

Psat vs. Temperature

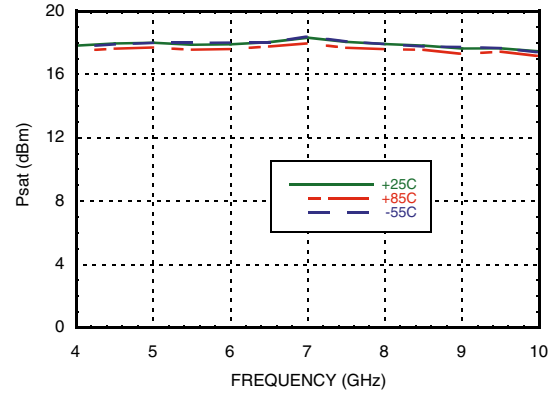

Output IP3 vs. Temperature

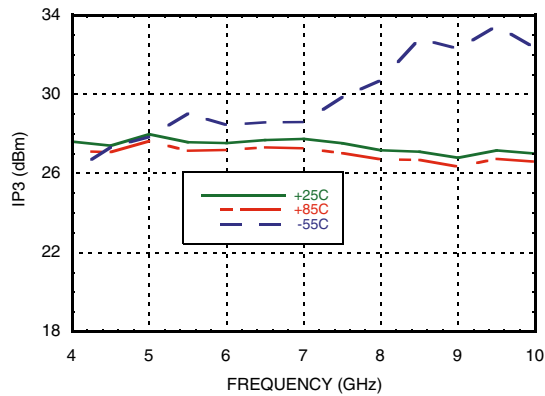



Absolute Maximum Ratings

Bias Supply Voltage (Vdc)	+16 Vdc
RF Input Power (RFIN)	+0 dBm
Storage Temperature	-65 to +150 °C
Operating Temperature	-55 to +85 °C



**ELECTROSTATIC SENSITIVE DEVICE
OBSERVE HANDLING PRECAUTIONS**

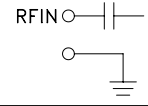

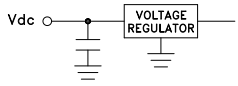
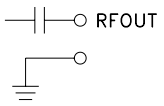
**LOW NOISE AMPLIFIER
MODULE, 5 - 9 GHz**
Pin Descriptions

Pin Number	Function	Description	Interface Schematic
1	RFIN & RF Ground	RF input connector, coaxial female, field replaceable. This pin is AC coupled and matched to 50 Ohms.	
2, 5, 6	GND	One of these pins must be connected to power supply ground.	
3	Vdc	Power supply voltage for the amplifier.	
4	RFOUT & RF Ground	RF output connector, coaxial female, field replaceable. This pin is AC coupled and matched to 50 Ohms.	

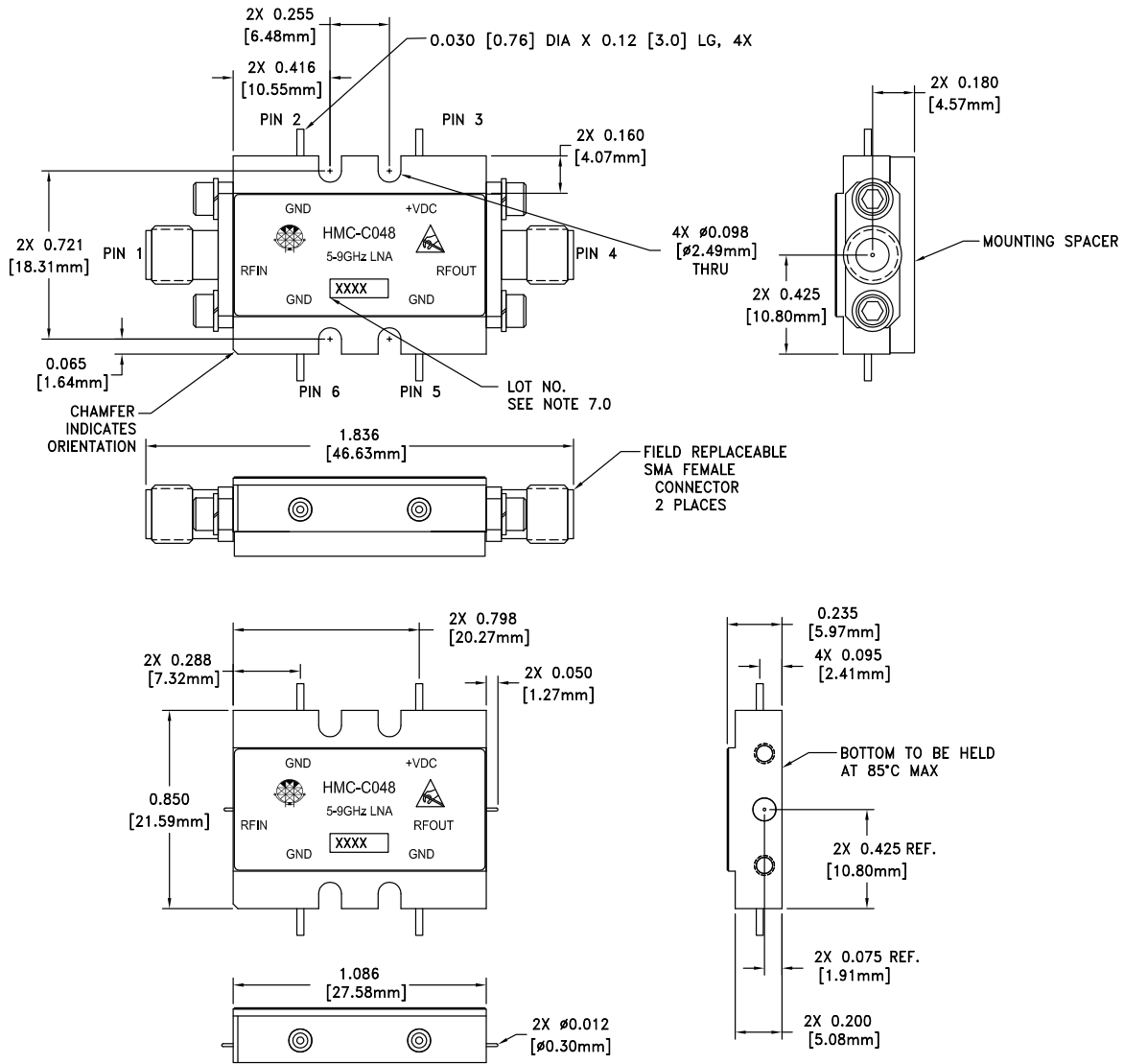

**LOW NOISE AMPLIFIER
MODULE, 5 - 9 GHz**

Outline Drawing



VIEW SHOWN WITH CONNECTORS AND MOUNTING SPACER REMOVED

Package Information

Package Type	C-10
Package Weight [1]	18.7 gms [2]
Spacer Weight	3.3 gms [2]

[1] Includes the connectors

[2] ±1 gms Tolerance

NOTES:

1. PACKAGE, LEADS, COVER MATERIAL: KOVAR™
2. FINISH: GOLD PLATE OVER NICKEL PLATE
3. ALL DIMENSIONS ARE IN INCHES [MILLIMETERS]
4. TOLERANCES:
 - 4.1 .XX = ±0.02
 - 4.2 .XXX = ±0.010
5. FIELD REPLACEABLE SMA CONNECTORS

**LOW NOISE AMPLIFIER
MODULE, 5 - 9 GHz****Notes:**

Mouser Electronics

Authorized Distributor

Click to View Pricing, Inventory, Delivery & Lifecycle Information:

[Analog Devices Inc.:](#)

[HMC-C048](#)