

EasyDUAL Modul mit CoolSiC™ Trench MOSFET und PressFIT / NTC / TIM
 EasyDUAL module with CoolSiC™ Trench MOSFET and PressFIT / NTC / TIM

Vorläufige Daten / Preliminary Data

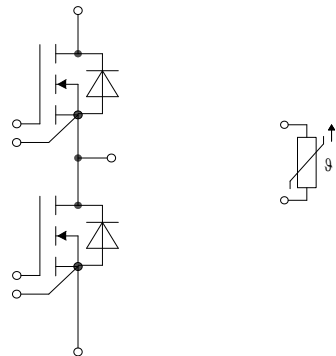
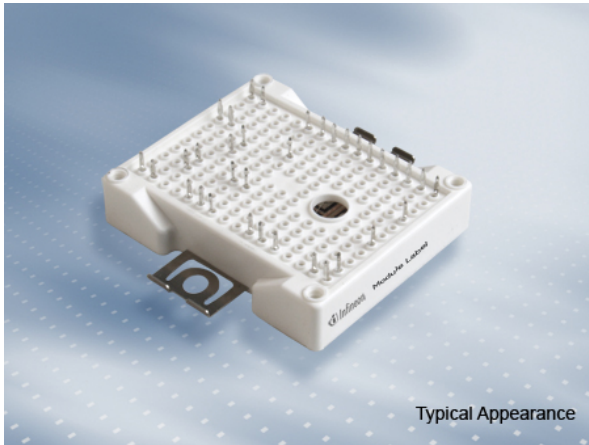

$V_{DSS} = 1200V$
 $I_{D\ nom} = 150A / I_{DRM} = 300A$

Potentielle Anwendungen

- Anwendungen mit hohen Schaltfrequenzen
- DC/DC Wandler
- Solar Anwendungen
- USV-Systeme

Potential Applications

- High Frequency Switching application
- DC/DC converter
- Solar applications
- UPS systems

Elektrische Eigenschaften

- Hohe Stromdichte
- Niederinduktives Design
- Niedrige Schaltverluste

Electrical Features

- High current density
- Low inductive design
- Low switching losses

Mechanische Eigenschaften

- Integrierter NTC Temperatur Sensor
- PressFIT Verbindungstechnik
- Robuste Montage durch integrierte Befestigungsklammern
- Thermisches Interface Material bereits aufgetragen

Mechanical Features

- Integrated NTC temperature sensor
- PressFIT contact technology
- Rugged mounting due to integrated mounting clamps
- Pre-applied Thermal Interface Material

Module Label Code

Barcode Code 128



DMX - Code



Content of the Code

Content of the Code	Digit
Module Serial Number	1 - 5
Module Material Number	6 - 11
Production Order Number	12 - 19
Datecode (Production Year)	20 - 21
Datecode (Production Week)	22 - 23

MOSFET / MOSFET

Höchstzulässige Werte / Maximum Rated Values

Drain-Source-Spannung Drain-source voltage	$T_{vj} = 25^{\circ}\text{C}$	V_{DSS}	1200	V
Drain-Gleichstrom DC drain current	$T_{vj} = 175^{\circ}\text{C}, V_{GS} = 15\text{ V}$	$T_H = 40^{\circ}\text{C}$	$I_{D\text{ nom}}$	150 A
Gepulster Drainstrom Pulsed drain current	verifiziert durch Design, t_p limitiert durch $T_{vj\text{ max}}$ verified by design, t_p limited by $T_{vj\text{ max}}$		$I_{D\text{ pulse}}$	300 A
Gate-Source Spannung Gate-source voltage		V_{GSS}	-10 / 20	V

Charakteristische Werte / Characteristic Values

			min.	typ.	max.	
Einschaltwiderstand Drain-source on resistance	$I_D = 150\text{ A}$ $V_{GS} = 15\text{ V}$	$T_{vj} = 25^{\circ}\text{C}$ $T_{vj} = 125^{\circ}\text{C}$ $T_{vj} = 150^{\circ}\text{C}$	$R_{DS\text{ on}}$	7,50 9,83 11,0		m Ω
Gate-Schwellenspannung Gate threshold voltage	$I_D = 60,0\text{ mA}, V_{DS} = V_{GS}, T_{vj} = 25^{\circ}\text{C}$ (tested after 1ms pulse at $V_{GS} = +20\text{ V}$)		$V_{GS(th)}$	3,45 4,50 5,55		V
Gesamt Gateladung Total gate charge	$V_{GS} = -5\text{ V} / 15\text{ V}, V_{DS} = 800\text{ V}$		Q_G	0,372		μC
Interner Gatewiderstand Internal gate resistor	$T_{vj} = 25^{\circ}\text{C}$		R_{Gint}	0,7		Ω
Eingangskapazität Input capacitance	$f = 1\text{ MHz}, T_{vj} = 25^{\circ}\text{C}$ $V_{DS} = 800\text{ V}, V_{GS} = 0\text{ V}, V_{AC} = 25\text{ mV}$		C_{iss}	11,0		nF
Ausgangskapazität Output capacitance	$f = 1\text{ MHz}, T_{vj} = 25^{\circ}\text{C}$ $V_{DS} = 800\text{ V}, V_{GS} = 0\text{ V}, V_{AC} = 25\text{ mV}$		C_{oss}	0,66		nF
Rückwirkungskapazität Reverse transfer capacitance	$f = 1\text{ MHz}, T_{vj} = 25^{\circ}\text{C}$ $V_{DS} = 800\text{ V}, V_{GS} = 0\text{ V}, V_{AC} = 25\text{ mV}$		C_{rss}	0,084		nF
C_{oss} Speicherenergie C_{oss} stored energy	$T_{vj} = 25^{\circ}\text{C}$ $V_{DS} = 800\text{ V}, V_{GS} = -5\text{ V} / 15\text{ V}$		E_{oss}	264		μJ
Drain-Source-Reststrom Zero gate voltage drain current	$V_{DS} = 1200\text{ V}, V_{GS} = -5\text{ V}$	$T_{vj} = 25^{\circ}\text{C}$	I_{DSS}	0,60	530	μA
Gate-Source-Reststrom Gate-source leakage current	$V_{DS} = 0\text{ V}$ $T_{vj} = 25^{\circ}\text{C}$	$V_{GS} = 20\text{ V}$ $V_{GS} = -10\text{ V}$	I_{GSS}		400	nA
Einschaltverzögerungszeit, induktive Last Turn on delay time, inductive load	$I_D = 150\text{ A}, V_{DS} = 600\text{ V}$ $V_{GS} = -5\text{ V} / 15\text{ V}$ $R_{Gon} = 2,40\ \Omega$	$T_{vj} = 25^{\circ}\text{C}$ $T_{vj} = 125^{\circ}\text{C}$ $T_{vj} = 150^{\circ}\text{C}$	$t_{d\text{ on}}$	21,5 20,0 19,5		ns
Anstiegszeit, induktive Last Rise time, inductive load	$I_D = 150\text{ A}, V_{DS} = 600\text{ V}$ $V_{GS} = -5\text{ V} / 15\text{ V}$ $R_{Gon} = 2,40\ \Omega$	$T_{vj} = 25^{\circ}\text{C}$ $T_{vj} = 125^{\circ}\text{C}$ $T_{vj} = 150^{\circ}\text{C}$	t_r	16,5 16,0 16,0		ns
Abschaltverzögerungszeit, induktive Last Turn off delay time, inductive load	$I_D = 150\text{ A}, V_{DS} = 600\text{ V}$ $V_{GS} = -5\text{ V} / 15\text{ V}$ $R_{Goff} = 2,40\ \Omega$	$T_{vj} = 25^{\circ}\text{C}$ $T_{vj} = 125^{\circ}\text{C}$ $T_{vj} = 150^{\circ}\text{C}$	$t_{d\text{ off}}$	57,0 61,0 61,0		ns
Fallzeit, induktive Last Fall time, inductive load	$I_D = 150\text{ A}, V_{DS} = 600\text{ V}$ $V_{GS} = -5\text{ V} / 15\text{ V}$ $R_{Goff} = 2,40\ \Omega$	$T_{vj} = 25^{\circ}\text{C}$ $T_{vj} = 125^{\circ}\text{C}$ $T_{vj} = 150^{\circ}\text{C}$	t_f	28,0 28,5 28,5		ns
Einschaltverlustenergie pro Puls Turn-on energy loss per pulse	$I_D = 150\text{ A}, V_{DS} = 600\text{ V}, L_{\sigma} = 35\text{ nH}$ $di/dt = 11,0\text{ kA}/\mu\text{s}$ ($T_{vj} = 150^{\circ}\text{C}$) $V_{GS} = -5\text{ V} / 15\text{ V}, R_{Gon} = 2,40\ \Omega$	$T_{vj} = 25^{\circ}\text{C}$ $T_{vj} = 125^{\circ}\text{C}$ $T_{vj} = 150^{\circ}\text{C}$	E_{on}	2,00 2,10 2,20		mJ
Abschaltverlustenergie pro Puls Turn-off energy loss per pulse	$I_D = 150\text{ A}, V_{DS} = 600\text{ V}, L_{\sigma} = 35\text{ nH}$ $du/dt = 25,0\text{ kV}/\mu\text{s}$ ($T_{vj} = 150^{\circ}\text{C}$) $V_{GS} = -5\text{ V} / 15\text{ V}, R_{Goff} = 2,40\ \Omega$	$T_{vj} = 25^{\circ}\text{C}$ $T_{vj} = 125^{\circ}\text{C}$ $T_{vj} = 150^{\circ}\text{C}$	E_{off}	0,76 0,77 0,77		mJ
Kurzschlußverhalten SC data	$V_{GS} = -5\text{ V} / 15\text{ V}, V_{DD} = 800\text{ V}$ $V_{DS\text{ max}} = V_{DSS} - L_{SDS} \cdot di/dt$ $R_G = 10,0\ \Omega$	$t_p \leq 2\ \mu\text{s}, T_{vj} = 25^{\circ}\text{C}$ $t_p \leq 2\ \mu\text{s}, T_{vj} = 150^{\circ}\text{C}$	I_{SC}	1260 1230		A A
Wärmewiderstand, Chip bis Kühlkörper Thermal resistance, junction to heatsink	pro MOSFET / per MOSFET		$R_{th\text{ JH}}$		0,314	K/W
Temperatur im Schaltbetrieb Temperature under switching conditions			$T_{vj\text{ op}}$	-40	150	$^{\circ}\text{C}$

Body Diode / Body diode

Höchstzulässige Werte / Maximum Rated Values

Body Diode-Gleichstrom DC body diode forward current	$T_{vj} = 175^{\circ}\text{C}, V_{GS} = -5\text{ V}$	$T_H = 40^{\circ}\text{C}$	I_{SD}	48	A
---	--	----------------------------	----------	----	---

Charakteristische Werte / Characteristic Values

			min.	typ.	max.	
Durchlassspannung Forward voltage	$I_{SD} = 150\text{ A}, V_{GS} = -5\text{ V}$ $I_{SD} = 150\text{ A}, V_{GS} = -5\text{ V}$ $I_{SD} = 150\text{ A}, V_{GS} = -5\text{ V}$	$T_{vj} = 25^{\circ}\text{C}$ $T_{vj} = 125^{\circ}\text{C}$ $T_{vj} = 150^{\circ}\text{C}$	V_{SD}	4,60 4,35 4,30	5,65	V

Vorläufige Daten Preliminary Data

NTC-Widerstand / NTC-Thermistor Charakteristische Werte / Characteristic Values

			min.	typ.	max.	
Nennwiderstand Rated resistance	$T_{NTC} = 25^{\circ}\text{C}$	R_{25}		5,00		k Ω
Abweichung von R100 Deviation of R100	$T_{NTC} = 100^{\circ}\text{C}, R_{100} = 493 \Omega$	$\Delta R/R$	-5		5	%
Verlustleistung Power dissipation	$T_{NTC} = 25^{\circ}\text{C}$	P_{25}			20,0	mW
B-Wert B-value	$R_2 = R_{25} \exp [B_{25/50}(1/T_2 - 1/(298,15 \text{ K}))]$	$B_{25/50}$		3375		K
B-Wert B-value	$R_2 = R_{25} \exp [B_{25/80}(1/T_2 - 1/(298,15 \text{ K}))]$	$B_{25/80}$		3411		K
B-Wert B-value	$R_2 = R_{25} \exp [B_{25/100}(1/T_2 - 1/(298,15 \text{ K}))]$	$B_{25/100}$		3433		K

Angaben gemäß gültiger Application Note.
Specification according to the valid application note.

Modul / Module

Isolations-Prüfspannung Isolation test voltage	RMS, f = 50 Hz, t = 1 min.	V_{ISOL}		3,0		kV
Innere Isolation Internal isolation	Basisisolation (Schutzklasse 1, EN61140) basic insulation (class 1, IEC 61140)			Al_2O_3		
Kriechstrecke Creepage distance	Kontakt - Kühlkörper / terminal to heatsink Kontakt - Kontakt / terminal to terminal			11,5 6,3		mm
Luftstrecke Clearance	Kontakt - Kühlkörper / terminal to heatsink Kontakt - Kontakt / terminal to terminal			10,0 5,0		mm
Vergleichszahl der Kriechwegbildung Comperative tracking index		CTI		> 200		
Relativer Temperaturindex (elektr.) RTI Elec.	Gehäuse housing	RTI		140		$^{\circ}\text{C}$
			min.	typ.	max.	
Modulstreuintuktivität Stray inductance module		L_{sCE}		8,0		nH
Modulleitungswiderstand, Anschlüsse - Chip Module lead resistance, terminals - chip	$T_H = 25^{\circ}\text{C}$, pro Schalter / per switch	$R_{CC+EE'}$		0,50		m Ω
Lagertemperatur Storage temperature		T_{stg}	-40		125	$^{\circ}\text{C}$
Höchstzulässige Bodenplattenbetriebstemperatur Maximum baseplate operation temperature		T_{BPmax}			125	$^{\circ}\text{C}$
Anpresskraft für mech. Bef. pro Feder mounting force per clamp		F	40	-	80	N
Gewicht Weight		G		39		g

The current under continuous operation is limited to 25 A rms per connector pin.
Important note: The selection of positive and negative gate-source voltages impacts the long-term behavior of the device. The design guidelines described in AN 2018-09 must be considered to ensure sound operation of the device over the planned lifetime.
Storage and shipment of modules with TIM => see AN2012-07

Vorläufige Daten Preliminary Data

Ausgangskennlinie MOSFET (typisch) output characteristic MOSFET (typical)

$I_D = f(V_{DS})$
 $V_{GS} = 15\text{ V}$

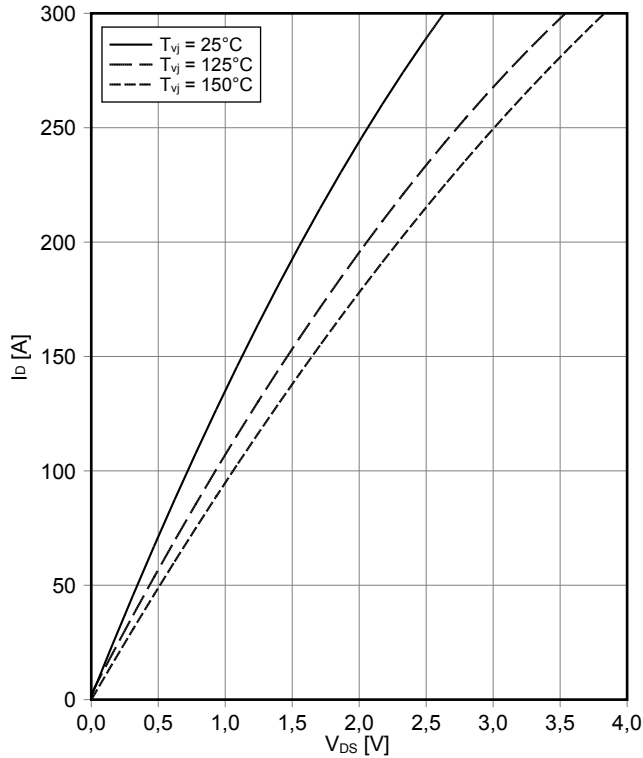

Übertragungscharakteristik MOSFET (typisch) transfer characteristic MOSFET (typical)

$I_D = f(V_{GS})$
 $V_{DS} = 20\text{ V}$

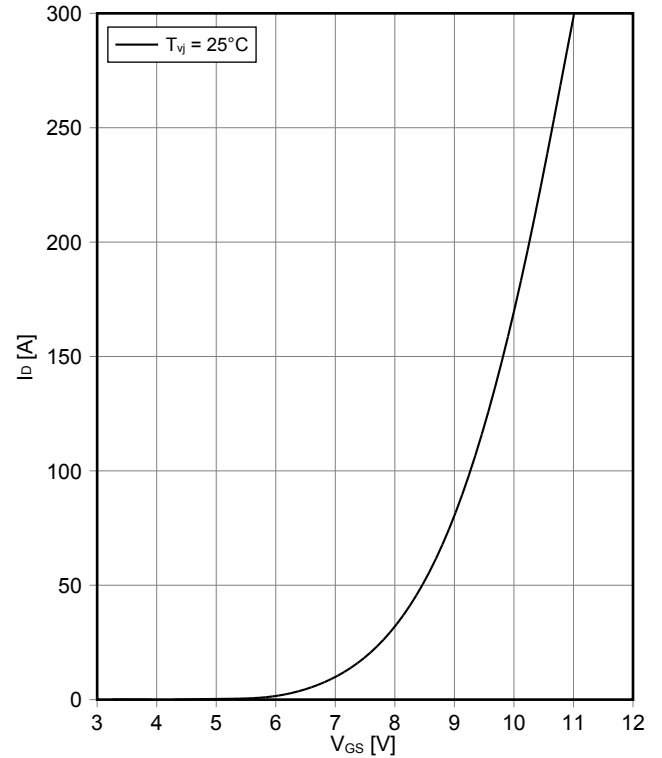

Schaltverluste MOSFET (typisch) switching losses MOSFET (typical)

$E_{on} = f(I_D), E_{off} = f(I_D)$
 $V_{GS} = -5\text{ V} / 15\text{ V}, R_{Gon} = 2,4\ \Omega, R_{Goff} = 2,4\ \Omega, V_{DS} = 600\text{ V}$

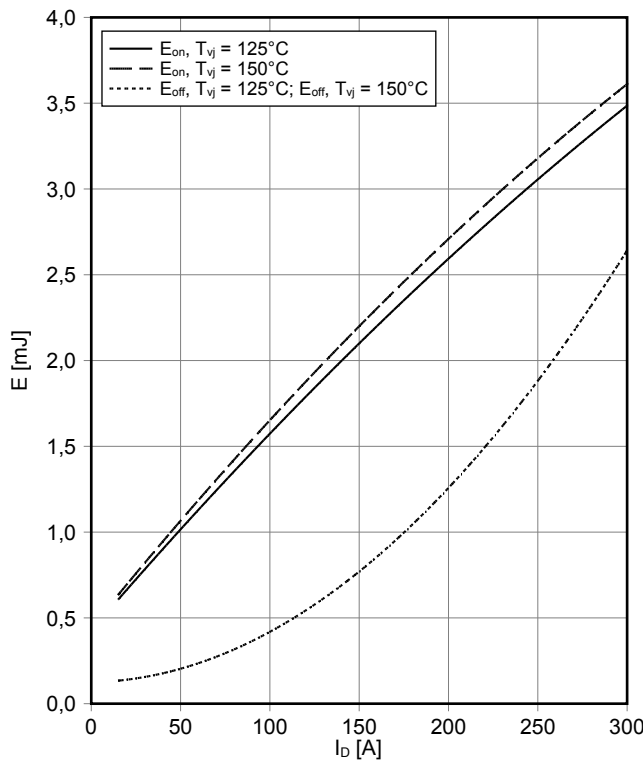

Schaltverluste MOSFET (typisch) switching losses MOSFET (typical)

$E_{on} = f(R_G), E_{off} = f(R_G)$
 $V_{GS} = -5\text{ V} / 15\text{ V}, I_D = 150\text{ A}, V_{DS} = 600\text{ V}$

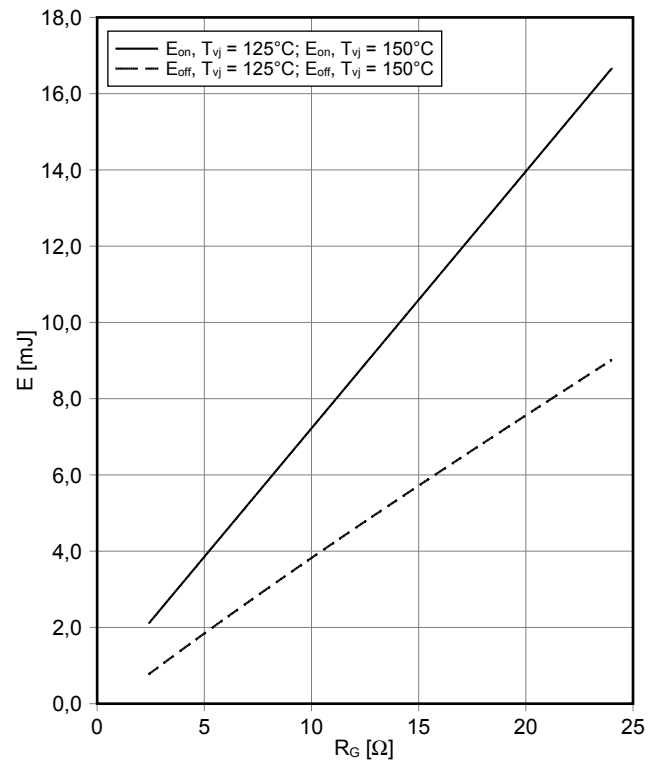

Vorläufige Daten Preliminary Data

Sicherer Rückwärts-Arbeitsbereich MOSFET (RBSOA) reverse bias safe operating area MOSFET (RBSOA)

$I_D = f(V_{DS})$
 $V_{GS} = -5\text{ V} / +15\text{ V}$, $T_{vj} = 150^\circ\text{C}$, $R_G = 2,4\ \Omega$

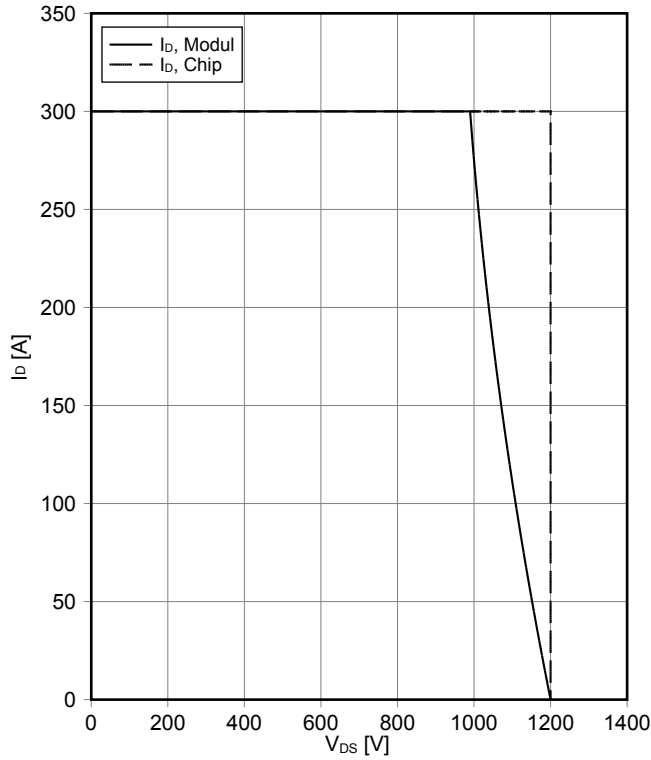

Transienter Wärmewiderstand MOSFET transient thermal impedance MOSFET

$Z_{thJH} = f(t)$

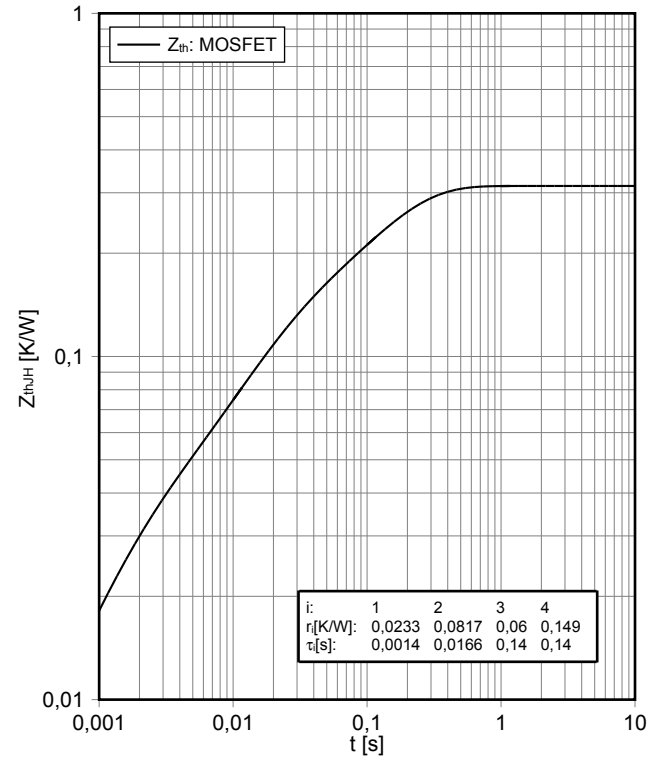

NTC-Widerstand-Temperaturkennlinie (typisch) NTC-Thermistor-temperature characteristic (typical)

$R = f(T_{NTC})$

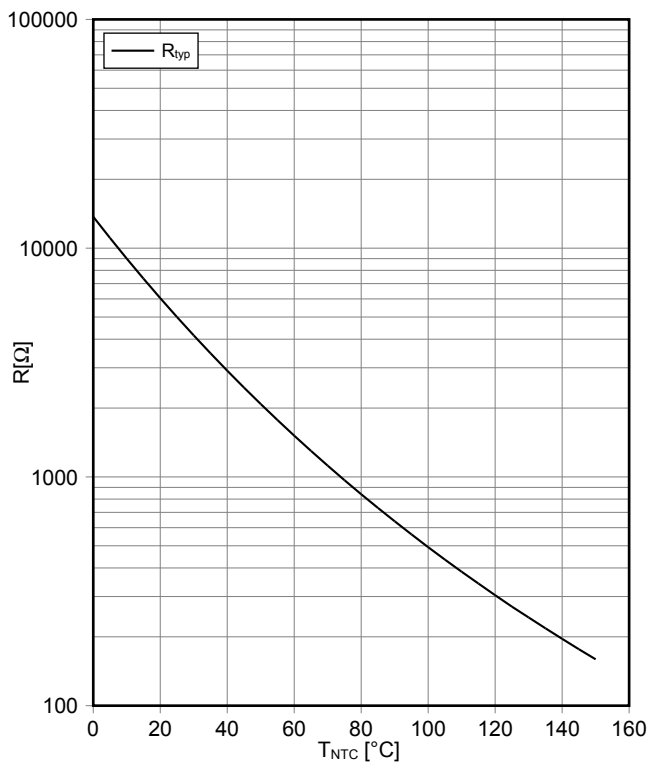

Schaltplan / Circuit diagram

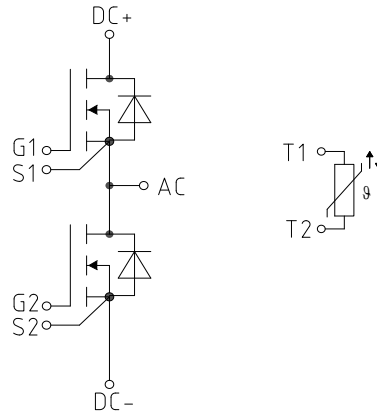

Gehäuseabmessungen / Package outlines

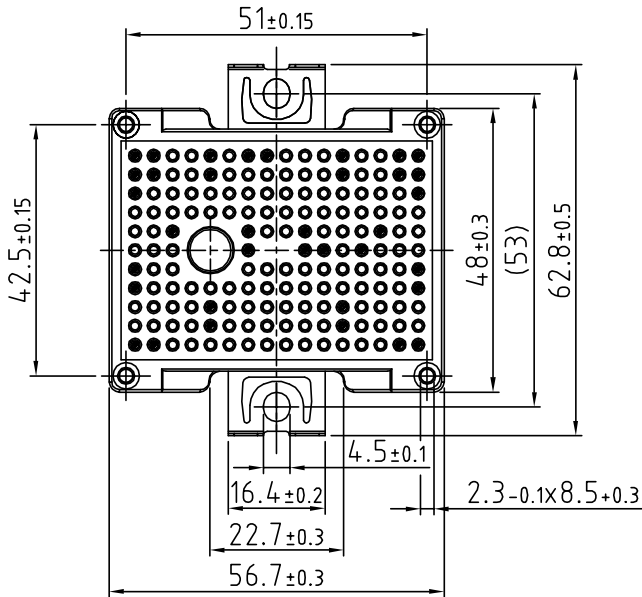
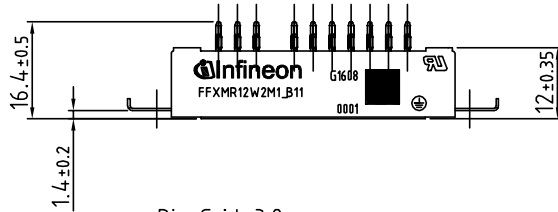
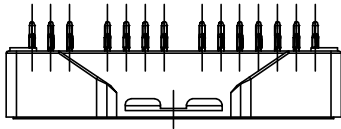

- Pin-Grid 3.2mm
- Tolerance of PCB hole pattern $\begin{matrix} \oplus \\ \ominus \end{matrix} \phi 0.1$
- Hole specification for contacts see AN 2009-01:
Diameters of drill ϕ 1.15mm
and copper thickness in hole 25-50 μ m

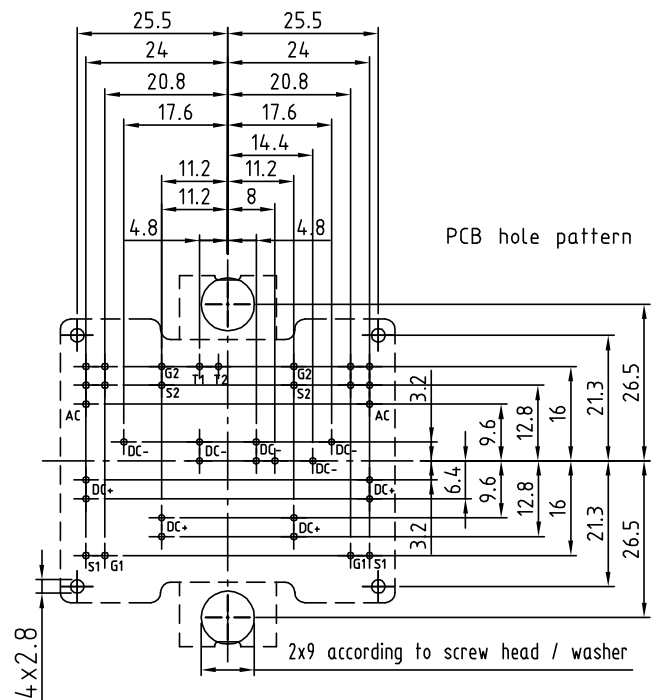

Trademarks

All referenced product or service names and trademarks are the property of their respective owners.

Edition 2019-08-01

**Published by
Infineon Technologies AG
81726 München, Germany**

**© 2019 Infineon Technologies AG.
All Rights Reserved.**

**Do you have a question about this document?
Email: erratum@infineon.com**

WICHTIGER HINWEIS

Die in diesem Dokument enthaltenen Angaben stellen keinesfalls Garantien für die Beschaffenheit oder Eigenschaften des Produktes ("Beschaffenheitsgarantie") dar. Für Beispiele, Hinweise oder typische Werte, die in diesem Dokument enthalten sind, und/oder Angaben, die sich auf die Anwendung des Produktes beziehen, ist jegliche Gewährleistung und Haftung von Infineon Technologies ausgeschlossen, einschließlich, ohne hierauf beschränkt zu sein, die Gewähr dafür, dass kein geistiges Eigentum Dritter verletzt ist.

Des Weiteren stehen sämtliche, in diesem Dokument enthaltenen Informationen, unter dem Vorbehalt der Einhaltung der in diesem Dokument festgelegten Verpflichtungen des Kunden sowie aller im Hinblick auf das Produkt des Kunden sowie die Nutzung des Infineon Produktes in den Anwendungen des Kunden anwendbaren gesetzlichen Anforderungen, Normen und Standards durch den Kunden.

Die in diesem Dokument enthaltenen Daten sind ausschließlich für technisch geschultes Fachpersonal bestimmt. Die Beurteilung der Eignung dieses Produktes für die beabsichtigte Anwendung sowie die Beurteilung der Vollständigkeit der in diesem Dokument enthaltenen Produktdaten für diese Anwendung obliegt den technischen Fachabteilungen des Kunden.

Sollten Sie von uns weitere Informationen im Zusammenhang mit dem Produkt, der Technologie, Lieferbedingungen bzw. Preisen benötigen, wenden Sie sich bitte an das nächste Vertriebsbüro von Infineon Technologies (www.infineon.com).

WARNHINWEIS

Aufgrund der technischen Anforderungen können Produkte gesundheitsgefährdende Substanzen enthalten. Bei Fragen zu den in diesem Produkt enthaltenen Substanzen, setzen Sie sich bitte mit dem nächsten Vertriebsbüro von Infineon Technologies in Verbindung.

Sofern Infineon Technologies nicht ausdrücklich in einem schriftlichen, von vertretungsberechtigten Infineon Mitarbeitern unterzeichneten Dokument zugestimmt hat, dürfen Produkte von Infineon Technologies nicht in Anwendungen eingesetzt werden, in welchen vernünftigerweise erwartet werden kann, dass ein Fehler des Produktes oder die Folgen der Nutzung des Produktes zu Personenverletzungen führen.

IMPORTANT NOTICE

The information given in this document shall in no event be regarded as a guarantee of conditions or characteristics ("Beschaffenheitsgarantie"). With respect to any examples, hints or any typical values stated herein and/or any information regarding the application of the product, Infineon Technologies hereby disclaims any and all warranties and liabilities of any kind, including without limitation warranties of non-infringement of intellectual property rights of any third party.

In addition, any information given in this document is subject to customer's compliance with its obligations stated in this document and any applicable legal requirements, norms and standards concerning customer's products and any use of the product of Infineon Technologies in customer's applications.

The data contained in this document is exclusively intended for technically trained staff. It is the responsibility of customer's technical departments to evaluate the suitability of the product for the intended application and the completeness of the product information given in this document with respect to such application.

For further information on the product, technology, delivery terms and conditions and prices please contact your nearest Infineon Technologies office (www.infineon.com).

WARNINGS

Due to technical requirements products may contain dangerous substances. For information on the types in question please contact your nearest Infineon Technologies office.

Except as otherwise explicitly approved by Infineon Technologies in a written document signed by authorized representatives of Infineon Technologies, Infineon Technologies' products may not be used in any applications where a failure of the product or any consequences of the use thereof can reasonably be expected to result in personal injury.

Mouser Electronics

Authorized Distributor

Click to View Pricing, Inventory, Delivery & Lifecycle Information:

[Infineon:](#)

[FF8MR12W2M1PB11BPSA1](#)