

### DESCRIPTION

The EVM3510A-QV-00A is an evaluation board for MPM3510A, a synchronous rectified, step-down Mini-Module regulator with built-in power MOSFETS, inductor and two capacitors.

The Evaluation Board can deliver a 1.2A continuous output current with excellent load and line regulation over a wide input supply range.

Full protection features include over-current protection and thermal shut down.

The MPM3510A is available in a space-saving QFN-19 (3mmx5mmx1.6mm) package.

### ELECTRICAL SPECIFICATION

Parameter	Symbol	Value	Units
Input Voltage	$V_{IN}$	4.5-36	V
Output Voltage	$V_{OUT}$	3.3	V
Output Current	$I_{OUT}$	1.2	A

### FEATURES

- Complete Switch Mode Power Supply
- 4.5V-to-36V Wide Operating Input Range
- 1.2A Continuous Load Current
- Low  $R_{DS(ON)}$  Internal Power MOSFETS
- Fixed 1.15MHz Switching Frequency
- 800kHz-2MHz Frequency Sync
- Power Save Mode for Light Load
- Power Good Indicator
- OCP Protection with Valley Current detection and Hiccup
- Thermal Shutdown
- Output Adjustable from 0.8V
- Available in QFN-19 (3x5x1.6mm) Package

### APPLICATIONS

- Industrial Controls
- Automotive
- Medical and Imaging Equipment
- Telecom Applications
- LDO Replacement
- Space and Resource-limited Applications
- Distributed Power Systems

All MPS parts are lead-free, halogen free, and adhere to the RoHS directive. For MPS green status, please visit MPS website under Quality Assurance. "MPS" and "The Future of Analog IC Technology" are Registered Trademarks of Monolithic Power Systems, Inc.

## EVM3510A-QV-00A EVALUTION BOARD

(L x W x H) 6.35cm x 6.35cm x 0.3cm

Board Number	MPS IC Number
EVM3510A-QV-00A	MPM3510AGQV

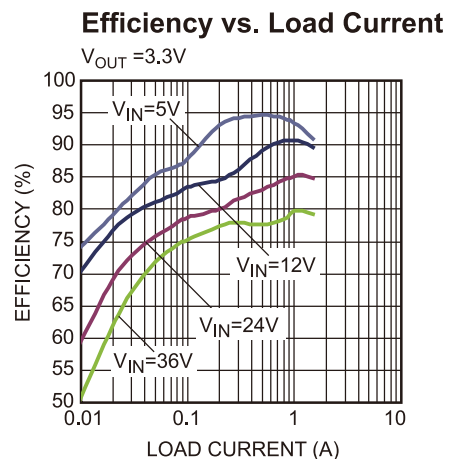

## EVALUATION BOARD SCHEMATIC

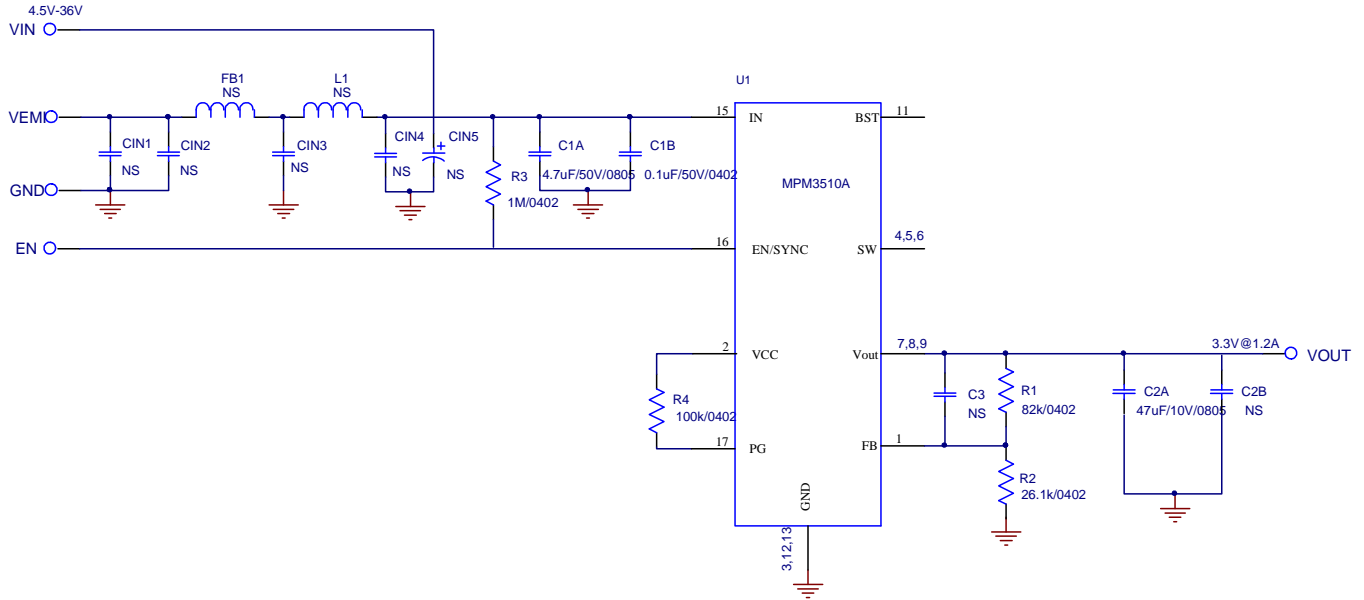

## EVM3510A-QV-00A BILL OF MATERIALS

Qty	RefDes	Value	Description	Package	Manufacturer	Manufacturer_P/N
1	C1A	4.7uF	Ceramic Cap., 50V, X7R	0805	muRata	GRM21BC71H475KE1
1	C1B	0.1uF	Ceramic Cap., 50V, X7R	0402	TDK	C1005X7R1C104K
1	C2A	47uF	Ceramic Cap., 10V, X5R	0805	muRata	GRM21BR61A476ME15L
7	C2B, CIN1, CIN2, CIN3, CIN4, CIN5, C3	NS				
1	R1	82k	Film Res., 1%	0402	Yageo	RC0402FR-0782KL
1	R2	26.1k	Film Res., 1%	0402	Yageo	RC0402FR-0726K1L
1	R3	1M	Film Res., 5%	0402	Yageo	RC0402JR-071ML
1	R4	100k	Film Res., 1%	0402	Yageo	RC0402FR-07100KL
1	FB1	NS				
1	L1	NS				
1	U1		module		MPS	MPM3510A

## EVB TEST RESULTS

Performance waveforms are tested on the evaluation board.

$V_{IN} = 24V$ ,  $V_{OUT} = 3.3V$ ,  $T_A = 25^\circ C$ , unless otherwise noted.

### Output Ripple

$I_{OUT} = 0A$

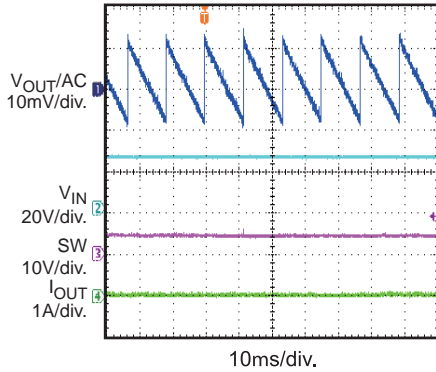

### Output Ripple

$I_{OUT} = 1.2A$

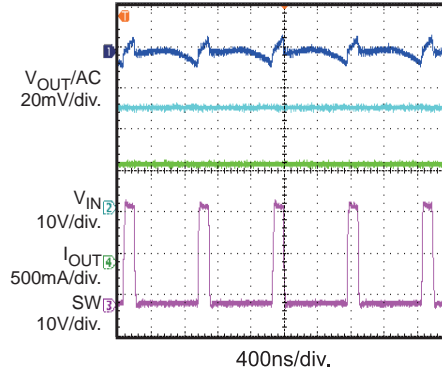

### $V_{IN}$ Startup

$I_{OUT} = 0A$

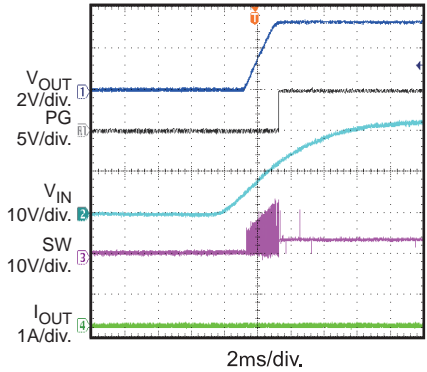

### $V_{IN}$ Startup

$I_{OUT} = 1.2A$

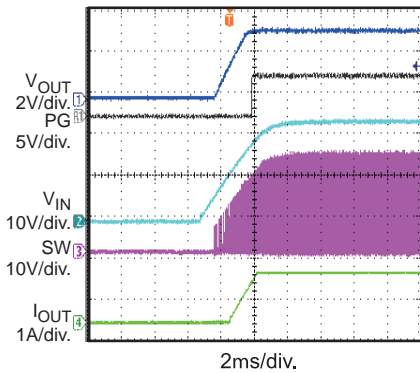

### $V_{IN}$ Shutdown

$I_{OUT} = 0A$

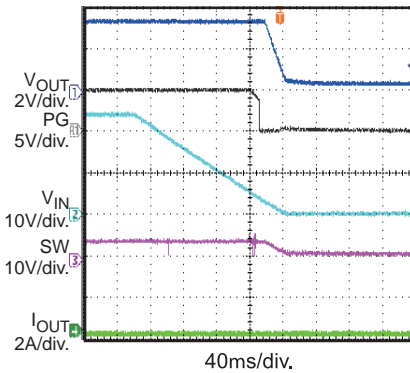

### $V_{IN}$ Shutdown

$I_{OUT} = 1.2A$

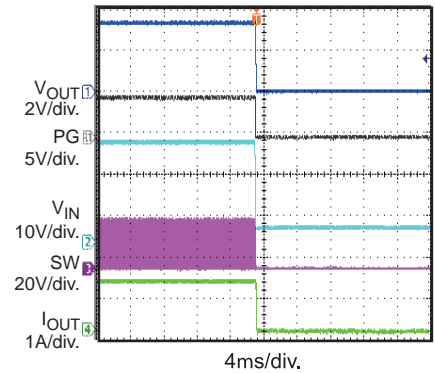

### EN Startup

$I_{OUT} = 0A$

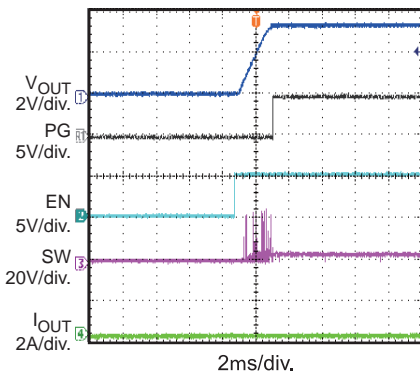

### EN Startup

$I_{OUT} = 1.2A$

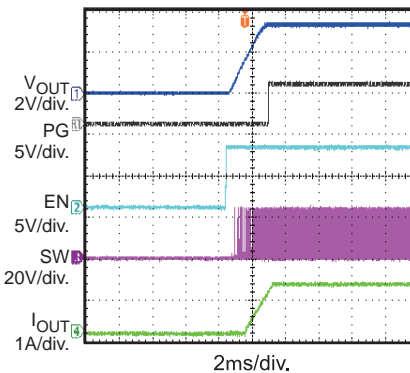

### EN Shutdown

$I_{OUT} = 0A$

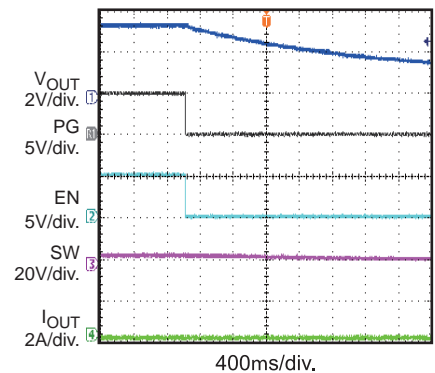

## EVB TEST RESULTS

Performance waveforms are tested on the evaluation board.

$V_{IN} = 24V$ ,  $V_{OUT} = 3.3V$ ,  $T_A = 25^\circ C$ , unless otherwise noted.

**EN Shutdown**

$I_{OUT} = 1.2A$

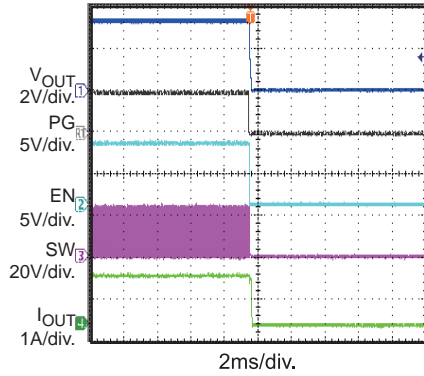

**Load Transient**

$I_{OUT} = 0A-1.2A$

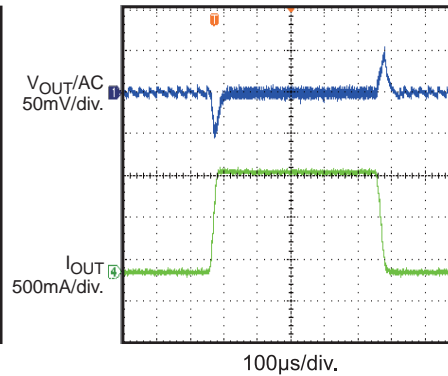

**SCP Steady State**

$I_{OUT} = 0A$

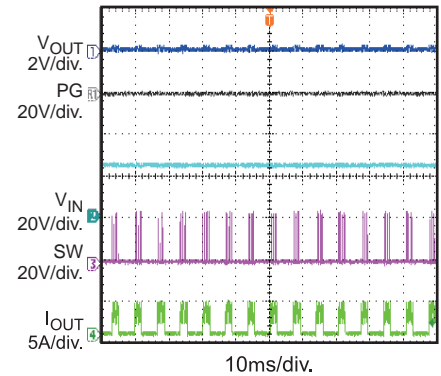

**SCP Entry**

$I_{OUT} = 0A$

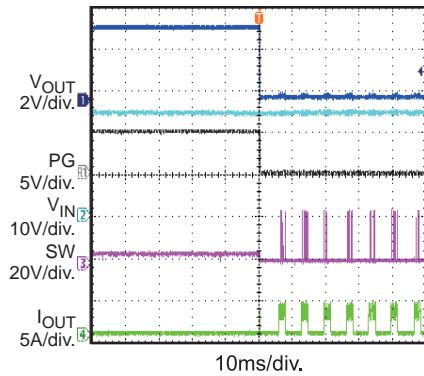

**SCP Recovery**

$I_{OUT} = 0A$

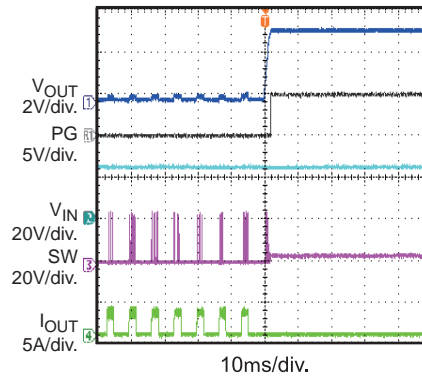

### PRINTED CIRCUIT BOARD LAYOUT

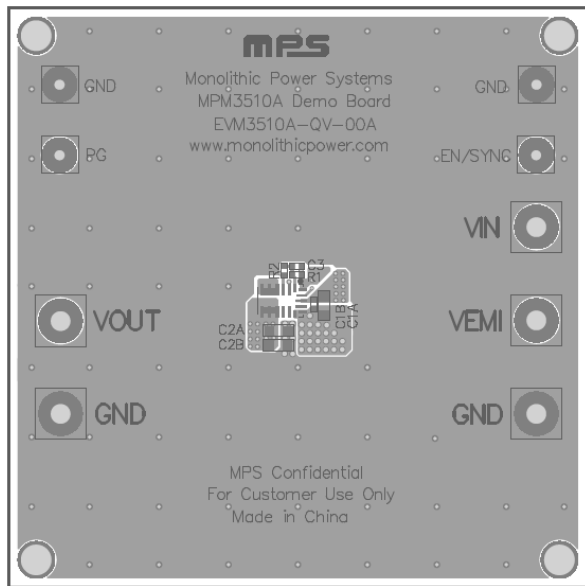

Figure 1-Top Silk Layer & Top layer

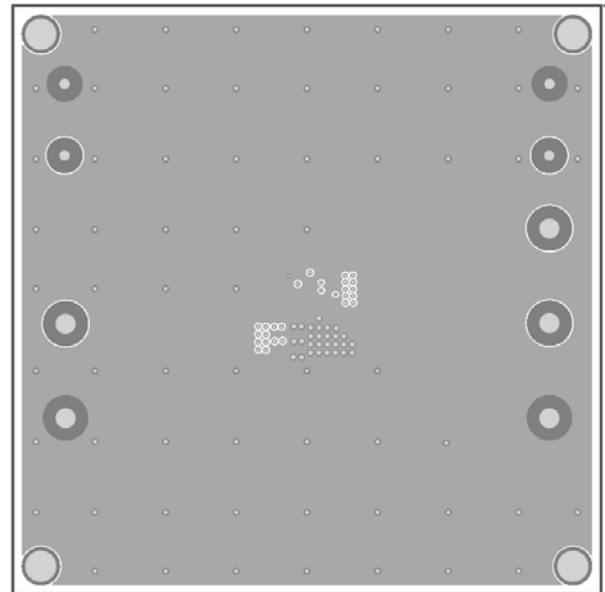

Figure 2-IN1 Layer

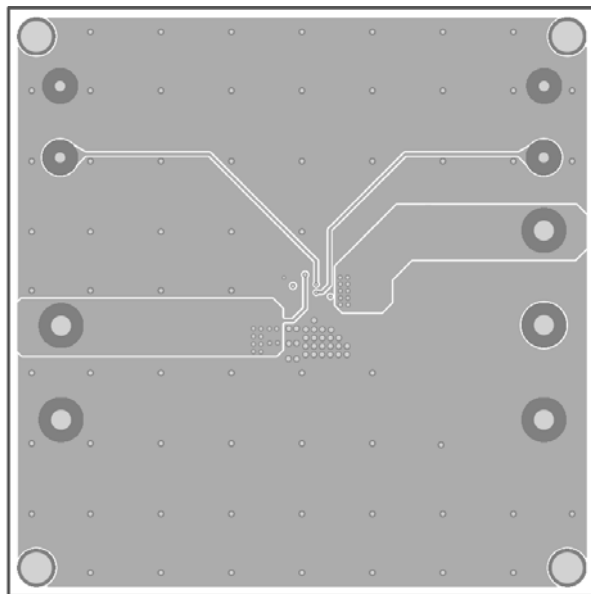

Figure 3-IN2 Layer

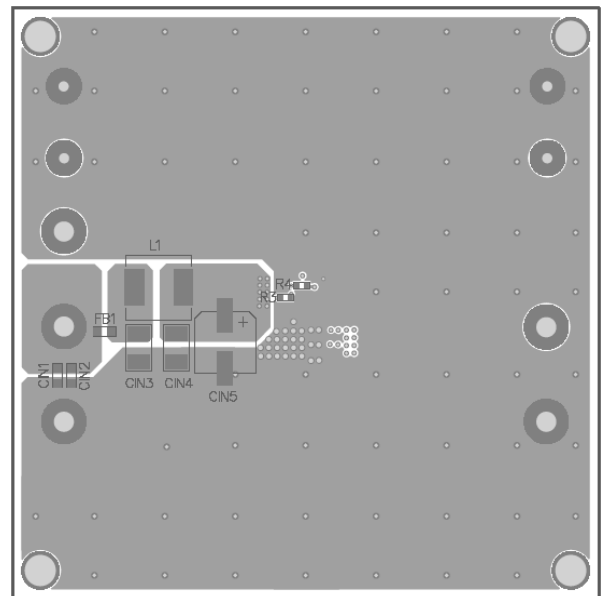

Figure 4-Bottom Silk Layer & Bottom Layer

## QUICK START GUIDE

1. Connect the positive and negative terminals of the load to the VOUT and GND pins, respectively.
2. Preset the power supply output between 4.5V and 36V, and then turn off the power supply.
3. Connect the positive and negative terminals of the power supply output to the VIN and GND pins, respectively.
4. Turn the power supply on. The board will automatically start up.
5. To get better EMI performance, add the EMI components at bottom layer of the board and connect the input power supply between VEMI and GND.
6. To use the SYNC function, connect an external clock with a range of 800kHz to 2MHz to synchronize the internal clock rising edge to the external clock rising edge.

**NOTICE:** The information in this document is subject to change without notice. Users should warrant and guarantee that third party Intellectual Property rights are not infringed upon when integrating MPS products into any application. MPS will not assume any legal responsibility for any said applications.

# Mouser Electronics

Authorized Distributor

Click to View Pricing, Inventory, Delivery & Lifecycle Information:

[Monolithic Power Systems \(MPS\):](#)

[EVM3510A-QV-00A](#)