

For a sustainable connected future.

The right solutions for
smart cities, industry 4.0,
automotive, wearables,
smart homes, mobility,
and healthcare.

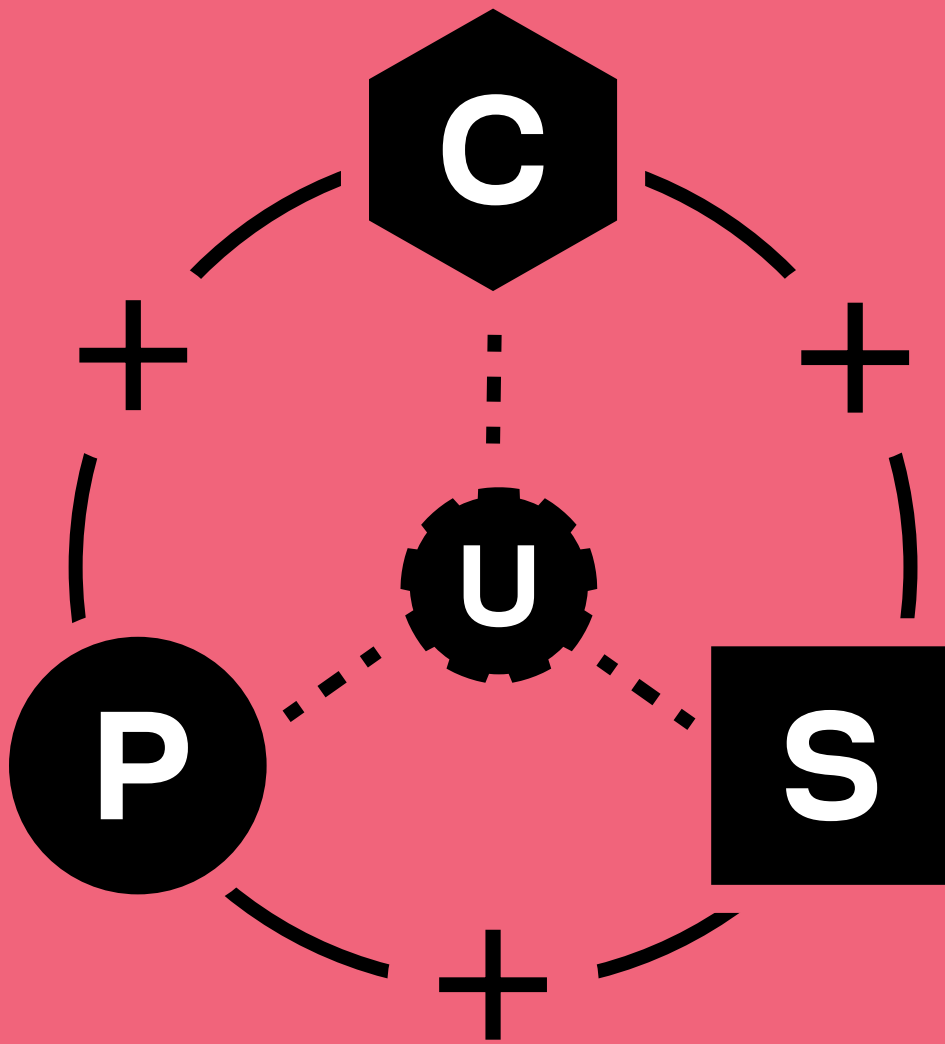



Product Categories



Cellular

We offer a wide range of high-quality, scalable cellular modules perfectly suited for the automotive, industrial and consumer markets with demanding size, cost and quality requirements. Standards like GSM/GPRS, UMTS/HSPA, NB-IoT, LTE-M, LTE Cat 1 and high Cat LTE fulfill the communication needs of specialized areas including goods tracking, fleet management, telematics, industrial monitoring, connected health, security & surveillance, emergency call systems, smart parking, smart lighting, metering and wearables.



Short Range Radio

Our short range radio modules provide communication using Bluetooth®, Wi-Fi, and NFC technologies, or V2X technology for communication between vehicles and roadside infrastructures. Best-in-class performance, close integration with our range of cellular modules and global certification make them the ideal choice for integrators.



Positioning

Our positioning portfolio includes chips, SiPs, modules and antennas that deliver fast, accurate and reliable GNSS positioning, as well as high precision GNSS, precision timing, dead reckoning solutions, and correction services. Applications making use of these highly integrated components include fleet tracking, automotive navigation, mobile communication, agriculture, marine, unmanned vehicles, wearable trackers and construction industries.



Services & evaluation tools

We provide additional services to our GNSS and wireless products that are designed to optimize the product speed, accuracy, and capabilities.



u-blox at a glance

u-blox (SIX:UBXN) is a global provider of leading positioning and wireless communication technologies for the automotive, industrial, and consumer markets. Our solutions let people, vehicles, and machines determine their precise position and communicate wirelessly over cellular and short range networks. With a broad portfolio of chips, modules, and a growing ecosystem of product supporting data services, u-blox is uniquely positioned to empower our customers to develop innovative solutions for the Internet of Things, quickly and cost effectively.

Global presence

Our direct presence in 19 countries ensures that we can react quickly to changing customer demands. It also puts us in a very strong position to share knowledge and market requirements with our customers. u-blox has its headquarters in Thalwil, Switzerland, and is globally present with offices and R&D centers in Europe, Asia and the USA.

We support our customers from component evaluation and selection right through to product design, final production set-up, logistics and after-sales support.

Key facts

Foundation	Founded in 1997, Switzerland
Stock exchange	Listed on the SIX Swiss Exchange (UBXN)
Employees	Over 1'000
Revenue	2018: CHF 393.3 million; 2019 first half-year: CHF 190.6 million
Markets served	Automotive, industrial and consumer
Market penetration	More than 6'700 customers worldwide benefit from our solutions More than 10'000 types of devices rely on our products More than 100'000'000 people and machines utilize our technology

CONTENT

6	Cellular modules and chips
8	NB-IoT and LTE-M
16	4G: LTE Cat 1
22	4G: LTE Cat 4 and LTE Cat 6
30	3G: UMTS/HSPA(+)
34	2G: GSM/GPRS
38	Multiband chipset
40	Short range radio modules and chips
42	Stand-alone: Bluetooth®
66	Stand-alone: Multiradio and Wi-Fi
74	Host-based: Multiradio and Wi-Fi
82	V2X chips and modules
86	Position and time modules
88	High precision & DR GNSS modules: F9 platform
98	High precision & DR GNSS modules: M8 platform
106	Standard precision GNSS SiPs and modules
128	Timing modules
135	Antennas and antenna modules
140	Positioning chips
142	Standard precision GNSS chips
150	Dead Reckoning GNSS chips
152	Previous generation products
154	Services
156	Assisted GNSS
158	CellLocate®
160	Evaluation tools and software
161	Application boards and evaluation kits
164	u-center
165	Android solution
166	m-center
167	RIL software for cellular modules
168	s-center
169	Bluetooth iOS and Android App
170	Contacts & worldwide presence

NEW PRODUCTS

SARA-R5 series
SARA-R4 series with
Secure Cloud
UBX-R5 chip

NINA-B4 series
BMD-380 module
BMD-30/35 series
BMD-34 series
BMD-330 module
BMD-360 module
R41Z module
JODY-W2 series

ZED-F9K module
ZED-F9R module
ZED-F9H module
NEO-D9S series
NEO-M9N module
UBX-M9140 chip

Cellular





Cellular modules		
Series	Package/dimensions	Type of module
SARA	96-pin LGA 16.0 x 26.0 mm	Small, scalable, low-power GSM/GPRS, UMTS, NB-IoT, and LTE-M modules
LARA	100-pin LGA 24.0 x 26.0 mm	Compact LTE Cat 1 modules
LISA	76-pin LCC 22.4 x 33.2 mm	Universal UMTS/HSPA(+) modules
TOBY	152-pin / 248-pin LGA 24.8 x 35.6 mm	LTE Cat 1 modules and high-speed LTE Cat 4 and Cat 6 modules
MPCI	52-pin PCI Express Full-Mini Card Type F2 30 x 51 mm	Powerful LTE modules in industry-standard Mini PCIe package

Nested GSM/UMTS/LPWA/LTE designs

When designing cellular modem products that need to accommodate GSM, UMTS, LPWA, or LTE variants as well as region-specific versions requiring different frequency bands, PCB layout issues can generate a long list of expensive design and logistic problems.

The best way to avoid this issue is simple: layout compatibility across the entire range of cellular modules. With this solution, a single PCB layout can be designed for use by all end-product variations.

This is why u-blox has maintained form-factor compatibility throughout its GSM/GPRS (SARA), UMTS/HSPA/ (LISA/SARA), NB-IoT/LTE-M (SARA), and LTE (TOBY/LARA) cellular module families.

To facilitate nested designs, u-blox provides application notes and PCB reference designs with schematics, Gerber files and bill of materials for 1.8 V and 3.0 V systems.

Example of 2G/3G/4G layout compatibility:

u-blox nested design accommodates these form factors and technologies on the same footprint: SARA GSM/UMTS/NB-IoT/LTE-M, LARA LTE, and TOBY LTE.

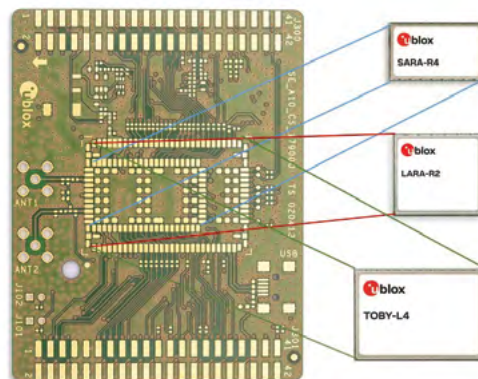

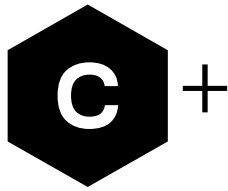

SARA-R5 series

Multi-band LTE-M / NB-IoT modules

Designed to last an IoT lifetime: 5G-ready with the u-blox UBX-R5 chipset

- Built-in end-to-end security with hardware-based Root of Trust inside discrete secure element
- Accurate and reliable positioning, always and everywhere, with u-blox M8 GNSS receiver
- Optimized ultra-low power consumption
- Critical firmware updates delivered and services enabled via uFOTA
- Simplified multi-regional deployments with each hardware variant



Standard



Professional



Automotive

16.0 × 26.0 × 2.5 mm



Product description

The SARA-R5 series is based on u-blox's UBX-R5 cellular chipset and the u-blox M8 GNSS receiver chip. By bringing all technology building blocks in house and having full hardware and software ownership, u-blox can guarantee long-term device availability and provide lifetime support of the entire platform, down to the chipset level.

The modules support a comprehensive set of 3GPP Rel. 14 features that are relevant for IoT applications, like improvements to power consumption, coverage, data rate, mobility and positioning. They are 5G-ready, meaning customers will be able to (software) upgrade their deployed devices, once 5G LTE has been rolled out by mobile operators, greatly improving end product scalability and lifetime.

The SARA-R5 series includes two Secure Cloud variants that support u-blox Common Services Platform (uCSP), making these the ideal choice for devices that transmit critical and confidential information. SARA-R5 Secure Cloud modules benefit from the technology ownership of the entire value chain and combined with an internal, hardware-based, secure element and a lightweight pre-shared key management system that guarantee state-of-the-art security. Thanks to this implementation, the SARA-R5 series offers security-based features and services like local data encryption and decryption, zero touch provisioning, anti-cloning, and secure chip-to-chip communication.

SARA-R510M8 Secure Cloud is pre-integrated with the u-blox M8 GNSS receiver and separate GNSS antenna interface, which provides highly reliable, accurate positioning data in parallel to LTE communication. In addition, the module offers unique hybrid positioning, in which the GNSS position is enhanced with u-blox CellLocate® data, providing location always and everywhere.

SARA-R510 Secure Cloud has been optimized for extremely low power consumption, using less than 1 µA of current in PSM mode, and is ideal for battery-powered applications.

Customers can future-proof their solutions by means of OTA firmware updates, thanks to the uFOTA client/server solution, which utilizes LWM2M, a light and compact protocol ideal for IoT applications.

	SARA-R510 Secure Cloud	SARA-R510M8 Secure Cloud
Grade		
Automotive		
Professional	•	•
Standard		
Regions		
	Multi-region	Multi-region
Access technology		
LTE bands	*	*
Data rate	M1/NB2	M1/NB2
LTE Power class	23 dBm	23 dBm
Positioning		
Integrated GNSS receiver		•
Dedicated GNSS antenna interface		•
Position via modem	•	
AssistNow Software	•	•
CellLocate®	•	•
Interfaces		
UART	2	2
USB (for diagnostics)	1	1
DDC (I2C)	1	1
USIM	1	1
GPIO	6	6
Audio		
Digital audio	□	□
Features		
Security Services: uCSP Ver 1.1	•	•
Root of Trust: secure element	•	•
Antenna dynamic tuning	•	•
CellTime	•	•
Deep sleep mode	•	
Embedded TCP/UDP stack	•	•
Embedded HTTPS, FTPS, TLS	•	•
FW update via serial	•	•
uFOTA	•	•
LWM2M Device Management	•	•
MQTT, MQTT-SN	•	•
CoAP/DTLS	•	•
Last gasp	•	•
Jamming detection	•	•
Antenna and SIM detection	•	•

* = LTE-M/NB-IoT bands: 1, 2, 3, 4, 5, 8, 12, 13, 18, 19, 20, 26, 28
 LTE-M only band: 25
 NB-IoT only bands: 66, 71, 85

□ = Available in future FW version
 NB2 = Cat NB2 (125 kbit/s DL, 140 kbit/s UL)
 M1 = LTE Cat M1 (375 kbit/s DL, 1200 kbit/s UL)

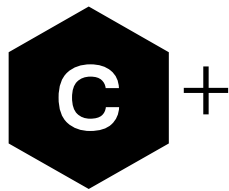

Features

LTE	3GPP Release 13 LTE Cat M1 and NB1 3GPP Release 14 LTE Cat M1: Coverage Enhancement Mode B, Uplink TBS of 2984b 3GPP Release 14 LTE Cat NB2: Higher data rate (TBS of 2536b), Mobility enhancement (RRC connection re-establishment), E-Cell ID, Lower power class PC6 (14 dBm), two HARQ processes, Release Assistant, Random access on Non-Anchor Carrier Cat M1 Half-duplex, 375 kbit/s DL, 1200 kbit/s UL Cat NB2 Half-duplex, 125 kbit/s DL, 140 kbit/s UL
SMS	MT/MO PDU / Text mode SMS over SG/NAS

Software features

Protocols	Dual stack IPv4 and IPv6 PPP over IPv4 and IPv6 Embedded TCP/IP, UDP/IP, FTP, HTTP, DNS Embedded secure MQTT and MQTT-SN Embedded HTTPS, FTPS, TLS Embedded CoAP and DTLS SIM provisioning (BIP)
Security	Root of Trust - Embedded Secure Element EAL5+ High certified Secure boot Secure updates Secure production Anticlone detection & rejection Remote decommissioning Local data encryption and decryption Secure communications (D)TLS Chip-to-Chip (C2C) security Pre-shared keys (PSK) provisioning E2E data encryption and decryption E2E data integrity and authenticity Device automatic enrollment and change of ownership Cloud certificate provisioning Zero touch provisioning for AWS FreeRTOS & IoT device SDK Zero touch provisioning for Azure IoT device SDK
Device Management	LWM2M with Dynamically Loaded Objects
Positioning	Integrated u-blox M8 chip with concurrent GNSS ¹ (GPS, GLONASS, BeiDou, Galileo) Dedicated GNSS antenna interface ¹ Direct access to u-blox GNSS via module ² AssistNow for fastest Time-To-First-Fix CellLocate® & hybrid positioning
Functionalities	Antenna dynamic tuning CellTime for robust and accurate timing reference Last gasp Jamming detection Antenna and SIM detection
Firmware upgrade	Via UART uFOTA client/server solution (Firmware upgrade Over the Air)

1 = On SARA-R510M8 Secure Cloud

2 = On SARA-R510 Secure Cloud

Package

96 pin LGA: 16.0 x 26.0 x 2.5 mm, < 3 g

Environmental data, quality & reliability

Operating temperature	-40 °C to +85 °C
RoHS compliant (lead-free)	
Qualification according to ISO 16750	
Manufactured in ISO/TS 16949 certified production sites	

Certifications and approvals

SARA-R5 series	FCC, ISED, GCF ³ , PTCRB ³ , Verizon ³ , AT&T ³ , T-Mobile ⁴ , Sprint ⁴ , RED, Vodafone ⁴ , Deutsche Telekom ⁴ , KCC ⁴ , SKT ⁴ , Giteki ⁴ , Softbank ⁴ , RCM ⁴ , Telstra ⁴ , ICASA ⁴ , NCC ⁴
----------------	--

3 = for LTE-M only in the 00B firmware version

4 = Planned certifications

Electrical data

Power supply	3.8 V nominal, range 3.0 V to 4.5 V
Power consumption	Power Save Mode: TBD Active Idle Mode: TBD
DRX/eDRX Power consumption	TBD
LTE Cat M1 Connected mode power consumption	TBD
LTE Cat NB2 Connected mode power consumption	TBD

Interfaces

Serial	8-wire UART, configurable as 2x 4-wire UART with ring indication DDC (I2C) USB for diagnostics
GPIO	Up to 6 GPIOs, configurable
(U)SIM	Supports 1.8 V and 3.0 V, SIM toolkit

Support products

EVK-R510S	Evaluation kit for SARA-R510 Secure Cloud
EVK-R510M8S	Evaluation kit for SARA-R510M8 Secure Cloud

Product variants

SARA-R510 Secure Cloud	Ordering code: SARA-R510S-00B Secure Cloud LTE-M and NB-IoT module for multi-regional use
SARA-R510M8 Secure Cloud	Ordering code: SARA-R510M8S-00B Secure Cloud LTE-M and NB-IoT module with integrated u-blox M8 GNSS receiver for multi-regional use

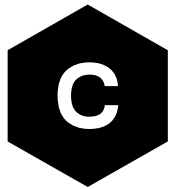

SARA-R4 series

LTE-M/NB-IoT/EGPRS modules with Secure Cloud

Built-in foundation and end-to-end security with Root of Trust

- Always and everywhere location, integrated u-blox M8 GNSS receiver and CellLocate®
- Future-proof solutions via LWM2M with dynamically loaded objects and uFOTA
- Software-based configurability within each hardware design
- Ultra-compact LPWA modules with multi-regional coverage
- Easy migration between u-blox 2G, 3G and 4G modules



Standard



Professional



Automotive

16.0 × 26.0 × 2.5 mm

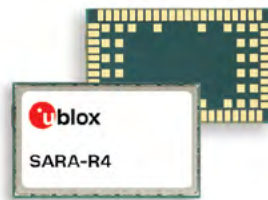

Product description

The SARA-R4 series modules are ideal for mission-critical IoT solutions, as they include a unique and immutable root-of-trust. This provides the foundation for a trusted set of advanced security functionalities. The scalable, pre-shared key management system offers best-in-class data encryption and decryption, both on-device as well as from device-to-cloud. Utilizing the latest (D)TLS stack and cipher suites with hardware-based crypto acceleration provides robust, efficient and protected communication.

SARA-R422M8S is pre-integrated with the u-blox M8 GNSS receiver and separate GNSS antenna interface, which provides highly reliable, accurate positioning data simultaneously with LTE communication. In addition, the module offers unique hybrid positioning, in which the GNSS position is enhanced with u-blox CellLocate® data, providing location always and everywhere.

Customers can future-proof their solutions by means of the uFOTA client/server firmware updates, which utilizes LWM2M, a light and compact protocol ideal for IoT applications. Customized objects and resources can be created and added to devices that are already commercially in the field via the LWM2M dynamically loaded objects functionality.

The ultra-compact 16 x 26 mm LGA modules offer the ability to make software-based configuration decisions for LTE bands, radio interface and system selection preference, as well as Mobile Network Operator within each hardware variant.

With many interface options and an integrated IP stack, the SARA-R4 modules are targeted to a wide range of data-centric IoT applications, such as smart metering, smart lighting, telematics, asset tracking, remote monitoring, alarm panels, and connected health. The SARA-R4 modules target long life, low-maintenance, cost-sensitive, lower power consumption, extended battery life applications.

Thanks to the u-blox nested design principle SARA modules are compatible with other u-blox product families, enabling easy migration from 2G, 3G and 4G. This maximizes the investments of customers, simplifies logistics, and enables very short time-to-market.

	SARA-R410M-63B	SARA-R410M-73B	SARA-R410M-83B	SARA-R422	SARA-R422S	SARA-R422M8S
Grade						
Automotive						
Professional	•	•	•	•	•	•
Standard						
Regions						
	Japan	Korea	Multi	Multi-region		
Access technology						
GSM/EGPRS bands	Q					
LTE bands	1, 8, 19	3, 5, 26	3, 5, 8, 20, 28	1, 2, 3, 4, 5, 8, 12, 13, 20, 25, 26, 28 NB-IoT only: 66, 71, 85		
LTE data rate	M1	M1	M1/NB1	M1/NB2		
LTE power class	23 dBm			23 dBm		
Positioning						
Integrated GNSS receiver	•					
GNSS antenna interface	•					
Position via modem	•	•	•	•		
AssistNow software	•	•	•	•		
CellLocate®	•	•	•	•		
Interfaces						
UART	1	1	1	1	1	1
USB	1	1	1	D	D	D
DDC (I2C)	1	1	1	1	1	1
(U)SIM	1	1	1	1	1	1
GPIO	6	6	6	6	6	6
Audio						
Digital audio					□	□
Features						
Security Root of Trust	•	•	•	•	•	•
Secure Cloud Services	•	•	•	•	•	•
Last gasp	•	•	•	•	•	•
Antenna detection	•	•	•	•	•	•
Embedded TCP/UDP stack	•	•	•	•	•	•
Embedded HTTP, FTP	•	•	•	•	•	•
Embedded HTTPS, FTPS	•	•	•	•	•	•
Embedded TLS, DTLS	•	•	•	•	•	•
Power save mode Rel.12	•	•	•	•	•	•
eDRX	•	•	•	•	•	•
Deep sleep mode	•	•	•	•	•	•
uFOTA	•	•	•	•	•	•
FW update via serial	•	•	•	•	•	•
MQTT	•	•	•	•	•	•
LWM2M device mgmt	•	•	•	•	•	•

M1 = LTE Cat M1 (300 kb/s DL, 375-1200 kb/s UL)
 NB1 = Cat NB1 (27.2 kb/s DL, 62.5 kb/s UL)
 NB2 = Cat NB2 (125 kb/s DL, 140 kb/s UL)

Q = Quad-band
 □ = Available in future FW
 D = for diagnostics



Features

LTE	3GPP Release 13 LTE Cat M1 and NB1¹ Cat M1 half-duplex, 300 kbit/s DL, 375 kbit/s UL Cat NB1 half duplex, 27.2 kb/s DL, 62.5 kb/s UL Coverage enhancement mode A Cat M1 connected mode mobility Rel 12 LTE power save mode, PSM Rel 13 e-DRX 3GPP Release 14 LTE Cat M1 and NB2² NB-IoT Release Assistant Cat M1 half-duplex, 375 kbit/s DL, 1200 kbit/s UL Cat NB2 half-duplex, 125 kbit/s DL, 140 kbit/s UL
GSM	3GPP Release 12 EGPRS MSC12 ²
SMS	MT/MO PDU / text mode SMS over SG/NAS

Security

Foundation	Security Root of Trust Secure boot Secure updates Secure production Anticlone Detection & Rejection
Design	Local authenticated encryption/decryption ³
End-to-end	Secure communication (D)TLS ³ Pre-shared keys (PSK) provisioning ³ E2E data protection ³

Software features

Protocols	Dual stack IPv4 and IPv6 Embedded TCP/IP, UDP/IP, FTP, HTTP Embedded secure MQTT ³ Embedded HTTPS, FTPS, TLS, DTLS ³
Device Management	OMA LWM2M LWM2M with dynamically loaded objects ³
GNSS Interfaces	Integrated u-blox M8 chip with concurrent GNSS (GPS, GLONASS, BeiDou, Galileo) ⁴ Dedicated GNSS antenna interface ⁴ Direct access to u-blox GNSS via module AssistNow software for fastest GNSS TTFF ³ CellLocate & hybrid positioning ³
Firmware upgrade	Via USB ¹ Via UART ² uFOTA client/server solution (Firmware upgrade over the air)

Electrical data

Power supply	3.8 V nominal, range 3.2 V to 4.2 V ¹ 3.8 V nominal, range 3.2 V to 4.5 V ²		
Power consumption	SARA-R41x	SARA-R42x	
	Power save mode:	8 μ A	3 μ A
	Active idle mode:	2 mA	TBD

- 1 = on R41x variants
 2 = on R42x variants
 3 = except for SARA-R422
 4 = on SARA-R422M8S

Package

96 pin LGA: 16.0 x 26.0 x 2.5 mm, < 3 g

Environmental data, quality & reliability

Operating temperature	-40 °C to +85 °C
RoHS compliant (lead-free)	
Qualification according to ISO 16750	
Manufactured in ISO/TS 16949 certified production sites	

Certifications and approvals – planned

SARA-R410M-63B	GITEKI, Softbank, NTT DoCoMo KC, SK Telecom
SARA-R410M-73B	NCC, RCM, RED, Telstra
SARA-R410M-83B	ANATEL, FCC, IFETEL, ISED, NCC, RCM, RED, GCF, PTCRB, AT&T, Deutsche Telekom, T-Mobile USA, Verizon, Vodafone

Interfaces

Serial	1 UART 1 USB 2.0 (high-speed, 480 Mbit/s) ¹ 1 USB, for diagnostics ² 1 DDC (I2C)
GPIO	Up to 6 GPIOs, configurable
(U)SIM	Supports 1.8 V and 3.0 V, SIM toolkit

Support products

EVK-R410M-6	Evaluation kit for SARA-R410M-63B
EVK-R410M-7	Evaluation kit for SARA-R410M-73B
EVK-R410M-8	Evaluation kit for SARA-R410M-83B
EVK-R422	Evaluation kit for SARA-R422
EVK-R422S	Evaluation kit for SARA-R422S
EVK-R422M8S	Evaluation kit for SARA-R422M8S

Product variants

SARA-R410M-63B	Secure Cloud LTE module for Japan. Cat M1 bands: 1, 8, 19
SARA-R410M-73B	Secure Cloud LTE module for Korea. Cat M1 bands: 3, 5, 26
SARA-R410M-83B	Secure Cloud LTE module for multi-regional use. Cat M1, NB1 bands: 3, 5, 8, 20, 28
SARA-R422	LTE-M, NB-IoT and EGPRS module for multi-regional use
SARA-R422S	Secure Cloud LTE-M, NB-IoT and EGPRS module for multi-regional use
SARA-R422M8S	Secure Cloud LTE-M, NB-IoT and EGPRS module with integrated M8 GNSS receiver for multi-regional use



SARA-R4 (x2B) series

Multi-band LTE-M / NB-IoT and EGPRS modules



Standard



Professional



Automotive

Ultra-compact LTE Cat M1 / NB1 and EGPRS modules with multi-regional coverage

- Configurable with a single hardware version
- Flexible mode selection as LTE Cat M1 / LTE Cat NB1 / EGPRS – only/preferred
- Deliver critical firmware updates via uFOTA with LWM2M
- Low power consumption and longer battery life
- Extended range in buildings, basements, and with NB1, underground
- Easy migration between u-blox 2G, 3G and 4G modules

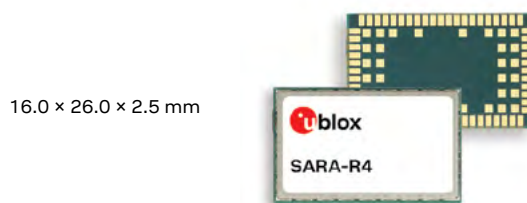

Product description

At 16 x 26 mm, the SARA-R4 (x2B) series modules provide an ultra-compact LTE-M/NB-IoT and EGPRS multi-mode product in a single hardware design. They have software-based LTE band configuration, and come in an LGA package for easy manufacturing.

The SARA-R410M and SARA-R412M variants simplify diverse deployments worldwide and provide enormous operational efficiencies. Software-based configurability of operator profiles and LTE bands enables a wide range of multi-regional coverage. The flexibility extends further through system selection as LTE-M, NB-IoT, EGPRS single or preferred modes. Customers can future-proof their solutions by means of OTA firmware updates, thanks to the uFOTA client/server solution, which utilizes LWM2M, a light and compact protocol ideal for IoT applications. The modules offer low power consumption by utilizing PSM and eDRX, which extend battery life to up to 10 years. Coverage enhancement reaches deeper into buildings and basements (and underground with NB1) with up to 15 dB improved MCL compared to GSM or LTE Cat 1.

With many interface options and an integrated IP stack, the SARA-R4 modules are targeted to a wide range of data-centric IoT applications, such as smart metering, smart lighting, telematics, asset tracking, remote monitoring, alarm panels, and connected health. The SARA-R4 modules target long life, low-maintenance, cost-sensitive, lower power consumption, extended battery life applications.

The SARA form factor follows the u-blox nested design principle and is compatible with other u-blox product families, which facilitates easy migration from 2G, 3G and 4G. This also maximizes the investments of customers, simplifies logistics, and enables very short time-to-market.

The temperature range of -40 to +85 °C guarantees operation in harsh environments. The module is manufactured in ISO/TS 16949 certified sites with the highest production standards, quality and reliability. Each module is fully tested and inspected during production.

	SARA-R410M-52B	SARA-R410M-02B	SARA-R412M-02B
Grade			
Automotive			
Professional	•	•	•
Standard			
Regions			
	North America	Multi-region	Multi-region
Access technology			
GSM/GPRS bands			Q
LTE bands	2, 4, 5, 12, 13	*	*
Data rate	M1	M1/NB	M1/NB
Positioning			
GNSS via modem	•	•	•
AssistNow Software	•	•	•
Interfaces			
UART	1	1	1
USB	1	1	1
DDC (I ² C)	1	1	1
(U)SIM	1	1	1
GPIO	6	6	6
Features			
Last gasp	•	•	•
Antenna detection	•	•	•
Embedded TCP/UDP stack	•	•	•
Embedded HTTPS, FTPS, TLS	•	•	•
Power Save Mode Rel.12	•	•	•
eDRX	•	•	•
Deep sleep mode	•	•	•
FW update via serial	•	•	•
uFOTA	•	•	•
Dual stack IPv4/IPv6	•	•	•
MQTT	•	•	•
LWM2M Device Management	•	•	•

Q = Quad-band
 NB = Cat NB1 (27.2 kb/s DL, 62.5 kb/s UL)
 M1 = LTE Cat M1 (300 kb/s DL, 375 kb/s UL)

* = Bands may include:
 1, 2, 3, 4, 5, 8, 12, 13,
 18, 19, 20, 25, 26, 28



Features

LTE	3GPP Release 13 LTE Cat M1 3GPP Release 13 LTE Cat NB1 Coverage Enhancement Mode A Rel 12 LTE Power Save Mode, PSM Rel 13 e-DRX Cat M1 Half-duplex (300 kbit/s DL, 375 kbit/s UL) Cat NB1 Half-duplex (27.2 kbit/s DL, 62.5 kbit/s UL) Cat NB1 Non-IP Data Delivery
GSM	EGPRS Power Class E2
SMS	MT/MO PDU / Text mode SMS over SG/NAS

Software features

Protocols	Dual stack IPv4 and IPv6 Embedded TCP/IP, UDP/IP, FTP, HTTP Embedded MQTT Embedded HTTPS, FTPS, TLS
Device Management	OMA LWM2M
GNSS Interfaces	Direct access to u-blox GNSS via module AssistNow software for fastest GPS Time-To-First-Fix
Firmware upgrade	Via USB uFOTA client/server solution (Firmware upgrade Over the Air)

Electrical data

Power supply	3.8 V nominal, range 3.2 V to 4.2 V (SARA-R412M has range 3.2 V to 4.5 V)	
Power consumption	Power Save Mode:	8 μ A
	Active Idle Mode:	2 mA
LTE Cat NB1	Min power	60 mA
Connected Mode	0 dBm	65 mA
power consumption	12 dBm	80 mA
	18 dBm	100 mA
	Max power	140 mA
LTE Cat M1	Min power	100 mA
Connected Mode	0 dBm	105 mA
power consumption	12 dBm	125 mA
	18 dBm	150 mA
	Max power	190 mA
2G Connected Mode power consumption	Max power	200 mA

Package

96 pin LGA: 16.0 x 26.0 x 2.5 mm, < 3 g

Environmental data, quality & reliability

Operating temperature	-40 °C to +85 °C
RoHS compliant (lead-free)	
Qualification according to ISO 16750	
Manufactured in ISO/TS 16949 certified production sites	

Certifications and approvals

SARA-R410M-52B	FCC, ISED, PTCRB, AT&T, GCF, Verizon
SARA-R410M-02B	FCC, ISED, NCC, RCM, RED, PTCRB, AT&T, Sprint, Telstra, Telus, Verizon, USCC, GITEKI
SARA-R412M-02B	FCC, ISED, RED, PTCRB, AT&T, T-Mobile USA

Interfaces

Serial	1 UART 1 USB 2.0 (high-speed, 480 Mbit/s) 1 DDC (I ² C)
GPIO	Up to 6 GPIOs, configurable
(U)SIM	Supports 1.8 V and 3.0 V, SIM toolkit

Support products

EVK-R410M-02B	Evaluation kit for SARA-R410M-02B
EVK-R412M-02B	Evaluation kit for SARA-R412M-02B

Product variants

SARA-R410M-52B	LTE module for North America; Cat M1 bands: 2, 4, 5, 12, 13
SARA-R410M-02B	LTE module for multi-regional use; Cat M1/NB1 bands: 1*, 2, 3, 4, 5, 8, 12, 13, 18, 19, 20, 25, 26*, 28
SARA-R412M-02B	LTE, 2G module for multi-regional use; Cat M1/NB1 bands: 2, 3, 4, 5, 8, 12, 13, 20, 26*, 28* EGPRS quad-band, 850/900/1800/1900 MHz

* = Roaming bands



SARA-N3 series

Multi-band NB-IoT modules

Globally configurable NB-IoT modules ready for 3GPP Rel 14 and 5G

- Broad feature set enabling new IoT applications
- Ultra-low power consumption delivering 10+ years battery life
- Critical firmware updates delivered via uFOTA with LwM2M
- Easy migration between u-blox LTE-M and 2G modules
- Professional grade manufacturing (ISO/TS16949); qualified according to ISO 16750

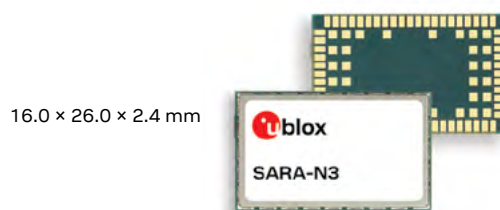

Product description

SARA-N3 NB-IoT multi-band modules support a selected set of features based on 3GPP Release 14. The products will be able to receive additional features and ultimately become Release 14 and 5G compliant via subsequent firmware upgrades.

SARA-N3 modules introduce several new firmware features and internet protocols for NB-IoT products, including TCP, CoAP, DTLS, LwM2M, MQTT, SSL/TLS and HTTP(S). They enable a diverse and broad set of new IoT applications and simplify customer migration to NB-IoT from other legacy cellular or unlicensed technologies. With u-blox nested design, easy migration between u-blox LTE-M, LTE Cat 1 and 2G modules is guaranteed, while enabling future-proof, seamless mechanical scalability across technologies.

SARA-N3 is a power optimized product that delivers 10+ years of battery life on a single cell primary battery, thus reducing maintenance costs. Critical firmware updates can be delivered over the air using the u-blox uFOTA client / server solution with LwM2M, which is a more lightweight solution compared to OMA-DM. LwM2M dynamically configurable objects allow device makers to develop customized features.

The SARA-N3 series is manufactured to professional grade standards with 100% automatic x-ray and optical inspection on modules, as well as 100% outgoing test, product traceability, PCN process, failure analysis and product qualification according to ISO 16750. This level of quality is paramount for highly reliable products intended for long term use in the field.

	SARA-N300	SARA-N310 ^A
Grade		
Automotive		•
Professional	•	•
Standard		
Regions		
	China	Multi-region
Access technology		
LTE bands	3, 5, 8	3, 5, 8, 20, 28, +
Data rate	NB2	NB2
Interfaces		
UART	2	2
USIM	1	1
ADC	2	2
GPIO *	5	5
Features		
Last gasp	•	•
SIM detection	•	•
Antenna detection	•	•
Embedded TCP/UDP stack	•	•
Embedded HTTPS, TLS	•	•
Power Save Mode Rel.12	•	•
eDRX	•	•
Deep sleep mode	•	•
FW update via serial	•	•
FOTA / uFOTA	•	•
Dual stack IPv4/IPv6	•	•
Embedded CoAP/DTLS	•	•
Embedded MQTT-SN	•	•
Embedded MQTT		•
LwM2M device management	•	•
Jamming detection	•	•

* = RTS / CTS can also be configured as general purpose input/output
 A = ATEX variant
 + = LTE Cat NB1 bands 1, 2, 4, 12, 13, 18, 19, 26, 66, 71, 85 available in future FW
 NB2 = Cat NB2 (125 kb/s DL, 140 kb/s UL)



Features

LTE NB-IoT	3GPP Release 13 LTE Cat NB1 fully compliant 3GPP Release 14 LTE Cat NB2 support of: Mobility enhancement, E-Cell ID, larger TB size, two HARQ processes, multi-carrier enhance- ment, single-tone and multi-tone uplink Data rate: up to 125 kbit/s DL, 140 kbit/s UL
FDD bands	Configurable multi-band: SARA-N300: bands 3, 5, 8 SARA-N310: bands 3, 5, 8, 20, 28, (1, 2, 4, 12, 13, 18, 19, 26, 66, 71, 85) ¹
Data transfer	Non-IP based Small Data over NAS (SDoNAS) IP based SDoNAS MT/MO SMS PDU / Text mode
Network	Rel 13 e-DRX Rel 12 LTE Power Save Mode (PSM)

Software features

Protocols	Dual stack IPv4 and IPv6 Embedded TCP/IP, UDP/IP, FTP, HTTP, PPP, DNS Embedded MQTT-SN, CoAP/DTLS Embedded HTTPS, TLS, SSL SARA-N310: MQTT, Radio policy manager SARA-N310: SIM provisioning (BIP)
Device manage- ment	SARA-N310: LwM2M with dynamically loaded objects
Functionalities	Last gasp Antenna detection SIM detection Bluetooth 4.2 (BR/EDR and BLE) ¹ Configurable voltage domain 1.8 V and 3.0 V
IoT platforms	SARA-N300: CTCC Tianyi SARA-N300: CMCC OneNET
Security	Jamming detection
Firmware upgrade	Via UART SARA-N300: FOTA according to CTCC/CMCC SARA-N310: uFOTA client/server solution via LwM2M

Interfaces

Serial	4-wire UART (with flow control) and ring indication for data 2-wire UART for debug
GPIO	Up to 5 GPIOs, configurable (RTS / CTS can also be configured as general purpose input/output.)
ADC	Up to 2 10-bit ADC
USIM	Supports 1.8 V and 3.0 V SARA-N310: SIM toolkit and Bearer Independent Protocol (BIP)

¹ = Considered for future FW version

Package

96 pin LGA: 16.0 x 26.0 x 2.4 mm, < 3 g

Environmental data, quality & reliability

Operating temperature	-40 °C to +85 °C
RoHS compliant (lead-free)	
Qualification according to ISO 16750	
Manufactured in ISO/TS 16949 certified production sites	

Electrical data

Power supply	3.6 V nominal, range 2.6 V to 4.2 V
Power consumption	PSM deep-sleep mode: 3 µA eDRX idle mode: < 1 mA Rx mode: 23 mA Tx mode at maximum power: 250 mA

Certifications and approvals

SARA-N300	CCC, SRRC, CMCC ² , CTCC ² , CUCC ²
SARA-N310	RED, RCM, ATEX/IECEX, GCF, NCC, IMDA, NBTC, Vodafone, Deutsche Telekom

² = Planned certifications

Support products

EVK-N300	Evaluation kit for SARA-N300
EVK-N310	Evaluation kit for SARA-N310

Product variants

SARA-N300	u-blox NB-IoT multi-band module for China
SARA-N310	u-blox NB-IoT multi-band global module

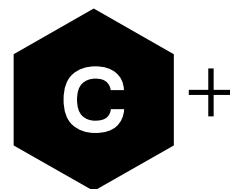

LARA-R3121 module

LTE Cat 1 module using u-blox chipset with built-in GPS receiver



Professional



Automotive



Connectivity, positioning, and timing solution: all in one module

- Provides position data and timing, indoors and outdoors
- Supports versatile protocols for IoT and IIoT applications
- Features device security, transport security, and secure update via uFOTA
- Provides signal optimization and congestion control
- Enables easy migration from other u-blox module form factors and technologies

24.0 × 26.0 × 2.6 mm

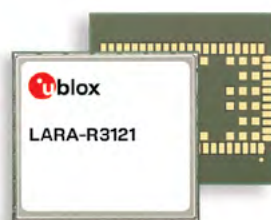

LARA-R3121

Product description

The LARA-R3121 LTE Cat 1 module is a pioneer, as the only module designed from the ground up for IoT applications. At its core is the UBX-R3 chipset, u-blox's own cellular modem with silicon-integrated GPS receiver.

The UBX-R3 platform provides a wide range of features for secure and robust operation, such as secure boot, transport layer security, embedded FOTA client for secure software updates over the air, and jamming detection.

Based on u-blox's innovative software-defined modem engine, LARA-R3121 offers advanced 3GPP features, such as Rel. 12 Power Saving Mode for long battery life, Extended Access Barring (EAB) feature for signaling optimization/ congestion control.

Thanks to the integration of a u-blox 8 GPS receiver directly in the UBX-R3 chipset, LARA-R3 cost-effectively provides highly reliable and accurate positioning data both indoors and outdoors. In addition, LARA-R3121 offers practical hybrid positioning, in which GPS position is enhanced with u-blox CellLocate® location data. Uniquely, it also provides a robust and accurate timing reference, CellTime™, which is obtained from available GPS or LTE base stations, allowing simple and cost efficient implementation of timing solutions.

The LARA-R3121 comes in a compact LGA package with several interfaces and a fully embedded IP stack, making it easy to integrate in size-restricted designs and suitable for a wide range of medium data rate applications.

LARA-R3121 modules are perfectly suited for use in industrial IoT (IIoT) applications, including asset/vehicle tracking, smart meter gateways, mobile digital signage, connected health applications, and low latency applications such as point-of-sale systems. Its data rate enables bi-directional video streaming, as necessary for security and video surveillance.

The LARA form factor enables straightforward migration from u-blox SARA (2G, 3G, and LTE) and TOBY (LTE) modules, maximizing reuse of previous hardware investments. And USB drivers and RIL software for Linux, Android and Microsoft are available free of charge, optimizing time-to-market and product cost.

Grade	
Automotive	
Professional	•
Standard	
Regions	
	APAC
Access technology	
LTE bands	1, 3, 5, 7, 8, 28
Data rate	Cat 1
Positioning	
Integrated u-blox 8 GPS receiver	•
GNSS via modem §	•
AssistNow software	•
CellLocate®	•
Interfaces	
UART	2
USB	1
HSIC	H
DDC (I ² C)	1
SDIO (master)	H
GPIO	10
Features	
Antenna and SIM detection	•
Antenna dynamic tuning	•
CellTime™	•
Secure boot	<input type="checkbox"/>
Embedded TCP/UDP	•
Embedded FTP/HTTP	•
Embedded TLS 1.2	•
Power Save Mode Rel.12	•
FW update via serial	•
uFOTA / FOTA	•
Jamming detection	•
LWM2M device management	•
Rx diversity	•
Last gasp	•
MQTT, MQTT-SN	•
CoAP/DTLS	•

Cat 1 = LTE Cat 1 (10 Mbit/s DL, 5 Mbit/s UL)
§ = external GNSS can be controlled via the modem

H = Hardware-ready
 = Available in future FW version

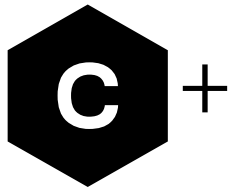

Features

LTE	Cat 1 (10 Mbit/s DL, 5 Mbit/s UL) 3GPP Release 10 Power Saving Mode, Release 12 ¹ Extended Access Barring (EAB) Enhancements
FDD bands	Bands 1, 3, 5, 7, 8, 28 (APAC) All channel bandwidths: 1.4 – 20 MHz Rx diversity
SMS	MT/MO PDU/Text mode SMS over SG/NAS
Network	Status indication via LED
Protocols	Dual stack IPv4 / IPv6 PPP over IPv4 and IPv6 Embedded TCP/IP, UDP/IP Embedded HTTP/HTTPS, FTP/FTPS MQTT and MQTT-SN CoAP SIM provision (BIP)
Security / robustness	Secure boot ¹ Transport layer security (TLS1.2) DTLS uFOTA/FOTA Jamming detection
Device management	LWM2M

Positioning features

GNSS receiver	72-channel u-blox 8 engine GPS/QZSS L1 C/A
Assistance GNSS	AssistNow Online AssistNow Offline OMA SUPL & 3GPP compliant ¹
Acquisition	Cold: 30 s / Aided: 3 s / Reacquisition: 1 s
Max nav. update rate	Up to 10 Hz
CellLocate®	Cell tower location data to supplement positioning receiver data

Interfaces

Serial	8-wire UART (configurable as 2x 4-wire UART with ring indication) 1 USB 2.0 (high-speed, 480 Mbit/s) 1 HSIC ¹ 1 SDIO ¹ 1 DDC (I ² C) Time pulse (via GPIO)
GPIO	Up to 10 configurable GPIOs
USIM	Supports 1.8 V and 3.0 V, SIM toolkit

¹ = Available in future FW version

Package

100 pin LGA (Land Grid Array): 26.0 x 24.0 x 2.6 mm < 4 g

Electrical data

Power supply	3.3 V to 4.4 V
Power consumption	TBD

Environmental data, quality & reliability

Operating temperature	-40 °C to +85 °C (extended range)
RoHS compliant (lead-free)	
REACH compliant	
Manufactured in ISO/TS 16949 certified production sites	

Certifications and approvals

LARA-R3121	GCF, NCC, RCM
------------	---------------

Support products

EVK-R3121	Evaluation kit for LARA-R3121
RIL software	Available for Android
USB driver	Available for Windows 10 (standard and IoT), Windows 7, 8

Product variants

LARA-R3121	LTE Cat 1, Bands 1, 3, 5, 7, 8, 28 (APAC)
------------	---



LARA-R2 series

Single or multi-mode LTE Cat 1 modules with positioning capability

Region-specific LTE Cat 1 modules with 2G or 3G fallback

- Voice support via VoLTE or CSFB
- Cellular location service and hybrid positioning
- Small, compact LARA LGA form factor for easy manufacturing
- Easy migration between u-blox 2G, 3G and 4G modules



Standard



Professional



Automotive

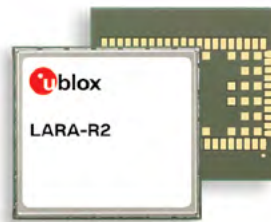

24.0 × 26.0 × 2.6 mm

Product description

LARA-R2 series modules support multi-band LTE-FDD with six regional variants. Each variant is designed for specific regional market requirements to allow development of cost-efficient yet feature-rich products. The variants with 2G or 3G fallback provide connectivity in cases where LTE coverage is not yet available. This allows seamless operation during technology transition.

With many interface options and an integrated IP stack, the modules are designed to support a wide range of data-and-voice-centric applications. The unique combination of performance, security and flexibility make them ideal for medium speed M2M applications, such as smart energy gateways, remote access video cameras, digital signage, telehealth and telematics.

LARA-R2 modules support Voice over LTE (VoLTE) or CSFB voice service for applications such as security and surveillance systems.

Thanks to u-blox's CellLocate® technology, LARA-R2 offers cost-effective location estimation based on information from surrounding cellular base stations. A positioning solution with CellLocate and a u-blox GNSS module provides redundancy and accuracy that can be beneficial for numerous applications. The temperature range of -40 °C to +85 °C guarantees operation in harsh environments and in very compact designs. The ultra-compact LGA package enables straightforward automated manufacturing. The LARA form factor follows the u-blox nested design principle in order to maintain design compatibility between modules supporting different cellular technologies. It is compatible with the SARA, LISA and TOBY module families. This allow customers to easily upgrade their products or develop new variants using the same footprint, thus maximizing investments, simplifying logistics, and enabling a very short time-to-market.

LARA-R2 modules are manufactured in ISO/TS 16949 certified sites, with the highest production standards and the highest quality and reliability. Each module is fully tested and inspected during production. Modules are qualified according to ISO 16750 – for systems installed in vehicles.

USB drivers and RIL software for Android are free of charge.

	LARA-R202	LARA-R203	LARA-R204	LARA-R211	LARA-R220	LARA-R280
Grade						
Automotive						
Professional	•	•	•	•	•	•
Standard						
Regions						
	North America	North America	North America	Europe	Japan	APAC
Access technology						
GSM/GPRS bands	D1					
UMTS/HSPA [MHz]	850, 1900					2100
LTE bands	2, 4, 5, 12	2, 4, 12	4, 13	3, 7, 20	1, 19	3, 8, 28
Data rate	Cat 1	Cat 1	Cat 1	Cat 1	Cat 1	Cat 1
Positioning						
GNSS via modem §	•	•	□	•	•	•
AssistNow software	•	•	□	•	•	•
CellLocate®	•	•	□	•	•	•
Interfaces						
UART	1	1	1	2	1	1
USB	1	1	1	1	1	1
HSIC	H	H	H	H	H	H
DDC (I2C)	1	1	1	1	1	1
SDIO (master)	H	H	H	H	H	H
GPIO	9	9	9	9	9	9
Audio						
Digital audio	1	1		1		1
Features						
VoLTE	v	v		•		c
Antenna detection	•	•	•	•	•	•
Embedded TCP/UDP	•	•	•	•	•	•
Embedded FTP/HTTP	•	•	•	•	•	•
Embedded TLS 1.2	•	•	•	•	•	•
FW update via serial	•	•	•	•	•	•
FOTA	•	•	•	•	•	•
Rx diversity	•	•	•	•	•	•
Dual stack IPv4/IPv6	•	•	•	•	•	•

Cat 1 = LTE Cat 1 (10 Mb/s DL, 5 Mb/s UL)

§ = external GNSS can be controlled via the modem

D1 = Dual-band 900/1800 MHz

v = VoLTE available and AT&T certified

□ = Available in future FW

H = Hardware-ready

c = CSFB only



Features

LTE	<p>Cat 1 (10 Mbit/s DL, 5 Mbit/s UL) 3GPP Release 9 FDD bands:</p> <ul style="list-style-type: none"> - LARA-R202: 2, 4, 5, 12 (N. America) - LARA-R203: 2, 4, 12 (N. America) - LARA-R204: 4, 13 (N. America) - LARA-R211: 3, 7, 20 (Europe) - LARA-R220: 1, 19 (Japan) - LARA-R280: 3, 8, 28 (APAC) <p>All channel bandwidths: 1.4 - 20 MHz Rx diversity Power saving mode for low power consumption</p>
UMTS	<p>HSDPA category 8, HSUPA category 6 Bands (in MHz):</p> <ul style="list-style-type: none"> - LARA-R202: 850, 1900 - LARA-R280: 2100
GSM	<p>GPRS/EDGE multi-slot class 33 Bands (in MHz):</p> <ul style="list-style-type: none"> - LARA-R211: E-GSM 900 / DCS 1800
SMS	<p>MT/MO PDU/Text mode SMS over IMS and via SMS-C</p>
Voice	<p>VoLTE or CSFB Codec: HR/FR/EFR/AMR/AMR-WB Echo cancelation & noise reduction</p>

Software features

Protocols	<p>Dual stack IPv4 / IPv6 Embedded TCP/IP, UDP/IP HTTP/HTTPS, FTP/FTPS eSIM and Bearer Independent Protocol</p>
GNSS Interfaces	<p>Direct access to u-blox M8 via LARA-R2 AssistNow software for fastest GNSS Time-To-First-Fix CellLocate® & hybrid positioning</p>
Firmware upgrade	<p>Via UART and USB FOTA (firmware upgrade over the air)</p>

Interfaces

Serial	<p>1 UART (LARA-R211 supports 2 x UART) 1 USB 2.0 (high-speed, 480 Mbit/s) 1 HSIC ¹ 1 SDIO ¹ 1 DDC (I2C)</p>
GPIO	Up to 9 configurable GPIOs
(U)SIM	Supports 1.8 V and 3.0 V, SIM toolkit
Audio	1 digital

Electrical data

Power supply	<p>3.8 V nominal, range 3.3 V to 4.4 V Extended range 3.0 V to 4.5 V Extended range 2.8 V to 4.5 V (LARA-R211)</p>
--------------	--

Package

100 pin LGA (Land Grid Array): 24.0 x 26.0 x 2.6 mm, < 4 g

Environmental data, quality & reliability

Operating temperature -40 °C to +85 °C (extended range)
RoHS compliant (lead-free)
Qualification according to ISO 16750
Manufactured in ISO/TS 16949 certified production sites

Security

Transport Layer Security (TLS 1.2)
Jamming detection ¹

¹ = Available in future FW version

Certifications and approvals

LARA-R202-02B	PTCRB, FCC, ISED, AT&T ² , T-Mobile, Rogers, Telus
LARA-R202-82B	PTCRB, FCC, ISED, AT&T ² , US. Cellular, T-Mobile
LARA-R203	PTCRB, FCC, ISED, AT&T ² , T-Mobile, Rogers
LARA-R204	GCF, FCC, ISED, Verizon
LARA-R211	GCF, RED, Vodafone
LARA-R220	Giteki, NTT docomo
LARA-R280	NCC, RCM

² = VoLTE is available and AT&T certified

Support products

EVK-R2	Evaluation kits for LARA-R2 series
RIL software	Available for Android 9.0 and previous versions
USB driver	Available for Windows 7, 8, 10 and for Embedded Windows 7.x, 8.x, 10.x

Product variants

LARA-R202-02B	LTE Cat 1 module with 3G fallback for N. America. LTE bands 2, 4, 5, 12
LARA-R202-82B	LTE Cat 1 module with 3G fallback for N. America. LTE bands 2, 4, 5, 12
LARA-R203	LTE Cat 1 module for North America. LTE bands 2, 4, 12
LARA-R204	LTE Cat 1 module for North America. LTE bands 4, 13
LARA-R211	LTE Cat 1 module with 2G fallback for Europe. LTE bands 3, 7, 20
LARA-R220	LTE Cat 1 module for Japan /NTT docomo. LTE bands 1, 19
LARA-R280	LTE Cat 1 module with 3G fallback for APAC. LTE bands 3, 8, 28



TOBY-R2 series

Multi-mode LTE Cat 1 modules with positioning capability

Global LTE Cat 1 modules with 2G and 3G fallback

- LTE bands for global coverage (TOBY-R200-82B)
- Voice support via VoLTE or CSFB
- Cellular location service and hybrid positioning
- The separate power supply on TOBY-R200 extends its battery life
- Easy migration between u-blox 2G, 3G, and 4G modules



Standard



Professional



Automotive

24.8 × 35.6 × 2.6 mm

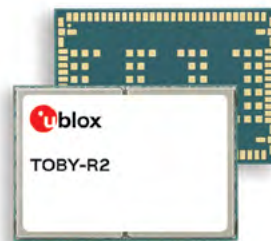

Product description

The TOBY-R2 module series supports multi-band LTE-FDD along with 3G (UMTS) and 2G (GSM) fallback in a very small LGA package.

The modules are ideal for applications requiring global coverage, and especially those that are transitioning to LTE from 2G and 3G, due to the long term availability and scalability of LTE networks. At the same time in areas with marginal LTE coverage, they also provide global 2G and 3G fallback.

With a range of interface options and an integrated IP stack, the module is designed to support a wide range of data-centric applications. The unique combination of performance, flexibility, and global coverage make the module ideally suited for medium speed M2M applications, such as smart energy gateways, remote access video cameras, digital signage, telehealth and telematics.

When power saving mode is enabled, it reduces energy consumption and allows battery-powered modules a longer operation time.

The temperature range of -40 °C to +85 °C guarantees operation in harsh environments and in very compact designs.

It supports Voice over LTE (VoLTE) and 3G voice service (CSFB) for applications where voice is required, such as in security and surveillance systems. Transport Layer Security (TLS) provides privacy and data integrity.

The compact LGA package enables straightforward automated manufacturing. Easy migration from u-blox GSM/GPRS, CDMA, and UMTS/HSPA maximizes the investments of customers, simplifies logistics, and enables very short time-to-market.

TOBY-R2 modules are manufactured in ISO/TS 16949 certified sites, with the highest production standards and the highest quality and reliability. Each module is fully tested and inspected during production. Modules are qualified according to ISO 16750 – for systems installed in vehicles.

USB drivers and RIL software for Android are free of charge.

	TOBY-R200-02B	TOBY-R200-82B	TOBY-R202
Grade			
Automotive			
Professional	•	•	•
Standard			
Regions			
	North America	Global	North America
Access technology			
GSM/GPRS bands	Q	Q	
UMTS/HSPA [MHz]	850, 900, 1900, 2100	850, 900, 1900, 2100	850, 1900
LTE bands	2, 4, 5, 12	1, 2, 4, 5, 8, 12	2, 4, 5, 12
Data rate	Cat 1	Cat 1	Cat 1
Positioning			
GNSS via modem §	•	•	•
AssistNow Software	•	•	•
CellLocate®	•	•	•
Interfaces			
UART	1	1	1
USB	1	1	1
DDC (I2C)	1	1	1
SDIO (master)	H	H	H
GPIO	9	9	9
Audio			
Digital audio	1	1	1
Features			
VoLTE	v	v	v
Antenna detection	•	•	•
Embedded TCP/UDP	•	•	•
Embedded FTP/HTTP	•	•	•
Embedded TLS 1.2	•	•	•
FW update via serial	•	•	•
FOTA	•	•	•
Rx diversity	•	•	•
Dual stack IPv4/IPv6	•	•	•

v = VoLTE available and AT&T certified
 § = external GNSS can be controlled via modem

Cat 1 = LTE Cat 1
 (10 Mb/s DL, 5 Mb/s UL)
 H = Hardware-ready



Features

LTE	Cat 1 (10 Mbit/s DL, 5 Mbit/s UL) 3GPP Release 9 FDD bands: – TOBY-R200-02B: 2, 4, 5, 12 – TOBY-R200-82B: 1, 2, 4, 5, 8, 12 – TOBY-R202: 2, 4, 5, 12 All channel bandwidths: 1.4 - 20 MHz Rx Diversity
UMTS	HSDPA category 8, HSUPA category 6 Bands (in MHz): – TOBY-R200-02B: 850, 900, 1900, 2100 – TOBY-R200-82B: 850, 900, 1900, 2100 – TOBY-R202: 850, 1900 Rx Diversity
GSM	GPRS/EDGE multi-slot class 12 Bands (in MHz): – TOBY-R200-02B: quad band – TOBY-R200-82B: quad band
SMS	MT/MO PDU/Text mode SMS over IMS and via SMS-C
Voice	VoLTE or CSFB Codec: HR/FR/EFR/AMR/AMR-WB Echo cancelation & noise reduction

Software features

Protocols	Dual stack IPv4 / IPv6 Embedded TCP/IP, UDP/IP HTTP/FTP/SSL (Secure Socket Layer) eSIM and Bearer Independent Protocol
GNSS Interfaces	Direct access to u-blox M8 via TOBY-R2 AssistNow software for fastest GNSS Time-To-First-Fix CellLocate® & Hybrid Positioning
Firmware upgrade	Via UART and USB FOTA (Firmware upgrade over the air)

Interfaces

Serial	1 UART 1 USB 2.0 (high-speed, 480 Mbit/s) 1 I2C 1 SDIO ¹
GPIO	Up to 9 configurable GPIOs
(U)SIM	Supports 1.8 V and 3 V, SIM toolkit
Audio	1 digital

Package

152 pin LGA (Land Grid Array): 24.8 x 35.6 x 2.6 mm, < 5 g

Electrical data

Power supply 3.8 V nominal, range 3.3 V to 4.4 V
Extended range 3.0 V to 4.5 V

Environmental data, quality & reliability

Operating temperature –40 °C to +85 °C (extended range)

RoHS compliant (lead-free)

Qualification according to ISO 16750

Manufactured in ISO/TS 16949 certified production sites

Security

Transport Layer Security (TLS 1.2)

Jamming detection¹

¹ = Available in future FW version

Certifications and approvals

TOBY-R200-02B	PTCRB, FCC, RED, ISED, AT&T ² , T-Mobile
TOBY-R200-82B	PTCRB, FCC, RED, ISED, AT&T ² , U.S. Cellular, T-Mobile
TOBY-R202	PTCRB, FCC, ISED, AT&T ² , U.S. Cellular, T-Mobile

² = VoLTE is available and AT&T certified

Support products

EVK-R200	Evaluation Kit for TOBY-R200
EVK-R202	Evaluation Kit for TOBY-R202
RIL software	Available for Android 9.0 and previous versions
USB driver	Available for Windows 7, 8, 10 and for Embedded Windows 7.x, 8.x, 10.x

Product variants

TOBY-R200-02B	LTE Cat 1 module with global 2G and 3G fallback LTE bands 2, 4, 5, 12
TOBY-R200-82B	Global LTE Cat 1 module with 2G and 3G fallback LTE bands 1, 2, 4, 5, 8, 12
TOBY-R202	LTE Cat 1 module with 3G fallback LTE bands 2, 4, 5, 12



TOBY-L4 uCPU series

LTE Advanced (Cat 6) modules with uCPU Linux app programming

Most powerful application CPU in the industry

- uCPU embedded Linux application programming capability with 19000 DMIPS total processing power
- Very comprehensive set of interfaces including RGMII/RMII and analog audio
- Pre-integrated u-blox GNSS and Wi-Fi components
- Temperature range -40 °C to +85 °C, with eCall setup up to +95 °C
- State of the art security implementation



Standard



Professional



Automotive

24.8 × 35.6 × 2.6 mm

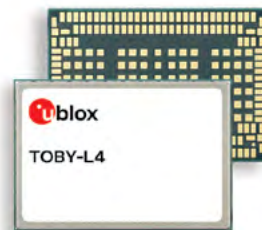

TOBY-L4006-01
TOBY-L4106-01
TOBY-L4206-01
TOBY-L4906-01

Product description

The TOBY-L4 series supports LTE Cat 6 TDD, LTE Cat 6 FDD, UMTS and GSM connectivity in a compact LGA package. Developers can host their applications directly in the module in a configurable Linux OS, enabling customers to save the cost of an external CPU, memory and peripherals in order to optimize the total cost. Customer application development in a standard Linux/Yocto environment based on HW virtualization benefits from the flexible open source Linux community. The extremely powerful embedded CPU has 19000 DMIPS, allowing the development of complex and demanding applications, such as Cat 6 Wi-Fi hot spotting and in-car telephony. With no processor bottleneck, the application can be scaled up as needed. The module comes with an extremely comprehensive set of HW interfaces (including RGMII/RMII for Ethernet and analog audio) so that applications do not need expensive external components, such as serial to Ethernet bridges or audio codecs.

With 3GPP Rel. 10 and LTE Cat 6 supporting carrier aggregation, which provides data throughput up to 300 Mbit/s, the modules are the perfect choice for applications requiring the highest data rates.

The -40 °C to +85 °C temperature range supports the establishment of an eCall at +95 °C for at least 2 minutes. Complemented by a set of state-of-the art security features, TOBY-L4 modules are the ideal product for the development of all kinds of automotive devices, such as smart antennas and in-dash telematics/infotainment devices.

TOBY-L4 modules are manufactured in ISO/TS 16949 certified sites, with the highest production standards and the highest quality and reliability. Each module is fully tested and inspected during production. Modules are qualified according to ISO 16750 – for systems installed in vehicles.

	TOBY-L4006-01	TOBY-L4106-01	TOBY-L4206-01	TOBY-L4906-01
Grade				
Automotive	•	•	•	•
Professional				
Standard				
Regions				
	N. America	EMEA	APAC/Brazil	China
Access technology				
GSM/GPRS bands	D2	D1	Q	D1
UMTS/HSPA [MHz]	850, 1700, 1900	900, 2100	850, 900, 2100	900, 2100
LTE FDD bands	2, 4, 5, 7, 12, 13, 29	1, 3, 7, 8, 20	1, 3, 5, 7, 8, 9, 19, 28	1, 3
LTE TDD bands		38		39, 40, 41
Data rate	Cat 6	Cat 6	Cat 6	Cat 6
Positioning				
GNSS via modem §	•	•	•	•
AssistNow Software	<input type="checkbox"/>	<input type="checkbox"/>	<input type="checkbox"/>	<input type="checkbox"/>
CellLocate®	<input type="checkbox"/>	<input type="checkbox"/>	<input type="checkbox"/>	<input type="checkbox"/>
Interfaces				
UART	4	4	4	4
USB	1*	1*	1*	1*
DDC (I ² C)	2	2	2	2
SDIO (Master)	1	1	1	1
RGMII/RMII	1	1	1	1
GPIO	14	14	14	14
Audio				
Analog audio	1	1	1	1
Digital audio	1	1	1	1
Features				
Antenna detection	•	•	•	•
Jamming detection	•	•	•	•
Embedded TCP/UDP	•	•	•	•
Embedded FTP/HTTP	•	•	•	•
Embedded TLS 1.2	•	•	•	•
FW update via USB	•	•	•	•
FOTA	•	•	•	•
Rx diversity	•	•	•	•
Dual stack IPv4/IPv6	•	•	•	•
MIMO 2x2	•	•	•	•

D1 = Dual-band 900/1800 MHz
D2 = Dual-band 850/1900 MHz
Q = Quad-band
 = Available in future FW

Cat 6 = 300 Mb/s download, 50 Mb/s upload
* = USB used for tracing and firmware update
§ = external GNSS can be controlled via the modem



Features

LTE	Cat 6 (300 Mbit/s DL, 50 Mbit/s UL) 3GPP Release 10 FDD and TDD bands: – TOBY-L4006: 2, 4, 5, 7, 12, 13, 29 (N. America) – TOBY-L4106: 1, 3, 7, 8, 20, 38 (EMEA) – TOBY-L4206: 1, 3, 5, 7, 8, 9, 19, 28 (APAC/Brazil) – TOBY-L4906: 1, 3, 39, 40, 41 (China) Carrier aggregation All channel bandwidths: 1.4 - 20 MHz MIMO 2x2, Rx diversity
UMTS/DC-HSPA+	Bands: – TOBY-L4006: 2, 4, 5 (N. America) – TOBY-L4106: 1, 8 (EMEA) – TOBY-L4206: 1, 5, 8 (APAC/Brazil) – TOBY-L4906: 1, 8 (China) 42 Mbit/s downlink, 5.76 Mbit/s uplink
GSM	Bands: – TOBY-L4006: 2, 5 (N. America) – TOBY-L4106: 3, 8 (EMEA) – TOBY-L4206: 2, 3, 5, 8 (APAC/Brazil) – TOBY-L4906: 3, 8 (China) GPRS & EDGE Class 33
SMS	MT/MO PDU / Text mode SMS over IMS and via SMS-C
Voice	VoLTE and CSFB Codec: HR/FR/EFR/AMR/AMR-WB Echo cancelation & noise reduction

Software features

uCPU embedding programming (Linux/Yocto) Full modem / customer application separation through HW virtualization	
Protocols	Dual stack IPv4 / IPv6 Embedded TCP/IP, UDP/IP HTTP/FTP/SSL (Secure Socket Layer) eSIM and Bearer Independent Protocol
Network	Jamming detection
eCall / ERA Glonass SW pre-integration of GNSS and Wi-Fi AssistNow software for fastest Time-To-First-Fix ¹ CellLocate® & Hybrid Positioning ¹	
Firmware upgrade	Via USB Via FOTA

Security features

Secure boot and secure update	
Crypto HW accelerator / true random number generator	
Secure debugging	
Secure file system	
Secure services provided by dedicated Security Virtual Machine / Trusted Execution Environment	

¹ = Available in future firmware

Package

248-pin LGA (Land Grid Array): 24.8 x 35.6 x 2.6 mm, 4.8 g

Electrical data

Power supply 3.8 V nominal, range 3.3 V to 4.4 V

Environmental data, quality & reliability

Operating temperature –40 °C to +85 °C (extended range)
eCall at +95 °C for at least 2 minutes

RoHS compliant (lead-free)

Automotive qualification

Manufactured in ISO-TS 16949 certified production sites

Planned certifications and approvals

TOBY-L4006-01	FCC, ISED (formerly known as IC), PTCRB, GCF, AT&T
TOBY-L4106-01	RED (formerly known as R&TTE), GCF
TOBY-L4206-01	PTCRB, GCF, Anatel
TOBY-L4906-01	CCC

Contact your nearest u-blox office for a full list of certifications.

Interfaces

Serial	4 UART (1 can be configured to SPI) 1 USB 3.0/2.0 1 SDIO (Wi-Fi interface) 1 SPI 1 RGMII / RMII 2 I ² C / DDC
GPIO ²	Up to 14 GPIOs, configurable
Audio	1 digital and 1 analog
(U)SIM	2 SIM supporting 1.8 V and 3 V, SIM toolkit
Other	1 4-bit MMC (eMMC/SD memory) 2 ADC

² = Other interfaces can be configured as GPIO if primary function not used

Support products

EVK-L4x Evaluation kits for TOBY-L4 series

Product variants

TOBY-L4006-01	LTE Cat 6 FDD / DC-HSPA+ / GSM modules for North America; LTE bands 2, 4, 5, 7, 12, 13, 29
TOBY-L4106-01	LTE Cat 6 FDD and TDD / DC-HSPA+ / GSM modules for Europe, Asia; LTE bands 1, 3, 7, 8, 20, 38
TOBY-L4206-01	LTE Cat 6 FDD / DC-HSPA+ / GSM modules for APAC; LTE bands 1, 3, 5, 7, 8, 9, 19, 28
TOBY-L4906-01	LTE Cat 6 FDD and TDD / DC-HSPA+ / GSM modules for China; LTE bands 1, 3, 39, 40, 41



TOBY-L4 slim modem series

LTE Advanced (Cat 6) modules with HSPA+ and 2G fallback

Best in class data rate with LTE Cat 6 and Carrier Aggregation support

- 300 Mbit/s DL peak data rate
- Global coverage with 4 variants
- AECQ certified cellular chipset
- Automotive grade, qualified according to ISO 16750
- Temperature range -40 °C to + 85 °C, with eCall setup up to +95 °C



Standard



Professional



Automotive

24.8 × 35.6 × 2.6 mm

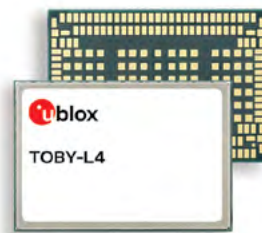

Product description

The TOBY-L4 slim modem series supports LTE-TDD, LTE-FDD, UMTS and GSM connectivity in a compact LGA package. These slim modem TOBY-L4 variants have been designed to be connected with an external application (typically running Linux or Android OS) via AT commands in order to provide the highest data rate and best user experience.

With 3GPP Rel. 10 and LTE Cat 6 supporting carrier aggregation, which provides data throughput up to 300 Mbit/s, the modules are the perfect choice for vehicle infotainment systems, ruggedized mobile terminals, set top boxes, notebooks, tablets, as well as high-speed M2M applications such as digital signage, mobile health, remote security and video systems.

The modules support VoLTE and Circuit-Switched-Fall-Back voice, and they guarantee HSPA+ and GSM connectivity, also in areas that do not yet have LTE coverage.

The TOBY-L4 series supports a temperature range of -40 °C to +85 °C and enables the establishment of eCall at +95 °C for at least 2 minutes.

TOBY-L4 modules are manufactured in an ISO/TS 16949 certified site, with the highest production standards and the highest quality and reliability. Each module is fully tested and inspected during production. Modules are qualified according to ISO 16750 – for systems installed in vehicles.

	TOBY-L4006-51	TOBY-L4106-51	TOBY-L4206-51	TOBY-L4906-51
Grade				
Automotive	•	•	•	•
Professional				
Standard				
Regions				
	N. America	EMEA	APAC/Brazil	China
Access technology				
GSM/GPRS bands	D2	D1	Q	D1
UMTS/HSPA [MHz]	850, 1700, 1900	900, 2100	850, 900, 2100	900, 2100
LTE FDD bands	2, 4, 5, 7, 12, 13, 29	1, 3, 7, 8, 20	1, 3, 5, 7, 8, 9, 19, 28	1, 3
LTE TDD bands	38			39, 40, 41
Data rate	Cat 6	Cat 6	Cat 6	Cat 6
Positioning				
GNSS via modem §	<input type="checkbox"/>	<input type="checkbox"/>	<input type="checkbox"/>	<input type="checkbox"/>
AssistNow Software	<input type="checkbox"/>	<input type="checkbox"/>	<input type="checkbox"/>	<input type="checkbox"/>
CellLocate®	<input type="checkbox"/>	<input type="checkbox"/>	<input type="checkbox"/>	<input type="checkbox"/>
Interfaces				
USB	1	1	1	1
DDC (I ² C)	1	1	1	1
RGMII/RMII	1	1	1	1
GPIO	9	9	9	9
Audio				
Analog audio	1	1	1	1
Digital audio	1	1	1	1
Features				
Antenna detection	•	•	•	•
Jamming detection	•	•	•	•
FW update via USB	•	•	•	•
FOTA	•	•	•	•
Rx diversity	•	•	•	•
Dual stack IPv4/IPv6	•	•	•	•
MIMO 2x2	•	•	•	•

D1 = Dual-band 900/1800 MHz

D2 = Dual-band 850/1900 MHz

Q = Quad-band

□ = Available in future FW

Cat 6 = 300 Mb/s download, 50 Mb/s upload

§ = external GNSS can be controlled via the modem

TOBY-L4 slim modem series



Features

LTE Advanced	Cat 6 (300 Mbit/s DL, 50 Mbit/s UL) 3GPP Release 10 FDD and TDD bands: – TOBY-L4006: 2, 4, 5, 7, 12, 13, 29 (N. America) – TOBY-L4106: 1, 3, 7, 8, 20, 38 (EMEA) – TOBY-L4206: 1, 3, 5, 7, 8, 9, 19, 28 (APAC/Brazil) – TOBY-L4906: 1, 3, 39, 40, 41 (China) Carrier aggregation All channel bandwidths: 1.4 - 20 MHz MIMO 2x2, Rx diversity
UMTS/DC-HSPA+	Bands: – TOBY-L4006: 2, 4, 5 (N. America) – TOBY-L4106: 1, 8 (EMEA) – TOBY-L4206: 1, 5, 8 (APAC/Brazil) – TOBY-L4906: 1, 8 (China) 42 Mbit/s downlink, 5.76 Mbit/s uplink
GSM	Bands: – TOBY-L4006: 2, 5 (N. America) – TOBY-L4106: 3, 8 (EMEA) – TOBY-L4206: 2, 3, 5, 8 (APAC/Brazil) – TOBY-L4906: 3, 8 (China) GPRS & EDGE Class 33
SMS	MT/MO PDU / Text mode SMS over IMS and via SMS-C
Voice	VoLTE ¹ and CSFB Codec: HR/FR/EFR/AMR/AMR-WB Echo cancelation & noise reduction

Software features

3GPP AT commands + u-blox extensions	
Protocols	Dual stack IPv4 / IPv6 eSIM and Bearer Independent Protocol
Network	Jamming detection eCall / ERA Glonass
GNSS Interfaces	SW pre-integration of GNSS and Wi-Fi ¹ AssistNow software for fastest Time-To-First-Fix ¹ CellLocate® & Hybrid Positioning ¹
Firmware upgrade	Via USB Via FOTA

Interfaces

Serial	1 USB 1 RGMII / RMII 1 DDC (I ² C)
GPIO ²	Up to 9 GPIOs, configurable
Audio	1 digital and 1 analog
(U)SIM	2 SIM supporting 1.8 V and 3.0 V, SIM toolkit

¹ Available in future firmware

Package

248-pin LGA (Land Grid Array): 24.8 x 35.6 x 2.6 mm, 4.8 g

Electrical data

Power supply 3.8 V nominal, range 3.3 V to 4.4 V

Environmental data, quality & reliability

Operating temperature –40 °C to +85 °C (extended range)
eCall at +95 °C for at least 2 minutes

RoHS compliant (lead-free)

Automotive qualification

Manufactured in ISO/TS 16949 certified production sites

Planned certifications and approvals

TOBY-L4006-51A	FCC, ISED (formerly known as IC), PTCRB, GCF, AT&T
TOBY-L4106-51A	RED (formerly known as R&TTE), GCF
TOBY-L4206-51A	PTCRB, GCF, Anatel ²
TOBY-L4906-51A	CCC

Contact your nearest u-blox office for a full list of certifications.
2 = Planned

Support products

EVK-L4x	Evaluation kits for TOBY-L4 series
Linux modem manager	
Android RIL	
USB drivers for Windows 7, 8, 10	

Product variants

TOBY-L4006-51	LTE Cat 6 FDD / DC-HSPA+ / GSM modules for North America; LTE bands 2, 4, 5, 7, 12, 13, 29
TOBY-L4106-51	LTE Cat 6 FDD and TDD / DC-HSPA+ / GSM modules for Europe, Asia; LTE bands 1, 3, 7, 8, 20, 38
TOBY-L4206-51	LTE Cat 6 FDD / DC-HSPA+ / GSM modules for APAC; LTE bands 1, 3, 5, 7, 8, 9, 19, 28
TOBY-L4906-51	LTE Cat 6 FDD and TDD / DC-HSPA+ / GSM modules for China; LTE bands 1, 3, 39, 40, 41



TOBY-L2 series

Multi-mode LTE Cat 4 modules with HSPA+ and/or 2G fallback

Simple integration with the ELLA-W131 Wi-Fi module

- Compact TOBY LGA form factor for easy manufacturing
- Easy migration between u-blox 2G, 3G and 4G modules
- Automotive grade available, qualified according to ISO 16750
- Deliver critical firmware updates over the air
- TOBY-L201 switches automatically between AT&T and Verizon



Standard



Professional



Automotive

24.8 × 35.6 × 2.6 mm

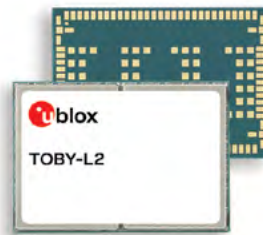

Product description

TOBY-L2 series modules support multi-band LTE-FDD, along with DC-HSPA+ and EGPRS in a very small LGA package.

With 3GPP Rel. 9 and LTE Cat 4, which provides data throughput up to 150 Mbit/s, the modules are ideal for both industrial and consumer applications requiring the highest data-rates.

They are the perfect choice for vehicle infotainment systems, ruggedized mobile terminals, set top boxes, notebooks, tablets, as well as high-speed M2M applications such as digital signage, mobile health, remote security and video systems where backwards compatibility with 3G and 2G networks is desired.

The modules support Circuit-Switched-Fall-Back voice. They guarantee HSPA+ connectivity, also in areas that do not yet have LTE coverage.

The temperature range from -40 °C to +85 °C guarantees operation in harsh environments and in very compact designs. The TOBY-L201 works on AT&T and Verizon networks and can switch between the operators, based on the SIM card used or via an AT command.

The compact LGA package enables straightforward automated manufacturing. Easy migration from u-blox UMTS, CDMA, and GSM modules maximizes the investments of customers, simplify logistics, and implies a very short time-to-market.

TOBY-L2 modules are manufactured in ISO/TS 16949 certified sites, with the highest production standards and the highest quality and reliability. Each module is fully tested and inspected during production. Modules are qualified according to ISO 16750 – for systems installed in vehicles.

USB drivers and RIL software for Android are free of charge.

	TOBY-L200	TOBY-L201	TOBY-L210	TOBY-L220	TOBY-L280
Grade					
Automotive	•		•		•
Professional	•	•	•	•	•
Standard					
Regions					
	North America	North America	EMEA/ APAC	Japan	S. America/ APAC
Access technology					
GSM/GPRS bands	Q		Q		Q
UMTS/HSPA [MHz]	850, 900, 1700, 1900, 2100	850, 1900	850, 900, 1900, 2100	850, 900, 2100	850, 900, 1900, 2100
LTE FDD bands	2, 4, 5, 7, 17	2, 4, 5, 13, 17	1, 3, 5, 7, 8, 20	1, 3, 5, 8, 19	1, 3, 5, 7, 8, 28
Data rate	Cat 4	Cat 4	Cat 4	Cat 4	Cat 4
Interfaces					
UART	1	1	1	1	1
USB	1	1	1	1	1
DDC (I ² C)	1		1	1	1
SDIO (Master)	1	1	1	1	1
GPIO	14	14	14	14	14
Audio					
Digital audio	1		1	1	1
Features					
Network indication	•	•	•	•	•
Antenna detection	•	•	•	•	•
Embedded TCP/UDP	•	•	•	•	•
Embedded FTP/HTTP	•	•	•	•	•
Embedded TLS 1.2	•	•	•	•	•
FW update via serial	•	•	•	•	•
FOTA	•	•	•	•	•
Rx diversity	•	•	•	•	•
Dual stack IPv4/IPv6	•	•	•	•	•
MIMO 2x2	•	•	•	•	•

Q = Quad-band

Cat 4 = LTE Cat 4 (150 Mb/s download, 50 Mb/s upload)



Features

LTE	Cat 4 (150 Mbit/s DL, 50 Mbit/s UL) 3GPP Release 9 FDD Bands: – TOBY-L200: 2, 4, 5, 7, 17 (N. America) – TOBY-L201: 2, 4, 5, 13, 17 (N. America) – TOBY-L210: 1, 3, 5, 7, 8, 20 (EMEA/APAC) – TOBY-L220: 1, 3, 5, 8, 19 (Japan) – TOBY-L280: 1, 3, 5, 7, 8, 28 (S. America/APAC) All channel bandwidths: 1.4 - 20 MHz MIMO 2x2 Rx diversity
UMTS/DC-HSPA+	Bands (in MHz): – TOBY-L200: 850/900/1700/1900/2100 – TOBY-L201: 850/1900 – TOBY-L210: 850/900/1900/2100 – TOBY-L220: 850/900/2100 – TOBY-L280: 850/900/1900/2100 42 Mbit/s downlink, 5.76 Mbit/s uplink
GSM	Bands (in MHz): – TOBY-L200: 850/900/1800/1900 – TOBY-L210: 850/900/1800/1900 – TOBY-L280: 850/900/1800/1900 GPRS & EDGE Class 12
SMS	MT/MO PDU / Text mode SMS over IMS and via SMS-C
Voice	CSFB Codec: HR/FR/EFR/AMR/AMR-WB Echo cancelation & noise reduction

Software features

Protocols	Dual stack IPv4 / IPv6 Embedded TCP/IP, UDP/IP HTTP/FTP/SSL (Secure Socket Layer) eSIM and Bearer Independent Protocol
Wi-Fi interface	To ELLA-W1 module
Firmware upgrade	Via UART and USB Via FOTA

Interfaces

Serial	1 UART 1 USB 2.0 (high-speed, 480 Mbit/s) 1 DDC (I ² C) 1 SDIO (Master)
GPIO	Up to 14 GPIOs, configurable
(U)SIM	Supports 1.8 V and 3.0 V, SIM toolkit
Audio	1 digital

Package

152-pin LGA (Land Grid Array): 24.8 x 35.6 x 2.6 mm, 4.8 g

Electrical data

Power supply	3.8 V nominal, range 3.4 V to 4.35 V
Consumption current	Connected mode LTE max power: 610 mA Idle mode: 1.1 mA

Environmental data, quality & reliability

Operating temperature	–40 °C to +85 °C (extended range)
RoHS compliant (lead-free)	
Qualification according to ISO 16750	
Manufactured in ISO/TS 16949 certified production sites	

Certifications and approvals

TOBY-L200	PTCRB, GCF, FCC, ISED (formerly known as IC), RED (formerly known as R&TTE), AT&T, Anatel, Rogers (Canada)
TOBY-L201	PTCRB, GCF, FCC, ISED (formerly known as IC), AT&T, Verizon
TOBY-L210	PTCRB, GCF, FCC, ISED (formerly known as IC), RED (formerly known as R&TTE), RCM (Australia), NCC, KCC (Korea), Giteki (Japan), Softbank (Japan)
TOBY-L220	Giteki (Japan), NTT DoCoMo (Japan)
TOBY-L280	PTCRB, GCF, FCC, ISED (formerly known as IC), RED (formerly known as R&TTE), RCM (Australia), NCC, Anatel (Brazil)

Support products

EVK-L2x	Evaluation Kits for TOBY-L2 series
RIL software	Available for Android
USB driver	Available for Embedded Windows 6.0, 7, 2013 and Windows 7, 8, 8.1, 10

Product variants

TOBY-L200	LTE Cat 4 / DC-HSPA+ / EGPRS modules for North America; LTE bands 2, 4, 5, 7, 17
TOBY-L201	LTE Cat 4 / DC-HSPA+ modules for North America; LTE Bands 2, 4, 5, 13, 17 Ability to switch between operators
TOBY-L210	LTE Cat 4 / DC-HSPA+ / EGPRS modules for EMEA/APAC; LTE bands 1, 3, 5, 7, 8, 20
TOBY-L220	LTE Cat 4 / DC-HSPA+ modules for Japan; LTE bands 1, 3, 5, 8, 19
TOBY-L280	LTE Cat 4 / DC-HSPA+ / EGPRS modules for South America and APAC; LTE bands 1, 3, 5, 7, 8, 28



MPCI-L2 series

Multi-mode LTE Cat 4 Mini PCIe modules with HSPA+ / 2G fallback

TOBY-L2 in MPCI form factor

- Powerful LTE modules in industry-standard Mini PCIe package
- Highest throughput of up to 150 Mbit/s with LTE Cat 4
- Variants for Americas, Europe, and APAC
- Deliver critical firmware updates over the air
- Industrial temperature range -40 °C to +85 °C
- MPCI-L201 switches automatically between AT&T and Verizon



Standard



Professional



Automotive

30.0 × 51.0 × 3.7 mm



Product description

MPCI-L2 series modules support multi-band LTE-FDD, along with DC-HSPA+ and EGPRS.

With 3GPP Rel. 9 and LTE Cat 4, which provides data throughput up to 150 Mbit/s, the modules are ideal for both industrial and consumer applications requiring the highest data rates.

Typical applications are industrial computing, ruggedized terminals, video communication, wireless routers, alarm panels and surveillance, digital signage, and payment systems.

The temperature range of -40 °C to +85 °C guarantees operation in harsh environments, making the modules suitable for industrial applications.

The modules support DC-HSPA+ guaranteed connectivity, even in areas that do not yet have LTE coverage.

The industry standard Mini PCIe package enables easy integration onto an application board, and is also ideal for manufacturing of small series.

MPCI-L2 modules are manufactured in ISO/TS 16949 certified sites, with the highest production standards and the highest quality and reliability. Each module is fully tested and inspected during production.

The MPCI-L2 series comes in module variants for North America, Europe/ Asia/ Africa, APAC/ South America, and Japan.

USB drivers and RIL software for Android are free of charge.

	MPCI-L200	MPCI-L201	MPCI-L210	MPCI-L220	MPCI-L280
Grade					
Automotive					
Professional	•	•	•	•	•
Standard					
Regions					
	North America	North America	EU/ APAC	Japan	S. America/ APAC
Access technology					
GSM/GPRS bands	Q		Q		Q
UMTS/HSPA [MHz]	850, 900, 1700, 1900, 2100	850, 1900	850, 900, 1900, 2100	850, 900, 2100	850, 900, 1900, 2100
LTE FDD bands	2, 4, 5, 7, 17	2, 4, 5, 13, 17	1, 3, 5, 7, 8, 20	1, 3, 5, 8, 19	1, 3, 5, 7, 8, 28
Data rate	Cat 4	Cat 4	Cat 4	Cat 4	Cat 4
Interfaces					
USB	1	1	1	1	1
Features					
Network indication	•	•	•	•	•
Antenna detection					
Embedded TCP/UDP	•	•	•	•	•
Embedded FTP/HTTP	•	•	•	•	•
Embedded TLS 1.2	•	•	•	•	•
FW update via serial	•	•	•	•	•
FOTA	•	•	•	•	•
Rx diversity	•	•	•	•	•
Dual stack IPv4/IPv6	•	•	•	•	•
MIMO 2x2	•	•	•	•	•

Q = Quad-band

Cat 4 = LTE Cat 4 (150 Mb/s download, 50 Mb/s upload)



Features

LTE	Cat 4 (150 Mbit/s DL, 50 Mbit/s UL) 3GPP Release 9 FDD Bands: – MPCI-L200: 2, 4, 5, 7, 17 (N. America) – MPCI-L201: 2, 4, 5, 13, 17 (USA) – MPCI-L210: 1, 3, 5, 7, 8, 20 (EU/Asia/Africa) – MPCI-L220: 1, 3, 5, 8, 19 (Japan) – MPCI-L280: 1, 3, 5, 7, 8, 28 (APAC/S. America) All channel bandwidths: 1.4 - 20 MHz MIMO 2x2 Rx diversity
UMTS/DC-HSPA+	Bands (in MHz): – MPCI-L200: 850/900/AWS/1900/2100 – MPCI-L201: 850/1900 – MPCI-L210: 850/900/1900/2100 – MPCI-L220: 850/900/2100 – MPCI-L280: 850/900/1900/2100 42 Mbit/s downlink, 5.76 Mbit/s uplink
GSM	Bands (in MHz): – MPCI-L200: 850/900/1800/1900 – MPCI-L210: 850/900/1800/1900 – MPCI-L280: 850/900/1800/1900 GPRS & EDGE Class 12
SMS	MT/MO PDU / Text mode SMS over IMS and via SMS-C

Software features

Protocols	Dual stack IPv4 / IPv6 Embedded TCP/IP, UDP/IP HTTP/FTP/SSL (Secure Socket Layer)
Firmware upgrade	Via USB Via FOTA

Interfaces

RF (antenna)	2 UFL (50 Ω) Connectors (main and diversity)
Data	1 USB 2.0 (high-speed, 480 Mbit/s)
(U)SIM	Supports 1.8 V and 3 V, SIM toolkit

Package

52-pin PCI Express Full-Mini Card Type F2
30.0 x 51.0 x 3.7 mm, 9.7 g (components on top side only)

Electrical data

Power supply	DC 3.0 - 3.6 V
Consumption current	Connected mode LTE max power: 815 mA Idle mode: 1.8 mA

Environmental data, quality & reliability

Operating temperature –40 °C to +85 °C (extended range)

RoHS compliant (lead-free)

Manufactured in ISO/TS 16949 certified production sites

Certifications and approvals

MPCI-L200	PTCRB, GCF, FCC, ISED (formerly known as IC), RED (formerly known as R&TTE), AT&T, Anatel (Brazil)
MPCI-L201	FCC, ISED (formerly known as IC)
MPCI-L210	PTCRB, GCF, FCC, ISED (formerly known as IC), RED (formerly known as R&TTE), NCC, KCC (Korea), Giteki (Japan), Softbank (Japan), RCM (Australia) Operator approvals
MPCI-L220	Giteki (Japan)
MPCI-L280	PTCRB, GCF, FCC, ISED (formerly known as IC), RED (formerly known as R&TTE), Anatel (Brazil), NCC (Taiwan), RCM (Australia)

Support products

RIL software	Available for Android
USB driver	Available for Embedded Windows 6.0, 7, 2013 and Windows 7, 8, 8.1, 10

Product variants

MPCI-L200	LTE Cat 4 modules for North America; 2G and 3G fallback; LTE bands 2, 4, 5, 7, 17
MPCI-L201	LTE Cat 4 modules for North America; 3G fallback; LTE bands 2, 4, 5, 13, 17
MPCI-L210	LTE Cat 4 modules for Europe and APAC; 2G and 3G fallback; LTE bands 1, 3, 5, 7, 8, 20
MPCI-L220	LTE Cat 4 modules for Japan; 3G fall-back; LTE bands 1, 3, 5, 8, 19
MPCI-L280	LTE Cat 4 modules for APAC and South America; 2G and 3G fallback; LTE bands 1, 3, 5, 7, 8, 28



SARA-U201 module

HSPA module with 2G fallback

The world's smallest global HSPA/GSM modules

- Versatile 3G product with many configuration options
- Automotive-grade and ATEX-certified options available
- Easy migration between u-blox 2G, 3G and 4G modules
- Supports eCall, ERA GLONASS, CellLocate® indoor positioning, and GNSS / A-GNSS integration
- Extended temperature range of -40 °C to +85 °C



Standard



Professional



Automotive

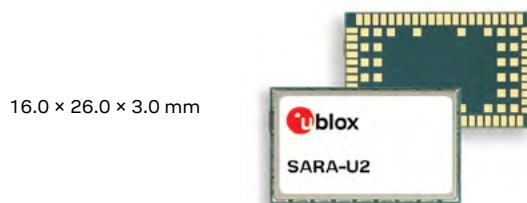

16.0 × 26.0 × 3.0 mm

SARA-U201^A

Product description

The SARA-U201 UMTS/HSPA module provides efficient and cost-effective high-speed mobile connectivity in an ultra-small LGA form factor. The SARA-U201 offers seamless drop-in migration from GSM (SARA-G3 modules) and CDMA (LISA-C modules) as well as easy migration to LTE (TOBY-L / TOBY-R / LARA-R modules).

SARA-U201 features HSPA data-rates of 7.2 Mbit/s (downlink) and 5.76 Mbit/s (uplink). The module has an extended operating temperature range of -40°C to +85°C, low power consumption, and a rich feature set including dual-stack IPv4 / IPv6.

SARA-U201 is ideal for a wide range of industrial and consumer applications, such as connected navigation systems, mobile-internet devices, security and surveillance systems, eCall, fleet management, metering, anti-theft systems, and other automotive applications.

The SARA-U201 module provides a fully integrated interface to u-blox satellite positioning chips and modules to support telematics applications.

An extensive set of national regulatory and operator certificates is available. RIL software for Android is available free of charge.

SARA-U201 is manufactured in ISO/TS 16949 certified sites. Each module is tested and inspected during production. The modules are qualified according to ISO 16750 – Environmental conditions and electrical testing for electrical and electronic equipment for road vehicles.

Grade	
Automotive	•
Professional	•
Standard	
Regions	
	Global
Access Technology	
GSM/GPRS bands	Q
UMTS/HSPA [MHz]	800, 850, 900, 1900, 2100
Data rate	M
Positioning	
GNSS via modem §	•
AssistNow Software	•
CellLocate®	•
eCall / ERA GLONASS	•
Interfaces	
UART	2
USB	1
DDC for u-blox GNSS	1
GPIO	9
Audio	
Digital audio	1
Features	
Antenna detection	•
Jamming detection	•
Embedded TCP/UDP	•
Embedded FTP/HTTP	•
Embedded SSL	•
FW update via serial	•
FOTA	•
Dual stack IPv4/IPv6	•

M = 7.2 / 5.76 Mb/s down/up
Q = Quad-band

A = ATEX variant available
§ = external GNSS can be controlled via the modem



Features

UMTS/HSPA	800/850/900/1900/2100 MHz 3GPP Release 7 5.76 Mbit/s uplink, 7.2 Mbit/s downlink
GSM	Quad-band, 850/1900, 900/1800 MHz
GPRS	Class 12, CS1-CS4, up to 85.6 kbit/s
EDGE	Class 12, MCS1-9, up to 236.8 kbit/s
CSD	GSM max 9.6 kbit/s UMTS max 64 kbit/s
SMS	MT/MO PDU / Text mode
Voice	HR/FR/EFR/AMR/AMR-WB Echo cancellation and noise reduction

Software features

Protocols	Dual stack IPv4/IPv6 Embedded TCP/IP, UDP/IP HTTP/FTP/SSL (Secure Socket Layer) SSL TLS 1.2 (for embedded TCP/IP) Ethernet over USB eSIM and Bearer-Independent-Protocol
Network	Jamming detection
GNSS Interfaces	Direct access to u-blox GNSS via SARA AssistNow software for fastest GNSS Time-to-First-Fix CellLocate® & Hybrid Positioning
Emergency calling	E911 (USA) European eCall, eMLPP
Other	ODIS feature for AT&T Protect network from excessive signaling traffic Last gasp (for "04" versions onwards)
Firmware upgrade	Via UART and USB FOTA (Firmware upgrade over the air) client (for "04" versions onwards)

Interfaces

GPIO	9 GPIO, controllable via AT commands
(U)SIM	Supports 1.8 V and 3.0 V, SIM toolkit
Serial	2 UART for "04" versions onwards 1 UART for all other variant versions 1 USB 2.0 (high-speed, 480 Mbit/s) 1 DDC (I ² C) for GNSS and other I ² C slaves
Audio	1 digital

Package

96 pin LGA: 16.0 x 26.0 x 3.0 mm, < 3 g

Environmental data, quality & reliability

Operating temperature	-40 °C to +85 °C (extended range)
RoHS compliant (lead-free)	
Qualification according to ISO 16750	
Manufactured in ISO/TS 16949 certified production sites	
ATEX certification (SARA-U201 ATEX variant)	

Electrical data

Power supply	3.3 V to 4.4 V
Power consumption	Power off 65 µA Idle (2G) 0.9 mA Idle (3G) 0.9 mA GPRS 215 mA (850 MHz, 900 MHz) 140 mA (1800 MHz, 1900 MHz) HSDPA 580 mA HSPA 460 mA

Certifications and approvals

SARA-U201	ATEX, PTCRB, GCF, FCC (USA), ISED (Canada), RED (CE), RCM (Australia), SRRC/CCC (China), NCC (Taiwan), Giteki (Japan), Anatel (Brazil), AT&T, Rogers, NTT DoCoMo
-----------	--

Support products

EVK-U201SARA	Evaluation kit specifically for SARA-U201
RIL software	Android
USB driver	Embedded Windows 6.x, 7.x Windows XP, Vista, 7, 8, 10 Windows Mobile 6.5

Product variants

SARA-U201	HSPA/GSM for global coverage
SARA-U201 ATEX	HSPA/GSM for global coverage; ATEX



LISA-U2 series

HSPA(+) modules with 2G fallback

Worldwide UMTS/HSPA(+) and GPRS/EDGE coverage

- HSDPA 21.1 Mbit/s, HSUPA 5.76 Mbit/s
- Easy migration between u-blox 2G, 3G and 4G modules
- Supports eCall, ERA GLONASS, CellLocate® indoor positioning, and GNSS / A-GNSS integration
- Extended temperature range of -40 °C to +85 °C



Standard



Professional



Automotive

22.4 × 33.2 × 2.6 mm



Product description

With 6-band W-CDMA(UMTS) and quad-band GPRS/EDGE, the LISA-U2 modules are suited for networks worldwide. Features include data-rates of up to 21.1 Mbit/s (downlink), a rich set of internet protocols, very small footprint, very low power consumption and extended operating temperature range. LISA-U2 modules provide fully integrated access to u-blox positioning products. Antenna diversity permits the LISA-U2 modules to provide the highest data speeds.

LISA-U2 modules are ideal for consumer/industrial applications requiring high-speed data transmission, and machine-to-machine applications. They are the perfect choice for mobile internet terminals, tablets, in-car infotainment, connected navigation systems, security and surveillance systems, eCall, fleet management, metering, anti-theft systems, and other automotive applications.

The compact SMT package enables easy manufacturing, and migration from u-blox SARA, LEON, and other LISA modules is simple. This allows customers to take maximum advantage of their hardware and software investments, and provides very short time-to-market. An extensive set of national regulatory and operator certificates is available. RIL software for Android is available free of charge.

LISA-U2 modules are manufactured in ISO/TS 16949 certified sites. Each module is tested and inspected during production. The modules are qualified according to ISO 16750 - Environmental conditions and electrical testing for electrical and electronic equipment for road vehicles.

	LISA-U200	LISA-U201	LISA-U230
Grade			
Automotive		•	
Professional	•	•	•
Standard			
Regions			
	Global	Global	Global
Access technology			
GSM/GPRS bands	Q	Q	Q
UMTS/HSPA [MHz]	800, 850, 900, 1700, 1900, 2100	800, 850, 900, 1900, 2100	800, 850, 900, 1700, 1900, 2100
Data rate	M	M	+
Positioning			
GNSS via modem §	•	•	•
AssistNow Software	•	•	•
CellLocate®	•	•	•
eCall / ERA GLONASS	•	•	
Interfaces			
UART	1	1	1
USB	1	1	1
DDC for u-blox GNSS	1	1	1
SPI	1	1	1
GPIO	14	14	14
Audio			
Digital audio	2	2	2
Features			
Antenna detection	•	•	•
Jamming detection	•	•	•
Embedded TCP/UDP	•	•	•
Embedded FTP/HTTP	•	•	•
Embedded SSL	•	•	•
FW update via serial	•	•	•
FOTA	•	•	
Rx diversity			•
Dual stack IPv4/IPv6	•	•	

M = 7.2 / 5.76 Mb/s down/up
+ = 21.1 / 5.76 Mb/s down/up

§ = external GNSS can be controlled via the modem

Q = Quadband



Features

UMTS/HSPA	800/850/900/1700/1900/2100 MHz (Bands VI, V, VIII, IV, II, I) 3GPP Release 7 5.76 Mbit/s uplink, 21.1 Mbit/s downlink or 5.76 Mbit/s uplink, 7.2 Mbit/s downlink
GSM	GSM 850 / 900 / 1800 / 1900 MHz 3GPP Release 7, PBCCH support
GPRS	Class 12, CS1-CS4 – up to 86.5 kbit/s
EDGE	Class 12, MCS1-9 – up to 236.8 kbit/s
CSD	GSM max 9.6 kbit/s UMTS max 64 kbit/s
SMS	MT/MO PDU / Text mode
Voice	HR/FR/EFR/AMR/AMR-WB

Software features

Protocols	Embedded TCP/IP, UDP/IP HTTP/FTP/SSL (Secure Socket Layer) SSL TLS 1.2 (for embedded TCP/IP) Ethernet over USB eSIM and Bearer-Independent-Protocol
Network	Jamming detection
GNSS Interfaces	Direct access to u-blox GNSS via LISA AssistNow software for fastest GNSS Time-to-First-Fix CellLocate® & Hybrid Positioning
Emergency calling	E911 (USA) European eCall, eMLPP
Other	Protect network from excessive signaling traffic Last gasp
Firmware upgrade	Via UART, USB, and SPI Via FOTA for 04B versions

Environmental data, quality & reliability

Operating temperature	-40 °C to +85 °C (extended range)
RoHS compliant (lead-free)	
Qualification according to ISO 16750	
Manufactured in ISO/TS 16949 certified production sites	

Interfaces

GPIO	Up to 14 GPIOs, configurable
(U)SIM	Supports 1.8 V and 3.0 V, SIM toolkit
Serial	1 UART, 1 SPI, DDC, 1 USB 2.0 (high-speed, 480 Mbit/s)
Audio	2 digital

Package

76 pin LCC (Leadless Chip Carrier): 22.4 x 33.2 x 2.6 mm, < 7 g

Electrical data

Power supply	3.3 V to 4.4 V	
Power consumption	Power off	55 µA
	Idle (2G, DRX5)	1.3 mA
	Idle (3G, DRX7)	1.7 mA
	GSM voice	175 mA (bands II & III)
	UMTS voice	385 mA (band V)
	GPRS data	175 mA (1 Tx slot, bands II & III) 400 mA (4 Tx slots, bands II & III)
	HSPA	500 – 800 mA (depends on frequency band)

Certifications and approvals

RED (formerly known as R&TTE), ISED (formerly known as IC), PTCRB, GCF, FCC, Giteki (Japan), RCM (Australia), CCC (China), NCC (Taiwan), KCC (Korea), IDA (Singapore), ANATEL (Brazil), ICASA (S. Africa)

AT&T, DoCoMo, Softbank, SKT, Telstra (Australia), Vodafone, BellMobility, Telus, Rogers (Canada), ViVo (Brazil)

Support products

ADP-U200 / ADP-U201	Adapter boards for LISA-U2 series
RIL software	Android
USB driver	Embedded Windows 6.x, 7.x Windows XP, Vista, 7, Windows Mobile 6.5

Product variants

LISA-U200	UMTS/HSPA, quad-band GPRS/EDGE, 800/850/900/1700/1900/2100 MHz
LISA-U201	UMTS/HSPA, quad-band GPRS/EDGE, 800/850/900/1900/2100 MHz
LISA-U230	UMTS/HSPA+, quad-band GPRS/EDGE, 800/850/900/1700/1900/2100 MHz



SARA-G450 module

Quad-band GSM/GPRS module

Ideal for cost-optimized solutions

- Industry proven SARA form factor
- Easy migration between u-blox 2G, 3G, LPWA (LTE-M and NB-IoT), LTE Cat 4 and LTE Cat 6 modules
- Simple integration with embedded internet suite
- Optimized power consumption for IoT applications

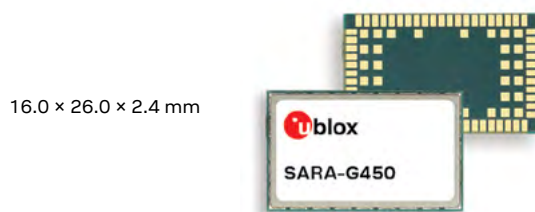

SARA-G450

Grade	
Automotive	
Professional	
Standard	•
Regions	
	Global
Access technology	
GSM/GPRS bands	Q
Data rate	85.6 kb/s *
Positioning	
GNSS via modem §	•
AssistNow software	•
CellLocate®	•
Interfaces	
UART	3
DDC for u-blox GNSS	•
GPIO	4
Audio	
Analog audio	•
Digital audio	
Features	
Antenna detection	•
Jamming detection	•
Embedded TCP/UDP	•
Embedded FTP/HTTP	•
Embedded SSL	•
FW update via serial	•
Dual stack IPv4/IPv6	•

Product description

The SARA-G450 GSM/GPRS module features class 12 GSM/GPRS connectivity in the popular u-blox SARA form factor.

The SARA-G450 module is an ideal solution for cost and space-sensitive applications. It offers an excellent price-to-performance ratio for all M2M applications where environmental conditions (temperature, EMC and mechanical stresses) are within standard levels.

Its rich feature set – including GSM/GPRS class 12 and simple integration – enable customers to easily integrate the module and develop a wide range of M2M devices.

Thanks to its pin compatibility with the u-blox modules SARA-G3 (GSM), SARA-U2 (HSPA), SARA-R5/SARA-R4 (LTE-M/NB-IoT), SARA-N3 (NB-IoT), TOBY-L4 (LTE Cat 6) TOBY-L2 (LTE Cat 4) and TOBY-R2/LARA-R2/LARA-R3121 (LTE Cat 1), the SARA-G450 allows customers to utilize the same PCB design, thus targeting various environmental requirements and different cellular technologies.

u-blox cellular modules are certified and approved by the main regulatory bodies and operators.

§ = Control of external GNSS via the modem * = GPRS class 12 (downgradeable to class 10 via AT command)
Q = Quad-band



Features

GSM	GSM 850/900/1800/1900 MHz 3GPP Release 99
GPRS	GPRS class 12 (downgradeable to class 10 with AT command) CS1-CS4 - up to 85.6 kbit/s PBCCH support
AT Commands	3GPP TS 27.005, 3GPP TS 27.007 u-blox AT command extension 3GPP 27.010 MUX protocol
SMS	MT/MO Text/PDU mode
Firmware upgrade	Via UART
Voice	Codec: HR / FR / EFR / AMR
Protocols	Embedded TCP/IP, UDP/IP, HTTP, FTP, SSL and TLS 1.2 support
GNSS Interfaces	Direct access to u-blox GNSS via module CellLocate® & Hybrid Positioning
Special features	IPv6 support over PPP

Electrical data

Power supply	3.40 V to 4.20 V
Digital I/O voltage level	1.8 V / 2.8 V to 3.0 V (selectable)
Power consumption	Power Off: < 100 µA Idle mode: < 1.5 mA Connected: < 230 mA

Interfaces

Antenna	50 Ω SMT pad
Serial Port	2 UART for data and AT commands 1 UART for FW upgrade and tracing
SIM	1.8 V and 3.0 V
GPIO	4, controllable over AT commands
GNSS serial	1 DDC (I ² C)
Audio	1 analog

Package

96 pin LGA: 16.0 x 26.0 x 2.4 mm, < 3 g

Environmental data, quality & reliability

Operating temperature -40 °C to +85 °C (extended range)

RoHS compliant (lead-free)

Certifications and approvals

SARA-G450 modules offer a comprehensive set of regulatory certifications and approvals, including RED, ICASA, SRRC/CCC, GCF, and Anatel.

Contact your closest u-blox representative for the latest approvals.

Support products

EVK-G45 Evaluation Kit for SARA-G450

Product variants

SARA-G450 Quad-band GSM/GPRS module



SARA-G3 series

Dual and quad-band GSM/GPRS modules

Automotive-grade and ATEX-certified options

- Very small SARA LGA form factor for easy manufacturing
- Industry-leading, low power consumption (<0.90 mA standby)
- Separate power supply extends battery life
- Easy migration between u-blox 2G, 3G and 4G modules
- Supports eCall and ERA-GLONASS, CellLocate® indoor positioning and GNSS / A-GNSS integration

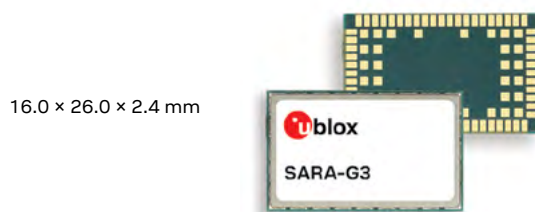

Product description

The SARA-G3 series of GSM/GPRS modules feature extremely low power consumption and a miniature LGA form factor. SARA-G3 modules are interchangeable, and have been designed with the diverse needs of M2M customers in mind. Different functionalities and feature sets are available to meet different customer and application requirements.

SARA-G340/G350 are full-feature GSM/GPRS modules with a comprehensive feature set, including an extensive set of internet protocols (TCP, UDP, HTTP, FTP and SMTP). They have fully integrated access to u-blox GNSS positioning chips and modules, along with embedded A-GNSS (AssistNow Online and AssistNow Offline) functionality. SARA-G350 is the quad-band version for global connectivity and SARA-G340 (900/1800 MHz) is the dual-band version for cost-optimized use in Europe and Asia. Their rich feature set enables customers to easily develop a wide range of M2M devices with minimum software development on the host processor.

SARA-G340 ATEX and SARA-G350 ATEX are ATEX / IECEx certified variants that further complement the product series by offering the ideal solution for the development of smart devices deployed in potentially explosive environments.

u-blox cellular modules are certified and approved by the main regulatory bodies and operators. RIL software for Android is available free of charge. SARA-G3 modules are manufactured in ISO/TS 16949 certified sites. Each module is tested and inspected during production. The modules are qualified according to ISO 16750 – Environmental conditions and electrical testing for electrical and electronic equipment for road vehicles.

	SARA-G340 ^A	SARA-G350 ^A
Grade		
Automotive		•
Professional	•	•
Standard		
Regions		
	EU/APAC	Global
Access technology		
GSM/GPRS bands	D1	Q
Data rate	85.6 kb/s	85.6 kb/s
Positioning		
GNSS via modem §	•	•
AssistNow Software	•	•
CellLocate®	•	•
eCall / ERA GLONASS	•	•
Interfaces		
UART	2	2
DDC for u-blox GNSS	1	1
GPIO	4	4
Audio		
Analog audio	1	1
Digital audio	1	1
Features		
Antenna detection	•	•
Jamming detection	•	•
Embedded TCP/UDP	•	•
Embedded FTP/HTTP	•	•
Embedded SSL	•	•
FW update via serial	•	•
Dual stack IPv4/IPv6	•	•

§ = external GNSS can be controlled via the modem
A = ATEX variant available

D1 = Dual-band 900/1800 MHz
Q = Quad-band



Features

GSM	GSM 850/900/1800/1900 MHz ¹ GSM 900 /1800 MHz ² 3GPP Release 99
GPRS	GPRS Class 10, CS1-CS4 - up to 85.6 kbit/s PBCC support
CSD	GSM max 9.6 kbit/s
AT Commands	3GPP 27.005, 3GPP 27.007 u-blox AT command extension 3GPP 27.010 MUX protocol
SMS	MT/MO Text/PDU mode
Firmware upgrade	Via UART
Voice	HR / FR / EFR / AMR Echo cancellation Noise reduction
Protocols	Embedded TCP/IP, UDP/IP, HTTP/FTP, SSL and TLS 1.2 support
Network	Jamming detection
GNSS Interfaces	Direct access to u-blox GNSS via module AssistNow software for faster acquisition CellLocate® & Hybrid Positioning
Special features	In-band modem Bearer Independent Protocol (BIP) IPv6 support over PPP eCall and ERA-GLONASS support

1 = SARA-G350
2 = SARA-G340

Electrical data

Power supply	3.00 V to 4.50 V (extended)	
Power consumption	Power Off:	< 40 µA
	Idle mode:	< 0.9 mA
	Idle mode:	< 5.0 mA
	Connected:	< 250 mA

Interfaces

Antenna	50 Ω SMT pad
Serial Port	1 UART for data and AT commands 1 UART for AT commands, tracing, and FW update
SIM	1.8 V and 3.0 V
GPIO	4, controllable over AT commands
GNSS serial	1 DDC (I ² C)
Audio	1 analog 1 digital (I ² S/PCM)

Package

96 pin LGA: 16.0 x 26.0 x 2.4* mm, < 3 g
* Module height is 2.4 mm from version 02 onwards (3 mm in version 01)

Environmental data, quality & reliability

Operating temperature	-40 °C to +85 °C (extended range)
RoHS compliant (lead-free)	
Qualification according to ISO 16750	
Manufactured in ISO/TS 16949 certified production sites	
ATEX / IECEx certification (SARA-G350 ATEX and SARA-G340 ATEX)	

Certifications and approvals

SARA-G3 modules offer a comprehensive set of regulatory certifications and approvals, including GCF, PTCRB, FCC, ICASA, RED (formerly known as R&TTE), ISED (formerly known as IC), NCC, and Anatel. Contact your closest u-blox representative for latest approvals.

Support products

EVK-G35	Evaluation Kit for SARA-G340/G350
RIL software	Android

Product variants

SARA-G340	Dual-band (900/1800 MHz) GSM/GPRS module
SARA-G340 ATEX	Dual-band (900/1800 MHz) GSM/GPRS module, ATEX/IECEx certified
SARA-G350	Quad-band GSM/GPRS module
SARA-G350 ATEX	Quad-band GSM/GPRS module, ATEX/IECEx certified



UBX-R5

Multi-band LTE-M / NB-IoT chipset

IoT security redefined in a 5G-ready LTE-M and NB-IoT chipset

- First Common Criteria EAL5+ High certified cellular IoT Secure Element provides best-in-class hardware-based security
- 5G-ready, software-configurable cellular modem to last an IoT lifetime
- Service-on-chip architecture captures signal deep inside hardware for improved positioning and energy efficiency
- Easy integration with u-blox GNSS products and operation of LTE-based positioning
- Powerful edge computing platform provides a hosted application environment



Product description

The UBX-R5 is a 5G-ready, multi-band LTE-M / NB-IoT chipset that provides industry-leading hardware-based security to a wide range of low-power wide-area (LPWA) IoT devices. It includes the first Common Criteria (CC) EAL5+ High certified IoT Secure Element with a hardware Root of Trust, enabling the strongest protection against attacks on mission-critical IoT assets or devices that transmit sensitive information.

Due to the high degree of software configurability within the third generation in-house VSP-based modem processor, the UBX-R5 chipset is 5G-ready and offers platform stability and longevity to customer devices.

UBX-R5 is based on a service-on-chip architecture, which offers low-level insights and data points from deep within the hardware, such as event-based energy consumption monitoring and smart antenna tuning, among others.

The chipset can be easily combined with any u-blox GNSS product.

The UBX-R5 chipset includes integrated RF, baseband, power management and RAM and supports several power-saving functionalities, such as PSM and eDRX. Further, it supports enhanced LTE coverage via CE Mode A and B for LTE-M, and ECL1 and ECL2 for NB-IoT, achieving deeper penetration inside buildings and underground.

	UBX-R5
Grade	
Automotive	
Professional	•
Standard	
Regions	
	Multi-region
Access technology	
LTE bands	*
Data rate	M1/NB2
Interfaces	
UART	•
USB	•
DDC (I ² C)	•
SDIO (host) 4-bit	•
ADC	•
PWM	•
I ² S	•
GPIO	•
Features	
EAL5+ High secure element	•
Hardware Root of Trust	•
Application CPU	•
Coverage Enhancement Mode A and B	•
PSM and eDRX	•
Dynamic antenna tuning	•

* = All bands within the 450 MHz to 2.46 GHz range NB2 = Cat NB2 (125 kbit/s DL, 140 kbit/s UL)
 M1 = LTE Cat M1 (375 kbit/s DL, 1200 kbit/s UL)



Features

LTE standards	3GPP Release 13 LTE Cat M1 and NB1 3GPP Release 14 LTE Cat M1: Coverage Enhancement Mode B, Uplink TBS of 2984b 3GPP Release 14 LTE Cat NB2: Higher data rate (TBS of 2536b), Mobility enhancement (RRC connection re-establishment), E-Cell ID, Lower power class PC6 (14 dBm), two HARQ processes, Release Assistant, Random access on Non-Anchor Carrier Cat M1 Half-duplex, 375 kbit/s DL, 1200 kbit/s UL Cat NB2 Half-duplex, 125 kbit/s DL, 140 kbit/s UL
LTE channels	375 kb/s UL/DL HD-FDD PDSCH modes (TM) 1, 2 MPDCCH SMS over SGS RAN overload control for MTC – extended access barring R11 Coverage extension A, B I-DRX, C-DRX, PSM
Security	Root of Trust - Embedded Secure Element EAL5+ High
GNSS	External
Bands	Software selectable HD-FDD band configurations enables single hardware SKU supporting all 3GPP bands from 450 MHz to 2.46 GHz, depending on external components
Application CPU	Industrial grade

Interfaces

Serial	UART USB SPI DDC (I ² C) SDIO (host) 4-bit ADC PWM I ² S
GPIO	Up to 15 GPIOs, configurable
SIM	ISO 7816-3
GNSS	1 Time sync

Package

FCBGA package	8.5 x 9.0 x 1.0 mm 395 pins
Pitch	0.4 mm

Environmental data, quality & reliability

Operating temperature	-40 °C to +85 °C (AEC-Q100 certified)
Storage temperature	TBD
RoHS compliant (lead-free) and green (no halogens)	
Manufactured in ISO/TS 16949 certified production sites	

Certifications and approvals

Module dependent

Electrical data

Power supply	Range 3.3 V to 4.4 V
Power consumption	TBD

Product variants

UBX-R5	u-blox LTE-M and NB-IoT chipset for multi-regional use
--------	--

Short Range Radio





	Bluetooth Bluetooth BR/EDR	Bluetooth Bluetooth low energy	Wi-Fi Wi-Fi IEEE 802.11	NFC	Thread & Zigbee	u-blox u-connect Xpress	u-blox u-connect Script	Open CPU	Standard	Professional	Automotive
Stand-alone modules											
ANNA-B112		v5		•		•		•		•	
NINA-B1		v5		•		•		•		•	
NINA-B2	v4.2	v4.2				•					•
NINA-B3		v5		•	•	•	•	•		•	•
NINA-B4		v5.1		•	•			•		•	•
BMD-360		v5.1			•			•		•	•
BMD-34/38		v5		•	•			•		•	•
BMD-330		v5						•		•	•
BMD-30/35		v5		•				•		•	•
R41Z		v4.2			•			•		•	•
ODIN-W2	v4	v4	a/b/g/n 2.4 GHz, 5 GHz			•		•		•	•
NINA-W10	v4.2	v4.2	b/g/n 2.4 GHz					•		•	•
NINA-W15	v4.2	v4.2	b/g/n 2.4 GHz			•				•	•
NINA-W13			b/g/n 2.4 GHz			•				•	•
Host-based modules											
JODY-W2	v5	v5	a/b/g/n/ac 2.4 GHz, 5 GHz								• •
JODY-W1	v5	v5	a/b/g/n/ac 2.4 GHz, 5 GHz								•
EMMY-W1	v4.2	v4.2	a/b/g/n/ac 2.4 GHz, 5 GHz								• •
LILY-W1			b/g/n 2.4 GHz								•
V2X chips and modules											
VERA-P1			p 5.9 GHz								•
UBX-P3			a: 5 GHz p: 5.9 GHz, 760 MHz								•

Host-based and stand-alone architectures

Customer 3rd party u-blox

Stand-alone

u-connectXpress

- Stack runs on u-blox short range module
- Application runs on the external MCU

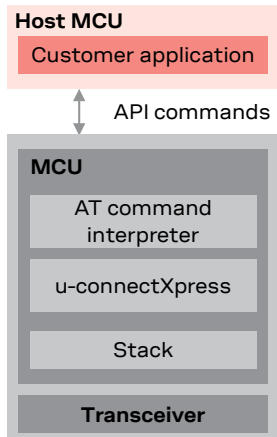

u-connectScript

- Stack runs on u-blox short range module
- Application runs on the u-blox module, and is based on script engine

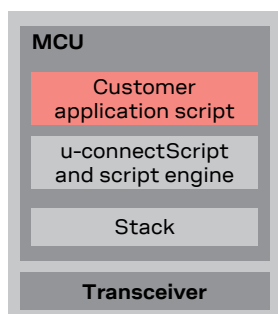

open CPU

- Stack runs on u-blox short range module
- Application runs on the u-blox module, and is based on 3rd party SDK

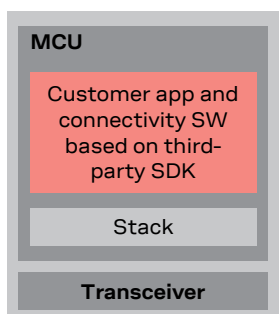

Host-based

- Third party stack runs on a host processor with open OS
- Application runs on the host processor

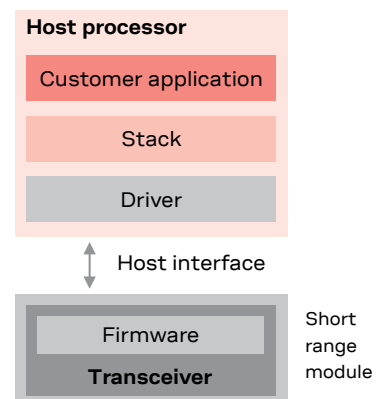



NINA-B40 series

Stand-alone Bluetooth 5.1 low energy modules

Bluetooth 5.1 module for harsh professional environments

- Bluetooth 5.1, Bluetooth mesh, Thread, and Zigbee
- Direction finding support for indoor location
- Powerful MCU with open CPU architecture for customized applications
- Extended temperature range up to 105 °C
- Pin compatible with other NINA modules
- Global certification

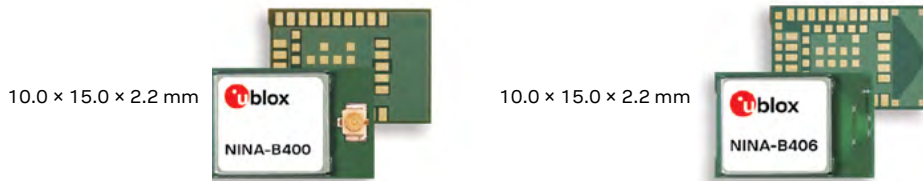

Product description

The NINA-B40 series are small, stand-alone Bluetooth low energy wireless microcontroller unit (MCU) modules that comply with the Bluetooth 5.1 specification.

The module is built on the Nordic nRF52833 chip and comes as an open CPU where customer applications run on the built-in Arm® Cortex®-M4 with FPU. NINA-B40 modules integrate flash and RAM memory, and the application runs on top of the embedded Bluetooth low energy stack. Bluetooth low energy services such as serial port communication, GATT, beacons, and mesh are also supported. For location applications, NINA-B40 supports the direction finding features such as Angle-of-Arrival and Angle-of-Departure from the Bluetooth 5.1 specification. These methods determine the direction from which a signal is transmitted. This improves location accuracy as compared to the received signal strength (RSSI). NINA-B40 can act both as a transmitter and receiver in a direction finding application. NINA-B40 provides an extended communication range or a more reliable connection using the Bluetooth 5 long range feature.

Additionally, the modules support NFC and IEEE 802.15.4 with Thread and Zigbee. A range of wired interfaces (UART, SPI, I2C, I2S, USB, QDEC, PDM, PWM, and ADC) are available. Key market segments are smart cities and buildings, industrial automation, medical and healthcare, and telematics. Specific applications include smart lighting, asset tracking, indoor location, low power sensors, as well as wireless-connected and configurable equipment.

NINA-B406 comes with an internal PCB antenna while NINA-B400 comes with a U.FL connector for use with an external antenna of choice. The internal PCB antenna provides a robust low profile solution with high performance and an extensive range. The NINA-B40 series will be globally certified for use with the internal antenna or a range of external antennas. This greatly reduces time, cost and effort for customers integrating Bluetooth low energy in their designs.

	NINA-B400	NINA-B406
Grade		
Automotive		
Professional	•	•
Standard		
Radio		
Chip inside	nRF52833	
Bluetooth qualification	v5.1	v5.1
Bluetooth low energy	•	•
Thread / Zigbee	•	•
Bluetooth output power EIRP [dBm]	10	10
Max range [meters]	1400	1400
NFC	•	•
Antenna type (see footnotes)	U.FL	pcb
Application software		
Open CPU for embedded applications	•	•
Interfaces		
UART	◆	◆
SPI	◆	◆
I2C	◆	◆
I2S	◆	◆
USB	◆	◆
PDM and PWM	◆	◆
GPIO pins	38	38
AD converters [number of bits]	12	12
Features		
MCU (see footnotes)	M4F	M4F
RAM [kB]	128	128
Flash [kB]	512	512
Simultaneous GATT server and client	◆	◆
Throughput [Mbit/s]	1.4	1.4
Maximum Bluetooth connections	20	20
Secure boot	◆	◆
Bluetooth mesh	◆	◆
Direction finding (AoA/AoD)	◆	◆
FOTA	◆	◆

U.FL = U.FL connector(s) for external antenna
pcb = Internal PCB antenna

◆ = Feature enabled by HW. The actual support depends on the open CPU application SW.
M4F = 64 MHz Arm® Cortex®-M4 with FPU



Features

Bluetooth	v5.1 (Bluetooth low energy)
NFC	NFC-A tag support
Range	1400 m
Max. conducted output power	8 dBm
Conducted sensitivity	-94 dBm (1 Mbit/s) -100 dBm (125 Kbit/s)

Open CPU for customer application

Customers develop and embed their own application on top of the Bluetooth stack in the NINA-B40x modules (open CPU concept). This section describes the possible features enabled by the NINA-B40 hardware. Use Nordic Semiconductor's SDK environment to develop the connectivity and application software.

Development environment	Nordic SDK (including Bluetooth Mesh, HomeKit, AirFuel, IoT, Thread, Zigbee)
HW interfaces *	2 x UART 3 x SPI 1 x HS-SPI 38 x GPIO pins 8 x ADC channels 1 x USB 2 x I2C 1 x I2S 4 x PWM 1 x QDEC
Security	Secure boot ready Secure Simple Pairing 128-bit AES encryption Bluetooth low energy secure connections

* Not all simultaneously

Electrical data

Power supply	1.7 to 3.6 V
Power consumption	Active TX @ 0 dBm: 6.4 mA Standby: 1.3 µA Sleep: 400 nA (with wake-up on external event)

Package

Dimensions	10.0 x 15.0 x 2.2 mm
Weight	< 1.0 g
Mounting	Machine mountable Solder pins

Environmental data, quality & reliability

Operating temperature	-40 °C to +105 °C
Storage temperature	-40 °C to +105 °C
Humidity	RH 5 – 90% non-condensing

Certifications and approvals¹

Type approvals	Europe (ETSI RED); US (FCC/CFR 47 part 15 unlicensed modular transmitter approval); Canada (IC RSS); Japan (MIC); Taiwan (NCC); Australia (ACMA); New Zealand; Brazil (Anatel); South Korea (KCC); South Africa (ICASA)
Health and safety	EN 62479, EN 62368-1, IEC 62368-1
Bluetooth qualification	v5.1 (Bluetooth low energy)

¹ = Pending approvals

Support products

EVK-NINA-B400	Evaluation kit for NINA-B400 with open CPU and U.FL connector for the antenna
EVK-NINA-B406	Evaluation kit for NINA-B406 with open CPU and internal PCB antenna

Product variants

NINA-B400	Bluetooth low energy module with open CPU and U.FL connector for external antenna
NINA-B406	Bluetooth low energy module with open CPU and internal PCB antenna



BMD-380 module

Stand-alone Bluetooth 5 low energy modules

Ultra-compact full Bluetooth 5, Thread, and Zigbee (IEEE 802.15.4) solution

- Powerful, ultra-efficient 64 MHz 32-bit Arm® Cortex®-M4 with FPU, 1 MB Flash, and 256 kB RAM
- Miniature footprint of 7.5 x 9.5 mm to fit the most compact designs
- Bluetooth 5 long range support (Coded PHY)
- USB 2.0 and built-in DC-DC converter for direct USB / Li-Ion power
- Hardware cryptographic unit for secure boot and over-the-air updates
- Integrated chip antenna



7.5 x 9.5 x 1.5 mm



Product description

The BMD-380 module is an ultra-compact, advanced, highly flexible, low power multiprotocol module that enables concurrent Bluetooth 5, Thread and Zigbee (IEEE 802.15.4) connectivity for compact, portable, extremely low power embedded systems. The module fully integrates the highly capable Nordic Semiconductor nRF52840 chip with an optimized and complete radio design including a ceramic chip antenna and radio type approvals. With the Arm® Cortex®-M4 with FPU, integrated 2.4 GHz transceiver, an extended range of interfaces and embedded hardware cryptographic engine, the BMD-380 module provides a complete RF solution allowing faster time to market with reduced development costs and advanced security capabilities. Providing full use of the Nordic nRF52840's capabilities and peripherals, the BMD-380 can power the most demanding applications, all while simplifying designs with its very compact size and integrated antenna.

The BMD-380 is an ideal solution for size-constrained designs that require Bluetooth 5 features or 802.15.4 based networking for Thread and Zigbee. The Bluetooth 5 long range feature provides extended range and coverage. The built-in USB and 5.5 V compatible DC-DC supply reduce design complexity and BOM cost, while expanding possible applications. The modules are fully certified for Europe, US, Canada, and Australia/New Zealand.

BMD-380

Grade	
Automotive	
Professional	
Standard	•
Radio	
Chip inside	nRF52840
Bluetooth qualification	v5.0
Bluetooth low energy	•
Thread / Zigbee	•
Bluetooth output power EIRP [dBm]	7
Max range [meters]	500
NFC	•
Antenna type (see footnotes)	chip
Application software	
Open CPU for embedded applications	•
Interfaces	
UART	◆
SPI	◆
I2C	◆
I2S	◆
USB	◆
PDM and PWM	◆
GPIO pins	44
AD converters [number of bits]	12
Features	
MCU (see footnotes)	M4F
RAM [kB]	256
Flash [kB]	1024
Simultaneous GATT server and client	◆
Throughput [Mbit/s]	1.4
Maximum Bluetooth connections	20
Secure boot	◆
Bluetooth mesh	◆
FOTA	◆

chip = Internal chip antenna
 U.F.L = U.F.L antenna connector
 M4F = 64 MHz Arm® Cortex®-M4 with FPU

◆ = Feature enabled by HW. The actual support depends on the open CPU application SW.



Features

Bluetooth	v5.0 (Bluetooth low energy)
NFC	NFC-A tag support
Range	500 m
Max. radiated output power (EIRP)	7 dBm
Conducted sensitivity (Bluetooth mode)	-95 dBm (1 Mbit/s) -103 dBm (125 Kbit/s)
Bluetooth address	Unique public Bluetooth address provided (in flash)
Bluetooth operating modes	Simultaneous central and peripheral roles LE 2M PHY (2 Mbps) LE 1M PHY (1 Mbps) Coded PHY 500 kbps (long range) Coded PHY 125 kbps (long range) Advertising Extensions LE Data Length Extension Channel Selection Algorithm #2
Antenna	Ceramic chip antenna
Development environment	Nordic SDK (including Bluetooth Mesh, HomeKit, AirFuel, IoT) Customers develop and embed their own application on top of the Bluetooth stack in the BMD-380 module (open CPU concept)
Security	Arm® TrustZone® CryptoCell cryptographic unit Secure boot Secure Simple Pairing 128-bit AES encryption Bluetooth low energy secure connections

Interfaces and peripherals*

UART	2 blocks. 1200 baud to 1 M baud, parity, CTS and RTS support
SPI Master	4 blocks. 125 kHz to 8 Mhz clock rates
SPI Slave	3 blocks. 125 kHz to 8 Mhz clock rates
QSPI Master	1 block. Max 32 MHz. XIP support
TWI (I2C) Master	2 blocks. 100 kHz to 400 kHz clock rates
TWI (I2C) Slave	2 blocks. 100 kHz to 400 kHz clock rates
NFC	NFC-A, 13.56 MHz, 106 kbps, wake-on-field
PDM	1 block. 2 microphones (left/right) 16 kHz sample rate, 16-bit
I2S	1 block. Master and slave, bidirectional
ADC	8-ch, 12-bit @ 200 ksps
PWM	4 blocks, 4 channels each
LP Comparator	8-ch, VCC, int and ext ref, 15 levels
GP Comparator	8-ch, VCC and internal ref, 64 levels
Temp. Sensor	Internal, -40 °C to 85 °C, +/- 4 °C, 0.25 °C resolution
GPIO	44 GPIOs Input High: 0.7 x VCC; Input Low: 0.3 x VCC; 13 kΩ pull-up/pull-down
Timers	5 x 32-bit and 3 x 24-bit RTC with 12-bit prescaler, watchdog
USB peripheral	1 block. USB 2.0 full speed, 12 Mbps. 2 control, 14 bulk/interrupt endpoints

* Not all simultaneously

Package

Dimensions	7.5 x 9.5 x 1.5 mm
Mounting	Machine mountable Solder pins

Environmental data, quality & reliability

Operating temperature	-40 °C to +85 °C
Storage temperature	-40 °C to +125 °C
Humidity	RH 5 – 90% non-condensing
RoHS	RoHS 3 compliant

Electrical data

Power supply	1.7 VDC to 5.5 VDC
Power consumption in Bluetooth low energy mode	TX only @ +8 dBm 14.8 mA @ 3V TX only @ 0 dBm: 4.8mA @ 3V No RAM retention: 0.4 µA at 3 V No RAM retention, wake on RTC: 1.5 µA at 3 V

Certifications and approvals¹

Type approvals	Europe (ETSI RED); US (FCC/CFR 47 part 15 unlicensed modular transmitter approval); Canada (ISED RSS); Australia and New Zealand (RCM)
Health and safety	EN 62479, EN 60950-1, IEC 60950-1
Bluetooth qualification	v5.0 (Bluetooth low energy), Bluetooth RF PHY
1 Pending	

Support products

BMD-380-Eval	Evaluation kit for BMD-380 with open CPU and internal chip antenna
--------------	--

Product variants

BMD-380	With internal chip antenna, open CPU
---------	--------------------------------------



ANNA-B112 module

Stand-alone Bluetooth 5 low energy module

The smallest industrial Bluetooth 5 module

- Ultra compact SiP (6.5 x 6.5 x 1.2 mm)
- Bluetooth 5 and Bluetooth mesh
- u-connect software for accelerated time to market
- Open CPU for customer applications
- Internal antenna / antenna pin
- Global certification



6.5 x 6.5 x 1.2 mm

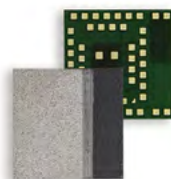

ANNA-B112

Product description

The ANNA-B112 is an ultra-small, high-performing, stand-alone Bluetooth low energy module. The System in Package (SiP) module features Bluetooth 5, a powerful Arm® Cortex®-M4 microprocessor with FPU, and state-of-the-art power performance. The ANNA-B112 is delivered with u-connectXpress software that provides support for u-blox Bluetooth low energy Serial Port Service, GATT client and server, beacons, NFC, and simultaneous peripheral and central roles – all configurable from a host by means of AT commands. ANNA-B112 offers full flexibility for customers who prefer their application to run on the built-in Arm Cortex-M4 with FPU. With 512 kB flash and 64 kB RAM, it offers the best-in-class capacity for customer applications running on top of the Bluetooth low energy stack using the SDK from Nordic Semiconductor or Arm Mbed. Additionally, SPI, I2C, and I2S interfaces are available, and features such as NFC, Bluetooth mesh, AirFuel, and Apple HomeKit are also supported. In combination with Wirepas Mesh stack, ANNA-B112 can form large-scale industrial mesh networks for several applications, such as lighting, asset tracking, and metering.

The ANNA-B112 module includes an integrated antenna providing a range of 160 m, and an antenna pin for design-in of an external antenna.

ANNA-B112 is globally certified for use with the internal or external antenna. This reduces time, cost and effort for customers integrating ANNA-B112 in their designs.

Grade	ANNA-B112	
Automotive		
Professional	•	
Standard		
Radio	ANNA-B112	
Chip inside	nRF52832	
Bluetooth qualification	v5.0	
Bluetooth low energy	•	
Bluetooth output power EIRP [dBm] *	5 / 8	
Max range [meters] *	160 / 190	
NFC	•	
Antenna type (see footnotes)	chip / pin	
Application software	ANNA-B112	
u-connectXpress	•	
Open CPU for embedded applications		•
Interfaces	ANNA-B112	
UART	1	◆
SPI		◆
I2C		◆
I2S		◆
PDM and PWM		◆
GPIO pins	11	25
AD converters [number of bits]		12
Features	ANNA-B112	
AT command interface	•	
MCU (see footnotes)		M4F
RAM [kB]		64
Flash [kB]		512
Simultaneous GATT server and client	•	◆
Low Energy Serial Port Service	•	
Throughput [Mbit/s]	0.8	1.4
Maximum Bluetooth connections	7	20
Bluetooth mesh		◆
FOTA		◆

* = The different values are for use with internal/external antenna

◆ = Feature enabled by HW. The actual support depends on the open CPU application SW.

pin = Antenna pin
chip = Internal chip antenna
M4F = 64 MHz Arm® Cortex-M4 with FPU



Features

Bluetooth	v5.0 (Bluetooth low energy)
NFC	NFC-A tag support
Range	160 m with internal antenna 190 m with external antenna
Max. output power	4 dBm conducted 5 dBm with internal antenna 8 dBm with external antenna
Receiver sensitivity	-91 dBm conducted -92 dBm with internal antenna -95 dBm with external antenna

u-connectXpress software

This section describes features of ANNA-B112 when used with the embedded u-connectXpress software. ANNA-B112 is delivered with this software and the module is configured using AT commands.

Software features	u-blox Low Energy Serial Port Service (SPS); GATT server and client via AT commands; Configuration over air; Extended Data Mode (EDM) protocol for simultaneous AT commands and data, and multiple simultaneous data streams; beacons; NFC tag for pairing and data
HW interfaces	UART, 11 x GPIO pins, NFC tag for pairing
Configuration	AT Commands
Support tools	s-center
Operating modes	Central role (7 simultaneous links) Peripheral role Simultaneous central and peripheral roles (7 simultaneous links) LE 1M PHY LE 2M PHY Advertising Extensions LE Data Length Extension
Security	Secure Simple Pairing 128-bit AES encryption LE secure connections
Throughput	780 kbps

Open CPU for customer application

Customers can develop and embed their own application on top of the Bluetooth stack and software inside the ANNA-B112 module (open CPU concept). This section describes features specific to using ANNA-B112 with open CPU. Many software features are already available via Arm Mbed or Nordic SDK environment, and more are added continuously.

Development environment	Nordic SDK (including Bluetooth Mesh, HomeKit, AirFuel, IoT); Arm Mbed 5; Wirepas Mesh (for large scale mesh networking)
Memory	512 kB flash, 64 kB RAM
HW interfaces*	NFC tag for pairing 3 x SPI 25 x GPIO pins 8 x ADC channels 12 x PWM UART 2 x I2C I2S PDM QDEC
Security	Secure Simple Pairing 128-bit AES encryption LE secure connections

* Not all simultaneously

Package

Dimensions	6.5 x 6.5 x 1.2 mm
Weight	0.1 g
Mounting	Machine mountable Solder pins

Environmental data, quality & reliability

Operating temperature	-40 °C to +85 °C
Storage temperature	-40 °C to +85 °C
Humidity	RH 5-90% non-condensing

Electrical data

Power supply	1.7 V to 3.6 VDC
Power consumption	Active TX @ 0 dBm: 5.3 mA Standby: 2.2 µA with external LPO Sleep: 300 nA (with wake-up on external event)

Certifications and approvals

Type approvals	Europe (ETSI RED); US (FCC/CFR 47 part 15 unlicensed modular transmitter approval); Canada (ISED RSS); Japan (MIC); Taiwan (NCC); South Korea (KCC); Australia / New Zealand (ACMA); Brazil (Anatel); South Africa (ICASA)
Health and safety	EN 62479, EN 60950-1, IEC 60950-1
Bluetooth qualification	v5.0 (Bluetooth low energy)

Support products

The evaluation kits include an ANNA-B112 module on an evaluation board, with access to all module pins at connectors, and built-in debugging capabilities. It can be used either with the ready-to-use u-connectXpress software or with open CPU, where the customer application is developed using a software development kit such as Nordic nRF52 SDK, Arm Mbed, or Wirepas Mesh software.

EVK-ANNA-B112C	Evaluation kit for ANNA-B112 module using the internal antenna, with module placed in the corner of the PCB
EVK-ANNA-B112U	Evaluation kit for ANNA-B112 module using the antenna pin, with an external antenna connected via a U.FL connector

Product variants

ANNA-B112	With internal antenna and antenna pin
-----------	---------------------------------------

The modules are shipped with the u-connectXpress software and can be re-flashed with customer application (open CPU).



NINA-B1 series

Stand-alone Bluetooth 5 low energy modules with NFC

Feature rich Bluetooth 5 low energy with most worldwide certifications

- Bluetooth 5 and Bluetooth mesh
- u-connect software for accelerated time to market
- Open CPU for customer applications
- Hardware optimized for performance and low power consumption
- Pin compatible with other NINA modules
- Multiple antenna options

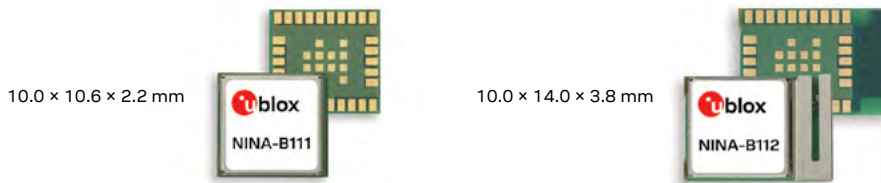

Product description

The NINA-B1 series modules are small, stand-alone Bluetooth low energy modules featuring Bluetooth 5, a powerful Arm® Cortex®-M4 with FPU, and state-of-the-art power performance. The embedded low power crystal in NINA-B1 minimizes power consumption, thus extending the battery life.

The NINA-B1 is delivered with u-connectXpress software that provides support for u-blox Bluetooth low energy Serial Port Service, GATT client and server, beacons, NFC™, and simultaneous peripheral and central roles – all configurable from a host by using AT commands.

NINA-B1 offers full flexibility for customers who prefer their application to run on the built-in Arm Cortex-M4 with FPU. With 512 kB flash and 64 kB RAM, it offers the best-in-class capacity for customer applications running on top of the Bluetooth low energy stack using SDK from Nordic Semiconductor or Arm Mbed. Additionally, NFC and interfaces such as SPI, I²C, and I²S are available, and features like Bluetooth mesh, AirFuel, and Apple HomeKit are also supported. In combination with Wirepas Connectivity stack, NINA-B1 can form large scale industrial mesh networks for several applications, such as lighting, asset tracking, and metering.

NINA-B112 comes with an internal antenna and NINA-B111 has a pin for use with an external antenna. The internal PIFA antenna is specifically designed for the small NINA-B1 form factor and provides an extensive range of more than 300 m, independent of ground plane and component placement.

The NINA-B1 series is globally certified for use with the internal antenna or a range of external antennas. This reduces time and effort for customers integrating NINA-B1 in their designs.

	NINA-B111		NINA-B112	
Grade				
Automotive				
Professional		•		•
Standard				
Radio				
Chip inside	nRF52832			
Bluetooth qualification	v5.0		v5.0	
Bluetooth low energy		•		•
Bluetooth output power EIRP [dBm]	7		6	
Max range [meters]	350		300	
NFC		•		•
Antenna type (see footnotes)	pin		metal	
Application software				
u-connectXpress		•		•
Open CPU for embedded applications		•		•
Interfaces				
UART	1	◆	1	◆
SPI		◆		◆
I ² C		◆		◆
I ² S		◆		◆
PDM and PWM		◆		◆
GPIO pins	7	19	7	19
AD converters [number of bits]		12		12
Features				
AT command interface		•		•
MCU (see footnotes)		M4F		M4F
RAM [kB]		64		64
Flash [kB]		512		512
Simultaneous GATT server and client		•		•
Low Energy Serial Port Service		•		•
Throughput [Mbit/s]	0.8	1.4	0.8	1.4
Maximum Bluetooth connections	7	20	7	20
Bluetooth mesh		◆		◆
FOTA		◆		◆

pin = Antenna pin
metal = Internal metal PIFA antenna

◆ = Feature enabled by HW. The actual support depends on the open CPU application SW. M4F = 64 MHz Arm® Cortex-M4 with FPU



Features

Bluetooth	v5.0 (Bluetooth low energy)
NFC	NFC-A tag support
Range	NINA-B111: 350 m, antenna pin reference design with 1/2 wave antenna NINA-B112: 300 m, internal antenna
Max. conducted output power	4 dBm
Max. radiated output power (EIRP)	7 dBm with approved antennas
Receiver sensitivity	NINA-B111: -95 dBm Conducted (-98 dBm with approved antennas) NINA-B112: -97 dBm

u-connectXpress software

This section describes the NINA-B1 features when used with the embedded u-connectXpress software. All NINA-B1 modules are delivered with this software and the module is configured using AT commands.

Software features	u-blox Low Energy Serial Port Service (SPS); GATT server and client via AT commands; Configuration over air; Extended Data Mode (EDM) protocol for simultaneous AT commands and data, and multiple simultaneous data streams; beacons; NFC tag for pairing and data
HW interfaces	UART, 7 x GPIO pins
Configuration	AT Commands
Support tools	s-center
Operating modes	Central role (7 simultaneous links) Peripheral role Simultaneous central and peripheral roles (7 simultaneous links) LE 1M PHY LE 2M PHY Advertising Extensions LE Data Length Extension
Security	Secure Simple Pairing 128-bit AES encryption LE secure connections
Throughput	780 kbps

Open CPU for customer application

Customers can develop and embed their own application on top of the Bluetooth stack and software inside the NINA-B1 module (open CPU concept). This section describes features specific to using NINA-B1 with an open CPU. Many software features are already available via Arm Mbed or Nordic SDK environment, and more are added continuously.

Development environment	Nordic SDK (including Bluetooth Mesh HomeKit, AirFuel, IoT); Arm Mbed 5; Wirepas connectivity software (for large scale mesh networking)	
HW interfaces*	NFC tag for pairing 3 x SPI 19 x GPIO pins 8 x ADC channels 12 x PWM	UART 2 x I2C I2S PDM QDEC
Security	Secure Simple Pairing 128-bit AES encryption LE secure connections	

* Not all simultaneously

Package

Dimensions	NINA-B111: 10.0 x 10.6 x 2.2 mm NINA-B112: 10.0 x 14.0 x 3.8 mm
Weight	< 1.0 g
Mounting	Machine mountable Solder pins

Environmental data, quality & reliability

Operating temperature	-40 °C to +85 °C
Storage temperature	-40 °C to +85 °C
Humidity	RH 5-90% non-condensing

Electrical data

Power supply	1.7 V to 3.6 VDC
Power consumption	Active TX @ 0 dBm: 5.3 mA Standby: 2.2 µA Sleep: 300 nA (with wake-up on external event)

Certifications and approvals

Type approvals	Europe (ETSI RED); US (FCC/CFR 47 part 15 unlicensed modular transmitter approval); Australia (ACMA); New Zealand; Brazil (Anatel); Canada (IC RSS); Japan (MIC - formerly TELEC); South Africa (ICASA); South Korea (KCC); Taiwan (NCC)
Health and safety	EN 62479, EN 60950-1, IEC 60950-1
Medical Electrical Equipment	EN 60601-1-2
Bluetooth qualification	v5.0 (Bluetooth low energy)

Support products

The evaluation kits include a NINA-B1 module on an evaluation board with built-in debugging capabilities. To be used with Nordic SDK or Arm Mbed as a development kit or with s-center to evaluate the u-connectXpress software. A blueprint is available on request, which includes a NINA-B1 module, a sensor, LEDs, buttons, and the source code for NINA-B1 and smart phones.

EVK-NINA-B111	Evaluation kit for NINA-B111 module with antenna pin and external antenna
EVK-NINA-B112	Evaluation kit for NINA-B112 module with internal antenna

Product variants

NINA-B111	With antenna pin
NINA-B112	With internal antenna

Modules are shipped with the u-connectXpress software and can be re-flashed with customer application (open CPU).



BMD-30 / BMD-35 series

Stand-alone Bluetooth 5 low energy modules

Bluetooth 5 solution

- Powerful, ultra-efficient 64 MHz 32-bit Arm® Cortex®-M4 with FPU, 512 kB Flash, and 64 kB RAM
- Over-the-air updates with Nordic DFU
- Extensive set of country approvals for a world-wide target market
- BMD-300 and BMD-301 are footprint compatible with BMD-330, BMD-360, and BMD-34 series

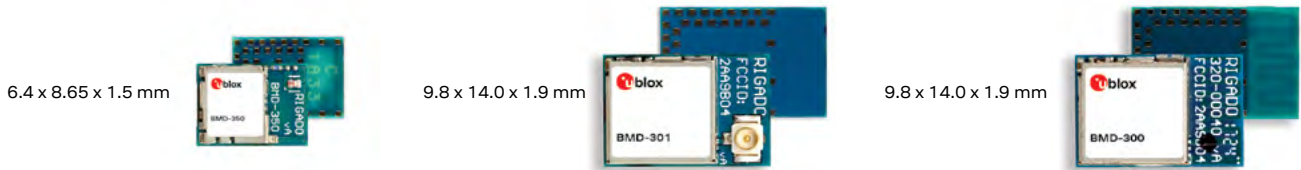

Product description

The BMD-30 / BMD-35 series are powerful, highly flexible, ultra-low power Bluetooth low energy modules based on the nRF52832 SoC from Nordic Semiconductor. With an Arm® Cortex®-M4 with FPU, embedded 2.4G Hz multi-protocol transceiver, and an integrated antenna, the BMD-30 / BMD-35 series modules provide a complete RF solution allowing faster time-to-market with reduced development costs. The BMD-301 adds antenna flexibility with a U.FL connector while the BMD-350 has the smallest footprint, including the integrated antenna.

Providing full use of the nRF52832's capabilities and peripherals, the BMD-30 / BMD-35 series modules can power the most demanding applications, all while simplifying designs and reducing BOM costs. With an internal DC-DC converter and intelligent power control, the BMD-30 series provides class-leading power efficiency, enabling ultra-low power sensitive applications. Carrying FCC, IC, and CE certifications, Bluetooth qualification, and a wide range of other country approvals, the modules are ready to implement right away for a world wide market.

BMD-300 and BMD-301 designs are footprint compatible with the BMD-330, BMD-360 and BMD-34 series modules, thus providing flexibility for tiered product lineups.

	BMD-350	BMD-301	BMD-300
Grade			
Automotive			
Professional			
Standard	•	•	•
Radio			
Chip inside	nRF52832		
Bluetooth qualification	v5.0	v5.0	v5.0
Bluetooth low energy	•	•	•
Thread / Zigbee			
Bluetooth output power EIRP [dBm]	5	9	3
Max range [meters]	190	400	200
NFC	•	•	•
Antenna type (see footnotes)	chip	U.FL	pcb
Application software			
Open CPU for embedded applications	•	•	•
Interfaces			
UART	♦	♦	♦
SPI	♦	♦	♦
I2C	♦	♦	♦
I2S	♦	♦	♦
USB			
PDM and PWM	♦	♦	♦
GPIO pins	32	32	32
AD converters [number of bits]	12	12	12
Features			
MCU (see footnotes)	M4F	M4F	M4F
RAM [kB]	64	64	64
Flash [kB]	512	512	512
Simultaneous GATT server and client	♦	♦	♦
Throughput [Mbit/s]	1.4	1.4	1.4
Maximum Bluetooth connections	20	20	20
Secure boot			
Bluetooth mesh	♦	♦	♦
FOTA	♦	♦	♦

pcb = Internal PCB antenna
 chip = Internal chip antenna
 U.FL = U.FL antenna connector
 M4F = 64 MHz Arm® Cortex®-M4 with FPU

♦ = Feature enabled by HW. The actual support depends on the open CPU application SW.



Features

Bluetooth	v5.0 (Bluetooth low energy)
NFC	NFC-A tag support
Range	BMD-350: 190 m BMD-301: 400 m BMD-300: 200 m
Max. conducted output power	BMD-350: 4 dBm BMD-301: 4 dBm BMD-300: 4 dBm
Conducted sensitivity (Bluetooth mode)	-96 dBm (1 Mbit/s)
Bluetooth address	Unique public Bluetooth address provided (in flash, on label)
Bluetooth operating modes	Simultaneous central and peripheral roles LE 2M PHY (2 Mbps) LE 1M PHY (1 Mbps) Advertising Extensions LE Data Length Extension Channel Selection Algorithm #2
Antenna	BMD-350: Internal chip antenna BMD-301: U.FL antenna connector BMD-300: Internal PCB antenna
Development environment	Nordic SDK (including Bluetooth Mesh HomeKit, AirFuel, IoT) Customers develop and embed their own application on top of the Bluetooth stack in the BMD-30 modules (open CPU concept)
Security	Secure Simple Pairing 128-bit AES encryption Bluetooth low energy secure connections

Interfaces and peripherals*

UART	1 block. 1200 baud to 1 M baud, parity, CTS and RTS support
SPI Master	3 blocks. 125 kHz to 8 Mhz clock rates
SPI Slave	3 blocks. 125 kHz to 8 Mhz clock rates
TWI (I2C) Master	2 blocks. 100 kHz to 400 kHz clock rates
TWI (I2C) Slave	2 blocks. 100 kHz to 400 kHz clock rates
PDM	1 block. 2 microphones (left/right) 16 kHz sample rate, 16-bit
I2S	1 block. Master and slave, bidirectional
ADC	8-ch, 12-bit @ 200 ksps
PWM	3 blocks, 4 channels each
LP Comparator	8-ch, VCC, int and ext ref, 15 levels
GP Comparator	8-ch, VCC and internal ref, 64 levels
Temp. Sensor	Internal, -40 °C to 85 °C, +/- 4 °C, 0.25 °C resolution
GPIO	32 GPIOs; Input High: 0.7 x VCC; Input Low: 0.3 x VCC; 13 kΩ pull-up/pull-down
Timers	5 x 32-bit and 3 x 24-bit RTC with 12-bit prescaler, watchdog

* Not all simultaneously

Package

Dimensions	9.8 x 14.0 x 1.9 mm (BMD-300, BMD-301) 6.4 x 8.65 x 1.5 mm (BMD-350)
Weight	< 1.0 g
Mounting	Machine mountable Solder pins

Environmental data, quality & reliability

Operating temperature	-40 °C to +85 °C
Storage temperature	-40 °C to +125 °C
Humidity	RH 5 – 90% non-condensing
RoHS	RoHS 3 compliant

Electrical data

Power supply	1.7 VDC to 3.6 VDC
Power consumption in Bluetooth low energy mode	Active TX @ 0 dBm: 5.3 mA No RAM retention: 0.4 µA at 3 V No RAM retention, wake on RTC: 1.5 µA at 3 V

Certifications and approvals

Type approvals	BMD-350: US (FCC); Canada (IC/ISED); Europe (ETSI RED); Japan (MIC); South Korea (KCC); Australia & New Zealand (RCM); Brazil (ANATEL); Mexico (IFETEL); Eurasia (EAC); China (SRRC) BMD-301: US (FCC); Canada (IC/ISED); Europe (ETSI RED); Japan (MIC); Australia & New Zealand (RCM) BMD-300: US (FCC); Canada (IC/ISED); Europe (ETSI RED); Japan (MIC); South Korea (KCC); Australia & New Zealand (RCM); Brazil (ANATEL); Mexico (IFETEL)
Health and safety	EN 62479, EN 60950-1, IEC 60950-1
Bluetooth qualification	v5.0 (Bluetooth low energy), Bluetooth RF PHY

Support products

BMD-350-Eval	Evaluation kit for BMD-350 with open CPU and internal chip antenna
BMD-301-Eval	Evaluation kit for BMD-301 with open CPU and U.FL antenna connector
BMD-300-Eval	Evaluation kit for BMD-300 with open CPU and internal PCB antenna

Product variants

BMD-350	With internal chip antenna, open CPU
BMD-301	With U.FL connector, open CPU
BMD-300	With internal PCB antenna, open CPU



NINA-B30 series

Stand-alone Bluetooth 5 low energy modules

Full Bluetooth 5 with powerful MCU and worldwide certifications

- Full Bluetooth 5, Bluetooth mesh, 802.15.4 Thread, and Zigbee
- Powerful open CPU for advanced customer applications
- Hardware optimized for performance and low power consumption
- Pin compatible with other NINA modules
- Superior security functionality
- Multiple antenna options

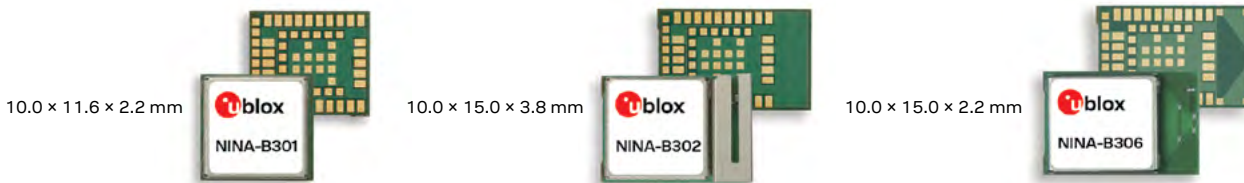

Product description

The NINA-B30 series are small, stand-alone Bluetooth low energy microcontroller unit (MCU) modules. NINA-B30 features full Bluetooth 5, a powerful Arm® Cortex®-M4 with FPU, and state-of-the-art power performance. The embedded low power crystal in NINA-B30 improves the power consumption by enabling optimal power save modes.

Both variants are open CPU modules that enable customer applications to run on the built-in Arm Cortex-M4 with FPU. With 1 MB flash and 256 kB RAM, they offer the best-in-class capacity for customer applications on top of the Bluetooth low energy stack. Applications can include Bluetooth low energy services such as GATT, beacons, and mesh. Additionally, the modules support NFC™, 802.15.4 with Thread and ZigBee. The modules have a range of wired interfaces, including UART, SPI, I2C, I2S, USB, QDEC, PDM, PWM, and ADC.

NINA-B30 caters to applications in smart buildings, smart cities, and the Industry 4.0, including smart lighting systems, industrial sensor networks, asset tracking solutions, and building automation systems.

NINA-B302 comes with an internal PIFA antenna, NINA-B306 comes with an internal PCB antenna, while NINA-B301 has a pin for use with an external antenna. The internal PIFA antenna is specifically designed for the small NINA form factor and provides an extensive range, independent of ground plane and component placement. The internal PCB antenna provides a robust low profile solution with high performance.

The NINA-B30 series is globally certified for use with the internal antenna or a range of external antennas. This greatly reduces time, cost, and effort for customers integrating NINA-B30 in their designs.

NINA-B301
NINA-B302
NINA-B306

	NINA-B301	NINA-B302	NINA-B306
Grade			
Automotive			
Professional	•	•	•
Standard			
Radio			
Chip inside	nRF52840		
Bluetooth qualification	v5.0	v5.0	v5.0
Bluetooth low energy	•	•	•
Thread / Zigbee	•	•	•
Bluetooth output power EIRP [dBm]	10	10	10
Max range [meters]	1400	1400	1400
NFC	•	•	•
Antenna type (see footnotes)	pin	metal	pcb
Application software			
Open CPU for embedded customer applications	•	•	•
Interfaces			
UART	◆	◆	◆
SPI	◆	◆	◆
I2C	◆	◆	◆
I2S	◆	◆	◆
USB	◆	◆	◆
PDM and PWM	◆	◆	◆
GPIO pins	38	38	38
AD converters [number of bits]	12	12	12
Features			
MCU (see footnotes)	M4F	M4F	M4F
RAM [kB]	256	256	256
Flash [kB]	1024	1024	1024
Simultaneous GATT server and client	◆	◆	◆
Throughput [Mbit/s]	1.4	1.4	1.4
Maximum Bluetooth connections	20	20	20
Secure boot	◆	◆	◆
Bluetooth mesh	◆	◆	◆
FOTA	◆	◆	◆

pin = Antenna pin
pcb = Internal PCB antenna
metal = Internal metal PIFA antenna

◆ = Feature enabled by HW. The actual support depends on the open CPU application SW.
M4F = 64 MHz Arm® Cortex-M4 with FPU



Features

Bluetooth	v5.0 (Bluetooth low energy)
NFC	NFC-A tag support
Range	1400 m
Max. conducted output power	8 dBm
Conducted sensitivity	-94 dBm (1 Mbit/s) -100 dBm (125 Kbit/s)

Open CPU for customer application

Customers develop and embed their own application on top of the Bluetooth stack in the NINA-B30x modules (open CPU concept). This section describes the possible features enabled by the NINA-B30 hardware. Use Nordic Semiconductor's SDK environment to develop the connectivity and application software.

Development environment	Nordic SDK (including Bluetooth Mesh, HomeKit, AirFuel, IoT)
HW interfaces *	2 x UART 3 x SPI 38 x GPIO pins 8 x ADC channels 12 x PWM 1 x USB 2 x I2C 1 x I2S 1 x PDM 1 x QDEC
Security	Secure boot Secure Simple Pairing 128-bit AES encryption BLE secure connections

* Not all simultaneously

Electrical data

Power supply	1.7 VDC to 3.6 VDC
Power consumption in Bluetooth LE mode	Active TX @ 0 dBm: 4.9 mA Standby: 1.3 μ A Sleep: 400 nA (with wake-up on external event)

Package

Dimensions	NINA-B301: 10.0 x 11.6 x 2.2 mm NINA-B302: 10.0 x 15.0 x 3.8 mm NINA-B306: 10.0 x 15.0 x 2.2 mm
Weight	< 1.0 g
Mounting	Machine mountable Solder pins

Environmental data, quality & reliability

Operating temperature	-40 °C to +85 °C
Storage temperature	-40 °C to +85 °C
Humidity	RH 5 – 90% non-condensing

Certifications and approvals

Type approvals	Europe (ETSI RED); US (FCC/CFR 47 part 15 unlicensed modular transmitter approval); Canada (IC RSS); Japan (MIC); Taiwan (NCC); Australia (ACMA); New Zealand; Brazil (Anatel); South Korea (KCC); South Africa (ICASA) ¹
Health and safety	EN 62479, EN 60950-1, IEC 60950-1
Bluetooth qualification	v5.0 (Bluetooth Low Energy)

1 = Pending approval

Support products

EVK-NINA-B301	Evaluation kit for NINA-B301 module with open CPU and antenna pin
EVK-NINA-B302	Evaluation kit for NINA-B302 module with open CPU and internal PIFA antenna
EVK-NINA-B306	Evaluation kit for NINA-B306 with open CPU and internal PCB antenna

Product variants

NINA-B301	With open CPU and antenna pin
NINA-B302	With open CPU and internal PIFA antenna
NINA-B306	With open CPU and internal PCB antenna

NINA-B31 series

Stand-alone Bluetooth 5 low energy modules

Full Bluetooth 5 made easy and with worldwide certifications

- Full Bluetooth 5 with long range
- u-connect software for accelerated time to market
- Hardware optimized for performance and low power consumption
- Pin compatible with other NINA modules
- Superior security functionality with built-in secure boot
- Multiple antenna options

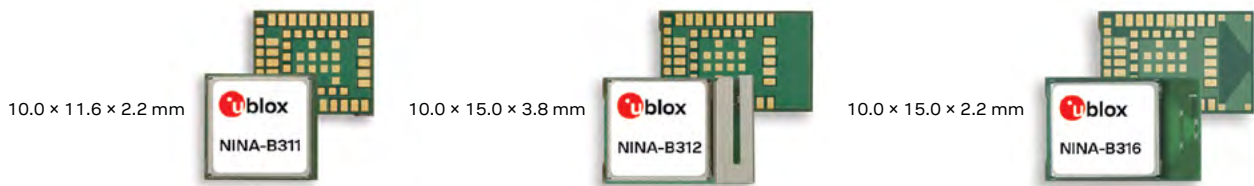

Product description

The NINA-B31 series are small, stand-alone Bluetooth low energy wireless microcontroller unit (MCU) modules. NINA-B31 features full Bluetooth 5, a powerful Arm® Cortex®-M4 with FPU, and state-of-the-art power performance. The embedded low power crystal in NINA-B31 improves the power consumption by enabling optimal power save modes. The NINA-B31 modules are delivered with u-connect software, providing support for u-blox Bluetooth low energy Serial Port Service, GATT client and server, beacons, NFC™, and simultaneous peripheral and central roles. Two variants of the u-connect software are available: u-connectXpress that provides support for a host to easily configure connectivity using AT commands, and u-connectScript that allows an application to be embedded on the module using JavaScript.

The NINA-B31 modules provide top grade security, thanks to secure boot, which ensures the module only boots up with original u-blox u-connect software. NINA-B31 caters to applications in smart buildings, smart cities, and the Industry 4.0, including smart lighting systems, industrial sensor networks, asset tracking solutions, and building automation systems.

NINA-B312 comes with an internal PIFA antenna, NINA-B316 comes with an internal PCB antenna, while NINA-B311 has a pin for use with an external antenna. The internal PIFA antenna is specifically designed for the small NINA form factor and provides an extensive range, independent of ground plane and component placement. The internal PCB antenna provides a robust low profile solution with high performance.

The NINA-B31 series is globally certified for use with the internal antenna or a range of external antennas. This greatly reduces time, cost, and effort for customers integrating NINA-B31 in their designs.

	NINA-B311	NINA-B312	NINA-B316
Grade			
Automotive			
Professional	•	•	•
Standard			
Radio			
Chip inside	nRF52840		
Bluetooth qualification	v5.0	v5.0	v5.0
Bluetooth low energy	•	•	•
Bluetooth output power EIRP [dBm]	10	10	10
Max range [meters]	1400	1400	1400
NFC	•	•	•
Antenna type (see footnotes)	pin	metal	pcb
Application software			
u-connectXpress	•	•	•
u-connectScript	•	•	
Interfaces			
UART	2	2	2
I2C	•	•	•
GPIO pins	28	28	28
Features			
AT command interface	•	•	•
Script engine – JavaScript	•	•	
Simultaneous GATT server and client	•	•	•
Low Energy Serial Port Service	•	•	•
Throughput [Mbit/s]	0.8	0.8	0.8
Maximum Bluetooth connections	8	8	8
Secure boot	•	•	•
Bluetooth mesh	•	•	•

pin = Antenna pin
pcb = Internal PCB antenna

metal = Internal metal PIFA antenna



Features

Bluetooth	v5.0 (Bluetooth Low Energy)
NFC	NFC-A tag support
Range	1400 m
Max. conducted output power	8 dBm
Conducted sensitivity	-94 dBm (1 Mbit/s) -100 dBm (125 Kbit/s)

u-connectXpress software

This section describes the NINA-B31 u-connectXpress software features. More features will be available via software updates.

Software features	u-blox Low Energy Serial Port Service (SPS); GATT server and client via AT commands; Configuration over air; Extended Data Mode (EDM) protocol for simultaneous AT commands and data, and multiple simultaneous data streams; beacons; NFC tag for pairing and data; 2 Mbit/s modulation; 125 and 500 Kbit/s modulation for long range functionality; Advertisement extensions
HW interfaces	UART, GPIO
Configuration	AT Commands
Support tools	s-center
Simultaneous connections	8
Security	Secure boot Secure Simple Pairing 128-bit AES encryption
Throughput over UART	780 Kbit/s

u-connectScript software

This section describes the NINA-B31 u-connectScript software features. More features will be available via software updates.

Software features	Embedded script engine; u-connect streams supporting u-blox Low Energy Serial Port Service (SPS) and I2C interface for connecting sensors; GATT server; Scanning and custom advertisement (beacons); 2 Mbit/s modulation; 125 and 500 Kbit/s modulation for long range functionality; Advertisement extensions; Power save mode
Programming language	JavaScript
Development environment	Microsoft Visual Studio Code u-blox Script IDE
Memory	Available Flash file system 85 kB Available RAM application 40 kB
Hardware interfaces	UART, GPIO, I2C
Simultaneous connections	1
Security	Secure boot Just Works™

Package

Dimensions	NINA-B311: 10.0 x 11.6 x 2.2 mm NINA-B312: 10.0 x 15.0 x 3.8 mm NINA-B316: 10.0 x 15.0 x 2.2 mm
Weight	< 1.0 g
Mounting	Machine mountable Solder pins

Environmental data, quality & reliability

Operating temperature	-40 °C to +85 °C
Storage temperature	-40 °C to +85 °C
Humidity	RH 5 – 90% non-condensing

Electrical data

Power supply	1.7 VDC to 3.6 VDC
Power consumption in Bluetooth LE mode	Active TX @ 0 dBm: 4.9 mA Standby: 1.3 µA Sleep: 400 nA (with wake-up on external event)

Certifications and approvals

Type approvals	Europe (ETSI RED); US (FCC/CFR 47 part 15 unlicensed modular transmitter approval); Canada (IC RSS); Japan (MIC); Taiwan (NCC); Australia (ACMA); New Zealand; Brazil (Anatel); South Korea (KCC); South Africa (ICASA) ¹
Health and safety	EN 62479, EN 60950-1, IEC 60950-1
Bluetooth qualification	v5.0 (Bluetooth low energy)

¹ = Pending approval

Support products

EVK-NINA-B311	Evaluation kit for NINA-B311 module with u-connect software and antenna pin
EVK-NINA-B312	Evaluation kit for NINA-B312 module with u-connect software and internal PIFA antenna
EVK-NINA-B316	Evaluation kit for NINA-B316 module with u-connect software and internal PCB antenna

Product variants

The NINA-B31 variants come with pre-flashed u-connect software.

NINA-B311 (u-connectXpress)	With antenna pin and u-connectXpress software
NINA-B312 (u-connectXpress)	With internal PIFA antenna and u-connectXpress software
NINA-B316 (u-connectXpress)	With internal PCB antenna and u-connectXpress software
NINA-B311 (u-connectScript)	With antenna pin and u-connectScript software
NINA-B312 (u-connectScript)	With internal PIFA antenna and u-connectScript software



BMD-34 series

Stand-alone Bluetooth 5 low energy modules

Full Bluetooth 5, Thread, and Zigbee (IEEE 802.15.4) solution

- Powerful, ultra-efficient 64 MHz 32-bit Arm® Cortex®-M4 with FPU, 1 MB Flash, and 256 kB RAM
- Bluetooth 5 long range support (Coded PHY)
- USB 2.0 and Built-in DC-DC converter for direct USB / Li-Ion power
- Hardware cryptographic unit for secure boot and over-the-air updates
- Optional PA/LNA for extreme range



Product description

The BMD-34 series are advanced, highly flexible, ultra-low-power multiprotocol modules that enable concurrent Bluetooth 5, Thread and Zigbee (IEEE 802.15.4) connectivity for portable, extremely low power embedded systems, offering the greatest radio range and coverage. With an Arm® Cortex®-M4 with FPU, integrated 2.4 GHz transceiver, an extended range of interfaces and embedded hardware cryptographic engine, the BMD-34 modules provide a complete RF solution allowing faster time to market with reduced development costs and advanced security capabilities. Providing full use of the Nordic nRF52840's capabilities and peripherals, the BMD-34 can power the most demanding applications, all while simplifying designs and reducing BOM costs.

The BMD-34 is an ideal solution for designs that require Bluetooth 5 features or 802.15.4 based networking for Thread and Zigbee. The Bluetooth 5 long range feature provides extended range, and the optional PA/LNA boost the link budget even further, bringing range and coverage to the maximum. Built in USB and 5.5 V compatible DC-DC supply reduces design complexity and BOM cost, while expanding possible applications. The modules are certified for Europe, US, Canada, and Australia/New Zealand, including antenna alternatives for either internal PCB antenna, or a U.FL antenna connector for external antenna. BMD-34 designs are footprint compatible with a range of other BMD-modules, thus providing flexibility for tiered product lineups.

	BMD-345	BMD-341	BMD-340
Grade			
Automotive			
Professional			
Standard	•	•	•
Radio			
Chip inside	nRF52840		
Bluetooth qualification	v5.0	v5.0	v5.0
Bluetooth low energy	•	•	•
Thread / Zigbee	•	•	•
Bluetooth output power EIRP [dBm]	16	13	7
Max range [meters]	1000	750	500
NFC		•	•
Antenna type (see footnotes)	U.FL	U.FL	pcb
Application software			
Open CPU for embedded applications	•	•	•
Interfaces			
UART	♦	♦	♦
SPI	♦	♦	♦
I2C	♦	♦	♦
I2S	♦	♦	♦
USB	♦	♦	♦
PDM and PWM	♦	♦	♦
GPIO pins	44	48	48
AD converters [number of bits]	12	12	12
Features			
MCU (see footnotes)	M4F	M4F	M4F
RAM [kB]	256	256	256
Flash [kB]	1024	1024	1024
Simultaneous GATT server and client	♦	♦	♦
Throughput [Mbit/s]	1.4	1.4	1.4
Maximum Bluetooth connections	20	20	20
Secure boot	♦	♦	♦
Bluetooth mesh	♦	♦	♦
FOTA	♦	♦	♦

pcb = Internal PCB antenna
 U.FL = U.FL antenna connector
 M4F = 64 MHz Arm® Cortex®-M4 with FPU

♦ = Feature enabled by HW. The actual support depends on the open CPU application SW.

Features

Bluetooth	v5.0 (Bluetooth low energy)
NFC	NFC-A tag support
Range	BMD-345: 1000 m BMD-341: 750 m BMD-340: 500 m
Max. radiated output power (EIRP)	BMD-345: 16 dBm BMD-341: 13 dBm BMD-340: 7 dBm
Conducted sensitivity (Bluetooth mode)	BMD-340, -341: -95 dBm (1 Mbit/s) -103 dBm (125 Kbit/s) BMD-345: -105 dBm (1 Mbit/s) -113 dBm (125 kbit/s)
Bluetooth address	Unique public Bluetooth address provided (in flash, on label)
Bluetooth operating modes	Simultaneous central and peripheral roles LE 2M PHY (2 Mbps) LE 1M PHY (1 Mbps) Coded PHY 500 kbps (long range) Coded PHY 125 kbps (long range) Advertising Extensions LE Data Length Extension Channel Selection Algorithm #2
Antenna	BMD-340: Integrated PCB antenna BMD-341, -345: U.FL antenna connector
Development environment	Nordic SDK (including Bluetooth Mesh HomeKit, AirFuel, IoT) Customers develop and embed their own application on top of the Bluetooth stack in the BMD-34 modules (open CPU concept)
Security	Arm® TrustZone® CryptoCell cryptographic unit Secure boot Secure Simple Pairing 128-bit AES encryption Bluetooth low energy secure connections

Interfaces and peripherals*

UART	2 blocks. 1200 baud to 1 M baud, parity, CTS and RTS support
SPI Master	4 blocks. 125 kHz to 8 Mhz clock rates
SPI Slave	3 blocks. 125 kHz to 8 Mhz clock rates
QSPI Master	1 block. Max 32 MHz. XIP support
TWI (I2C) Master	2 blocks. 100 kHz to 400 kHz clock rates
TWI (I2C) Slave	2 blocks. 100 kHz to 400 kHz clock rates
NFC	NFC-A, 13.56 MHz, 106 kbps, wake-on-field
PDM	1 block. 2 microphones (left/right) 16 kHz sample rate, 16-bit
I2S	1 block. Master and slave, bidirectional
ADC	8-ch, 12-bit @ 200 ksps
PWM	4 blocks, 4 channels each
LP Comparator	8-ch, VCC, int and ext ref, 15 levels
GP Comparator	8-ch, VCC and internal ref, 64 levels
Temp. Sensor	Internal, -40 °C to 85 °C, +/- 4 °C, 0.25 °C resolution
GPIO	BMD-340, -341: 48; BMD-345: 44 Input High: 0.7 x VCC; Input Low: 0.3 x VCC; 13 kΩ pull-up/pull-down
Timers	5 x 32-bit and 3 x 24-bit RTC with 12-bit prescaler, watchdog
USB peripheral	1 block. USB 2.0 full speed, 12 Mbps. 2 control, 14 bulk/interrupt endpoints

* Not all simultaneously

Package

Dimensions	10.2 × 15.0 × 1.9 mm
Weight	< 1.0 g
Mounting	Machine mountable Solder pins

Environmental data, quality & reliability

Operating temperature	-40 °C to +85 °C
Storage temperature	-40 °C to +125 °C
Humidity	RH 5 – 90% non-condensing
RoHS	RoHS 3 compliant

Electrical data

Power supply	BMD-340, -341: 1.7 VDC to 5.5 VDC BMD-345: 2.0 VDC to 3.6 VDC
Power consumption in Bluetooth low energy mode for BMD-340, BMD-341	TX only @ +8 dBm 14.8 mA @ 3V TX only @ 0 dBm: 4.8mA @ 3V No RAM retention: 0.4 µA at 3 V No RAM retention, wake on RTC: 1.5 µA at 3 V
Power consumption in Bluetooth low energy mode for BMD-345	TX only @ +12 dBm 90 mA @ 3V (includes current for the PA/LNA) No RAM retention: 0.7 µA @ 3V No RAM retention, wake on RTC: 2.3 µA @ 3 V

Certifications and approvals

Type approvals	Europe (ETSI RED); US (FCC/CFR 47 part 15 unlicensed modular transmitter approval); Canada (ISED RSS); Australia and New Zealand (RCM)
Health and safety	EN 62479, EN 60950-1, IEC 60950-1
Bluetooth qualification	v5.0 (Bluetooth low energy), Bluetooth RF PHY

Support products

BMD-340-Eval	Evaluation kit for BMD-340 with open CPU and internal PCB antenna
BMD-341-Eval	Evaluation kit for BMD-341 with open CPU and U.FL antenna connector
BMD-345-Eval	Evaluation kit for BMD-345 with open CPU, PA/LNA, and U.FL antenna connector

Product variants

BMD-340	With internal PCB antenna, open CPU
BMD-341	With U.FL antenna connector, open CPU
BMD-345	With U.FL antenna connector, PA/LNA, open CPU



NINA-B2 series

Stand-alone dual-mode Bluetooth modules

Secure industrial dual-mode Bluetooth made easy

- Simultaneous dual-mode Bluetooth
- u-connect software for accelerated time to market
- Built-in security with secure boot
- Small footprint and multiple antenna options
- Pin compatible with other NINA modules
- Global certification



Standard



Professional



Automotive

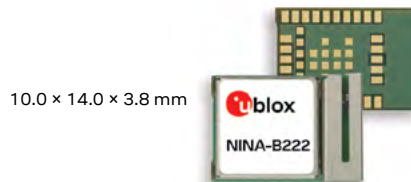
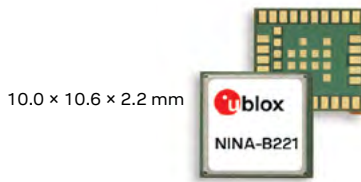

Product description

The NINA-B2 series are small, dual-mode Bluetooth stand-alone modules designed for ease-of-use and integration in professional applications. The modules are pre-flashed with u-connectXpress software that provides support for both peripheral and central roles, Serial Port Profile, GATT client and server, beacons, u-blox Bluetooth low energy Serial Port Service – all configurable from a host using AT commands. This software is easy to use and reduces the time, risk and cost to add Bluetooth connectivity to the end product.

The NINA-B2 modules provide top grade security, thanks to secure boot, which ensures the module only boots up with original u-blox software. Intended applications include industrial automation, wireless-connected and configurable equipment, point-of-sales, and health devices.

NINA-B222 comes with an internal antenna while NINA-B221 has a pin for use with an external antenna. The internal PIFA antenna is specifically designed for the small NINA form factor and provides an extensive range, independent of ground plane and component placement.

The NINA-B2 series is globally certified for use with the internal antenna or a range of external antennas. This greatly reduces time, cost and effort for customers integrating NINA-B2 in their designs.

	NINA-B221	NINA-B222
Grade		
Automotive		
Professional	•	•
Standard		
Radio		
Chip inside	ESP32	
Bluetooth qualification	v4.2	v4.2
Bluetooth low energy	•	•
Bluetooth BR/EDR	•	•
Bluetooth output power EIRP [dBm]	8	8
Max range [meters]	200	200
Antenna type	pin	metal
Application software		
u-connectXpress software	•	•
Interfaces		
UART	1	1
GPIO pins	13	13
Features		
AT command interface	•	•
Simultaneous GATT server and client	•	•
Low Energy Serial Port Service	•	•
Throughput [Mbit/s]	1.0	1.0
Maximum Bluetooth connections	7	7
Secure boot	•	•

pin = Antenna pin metal = Internal metal PIFA antenna



Features

Bluetooth	v4.2 (Bluetooth BR/EDR and Bluetooth low energy)
Range	200 m
Output power	Bluetooth low energy: 8 dBm EIRP Bluetooth BR/EDR: 8 dBm EIRP
Conducted sensitivity	-88 dBm (Bluetooth BR/EDR 1 Mbit/s) -88 dBm (Bluetooth low energy)

u-connectXpress software

This section describes the NINA-B2 features integrated in the u-connectXpress software. All NINA-B2 modules are delivered with this software and the module is configured using AT commands.

Software features	SPP profile; u-blox Low Energy Serial Port Service (SPS); GATT server and client via AT commands; Central and peripheral roles; Configuration over air; Extended Data Mode (EDM) protocol for simultaneous AT commands and data, and multiple simultaneous data streams; beacons
HW interfaces	UART, GPIO
Configuration	AT Commands
Support tools	s-center
Simultaneous connections	7
Security	Secure boot Secure Simple Pairing
Throughput	Bluetooth low energy 350 kbit/s Bluetooth BR/EDR 1.0 Mbit/s

Electrical data

Power supply	3.0 V to 3.6 V
Power consumption	Bluetooth BR/EDR Tx: 147 mA Bluetooth low energy Tx: 57 mA Idle mode: 36 mA

Package

Dimensions	NINA-B221: 10.0 x 10.6 x 2.2 mm NINA-B222: 10.0 x 14.0 x 3.8 mm
Weight	< 1.0 g
Mounting	Machine mountable Solder pins

Environmental data, quality & reliability

Operating temperature	-40 °C to +85 °C
Storage temperature	-40 °C to +85 °C
Humidity	RH 5-90% non-condensing

Certifications and approvals

Type approvals	Europe (ETSI RED), Canada (IC RSS), Taiwan (NCC), US (FCC/CFR 47 part 15 unlicensed modular transmitter approval), Japan (MIC), South Korea (KCC), Brazil (Anatel), Australia (ACMA), New Zealand, South Africa (ICASA)
Health and safety	EN 62479, EN 60950-1, IEC 60950-1
Medical Electrical Equipment	EN 60601-1-2
Bluetooth qualification	v4.2 (Bluetooth BR/EDR and Bluetooth low energy)

Support products

EVK-NINA-B221	Evaluation kit for NINA-B221 with antenna pin
EVK-NINA-B222	Evaluation kit for NINA-B222 with internal antenna

Product variants

NINA-B221	Bluetooth module with antenna pin
NINA-B222	Bluetooth module with internal antenna



BMD-330 module

Stand-alone Bluetooth 5 low energy module

Cost efficient Bluetooth 5 module

- Supports the key Bluetooth 5 features of high throughput and increased broadcast capacity
- Powerful and ultra-efficient 64 MHz 32-bit Arm® Cortex®-M4 CPU with 192 kB Flash and 24 kB RAM
- Built-in DC-DC converter for low power operation
- Footprint compatible with BMD-300/301 and BMD-360 modules

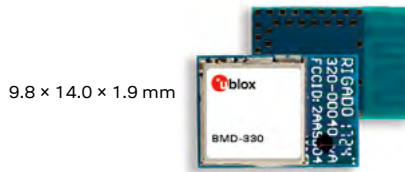

BMD-330

Grade	
Automotive	
Professional	
Standard	•
Radio	
Chip inside	nRF52810
Bluetooth qualification	v5.0
Bluetooth low energy	•
Thread / Zigbee	
Bluetooth output power EIRP [dBm]	3
Max range [meters]	200
NFC	
Antenna type (see footnotes)	pcb
Application software	
Open CPU for embedded applications	•
Interfaces	
UART	◆
SPI	◆
I2C	◆
I2S	
USB	
PDM and PWM	◆
GPIO pins	32
AD converters [number of bits]	12
Features	
MCU (see footnotes)	M4
RAM [kB]	24
Flash [kB]	192
Simultaneous GATT server and client	◆
Throughput [Mbit/s]	1.4
Maximum Bluetooth connections	4
Secure boot	
Bluetooth mesh	
FOTA	◆

pcb = Internal PCB antenna ◆ = Feature enabled by HW. The actual support depends on the open CPU application SW.
M4 = 64 MHz Arm® Cortex-M4

Product description

The BMD-330 module is a powerful, highly flexible, ultra-low power Bluetooth 5 module based on the Nordic nRF52810 SoC. Featuring a common footprint, the BMD-330 complements Rigado's BMD-3xx series lineup with an optimized peripheral set that is attractive for a wide range of cost-sensitive applications.

The BMD-330 provides a complete RF solution allowing faster time-to-market with reduced development cost and provides full use of the nRF52810's capabilities and peripherals. With an internal DC-DC converter and intelligent power control the BMD-330 provides class-leading power efficiency, enabling ultra-low power sensitive applications. Carrying FCC, IC and CE certifications and Bluetooth qualification, the BMD-330 is ready to implement right away.



Features

Bluetooth	v5.0 (Bluetooth low energy)
Range	200 m
Max. radiated output power (EIRP)	3 dBm
Conducted sensitivity	-96 dBm (1 Mbit/s, Bluetooth mode)
Bluetooth address	Unique public Bluetooth address provided (in flash, on label)
Bluetooth operating modes	Simultaneous central and peripheral roles LE 2M PHY (2 Mbps) LE 1M PHY (1 Mbps) LE Data Length Extension Channel Selection Algorithm #2
Antenna	Integrated PCB antenna
Development environment	Nordic SDK Customers develop and embed their own application on top of the Bluetooth stack in the BMD-330 modules (open CPU concept)
Security	Secure Simple Pairing 128-bit AES encryption Bluetooth low energy secure connections

Interfaces and peripherals*

UART	1 block. 1200 baud to 1 M baud, parity, CTS and RTS support
SPI master	1 block. 125 kHz to 8 Mhz clock rates
SPI Slave	1 block. 125 kHz to 8 Mhz clock rates
I2C (I2C) master/slave	1 block. 100 kHz to 400 kHz clock rates
PDM	1 block. 2 microphones (left/right) 16 kHz sample rate, 16-bit
ADC	8-ch, 12-bit @ 200 ksps
PWM	1 block, 4 channels
GP Comparator	8-ch, VCC and internal ref, 64 levels
Temp. Sensor	Internal, -40 °C to 85 °C, +/- 4 °C, 0.25 °C resolution
GPIO	32 - Input High: 0.7 x VCC; Input Low: 0.3 x VCC; 13 kΩ pull-up/pull-down
Timers	3 x 32-bit and 2 x 24-bit RTC with 12-bit prescaler, watchdog

* Not all simultaneously

Package

Dimensions	9.8 x 14.0 x 1.9 mm
Weight	< 1.0 g
Mounting	Machine mountable Solder pins

Environmental data, quality & reliability

Operating temperature	-40 °C to +85 °C
Storage temperature	-40 °C to +85 °C
Humidity	RH 5 – 90% non-condensing
RoHS	RoHS 3 compliant

Electrical data

Power supply	1.7 VDC to 3.6 VDC
Power consumption in Bluetooth low energy mode	Active TX @ 0 dBm: 4.6 mA Full RAM retention, wake on RTC: 1.5 µA No RAM retention, wake on RTC: 1.4 µA Sleep, full RAM retention: 500 nA Sleep, no RAM retention: 300 nA

Certifications and approvals

Type approvals	Europe (ETSI RED); US (FCC/CFR 47 part 15 unlicensed modular transmitter approval); Canada (ISED RSS); Australia and New Zealand (RCM)
Health and safety	EN 62479, EN 60950-1, IEC 60950-1
Bluetooth qualification	v5.0 (Bluetooth low energy), Bluetooth RF PHY

Support products

BMD-330-Eval	Evaluation kit for BMD-330 with open CPU and internal PCB antenna
--------------	---

Product variants

BMD-330	With internal PCB antenna, open CPU
---------	-------------------------------------



BMD-360 module

Stand-alone Bluetooth 5.1 low energy module

Cost efficient Bluetooth 5.1 including long range and direction finding

- Bluetooth v5.1 with direction finding (AoA/AoD) for location tags
- Bluetooth long range support (Coded PHY) for extended range and coverage
- 802.15.4, Thread, and Zigbee
- Powerful, ultra-efficient 64 MHz 32-bit Arm® Cortex®-M4 CPU with 192 kB Flash and 24 kB RAM
- Footprint compatible with BMD-300/301 and BMD-330 modules

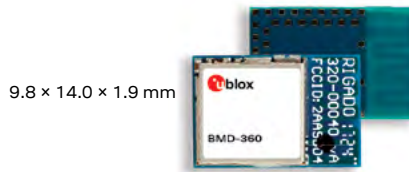

Product description

The BMD-360 module is a highly flexible, ultra-low power multiprotocol module supporting Bluetooth 5.1, including Bluetooth direction finding and the Bluetooth long range feature. The module is based on the Nordic Semiconductor nRF52811, providing an interface set and memory size optimized for cost-sensitive applications.

Together with the integrated 64 MHz 32-bit Arm® Cortex®-M4 CPU and the integrated antenna, the BMD-360 is an ideal solution for the tag side of designs that require Bluetooth 5.1 direction finding solutions (AoA - Angle of Arrival and AoD - Angle of Departure), or long range beacon designs.

In addition to Bluetooth, the BMD-360 also concurrently supports 802.15.4 such as Thread and Zigbee. The module provides a complete RF solution allowing for faster time-to-market with reduced development cost, and the module certifications for Europe, US, Canada and Australia/New Zealand further simplifies the integration. BMD-360 designs are footprint compatible with a range of other BMD-modules, thus providing full flexibility for tiered product lineups.

BMD-360

Grade	
Automotive	
Professional	
Standard	•
Radio	
Chip inside	nRF52811
Bluetooth qualification	v5.1
Bluetooth low energy	•
Thread / Zigbee	•
Bluetooth output power EIRP [dBm]	3
Max range [meters]	200
NFC	
Antenna type (see footnotes)	pcb
Application software	
Open CPU for embedded applications	•
Interfaces	
UART	◆
SPI	◆
I2C	◆
I2S	
USB	
PDM and PWM	◆
GPIO pins	32
AD converters [number of bits]	12
Features	
MCU (see footnotes)	M4
RAM [kB]	24
Flash [kB]	192
Simultaneous GATT server and client	◆
Throughput [Mbit/s]	1.4
Maximum Bluetooth connections	4
Secure boot	
Bluetooth mesh	
FOTA	◆

pcb = Internal PCB antenna ◆ = Feature enabled by HW. The actual support depends on the open CPU application SW.
M4 = 64 MHz Arm® Cortex®-M4



Features

Bluetooth	v5.1 (Bluetooth low energy)
Range	200 m
Max. radiated output power (EIRP)	3 dBm
Conducted sensitivity (Bluetooth mode)	-97 dBm (1 Mbit/s) -104 dBm (125 Kbit/s)
MAC address	Unique MAC address provided (in flash, on label)
Bluetooth operating modes	Direction finding support for tag side Simultaneous central and peripheral roles LE 2M PHY (2 Mbps) LE 1M PHY (1 Mbps) Coded PHY 500 kbps (long range) Coded PHY 125 kbps (long range) Advertising Extensions LE Data Length Extension Channel Selection Algorithm #2
Antenna	Integrated PCB antenna
Development environment	Nordic SDK Customers develop and embed their own application on top of the Bluetooth stack in the BMD-360 modules (open CPU concept)
Security	Secure Simple Pairing 128-bit AES encryption Bluetooth low energy secure connections

Interfaces and peripherals*

UART	1 block. 1200 baud to 1 M baud, parity, CTS and RTS support
SPI master/slave	2 blocks. 125 kHz to 8 Mhz clock rates
I2C (I2C) master/slave	1 block. 100 kHz to 400 kHz clock rates
PDM	1 block. 2 microphones (left/right) 16 kHz sample rate, 16-bit
ADC	8-ch, 12-bit @ 200 ksps
PWM	1 block, 4 channels
GP comparator	8-ch, VCC and internal ref, 64 levels
Temp. sensor	Internal, -40 °C to 85 °C, +/- 4 °C, 0.25 °C resolution
GPIO	32 - Input High: 0.7 x VCC; Input Low: 0.3 x VCC; 13 kΩ pull-up/pull-down
Timers	2 x 32-bit and 2 x 24-bit RTC with 12-bit prescaler, watchdog

* Not all simultaneously

Package

Dimensions	9.8 x 14.0 x 1.9 mm
Weight	< 1.0 g
Mounting	Machine mountable Solder pins

Environmental data, quality & reliability

Operating temperature	-40 °C to +85 °C
Storage temperature	-40 °C to +125 °C
Humidity	RH 5 – 90% non-condensing
RoHS	RoHS 3 compliant

Electrical data

Power supply	1.7 VDC to 3.6 VDC
Power consumption in Bluetooth low energy mode	Active TX @ 0 dBm: 4.6 mA Full RAM retention, wake on RTC: 1.5 µA No RAM retention, wake on RTC: 1.3 µA Sleep, full RAM retention: 500 nA Sleep, no RAM retention: 300 nA

Certifications and approvals

Type approvals	Europe (ETSI RED); US (FCC/CFR 47 part 15 unlicensed modular transmitter approval); Canada (ISED RSS); Australia and New Zealand (RCM)
Health and safety	EN 62479, EN 60950-1, IEC 60950-1
Bluetooth qualification	v5.1 (Bluetooth low energy), Bluetooth RF PHY

Support products

BMD-360-Eval	Evaluation kit for BMD-360 with open CPU and internal PCB antenna
--------------	---

Product variants

BMD-360	With PCB antenna, open CPU
---------	----------------------------



R41Z module

Stand-alone Bluetooth 4.2 low energy and 802.15.4 module

Complete Bluetooth Low Energy v4.2 and 802.15.4 (Thread and Zigbee) solution

- Powerful & ultra-efficient 48MHz 32-bit Arm® Cortex®-M0+ CPU with 512kB Flash & 128kB SRAM
- High resolution 16-bit ADC
- Operating temperature -40 °C to 105 °C
- Buck-boost DC-DC converter for operating voltage 0.9-4.2 V
- Certified for Europe, USA, Canada, Japan, Australia / New Zealand

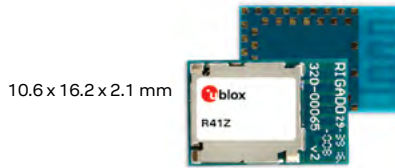

R41Z

	R41Z
Grade	
Automotive	
Professional	
Standard	•
Radio	
Chip inside	NXP KW41Z
Bluetooth qualification	v4.2
Bluetooth low energy	•
Thread / Zigbee	•
Bluetooth output power EIRP [dBm]	3
Max range [meters]	150
NFC	
Antenna type (see footnotes)	pcb
Application software	
Open CPU for embedded applications	•
Interfaces	
UART	◆
SPI	◆
I2C	◆
I2S	
USB	
PWM	◆
TSI	◆
GPIO pins	25
AD converters [number of bits]	16
Features	
MCU (see footnotes)	M0+
RAM [kB]	128
Flash [kB]	512
Simultaneous GATT server and client	◆
Throughput [Mbit/s]	
Maximum Bluetooth connections	2
Secure boot	
Bluetooth mesh	
FOTA	◆

Product description

The R41Z module is an ultra-low-power, highly-integrated single-chip device that enables concurrent Bluetooth low energy and IEEE 802.15.4 (Thread and Zigbee) connectivity for portable, extremely low-power embedded systems. With an Arm® Cortex®-M0+ CPU, integrated 2.4 GHz transceiver, and an integrated antenna, the R41Z provides a complete RF solution allowing faster time to market with reduced development costs.

The R41Z module is based on the NXP KW41Z chip, and the module provides access to all its capabilities and peripherals. With the integrated buck-boost DC-DC converter, the module can be powered from only 0.9 V up to 4.2 V, thus supporting a wide range of batteries including single cell types. The module also includes a high-performance A/D converter at the MCU level, for sensor aggregation and other sophisticated applications. All functions are supported at the extended operating temperature range of -40 °C to +105 °C, making the module suitable also for the most challenging environments.

pcb = Internal PCB antenna ◆ = Feature enabled by HW. The actual support depends on the open CPU application SW.
 M0+ = 48 MHz Arm Cortex-M0+



Features

Bluetooth	v4.2 (Bluetooth low energy)
Range	150 m
Max. radiated output power	3 dBm
Conducted sensitivity	-95 dBm (1 Mbit/s) -100 dBm (125 Kbit/s)
Bluetooth address	Unique public Bluetooth address provided (on label)
Bluetooth operating modes	Simultaneous central and peripheral roles LE 1M PHY (1 Mbps) LE Data Length Extension
Antenna	Integrated PCB antenna
Development environment	MCUXpresso IDE and SDK Customers develop and embed their own application in the R41Z modules (open CPU concept)
Security	Secure Simple Pairing 128-bit AES encryption Bluetooth low energy secure connections

Interfaces and peripherals*

UART	1 block. 1200 baud to 1 M baud, parity, CTS and RTS support
SPI master	2 blocks. 125 kHz to 8 Mhz clock rates
SPI Slave	2 blocks. 125 kHz to 8 Mhz clock rates
I2C master/slave	2 blocks. 100 kHz to 400 kHz clock rates
ADC	4-ch single ended or 1-ch differential, 16-bit
DAC	1-channel, 12-bit
GP Comparator	8-ch, VCC and internal ref, 64 levels
Temp. Sensor	Internal, -40 °C to 105 °C
GPIO	25 - Input High: 0.7 x VCC; Input Low: 0.3 x VCC; pull-up/pull-down
Timers / PWM	2-ch to 8-ch, 16-bit with prescaler, watchdog

* Not all simultaneously

Package

Dimensions	10.6 x 16.2 x 2.1 mm
Weight	< 1.0 g
Mounting	Machine mountable Solder pins

Environmental data, quality & reliability

Operating temperature	-40 °C to +105 °C
Storage temperature	-40 °C to +125 °C
Humidity	RH 5 – 90% non-condensing
RoHS	RoHS 3 compliant

Electrical data

Power supply	1.7 VDC to 3.6 VDC
Power consumption in Bluetooth low energy mode	Active TX @ 0 dBm: 6.1 mA Very low power run, 137 µA Very low leakage stop 3, 1.8 µA Very low leakage stop 0, 182 nA

Certifications and approvals

Type approvals	US (FCC); Canada (ISED); Europe (ETSI RED); Japan (MIC); Australia & New Zealand(RCM)
Health and safety	EN 62479, EN 60950-1, IEC 60950-1
Bluetooth qualification	v4.2 (Bluetooth low energy), Bluetooth RF PHY

Support products

R41 Z-Eval	Evaluation kit for R41Z with open CPU and internal PCB antenna
------------	--

Product variants

R41 Z	With PCB antenna, open CPU
-------	----------------------------



ODIN-W2 series

Stand-alone IoT gateway modules with Wi-Fi and Bluetooth®

The most versatile industrial IoT gateway modules

- Dual-band Wi-Fi and dual-mode Bluetooth
- Wi-Fi station / access point
- u-connect software for accelerated time to market
- High speed RMII interface
- Wi-Fi enterprise security
- Global certification



14.8 × 22.3 × 3.2 mm

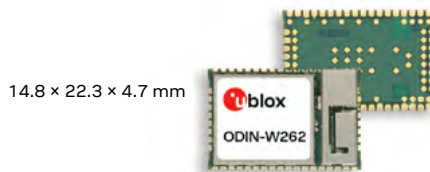

14.8 × 22.3 × 4.7 mm

Product description

The ODIN-W2 is a compact and powerful stand-alone multi-radio module, designed for Internet-of-Things gateway applications. The module includes an embedded Bluetooth stack, Wi-Fi driver, IP stack, and an application for wireless data transfer, all configurable using AT commands. The wireless support includes dual-mode Bluetooth v4.0 (BR/EDR and low energy) and dual-band Wi-Fi (2.4 and 5 GHz bands).

The ODIN-W2 modules are pre-flashed with u-connectXpress software. This software is easy to use and reduces the time, risk and cost of wireless development significantly. The software provides a number of features that can be configured from the host using AT commands.

The module supports point-to-point and point-to-multipoint configurations and can have concurrent Bluetooth and Wi-Fi connections. It can operate in Wireless Multidrop™ or Extended Data Mode for advanced multipoint capabilities. Operation in Point-to-Point Protocol (PPP) mode gives the host a UART-based IP interface for advanced use cases. The software provides support for RMII with a micro Access Point.

The u-connectXpress software for ODIN-W2 enables communication with cloud services. The software features end-to-end security with TLS as well as built-in MQTT protocol for lightweight communication with cloud based applications. ODIN-W2 can also act as a MQTT-SN gateway allowing devices without a TCP/IP stack to make use of the MQTT protocol. This allows for example, networks of Bluetooth low energy sensors to easily communicate with the cloud.

Using the EVK-ODIN-W262 Mbed evaluation kit, the module's integrated Cortex®-M4 with FPU can be accessed for integration of the customer application using Arm Mbed and to save external MCU, crystals, and PCB area in an end product.

Additionally, interfaces like SPI, I2C, CAN, and ADC are made available through the software libraries provided by the Arm Mbed development tool.

The module is professional grade with an extended temperature range and is radio type approved for multiple countries, which reduces the integration work and cost.

ODIN-W260
ODIN-W262
ODIN-W263

	ODIN-W260	ODIN-W262	ODIN-W263
Grade			
Automotive			
Professional	•	•	•
Standard			
Radio			
Chip inside		WL1837	
Bluetooth qualification		v4.0	
Bluetooth low energy	•	•	•
Bluetooth BR/EDR	•	•	•
Bluetooth output power EIRP [dBm]	14	11	11
Antenna type (see footnotes)	U.FL	metal	metal
Wi-Fi 2.4 / 5 [GHz]	2.4 and 5	2.4 and 5	2.4 and 5
Wi-Fi IEEE 802.11 standards	a/b/g/n	a/b/g/n	a/b/g/n
Wi-Fi output power EIRP [dBm]	18	15	15
Max Wi-Fi range [meters]	300	250	250
Application software			
u-connectXpress	•	•	•
Open CPU for embedded apps		•	•
Interfaces			
UART	1	◆	1
SPI		◆	◆
I2C		◆	◆
RMII	1	◆	1
GPIO pins	23	29	23
AD converters (ADC)		12	12
Features			
AT command interface	•	•	•
Point-to-Point Protocol	•	•	•
Low Energy Serial Port Service	•	•	•
MCU (see footnotes)	M4F	M4F	M4F
RAM [kB]	256	256	256
Flash [kB]	2048	2048	2048
Wi-Fi throughput [Mbit/s]	20	20	20
Maximum Bluetooth connections	7	7	7
Micro Access Point [max stations]	10	10	10
Wi-Fi enterprise security	•	•	•
End-to-end security (TLS)	•	•	•
WPA/WPA2	•	•	•
ATEX / IECEx certified	•	•	

U.FL = U.FL connectors for external antenna
metal = Internal metal PIFA antenna
M4F = 168 MHz Arm® Cortex-M4 with FPU

◆ = Feature enabled by HW. The actual support depends on the open CPU application SW.



Features

Wi-Fi standards	IEEE 802.11 a/b/g/n IEEE 802.11 d/e/i/h/r/w
Wi-Fi channels	2.4 GHz: 1-13 5 GHz: 36-165 (U-NII Band 1, 2, 2e, 3)
Wi-Fi maximum transfer rates	IEEE 802.11 a/g: 54 Mbit/s IEEE 802.11 b: 11 Mbit/s IEEE 802.11 n: 130 Mbit/s (MIMO), 65 Mbit/s (SISO)
Bluetooth	v4.0 (Bluetooth low energy and Bluetooth BR/EDR)
Output power	Wi-Fi: 18 dBm EIRP Bluetooth BR/EDR: 14 dBm EIRP Bluetooth LE: 10 dBm EIRP
Sensitivity	Wi-Fi 2.4 GHz: -98 dBm EIRP Wi-Fi 5 GHz: -93 dBm EIRP Bluetooth BR/EDR: -93 dBm EIRP Bluetooth LE: -98 dBm EIRP
Antenna	Internal antenna or dual U.FL connectors for external antennas

u-connectXpress software

Embedded software	u-blox Wi-Fi driver u-blox Bluetooth stack Serial port application Combined IPv4 and limited IPv6 stack Point-to-Point protocol Access point
Wi-Fi Security	WEP 64/128 WPA and WPA2 TKIP and AES/CCMP hardware accelerator LEAP, PEAP, EAP-TLS End-to-end security with TLS
Wi-Fi operational modes	µAP (DFS channels excluded) Station
Bluetooth profiles and services	u-blox Low Energy Serial Port Service GATT SPP DUN PAN roles: PANU and NAP Low energy roles: Central and Peripheral
Max. connections	7
Wireless Multidrop	For concurrent connections to Wi-Fi, Bluetooth BR/EDR and Bluetooth Low Energy
Extended Data Mode™	For individually controlled multipoint data channels
Point-to-Point Protocol (PPP)	For UART-based IP connectivity between host and module, enables individually controlled data channels and AT commands in parallel

Electrical data

Power supply	3.0 VDC - 3.6 VDC
I/O voltage	1.8 V

Package

Dimensions	ODIN-W260: 14.8 x 22.3 x 3.2 mm ODIN-W262: 14.8 x 22.3 x 4.7 mm ODIN-W263: 14.8 x 22.3 x 4.7 mm
Mounting	Solder edge pins with castellations (visually inspectable)

Environmental data, quality & reliability

Operating temperature	-40 °C to +85 °C
-----------------------	------------------

Interfaces

UART	
RMII	
GPIO	
2 U.FL antenna connectors (external antenna version only)	
SPI, I2C, CAN, and ADC are available with Arm Mbed only	

Certifications and approvals

Type approvals ¹	Europe (ETSI RED); US (FCC/CFR 47 part 15 unlicensed modular transmitter approval); Canada (IC RSS); Japan (MIC); Taiwan (NCC); China (SRRC); South Korea (KCC); Australia (ACMA); New Zealand; Brazil (Anatel); South Africa (ICASA); Russia (FSS/FAC)
Health and safety	EN 62479, EN 60950-1, IEC 60950-1
Medical Electrical Equipment	EN 60601-1-2
Bluetooth qualification	v4.0
Explosive atmospheres	ATEX and IECEx*

¹ ODIN-W263 is only approved for use in Europe and other territories where the ETSI Radio Equipment Directive (RED) applies.

Support products

EVK-W262U	Evaluation kit with USB for ODIN-W262
EVK-ODIN-W260 EVK-ODIN-W262	Evaluation kits for ODIN-W2 variants. These Mbed enabled IoT starter kits include USB, Ethernet, and pin list for the ODIN-W2.

Product variants

ODIN-W260	Module with dual U.FL connectors for external antennas, ATEX / IECEx certified*
ODIN-W262	Module with internal antenna, ATEX / IECEx certified*
ODIN-W263	Module with internal antenna, only approved for Europe

* ATEX and IECEx variants available



NINA-W10 series

Stand-alone multiradio modules

The smallest industrial Wi-Fi and Bluetooth modules

- Wi-Fi 802.11b/g/n and dual-mode Bluetooth v4.2
- Powerful open CPU for advanced customer applications
- Small footprint and multiple antenna options
- Pin compatible with other NINA modules
- Global certification

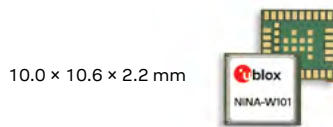

Product description

The NINA-W10 series are stand-alone multiradio MCU modules that integrate a powerful microcontroller (MCU) and a radio for wireless communication. With the open CPU architecture, customers can develop advanced applications running on the dual core 32-bit MCU. The radio provides support for Wi-Fi 802.11b/g/n in the 2.4 GHz ISM band, Bluetooth BR/EDR, and Bluetooth low energy communications.

The NINA-W10 includes the wireless MCU, flash memory, crystal, and components for matching, filtering, antenna and decoupling, making it a very compact stand-alone multiradio module. The module can be used to design solutions with top grade security, thanks to integrated cryptographic hardware accelerators. This enables secure boot, which ensures the module boots up only in the presence of authenticated software. The small size and the embedded security capabilities make NINA-W10 ideal for critical IoT applications where security is important. Intended applications include telematics, low power sensors, connected factories, connected buildings (appliance and surveillance), point-of-sales, and health devices.

Device design is simplified as developers can choose to either use an external antenna (NINA-W101) or take advantage of the internal antenna (NINA-W102). Additionally, the NINA-W10 modules are pin-compatible with other NINA modules, thus offering maximum flexibility for development of similar devices offering different radio technologies.

The NINA-W10 series is globally certified and this reduces time to market for the end product. To ensure operation in harsh professional environments, the modules are industrial grade and qualified according to ISO 16750, supporting an extended temperature range of -40 °C to +85 °C.

NINA-W101

NINA-W102

	NINA-W101	NINA-W102
Grade		
Automotive		
Professional	•	•
Standard		
Radio		
Chip inside	ESP32	
Bluetooth qualification	v4.2	
Bluetooth low energy	•	•
Bluetooth BR/EDR	•	•
Bluetooth output power EIRP [dBm]	9	9
Antenna type (see footnotes)	pin	metal
Wi-Fi 2.4 / 5 [GHz]	2.4	2.4
Wi-Fi IEEE 802.11 standards	b/g/n	b/g/n
Wi-Fi output power EIRP [dBm]	19	19
Max Wi-Fi range [meters]	500	400
Application software		
Open CPU for embedded applications	•	•
Interfaces		
UART	◆	◆
SPI	◆	◆
I2C	◆	◆
I2S	◆	◆
RMII	◆	◆
GPIO pins	20	20
AD converters [number of bits]	12	12
Features		
Point-to-Point Protocol	◆	◆
Low Energy Serial Port Service	◆	◆
MCU (see footnotes)	LX6	LX6
RAM [kB]	520	520
Flash [kB]	2048	2048
Wi-Fi throughput [Mbit/s]	100	100
Maximum Bluetooth connections	8	8
Micro Access Point [max stations]	10	10
Wi-Fi enterprise security	◆	◆
End-to-end security (TLS)	◆	◆
Secure boot	◆	◆
WPA/WPA2	◆	◆

pin = Antenna pin
 metal = Internal metal PIFA antenna
 LX6 = 240 MHz dual-core Xtensa LX6

◆ = Feature enabled by HW. The actual support depends on the open CPU application SW.



Features

Wi-Fi standards	802.11b/g/n
Wi-Fi channels	2.4 GHz channels 1-13
Wi-Fi maximum transfer rates	802.11b: 11 Mbit/s 802.11g: 54 Mbit/s 802.11n: 72 Mbit/s (20 MHz channel bandwidth) 150 Mbit/s (40 MHz channel bandwidth)
Output power	Wi-Fi: 18 dBm EIRP Bluetooth BR/EDR: 8 dBm EIRP Bluetooth low energy: 8 dBm EIRP
Sensitivity (conducted)	Wi-Fi: -96 dBm Bluetooth BR/EDR: -88 dBm Bluetooth low energy: -88 dBm
Bluetooth	v4.2 (Bluetooth BR/EDR and Bluetooth Low Energy)
Antenna	Internal antenna or antenna pin for connecting to the external antenna

Electrical data

Power supply	3.0 V to 3.6 V
Power consumption	Wi-Fi 16 dBm: 190 mA Bluetooth BR/EDR 0 dBm: 130 mA Bluetooth low energy 0 dBm: 130 mA Modem-sleep mode: 30 mA

Interfaces

NINA-W101 and NINA-W102	UART, RMII, I2S, I2C, SPI, ADC, DAC, GPIO, SDIO host, CAN
-------------------------	---

Package

Dimensions	NINA-W101: 10.0 x 10.6 x 2.2 mm NINA-W102: 10.0 x 14.0 x 3.8 mm
Weight	< 1 g
Mounting	Machine mountable Solder pins

Environmental data, quality & reliability

Operating temperature	-40 °C to +85 °C
Storage temperature	-40 °C to +85 °C
Humidity	RH 5-90% non-condensing

Certifications and approvals

Type approvals	Europe (ETSI RED), US (FCC/CFR 47 part 15 unlicensed modular transmitter approval), Canada (IC RSS), Japan (MIC), Taiwan (NCC), South Korea (KCC), Australia (ACMA), New Zealand, Brazil (Anatel), South Africa (ICASA)
Health and safety	EN 62479, EN 60950-1, IEC 60950-1
Medical Electrical Equipment	IEC 60601-1-2
Bluetooth qualification	v4.2

Support products

EVK-NINA-W101	Evaluation kit for NINA-W101 module with antenna pin
EVK-NINA-W102	Evaluation kit for NINA-W102 module with internal antenna

Product variants

NINA-W101	Multiradio wireless MCU module with antenna pin
NINA-W102	Multiradio wireless MCU module with internal antenna



NINA-W15 series

Stand-alone multiradio modules

Secure industrial multiradio made easy

- Simultaneous Wi-Fi 802.11b/g/n and Bluetooth dual-mode
- u-connect software for accelerated time to market
- Built-in security with secure boot
- Small footprint and multiple antenna options
- Pin compatible with other NINA modules
- Global certification

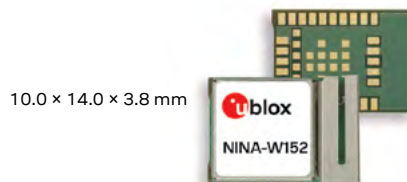
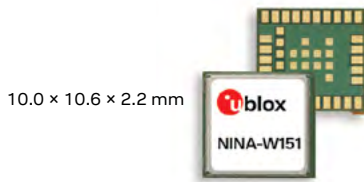

Product description

The NINA-W15 series stand-alone multiradio modules integrate Wi-Fi, Bluetooth BR/EDR and Bluetooth low energy in a compact form factor. The NINA-W15 modules support simultaneous operation on Wi-Fi and Bluetooth dual-mode and can thus serve as a gateway between Bluetooth and Wi-Fi or Ethernet. They can act as both Wi-Fi station and micro access point and connect to a host system using either a UART or a high speed RMII interface. Intended applications include telematics, industrial automation, connected buildings, wireless sensors, point-of-sales, and medical devices.

The modules have many security features embedded, including secure boot, which ensures that only authenticated software is run on the module.

The NINA-W15 modules are used with u-connectXpress software, which is pre-flashed at delivery. This significantly simplifies integration in the host system and speeds up the time to market. The software provides a number of features that can be configured from the host using AT commands.

The u-connectXpress software for NINA-W15 enables communication with cloud services. The software features end-to-end security with TLS and built-in MQTT protocol for lightweight communication with cloud-based applications. NINA-W15 can also act as an MQTT-SN gateway allowing devices without a TCP/IP stack to make use of the MQTT protocol. This allows, for example, networks of Bluetooth low energy sensors to easily communicate with the cloud.

NINA-W15 modules are certified and approved for usage globally. The modules support operation in an extended temperature range of -40 °C to +85 °C.

	NINA-W151	NINA-W152
Grade		
Automotive		
Professional	•	•
Standard		
Radio		
Chip inside	ESP32	
Bluetooth qualification	v4.2	
Bluetooth low energy	•	•
Bluetooth BR/EDR	•	•
Bluetooth output power EIRP [dBm]	8	8
Antenna type (see footnotes)	pin	metal
Wi-Fi 2.4 / 5 [GHz]	2.4	2.4
Wi-Fi IEEE 802.11 standards	b/g/n	b/g/n
Wi-Fi output power EIRP [dBm]	18	18
Max Wi-Fi range [meters]	500	400
Application software		
u-connectXpress	•	•
Interfaces		
UART	1	1
RMII	1	1
GPIO pins	13	13
Features		
AT command interface	•	•
Point-to-Point Protocol	•	•
Low Energy Serial Port Service	•	•
MCU (see footnotes)	LX6	LX6
RAM [kB]	520	520
Flash [kB]	2048	2048
Wi-Fi throughput [Mbit/s]	16	16
Maximum Bluetooth connections	7	7
Micro Access Point [max stations]	10	10
Wi-Fi enterprise security	•	•
End-to-end security (TLS)	•	•
Secure boot	•	•
WPA/WPA2	•	•

pin = Antenna pin
metal = Internal metal PIFA antenna

LX6 = 240 MHz dual-core Xtensa LX6



Features

Wi-Fi standards	802.11b/g/n 802.11d/e/i/h
Wi-Fi channels	2.4 GHz channels 1-13
Wi-Fi maximum transfer rates	802.11b: 11 Mbit/s 802.11g: 54 Mbit/s 802.11n: 72 Mbit/s
Wi-Fi output power	18 dBm EIRP
Wi-Fi Sensitivity (conducted)	-96 dBm conducted
Bluetooth output power	8 dBm EIRP (Bluetooth BR/EDR) 8 dBm EIRP (Bluetooth low energy)
Bluetooth sensitivity	-88 dBm conducted (Bluetooth BR/EDR 1 Mbit/s) -88 dBm conducted (Bluetooth low energy)
Antenna	Internal antenna or antenna pin for connecting to the external antenna

u-connectXpress software

This section describes the NINA-W15 features integrated in the u-connectXpress software. All NINA-W15 modules are delivered with this software and the module is configured using AT commands.

Wi-Fi features	Wi-Fi station Wi-Fi micro access point
Bluetooth features	SPP profile u-blox Low Energy Serial Port Service (SPS) GATT server and client Central and peripheral roles Up to 5 peripheral connections
Security features	WPA/WPA2 Enterprise security (EAP-TLS, PEAP) End-to-end security with TLS Secure boot Secure simple pairing
Extended Data Mode™	For individually controlled multipoint data channels
Point-to-Point Protocol	For UART-based IP connectivity between host and module, enables individually controlled data channels and AT commands in parallel
Configuration over air	Wireless transmission of AT commands to control the module
HW interfaces	UART, RMII, GPIO
Throughput	Bluetooth low energy: 350 kbit/s Bluetooth BR/EDR: 1 Mbit/s Wi-Fi: 16 Mbit/s
Support tools	s-center

Interfaces

NINA-W151 and NINA-W152	UART, RMII, GPIO
-------------------------	------------------

Package

Dimensions	NINA-W151: 10.0 x 10.6 x 2.2 mm NINA-W152: 10.0 x 14.0 x 3.8 mm
Weight	< 1 g
Mounting	Machine mountable Solder pins

Environmental data, quality & reliability

Operating temperature	-40 °C to +85 °C
Storage temperature	-40 °C to +85 °C
Humidity	RH 5-90% non-condensing

Electrical data

Power supply	3.3 V
Power consumption	Wi-Fi 15 dBm: 117 mA Bluetooth BR/EDR: 166 mA Bluetooth low energy: 67 mA Idle mode: 33 mA

Certifications and approvals

Type approvals	Europe (ETSI R&TTE), US (FCC/CFR 47 part 15 unlicensed modular transmitter approval), Canada (IC RSS), Japan (MIC), Taiwan (NCC), South Korea (KCC), Brazil (Anatel), Australia (ACMA), New Zealand; South Africa (ICASA)
Health and safety	EN 62479, EN 60950-1, IEC 60950-1
Medical Electrical Equipment	IEC 60601-1-2
Bluetooth qualification	v4.2 (Bluetooth BR/EDR and Bluetooth low energy)

Support products

EVK-NINA-W151	Evaluation kit for NINA-W151 module with antenna pin and external antenna
EVK-NINA-W152	Evaluation kit for NINA-W152 module with internal antenna

Product variants

NINA-W151	With u-connectXpress software and antenna pin
NINA-W152	With u-connectXpress software and internal antenna



NINA-W13 series

Stand-alone Wi-Fi modules

Secure industrial Wi-Fi modules

- Wi-Fi 802.11b/g/n
- u-connect software for accelerated time to market
- Built-in security with secure boot
- Small footprint and multiple antenna options
- Pin compatible with other NINA modules
- Global certification

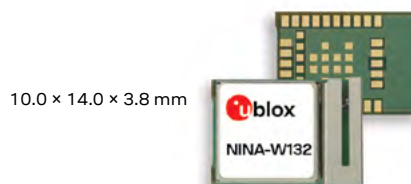
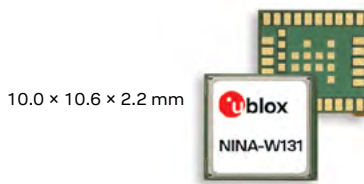

Product description

The NINA-W13 series is a small stand-alone wireless MCU module that integrates a powerful microcontroller (MCU) and a radio for wireless communication. The NINA-W13 modules are pre-flashed with u-connectXpress software. This software is easy to use and reduces the time, risk and cost to add Wi-Fi connectivity to the end product. The host system can set up and control the module through the AT command interface.

The NINA-W13 modules provide top grade security, thanks to secure boot, which ensures the module boots up only with original u-blox software. In addition, they provide end-to-end security on the wireless link and enterprise security to provide a secure connection to the infrastructure. This makes NINA-W13 ideal for critical IoT applications where security is important. The u-connectXpress software for NINA-W13 enables communication with cloud services. The software features end-to-end security with TLS and built-in MQTT protocol for lightweight communication with cloud-based applications. Intended applications include telematics, low power sensors, connected factories, connected buildings (appliances and surveillance), point-of-sales, and health devices.

Device design is simplified as developers can choose to either use an external antenna (NINA-W131) or take advantage of the internal antenna (NINA-W132). Additionally, the NINA-W13 modules are pin-compatible with other NINA modules, thus offering maximum flexibility for development of similar devices offering different radio technologies.

The NINA-W13 series is globally certified and this reduces time to market for the end product. To ensure operation in harsh professional environments, the modules are industrial grade and qualified according to ISO 16750, supporting an extended temperature range of -40 °C to +85 °C.

	NINA-W131	NINA-W132
Grade		
Automotive		
Professional	•	•
Standard		
Radio		
Chip inside	ESP32	
Antenna type (see footnotes)	pin	metal
Wi-Fi 2.4 / 5 [GHz]	2.4	2.4
Wi-Fi IEEE 802.11 standards	b/g/n	b/g/n
Wi-Fi output power EIRP [dBm]	19	19
Max Wi-Fi range [meters]	500	400
Application software		
u-connectXpress	•	•
Interfaces		
UART	1	1
RMII	1	1
GPIO pins	13	13
Features		
AT command interface	•	•
Point-to-Point Protocol	•	•
MCU (see footnotes)	LX6	LX6
RAM [kB]	520	520
Flash [kB]	2048	2048
Wi-Fi throughput [Mbit/s]	16	16
Micro Access Point [max stations]	10	10
Wi-Fi enterprise security	•	•
End-to-end security (TLS)	•	•
Secure boot	•	•
WPA/WPA2	•	•

pin = Antenna pin
metal = Internal metal PIFA antenna

LX6 = 240 MHz dual-core Xtensa LX6



Features

Wi-Fi standards	802.11b/g/n 802.11d/e/i/h
Wi-Fi channels	2.4 GHz channels 1-13
Wi-Fi maximum transfer rates	802.11b: 11 Mbit/s 802.11g: 54 Mbit/s 802.11n: 72 Mbit/s
Output power	Wi-Fi: 18 dBm EIRP
Sensitivity (conducted)	Wi-Fi: -96 dBm
Antenna	Internal antenna or antenna pin for connecting to the external antenna

u-connectXpress software

Connectivity software features	Wi-Fi station Wi-Fi micro access point
Security features	WPA/WPA2 Enterprise security (EAP-TLS, PEAP) Secure boot End-to-end security with TLS
Extended Data Mode™	For individually controlled multipoint data channels
Point-to-Point Protocol	For UART-based IP connectivity between the host and the module; enables individually controlled data channels and AT commands in parallel

Interfaces

NINA-W131 and NINA-W132	UART, GPIO, RMII
-------------------------	------------------

Package

Dimensions	NINA-W131: 10.0 x 10.6 x 2.2 mm NINA-W132: 10.0 x 14.0 x 3.8 mm
Weight	< 1 g
Mounting	Machine mountable Solder pins

Environmental data, quality & reliability

Operating temperature	-40 °C to +85 °C
Storage temperature	-40 °C to +85 °C
Humidity	RH 5-90% non-condensing

Electrical data

Power supply	3.0 V to 3.6 V
Power consumption	Wi-Fi 15 dBm: 125 mA Idle mode: 38 mA

Certifications and approvals

Type approvals	Europe (ETSI RED), US (FCC/CFR 47 part 15 unlicensed modular transmitter approval), Canada (IC RSS), Japan (MIC), Taiwan (NCC), South Korea (KCC), Brazil (Anatel), Australia (ACMA), New Zealand, South Africa (ICASA)
Health and safety	EN 62479, EN 60950-1, IEC 60950-1
Medical Electrical Equipment	EN 60601-1-2

Support products

EVK-NINA-W131	Evaluation kit for NINA-W131 module with antenna pin
EVK-NINA-W132	Evaluation kit for NINA-W132 module with internal antenna

Product variants

NINA-W131	Wi-Fi module with antenna pin
NINA-W132	Wi-Fi module with internal antenna

JODY-W2 series

Host-based multiradio modules with Wi-Fi and Bluetooth

Smallest, most flexible automotive modules supporting Wi-Fi 802.11ac at 105 °C

- Dual band Wi-Fi 2.4 GHz and 5 GHz 802.11a/b/g/n/ac
- Dual-mode Bluetooth 5 (Bluetooth BDR/EDR/Low Energy)
- Supports operation at 105 °C
- Simultaneous access point (AP), station (STA), or Wi-Fi Direct (P2P)
- Optimized for parallel operation of Wi-Fi and Bluetooth



13.8 × 19.8 × 2.5 mm

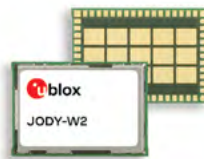

Product description

JODY-W2 is a compact module based on Marvell 88W8987 AEC-Q100 compliant chipsets. It enables Wi-Fi, Bluetooth EDR, and Bluetooth low energy communications, and is thus ideal for in-vehicle infotainment and telematics, industrial applications such as machine control, and other applications requiring high data rates. The module is built to meet the requirements for operation in very high temperatures, such as telematics systems in cars. JODY-W2 supports 1x1 single-antenna 802.11ac Wi-Fi operation, with data rates up to 433 Mbit/s. A second antenna is dedicated for Bluetooth operation.

JODY-W2 is a host-based module that requires a host processor running a Linux or Android operating system. It connects to a host processor through SDIO (for Wi-Fi), or High-Speed UART (for Bluetooth) interfaces. Support for other operating systems such as QNX will also be available.

JODY-W2 undergoes extended automotive qualification according to ISO 16750-4 and is manufactured in line with ISO/TS 16949. Radio type approvals are pending for the US, Europe, and Canada.

Key features

- Wi-Fi 1x1 SISO IEEE 802.11ac data rates up to 433 Mbit/s (PHY), beamforming
- Supports 802.11d/e/h/i/k/r/u/v/w/ai
- Wi-Fi 20, 40, and 80 MHz channels
- Bluetooth and Bluetooth low energy v5.0; Bluetooth low energy 5.0 supporting 2 Mbit/s
- Extended temperature range -40 °C to +105 °C
- Chipset is compliant with AEC-Q100
- SDIO host interface
- PCM interface for Bluetooth audio
- Access point mode for up to 8 stations
- Hardware encryption engines: AES and TKIP
- Security: WPA, WAPI, WPA2, WPA3, WPS and Easy Connect

	JODY-W263-A	JODY-W263
Grade		
Automotive	•	
Professional		•
Standard		
Radio		
Bluetooth qualification	v5.0	v5.0
Bluetooth profiles	HCI	HCI
Bluetooth BR/EDR	•	•
Bluetooth low energy	•	•
Wi-Fi IEEE 802.11 standards	a/b/g/n/ac	a/b/g/n/ac
Wi-Fi 2.4 / 5 [GHz]	2.4 and 5	2.4 and 5
LTE filter		
Max output power at antenna pin [dBm]	18	18
Antenna type	2p	2p
OS support		
Android / Linux (from u-blox)	•	•
Interfaces		
SDIO [version] (for Wi-Fi only)	v3	v3
UART (for Bluetooth only)	1	1
PCM (Bluetooth audio)	1	1
Features		
Micro Access Point [max connects]	8	8
AES hardware support	•	•
RF parameters in OTP memory	•	•
MAC addresses in OTP memory	•	•

2p = Two pins for Wi-Fi and Bluetooth antennas



Features

Wi-Fi standards	IEEE 802.11a/b/g/n/ac IEEE 802.11d/e/h/i/k/r/u/v/w/ai
Wi-Fi channels	2.4 GHz: 1-13 5 GHz: 36-165
Bluetooth	v5.0 (Bluetooth low energy and Bluetooth with EDR) Class 1 and 2 transmission
Antenna	Antenna pin 1: 2.4 GHz and 5 GHz Wi-Fi Antenna pin 2: 2.4 GHz Bluetooth
Output power	Wi-Fi IEEE 802.11b: 18 dBm Wi-Fi IEEE 802.11a/g/n/ac: 16.5 dBm Bluetooth BDR: 13 dBm (w/o LTE filter) Bluetooth EDR: 10 dBm (w/o LTE filter)
Security	Hardware encryption engine: AES-CCMP, AES-GCMP, TKIP WPA/WPA2/WPA3 128-bit AES hardware support

Software features

RF parameters	Available in on-board OTP memory
MAC addresses	Available in on-board OTP memory
Security	WEP WPA2 (CCMP, AES), WAPI WPA3 (OWE, SAE, CSNA, DPP)
Wi-Fi modes	Station (STA): Infrastructure & Direct mode AP: Supports up to 8 stations Wi-Fi direct
Driver support	Linux drivers in source code

Interfaces

Wi-Fi	SDIO v3.0 (4-bit, 208 MHz)
Bluetooth	High-speed UART, 4-wire, up to 4 Mbit/s PCM audio, 8, 16 KHz sampling
Other interfaces	GPIOs

Package

Dimensions	13.8 × 19.8 × 2.5 mm
Mounting	Solder pins (LGA), 60 pins, additional large ground pins

Environmental data, quality & reliability

Operating temperature	-40 °C to +85 °C -40 °C to +105 °C
Automotive qualification according to ISO 16750-4	

Electrical data

Power supply	2.8 V – 5.5 VDC
VIO power supply	1.8 VDC
I/O power supply	3.3 VDC or 1.8 VDC

Certifications and approvals¹

Europe (ETSI RED)
USA (FCC CFR part 15) ²
Canada (ISED) ²

1 = Pending approval
2 = DFS master and DFS slave support

Support products

EVK-JODY-W263	Evaluation kit for JODY-W263
---------------	------------------------------

Product variants

JODY-W263-00A	Automotive grade with 2 antenna pins, 85 °C
JODY-W263-00B	Professional grade with 2 antenna pins, 85 °C
JODY-W263-01A	Automotive grade with 2 antenna pins, 105 °C



JODY-W1 series

Host-based multiradio modules with Wi-Fi and Bluetooth

Smallest, most flexible automotive modules supporting Wi-Fi Real Simultaneous Dual Band (RSDB)

- Dual band Wi-Fi with 2x2 MIMO 802.11a/b/g/n/ac
- Real Simultaneous Dual Band (RSDB) Wi-Fi 2.4 GHz and 5 GHz
- Dual-mode Bluetooth® (Bluetooth/Bluetooth Low Energy) v4.2
- Simultaneous operation modes: access point (AP), station (STA), Wi-Fi Direct (P2P)
- Optimized for parallel operation of Wi-Fi and Bluetooth



13.8 × 19.8 × 2.5 mm

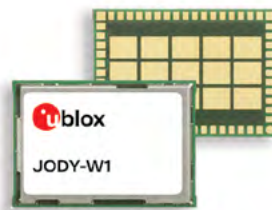

Product description

JODY-W1 compact modules are based on Cypress CYW88359 and CYW89359 AEC-Q100 compliant chipsets. They provide Wi-Fi and Bluetooth EDR/low energy communication, and are thus ideal for in-vehicle infotainment and telematics applications that require high data rates. Use cases include in-car hotspots, Wi-Fi display applications like Apple CarPlay, or video streaming across multiple clients. JODY-W1 can be operated in the following modes:

- Wi-Fi 2x2 MIMO 802.11ac in 2.4 GHz or 5 GHz
- Wi-Fi 1x1 802.11ac in 2.4/5 GHz real simultaneous dual band
- Dual-mode Bluetooth v4.2, including audio, can be operated fully simultaneous with both the Wi-Fi modes

JODY-W1 modules undergo extended automotive qualification according to ISO 16750-4 and are manufactured in line with ISO/TS 16949. They connect to a host processor through PCIe, SDIO, or High-Speed UART interfaces. Radio type approvals are pending for many countries, and more certifications are planned.

Key features

- Real simultaneous dual band - parallel operation of 2.4 GHz (802.11n) and 5 GHz (802.11ac) Wi-Fi
- 2x2 MIMO IEEE 802.11ac data rates up to 867 Mbit/s (PHY), beamforming
- TurboQAM high speed 802.11n for faster 2.4 GHz access point application
- Chipset is compliant with AEC-Q100
- Wi-Fi 20, 40, and 80 MHz channels
- Bluetooth and Bluetooth Low Energy v4.2
- PCIe high speed interface
- PCM and I2S interfaces for Bluetooth audio
- Access point mode for up to 10 stations
- Hardware encryption engines: AES and TKIP
- Security: WPA, WAPI, WPA2, and WPS
- Extended temperature range -40 °C to +85 °C
- Smallest possible form factor

	JODY-W163	JODY-W164	JODY-W167
Grade			
Automotive	•	•	•
Professional			
Standard			
Radio			
Bluetooth qualification		v4.2	
Bluetooth profiles		HCI	
Bluetooth BR/EDR	•	•	•
Bluetooth low energy	•	•	•
Wi-Fi IEEE 802.11 standards		a/b/g/n/ac	
Wi-Fi 2.4 / 5 [GHz]		2.4 and 5	
LTE filter	o	o	o
Bluetooth output power conducted [dBm]	10	10	10
Wi-Fi output power conducted [dBm]	18	18	18
Antenna type	2p	2p	3p
OS support			
Android / Linux drivers (from u-blox)	•	•	•
QNX (via third party)	•	•	•
Interfaces			
High-speed UART ^B	1	1	1
PCIe ^W		1	1
SDIO ^W [version]		v3	
PCM (Bluetooth audio)	1	1	1
Features			
Micro Access Point [max connects]	10	10	10
AES hardware support	•	•	•
Wi-Fi direct	•	•	•
Factory-assigned MAC address	•	•	•
Factory calibrated RF	•	•	•
Simultaneous STA/AP on different channels	•	•	•

B = For Bluetooth only
W = For Wi-Fi only
o = On request
2p = 2 antenna pins, one each for Bluetooth and Wi-Fi
3p = 3 pins, 2 for Wi-Fi and 1 for Bluetooth antenna



Features

Wi-Fi standards	IEEE 802.11a/b/g/n/ac 2x2 MIMO for 11ac IEEE 802.11d/e/h/i/w
Wi-Fi channels	2.4 GHz: 1-13 5 GHz: 36-165
Bluetooth	v4.2 (Bluetooth low energy and Bluetooth with EDR) Class 1 and 2 transmission
Antenna	JODY-W163 and JODY-W164: – Pin 1: 2.4 GHz and 5 GHz Wi-Fi - RSDB mode – Pin 2: 2.4 GHz Bluetooth JODY-W167: – Pin 1: 2.4 GHz and 5 GHz Wi-Fi - 2x2 MIMO – Pin 2: 2.4 GHz and 5 GHz Wi-Fi - 2x2 MIMO – Pin 3: 2.4 GHz Bluetooth
Output power	Wi-Fi IEEE 802.11b: 18 dBm Wi-Fi IEEE 802.11a/g/n/ac: 16.5 dBm Bluetooth BR: 10 dBm Bluetooth EDR: 8 dBm
Security	Hardware encryption engine: AES-CCMP, TKIP WPA/WPA2, WAPI, WEP

Software features

RF parameters	Available in on-board OTP memory
MAC addresses	Available in on-board OTP memory
Security	WEP WPA2 (CCMP, AES), WAPI 128-bit AES hardware support
Wi-Fi modes	Station (STA): Infrastructure & Direct mode AP: Supports up to 10 stations Wi-Fi direct One single firmware for Wi-Fi STA, AP and Bluetooth
Driver support	Free of charge drivers for Linux and Android Third party drivers for QNX

Interfaces

Wi-Fi	PCIe v3.0 SDIO v3.0 (4-bit, 208 MHz)
Bluetooth	High-speed UART, 4-wire, up to 4 Mbit/s PCM audio, 8, 16 KHz sampling I2S for Bluetooth audio
Other interfaces	GPIOs

Package

Dimensions	13.8 × 19.8 × 2.5 mm
Mounting	Solder pins (LGA), 60 pins, additional large ground pins

Environmental data, quality & reliability

Operating temperature	-40 °C to +85 °C
Automotive qualification	according to ISO 16750-4

Electrical data

RF power supply	3.2 V – 4.8 VDC
I/O power supply	3.3 VDC or 1.8 VDC

Certifications and approvals

Type approvals	Europe (ETSI RED); US (FCC CFR part 15); Canada (ISED)
Bluetooth qualification	v4.2 (Bluetooth BR/EDR and Bluetooth low energy)

Support products

EVK-JODY-W163	Evaluation kit for JODY-W163
EVK-JODY-W164	Evaluation kit for JODY-W164

Product variants

JODY-W163	Automotive grade with 2 antenna pins, RSDB mode with a single antenna pin, SDIO interface
JODY-W164	Automotive grade with 2 antenna pins, RSDB mode with a single antenna pin, PCIe interface
JODY-W167	Automotive grade with 3 antenna pins, 2x2 MIMO mode, PCIe interface



EMMY-W1 series

Host-based multiradio modules with Wi-Fi and Bluetooth

The most robust and comprehensive modules with Wi-Fi and Bluetooth® coexistence

- Automotive and professional grades
- Dual-band Wi-Fi with IEEE 802.11ac
- Dual-mode Bluetooth v4.2 with BR/EDR and Bluetooth low energy
- Simultaneous client and micro access point operation for up to 10 clients
- Integrated LTE filter



13.8 × 19.8 × 2.5 mm

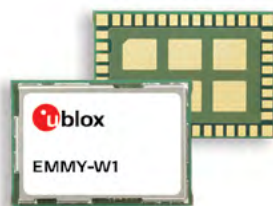

Product description

EMMY-W1 is an ultra-compact multiradio module providing Wi-Fi 802.11ac, Bluetooth BR/EDR, and Bluetooth low energy with an extended temperature range from -40 °C to +85 °C offered in automotive and professional grades. It is designed for both simultaneous and independent operations of:

- Wi-Fi IEEE 802.11ac and a/b/g/n
- Dual-mode Bluetooth v4.2

EMMY-W1 is an SMD component that can easily be integrated into the application. Together with a host and the free-of-charge driver, it provides a complete wireless modem solution. The module is connected to the host processor through SDIO and High-Speed UART interfaces. EMMY-W1 is radio type approved for Europe, US, Canada, Japan, South Korea, Taiwan, China, and Australia/New Zealand.

Key features

- Wi-Fi Standards IEEE 802.11a/b/g/n/ac
- Support of Wi-Fi direct mode
- IEEE 802.11 PHY data rates of up to 433 Mbps
- Suitable for HD video streaming
- Concurrent multiradio connections
- Wireless Apple CarPlay, Android Auto, Baidu CarLife support
- Hardware encryption engine for 128-bit AES
- WAPI support
- Bluetooth v4.2 with Bluetooth low energy & Bluetooth BR/EDR
- PCM interface for audio
- Climatic, mechanical, and operating life qualification tests according to ISO 16750-4
- AEC-Q100 compliant radio chipset

	EMMY-W161	EMMY-W163	EMMY-W165
Grade			
Automotive	•	•	•
Professional	•	•	•
Standard			
Radio			
Bluetooth qualification		v4.2	
Bluetooth profiles		HCI	
Bluetooth BR/EDR	•	•	•
Bluetooth low energy	•	•	•
Wi-Fi IEEE 802.11 standards		a/b/g/n/ac	
Wi-Fi 2.4 / 5 [GHz]		2.4 and 5	
LTE filter	•		
Bluetooth output power conducted [dBm]	10	10	10
Wi-Fi output power conducted [dBm]	18	18	18
Antenna type	1p	2p	1p
OS support			
Android / Linux drivers (from u-blox)	•	•	•
QNX (via third party)	•	•	•
Interfaces			
High-speed UART [®]	1	1	1
SDIO [version]	v3	v3	v3
PCM (Bluetooth audio)	1	1	1
Features			
Micro Access Point [max connects]	10	10	10
AES hardware support	•	•	•
Wi-Fi direct	•	•	•
Factory-assigned MAC address	•	•	•
Factory calibrated RF	•	•	•
Simultaneous STA/AP on different channels	•	•	•

1p = 1 antenna pin for combined Bluetooth and Wi-Fi
 2p = For Bluetooth only 2p = 2 antenna pins, one each for Bluetooth and Wi-Fi



Features

Wi-Fi standards	IEEE 802.11 a/b/g/n/ac IEEE 802.11 d/e/h/i/k*/r /v*/w
Wi-Fi transfer rates	IEEE 802.11 n/ac: – max. 433 Mbps (80 MHz channel) – max. 200 Mbps (40 MHz channel) – max. 86 Mbps (20 MHz channel) IEEE 802.11 g: 54,48,36,24,18,12,9,6 Mbps IEEE 802.11 b: 11, 5.5, 2, 1 Mbps
Wi-Fi channels	2.4 GHz: 1-13 5 GHz: 36-165 (U-NII band 1, 2, 2e, 3)
Bluetooth	v4.2 (Bluetooth low energy and Bluetooth BR/EDR)
Antennas	EMMY-W161 & EMMY-W165: – 1 combined antenna pin for Bluetooth and Wi-Fi antennas EMMY-W163: – 2 separate antenna pins for Bluetooth and Wi-Fi antennas
LTE filter	Integrated BAW filter (EMMY-W161 only)
Output power	Wi-Fi IEEE 802.11 b: 18 dBm Wi-Fi IEEE 802.11 a/g/n/ac: 16 dBm Bluetooth BR: 10 dBm Bluetooth EDR: 8 dBm

* Not currently supported by firmware

Software features

RF parameters	Available in on-board OTP memory
MAC addresses	Available in on-board OTP memory
Security	WEP64 / 128 WPA (TKIP, AES) WPA2 (CCMP, AES) WAPI 128-bit AES hardware support
Wi-Fi operational modes	Station (STA): Infrastructure & Direct mode μAP: Supports up to 10 stations Simultaneous STA and μAP Simultaneous dual-band (2.4/5 GHz) Wi-Fi direct One single firmware for Wi-Fi STA, μAP and Bluetooth
Driver support	Free of charge drivers for Linux and Android Third party drivers for QNX
Wi-Fi/Bluetooth coexistence	Internal TDM mechanism

Interfaces

Wi-Fi	SDIO 3.0 (4-bit, up to 150 MHz clock)
Bluetooth	SDIO 3.0 (4-bit), High-speed UART
Bluetooth audio	PCM

Package

Dimensions	13.8 × 19.8 × 2.5 mm
Mounting	Solder pins (LGA)

Environmental data, quality & reliability

Operating temperature	-40 °C to +85 °C
Automotive qualification according to ISO 16750-4	
AEC-Q100 compliant radio chipset	

Electrical data

RF power supply	3.0 – 3.6 VDC
I/O power supply	3.3 VDC or 1.8 VDC

Certifications and approvals

Type approvals	Europe (ETSI RED); US (FCC/CFR 47 part 15 unlicensed modular transmitter approval); Canada (IC RSS); Japan (MIC)*; South Korea (KCC)*; Taiwan (NCC)*; Australia/New Zealand (ACMA)*; China (SRRC)*
Bluetooth qualification	v4.2 (Bluetooth BR/EDR and Bluetooth low energy)

* See the Data Sheet for details

Support products

The EMMY-W1 evaluation kits include an evaluation board with full access to the module interfaces. The board includes antennas for Wi-Fi and Bluetooth. It also includes U.FL connectors for connecting external Wi-Fi and Bluetooth antennas. The kit has a standard SDIO connector for host communication.

EVK-EMMY-W161	Evaluation kit for EMMY-W161, EMMY-W161-A, EMMY-W165 and EMMY-W165-A
EVK-EMMY-W163	Evaluation kit for EMMY-W163 and EMMY-W163-A

Product variants

EMMY-W161	Professional grade module with 1 combined antenna pin for Wi-Fi and Bluetooth; integrated LTE filter
EMMY-W163	Professional grade module with 2 separate antenna pins for Wi-Fi and Bluetooth (no LTE filter)
EMMY-W165	Professional grade module with 1 combined antenna pin for Wi-Fi and Bluetooth (no LTE filter)
EMMY-W161-A	Automotive grade module with 1 combined antenna pin for Wi-Fi and Bluetooth; integrated LTE filter
EMMY-W163-A	Automotive grade module with 2 separate antenna pins for Wi-Fi and Bluetooth (no LTE filter)
EMMY-W165-A	Automotive grade module with 1 combined antenna pin for Wi-Fi and Bluetooth (no LTE filter)



LILY-W1 series

Ultra-compact host-based Wi-Fi modules

The most economical, lean, and compact Wi-Fi modules

- Extremely small footprint
- On-board antenna
- Integrated LTE filter
- Micro access point feature for up to 8 clients
- Wi-Fi direct

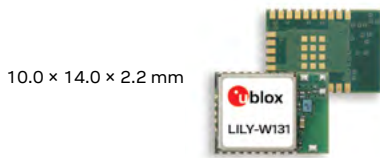

Product description

The LILY-W1 series ultra-compact Wi-Fi front end modules include an integrated MAC/baseband processor and RF front end components. The modules connect to a host via SDIO or USB interface. They provide simultaneous operation as a station and a micro access point for up to 8 clients. The LILY-W132 variant further includes an internal antenna and LTE filter to enable in-device co-existence without jeopardizing Wi-Fi performance. LILY-W1 is certified for US, Europe, Canada, Taiwan, and Japan. Approvals for other countries are possible upon inquiry.

Key features

- Wi-Fi Standards IEEE 802.11b/g/n
- 802.11n 1x1 SISO
- 802.11 PHY data rates of up to 72 Mbps
- Station and micro access point operation with up to 8 clients
- AES-CCMP and WAPI hardware encryption
- Dual MAC addresses and RF parameters stored on the module
- 1.8 V or 3.3 V IO signal levels
- Extended operating temperature range of -40 °C to +85 °C

	LILY-W131	LILY-W132
Grade		
Automotive		
Professional	•	•
Standard		
Radio		
Wi-Fi IEEE 802.11 standards	b/g/n	b/g/n
Wi-Fi 2.4 / 5 [GHz]	2.4	2.4
LTE filter		•
Channel width [MHz]	20	20
Antenna type	1a	i
OS support		
Android / Linux (from u-blox)	•	•
Interfaces		
SDIO [version]	v2	v2
USB 2.0	1	1
Features		
Micro Access Point [max connects]	8	8
AES hardware support	•	•
Wi-Fi direct	•	•
Factory-assigned MAC address	•	•
Factory calibrated RF	•	•

i = Internal antenna 1a = 1 pin for external antenna



Features

Wi-Fi IEEE 802.11	b/g/n (single-stream, 72 Mbps)
Channels	2.4 GHz channels 1-13
Channel bandwidth	20 MHz
Range (max)	200 m
Output power (max)	LILY-W131: 19 dBm including 3 dBi antenna gain LILY-W132: 15 dBm including antenna gain
LTE filter	Embedded LTE frequency filter (LILY-W132 only)

Software features

RF parameters	Available in on-board OTP memory
MAC addresses	Available in on-board OTP memory
Security	WPA-PSK WPA2-PSK TKIP and AES hardware accelerator WAPI
Operational modes	Station (STA) / Client Micro-AP supports up to 8 stations Simultaneous STA and Micro-AP
Driver support	Free of charge drivers for: – Android – Linux

Interfaces

Host interface	SDIO 2.0 USB 2.0 (slave/device)
I/O signals	1.8 V or 3.3 V selectable

Package

Dimensions	10.0 x 14.0 x 2.2 mm (LILY-W131) 10.0 x 14.0 x 3.8 mm (LILY-W132)
Weight	< 2 g
Mounting	Solder edge pins with castellations (visually inspectable)

Environmental data, quality & reliability

Operating temperature	–40 °C to +85 °C
Cold	EN 60068-2-1
Dry heat	EN 60068-2-2
Change of temperature	EN 60068-2-14 and EN 60068-2-27
Vibration	EN 60068-2-6
Road vehicles	ISO 16750
Production & design	IPC-a-610 class 3

Electrical data

RF power supply	3.0 VDC – 3.6 VDC
Power consumption	Idle (sleep) mode: < 0.1 mA @ 3.3 VDC Max (Rx/Tx) mode: < 340 mA @ 3.3 VDC

Certifications and approvals

Type approvals	European Radio Equipment Directive (RED), US (FCC/CFR 47 part 15 unlicensed modular transmitter approval), Canada (IC RSS), Japan (Giteki), Taiwan (NCC)
----------------	--

Support products

EVK-LILY-W131	Evaluation kit for LILY-W131. Includes a LILY-W131 module mounted on the adapter board with SDIO card and USB interface, external RPSMA antenna, and RPSMA to U.FL adapter cable.
EVK-LILY-W132	Evaluation kit for LILY-W132. Includes a LILY-W132 module mounted on the adapter board with SDIO card and USB interface.

Product variants

LILY-W131	LILY-W1 module with antenna pin
LILY-W132	LILY-W1 module with internal antenna and LTE filter



VERA-P1 series

DSRC 802.11p V2X host-based modules

The most flexible and best performing V2X modules in the market

- Automotive grade 802.11p V2X transceiver modules for infrastructure and vehicles
- Compliance with WAVE and ETSI ITS G5 for US and Europe operation
- Product variants: Non-concurrent dual-channel with antenna diversity or concurrent dual-channel without antenna diversity
- Communication range of more than 1 km (with line-of-sight)
- Operational in ambient temperature -40 °C to +95 °C



24.8 × 29.6 × 3.5 mm

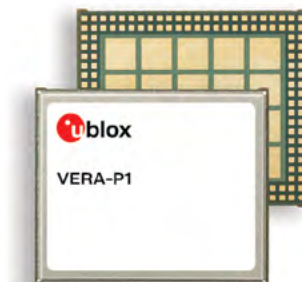

Product description

The VERA-P1 series are compact, embedded transceiver modules that enable development of electronics for Vehicle-to-Everything (V2X) communication systems. These automotive grade modules are designed for applications such as traffic safety and intelligent traffic management. The modules can be used for both in-vehicle units (OBU – On Board Unit) and infrastructure (RSU – Road Side Unit). They provide superior performance compared to V2X systems based on consumer-grade Wi-Fi chipsets, especially at high vehicle speeds and in non-line-of-sight (NLOS) conditions.

The VERA-P1 series includes an integrated MAC/LLC/Baseband processor and the required RF front-end components. The module is connected to a host processor through a USB interface.

Key features

- VERA-P1 is based on the RF chip that scored best RF performance in ETSI plug tests
- The pin-to-pin compatible product variants offer operation modes with single channel or concurrent dual-channel
- The transmit mask meets IEEE 802.11p Class C (5.9 GHz band) requirements
- Security acceleration is integrated in the module

	VERA-P173	VERA-P174
Grade		
Automotive	•	•
Professional		
Standard		
Radio		
Wi-Fi IEEE 802.11 standards	p	p
Channel width [MHz]	10	10
Antenna type	2a	2a
OS support		
Linux	•	•
Interfaces		
USB 2.0	1	1
GPIO	1	1
PPS	1	1
Features		
Antenna diversity	•	#
Single channel operation	•	•
Concurrent dual-channel operation		#

2a = 2 pins for 2 external antennas

= User can configure as dual-channel or diversity



Features

Standards conformance	IEEE 802.11p (IEEE 802.11-2016) ETSI ES 302 663 IEEE 1609.4 - 2016
Frequency band	5.9 GHz
Antenna	2 antenna pins for external 5 GHz antennas
Output power	0 to +23 dBm
Receiver sensitivity	-98 dBm @ 3 Mbit/s
Data rates	3 to 27 Mbit/s

Software features

Operating modes	Non-concurrent dual-channel with antenna diversity Concurrent dual-channel without antenna diversity
Radio channel measurements	Channel utilization Channel active ratio Per-channel statistics Received signal and noise power levels

Interfaces

Host interface	USB 2.0
Other interfaces	GPIO and 1PPS

Package

Dimensions	24.8 x 29.6 x 3.5 mm
Pin-out	160 pins LCC (Leadless Chip Carrier)

Environmental data, quality & reliability

Operating temperature	-40 °C to +95 °C
According to Baseband/radio AEC-Q100 and ISO 16750-4	

Electrical data

Power supply	3.3 V and 5 V
Power consumption	4 W (max)

Certifications and approvals

Europe (ETSI RED)	
US (FCC parts 90, 95L)	

Support products

The VERA-P1 evaluation kit includes an evaluation board with full access to the module interfaces. The board has SMA connectors for connecting external antennas and two antennas.

EVK-VERA-P174	Evaluation kit for VERA-P1 modules
---------------	------------------------------------

Product variants

VERA-P173	Module with single channel and diversity
VERA-P174	Module with single channel and diversity, or dual-channel



UBX-P3

DSRC/802.11p V2X and Wi-Fi chip

Smallest concurrent dual-channel V2X chip

- Compact 9 x 11 x 1.04 mm V2X chip
- Co-packed power management unit
- Concurrent dual channel / diversity for robustness and full coverage around the vehicle
- Operating temperature of -40 °C to +105 °C
- Low power consumption – less than 1 W
- Supports smart antenna deployment

9.0 × 11.0 × 1.04 mm



Product description

The UBX-P3 is a compact Wi-Fi chip that provides full 802.11p functionality for V2X applications. The chip operates on both 5.9 GHz and 760 MHz frequency bands. The UBX-P3 is fully compliant with IEEE WAVE, ETSI V2X, and ARIB T-109M requirements and enables concurrent reception on two 802.11p channels. The chip supports diversity in both transmit and receive directions, thus providing vehicles full coverage with no “dead” areas.

The UBX-P3 chip features an Ethernet host interface, which allows maximal flexibility in placing the chip in a vehicle, independent of the distance from the host processor. It also offers a solution for smart antennas and distributed systems in the vehicle.

The UBX-P3 chip has superior RF performance and a robust design, making it ideal for operation in harsh environments. The chip is fully qualified in accordance with the highly demanding AEC-Q100 grade 2 specification.

Key features

- Supports V2X standards including:
 - IEEE 802.11-2012, IEEE/WAVE (for US)
 - ETSI ITS G5 standards EN 302 663 (for EU)
 - ARIB STD-T109 (Japan)
- Frequency bands: 760 MHz, 5 GHz, and 5.9 GHz
- Channel width: 10/20 MHz (for V2X), 20 MHz (for 802.11a)
- Tx-mask IEEE 802.11p Class C (5 GHz band)
- Operation modes:
 - 802.11p single channel with diversity
 - 802.11p dual channel without diversity
 - 802.11a (5 GHz band only) station mode
- Data rates up to 27 Mbps (10 MHz channel) and 54 Mbps (20 MHz channel)
- ECDSA verification supporting NIST/Brainpool curves, with a minimum throughput of 1000 verifications/sec
- Secure boot from a host CPU or an external flash memory
- Power management unit in the package
- PPS interface for communication with GNSS receivers

UBX-P3

Grade	
Automotive	•
Professional	
Standard	
Radio	
Wi-Fi IEEE 802.11 standards	p/a
Channel width [MHz]	10/20
Rx/Tx diversity	•
Antenna type	3a
OS support	
Android / Linux (from u-blox)	Linux
QNX (via third party)	o
Interfaces	
High-speed UART	4
Ethernet (RGMII/MII/Reverse MII)	1
I ² C	1
Quad SPI and Octal SPI	1
SDIO [version]	v3
GPIO	20
PPS	1
SPI	1
Features	
Antenna diversity	•
Single channel operation	•
Concurrent dual-channel operation	•
Security Acceleration Engine	•

3a = 2 pins for 11p/11a,
1 pin for 760 MHz ITS JPN, if included

o = On request



Features

Wi-Fi standards	IEEE 802.11 a/p
Frequency bands	5 GHz (Channels 36-165) 5.9 GHz (Channels 172-184) 760 MHz
Antenna	2 antenna pins (5 GHz band)
Transmitter	Single channel and diversity (Cyclic Shift Diversity) Supports configurable Root-Raised Cosine windowing for pulse shaping Tx Output power: -3 dBm
Receiver	Single channel and diversity Sensitivity (indicative): -98 dBm (MCS0 - 1 Rx Antenna) -100.2 dBm (MCS0 - 2 Rx Antennas)
Clock	TCXO 26/49.58/52 MHz
Embedded power management chip	
Security	Security acceleration for ECC implementing the ECDSA algorithm Compliant with 1609.2 IEEE/WAVE (for US) and ETSI TS-103-097 (for EU)
Auxiliary ADC	For transmit power control and antenna diagnostics

Software features

Wi-Fi operational modes	802.11 a station V2X single and dual (concurrent) channel Channel switching support (1609.4) Congestion control (DCC) metrics reporting Timing synchronization support
Host support	Linux, QNX, AUTOSAR host SDK, drivers, and libraries
Security	Secure boot

Interfaces

Host	1 Ethernet (RGMII/MII/Reverse MII) 1 SDIO v3.0, speed up to 200 Mbps 1 SPI, speed up to 24 Mbps
Flash interface	1 Quad/Octal SPI
GNSS interface	1 I ² C, normal and fast modes 4 UART, speed up to 4 Mbs 1 PPS
Other interfaces	20 GPIOs 1 RESET

Package

Dimensions	9.0 x 11.0 x 1.04 mm
Mounting	FCBGA, 357 pins

Environmental data, quality & reliability

Operating temperature	-40 °C to +105 °C
Storage temperature	TBD
Humidity	MSL 3 (Planned)
RoHS compliant (lead-free) and green (no halogens)	
Automotive qualification according to AEC-Q100 Grade 2	
Manufactured in ISO/TS 16494 certified production sites	

Electrical data

Voltage supply	3.3 V
Power consumption	1 W (max)

Certifications and approvals*

Europe (ETSI Radio Equipment Directive (RED))
USA (FCC CFR parts 15, 90 (RSU), and 95 (OBU))
Japan (Giteki)

* Pending approvals

Support products

Evaluation Kit	UBX-P3031 Development Platform with Computer on Module (CoM) interfaces supporting various host CPUs
----------------	--

Product variants

UBX-P3011-BA	V2X chip, automotive grade chip with one single antenna
UBX-P3021-BA	V2X chip, automotive grade chip with dual antenna, single channel with diversity
UBX-P3031-BA	V2X chip, automotive grade chip with dual antenna, concurrent dual channel without diversity

Positioning and timing modules





Standard precision GNSS modules and System-in-Packages (SiPs)

The u-blox M9, u-blox M8 and u-blox 8 modules and SiPs deliver a wide range of innovative features to mass market meter-level Global Navigation Satellite Systems (GNSS) positioning.

Modules and SiPs provide long-term sustainability using shared form factors and offer easy migration to high precision, dead reckoning and timing technologies. SiPs (System in Package) are optimized for size, weight, and power.

u-blox M9: Enhanced GNSS positioning performance

u-blox M9 products acquire and track four GNSS systems concurrently (GPS, GLONASS, BeiDou, and Galileo) to achieve high positional accuracy even in difficult conditions. The u-blox M9 receivers feature special filtering against RF interference and jamming plus spoofing detection and algorithms.

u-blox M8: High performance concurrent GNSS positioning

u-blox M8 products acquire and track three GNSS systems concurrently. Optimized signal reception in combination with software algorithms, advanced tracking and search engines capitalize on the quality, as well as quantity of satellites used. This enables favorable solutions in GNSS-hostile environments.

u-blox 8: Low-power, competitive single GNSS positioning

u-blox 8 is the benchmark in the market for accurate, low-power single-GNSS operation, the economical choice for small battery-powered asset or vehicle tracking devices.

Super-E mode: Ideal balance between lower power and good performance for portable applications

u-blox Super-Efficient is an intelligent power mode that reduces overall power consumption without impacting positioning performance. It uses only the minimal resources required for tracking and maintaining an accurate position, as opposed to the full-power operation.

High precision GNSS modules

The u-blox high precision product portfolio combines GNSS with Real Time Kinematics (RTK) technology. The ZED-F9P and NEO-M8P modules deliver centimeter-level accuracy at a fraction of cost, size, and power of existing alternatives in the market.

The ZED-F9P positioning module features the new u-blox F9 receiver platform, which provides multi-band GNSS to high volume industrial applications in a compact form factor. By

delivering multi-band RTK, ZED-F9P ensures the highest availability of centimeter-level accuracies, constituted by the quicker convergence times it provides. The single-band NEO-M8P provides a power-efficient RTK solution with centimeter-level accuracies ideally suited to applications operating in an open environment, such as UAV applications.

The high precision technologies pave the path for new navigation applications such as robotics and unmanned vehicles.

Dead reckoning GNSS modules and SiPs

Dead reckoning uses information on absolute speed or distance traveled from the vehicle wheels as well as relative information from accelerometer and gyroscope sensors to provide continuous positioning, even in the absence of good GNSS signals, as in urban canyons. u-blox Automotive Dead Reckoning (ADR) is the technology-of-choice for demanding navigation and V2X applications.

u-blox Untethered Dead Reckoning (UDR) offers many of the advantages of dead reckoning without the need for an electrical connection to the vehicle. This brings the combined benefits of ease of installation and improved urban positioning compared to GNSS-only technology. Application examples include aftermarket insurance, telematics, (motor) bikes, car sharing, fleet & asset management, or road tolling.

Timing modules

By capitalizing on atomic clocks onboard positioning satellites, GNSS signals can be used to synchronize equipment to within a few nanoseconds. For some wireless communication standards, a precision time reference is essential and for 5G it enables enhancements to coverage and capacity. For these and other applications, GNSS signals can provide an accurate reference frequency to within 1 part in 100 billion and phase to a fraction of a microsecond.

u-blox's range of multi-band and multi-GNSS precision timing modules are able to fulfill this important reference function for a fraction of the cost, power consumption, maintenance, size and weight of other technologies with comparable performance. These stand-alone products provide accurate time pulses wherever GNSS signals are available, as well as precise disciplined frequency references with hold-over.

ZED-F9P module

u-blox F9 high precision GNSS module

Multi-band receiver delivers centimeter-level accuracy in seconds

- Concurrent reception of GPS, GLONASS, Galileo and BeiDou
- Multi-band RTK with fast convergence times and reliable performance
- High update rate for highly dynamic applications
- Centimeter accuracy in a small and energy-efficient module
- Easy integration of RTK for fast time-to-market



17.0 × 22.0 × 2.4 mm

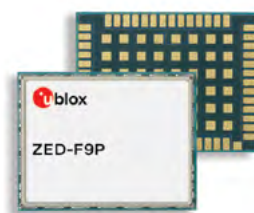

Product description

The ZED-F9P positioning module features the new u-blox F9 receiver platform, which provides multi-band GNSS to high-volume industrial applications in a compact form factor. ZED-F9P is a multi-band GNSS module with integrated u-blox multi-band RTK technology for centimeter-level accuracy. The module enables precise navigation and automation of moving industrial machinery by means of a small, surface-mounted module.

The ZED-F9P module is designed for easy integration and low design-in costs with minimal e-BOM. Thanks to its small package size, light weight, and small power consumption it is well-suited for mass market adoption.

ZED-F9P ensures the security of positioning and navigation information by using secure interfaces and advanced jamming and spoofing detection technologies.

ZED-F9P offers support for a range of correction services allowing each application to optimize performance according to the application's individual need. ZED-F9P comes with built-in support for standard RTCM corrections, supporting centimeter-level navigation from local base stations or from virtual reference stations (VRS) in a Network RTK setup. The module can be upgraded to support future SSR-type correction services suitable for mass market penetration.

u-blox modules are manufactured in ISO/TS 16949 certified sites and are fully tested on a system level. Qualification tests are performed as stipulated in the ISO16750 standard: "Road vehicles – Environmental conditions and testing for electrical and electronic equipment".

ZED-F9P

	ZED-F9P
Grade	
Automotive	
Professional	•
Standard	
GNSS	
GPS / QZSS	•
GLONASS	•
Galileo	•
BeiDou	•
Number of concurrent GNSS	4
Multi-band	•
Interfaces	
UART	2
USB	1
SPI	1
DDC (I2C compliant)	1
Features	
Programmable (flash)	•
Data logging	•
Carrier phase output	•
Additional SAW	•
RTC crystal	•
Oscillator	T
RTK rover	•
RTK base station	•
Moving base	•
Survey-in and fixed mode	•
Timepulse	1
Power supply	
2.7 V – 3.6 V	•

T = TCXO



Features

Receiver type	184-channel u-blox F9 engine GPS L1C/A L2C, GLO L1OF L2OF, GAL E1B/C E5b, BDS B1I B2I, QZSS L1C/A L2C	
Nav. update rate	RTK	up to 20 Hz ¹
Position accuracy ²	RTK	0.01 m + 1 ppm CEP
Convergence time ²	RTK	< 10 sec
Acquisition	Cold starts	24 s
	Aided starts	2 s
	Reacquisition	2 s
Sensitivity	Tracking & Nav.	-167 dBm
	Cold starts	-148 dBm
	Hot starts	-157 dBm
	Reacquisition	-160 dBm
Assistance	AssistNow Online OMA SUPL & 3GPP compliant	
Oscillator	TCXO	
RTC crystal	Built-In	
Anti-jamming	Active CW detection and removal Onboard band pass filter	
Anti-spoofing	Advanced anti-spoofing algorithms	
Memory	Flash	
Moving base	For attitude sensing and heading applications	
Supported antennas	Active	

- 1 The highest navigation rate can limit the number of supported constellations
 2 Depends on atmospheric conditions, baseline length, GNSS antenna, multipath conditions, satellite visibility, and geometry

Interfaces

Serial interfaces	2 UART 1 SPI 1 USB 1 DDC (I2C compliant)
Digital I/O	Configurable timepulse EXTINT input for wakeup RTK fix status GEOFENCE status
Timepulse	Configurable: 0.25 Hz to 10 MHz
Protocols	NMEA, UBX binary, RTCM version 3.3

Package

54-pin LGA (Land Grid Array)
17 x 22 x 2.4 mm

Environmental data, quality & reliability

Operating temp.	-40 °C to +85 °C
Storage temp.	-40 °C to +85 °C
RoHS compliant	(2015/863/EU)
Green	(halogen-free)
EU Radio Equipment Directive	compliant 2014/53/EU
Qualification	according to ISO 16750
Manufactured and fully tested in	ISO/TS 16949 certified production sites
High vibration and shock	resistance

Electrical data

Supply voltage	2.7 V to 3.6 V
Power consumption	68 mA @ 3.0 V (continuous)
Backup supply	1.65 V to 3.6 V

Support products

u-blox support products provide reference design, and allow efficient integration and evaluation of u-blox positioning technology.

C099-F9P	u-blox ZED-F9P application board, with ODIN-W2 for connectivity. Includes multi-band antenna (ANN-MB). One board per package.
----------	---

Product variants

ZED-F9P	u-blox F9 high precision GNSS module with rover and base functionality
---------	--

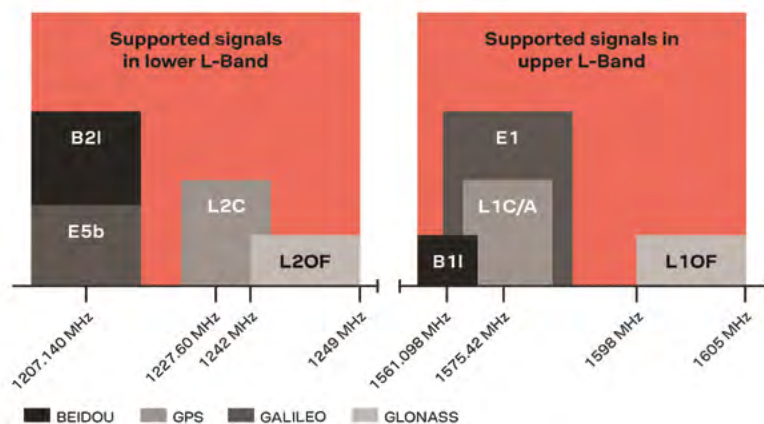



ZED-F9K module

High precision dead reckoning with integrated IMU sensors

Continuous lane accurate positioning under the most challenging conditions

- Decimeter level accuracy for automotive mass markets
- Ideal for ADAS, V2X and head-up displays
- Turnkey multi-band RTK solution with built-in inertial sensors
- Low latency position update rate of up to 30 Hz

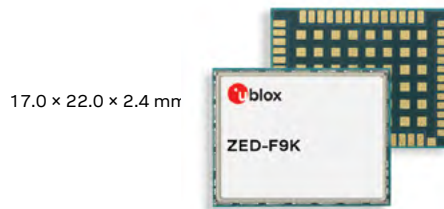

Product description

The ZED-F9K module features the u-blox F9 GNSS receiver to provide continuous decimeter-level positioning accuracy in the most challenging automotive use cases. The wide bandwidth of the multi-band receiver and its ability to simultaneously use all four GNSS constellations enables it to receive many satellite signals even in cities. This brings the highest availability of RTK solutions, everywhere and convergence time within seconds.

It is the first dead reckoning module with an integrated inertial measurement unit (IMU) capable of high precision positioning. The sophisticated built-in algorithms cleverly fuse the IMU data, GNSS measurements, wheel ticks, and vehicle dynamics model to provide lane accurate positioning where GNSS alone would fail. The module operates under open-sky motorways, in the wooded countryside, in difficult urban environments, and even in tunnels and underground parking. In modern automotive applications, such as an advanced driver assistance system (ADAS) to improve road safety, ZED-F9K is the ultimate solution.

The device is a self-contained solution, which provides the best possible system performance to address latency constraints, RF front-end design issues, RTK algorithm integration, etc. This eliminates the technical risk and effort of selecting and integrating RF components and third party libraries like positioning engines. The u-blox approach also dramatically reduces supply chain complexity during production.

ZED-F9K is ideal for innovative automotive designs with space and power limits. The module can be easily integrated into a telematics control unit (TCU), navigation system, ADAS or V2X electronic control unit (ECU). The module reaches a high navigation rate of up to 30 Hz with low latency suitable for real time applications to provide a lag-free user experience. ZED-F9K modules are manufactured in ISO/TS 16949 certified sites and are fully tested. Qualification tests are performed as stipulated in the ISO 16750 standard: "Road vehicles – Environmental conditions and testing for electrical and electronic equipment".

	ZED-F9K
Grade	
Automotive	•
Professional	
Standard	
GNSS	
GPS / QZSS	•
GLONASS	•
Galileo	•
BeiDou	•
Number of concurrent GNSS	4
Multi-band	•
Interfaces	
UART	2
USB	1
SPI	1
DDC (I ² C compliant)	1
Features	
Programmable (Flash)	•
Data logging	
Carrier phase output	
Additional SAW	•
RTC crystal	•
Oscillator	T
RTK rover	•
RTK base station	
Moving base	
Survey-in and fixed mode	
Timepulse	1
Power supply	
2.7 V – 3.6 V	•

T = TCXO



Features

Receiver type	184-channel u-blox F9 engine GPS L1C/A L2C, GLO L1OF L2OF, GAL E1B/C E5b, BDS B1I B2I, QZSS L1C/A L2C	
Nav. update rate	up to 30 Hz	
Position accuracy	RTK	< 0.2 m + 1 ppm CEP
ADR position error	< 2% of distance travelled without GNSS	
Convergence time	RTK	< 10 s
Acquisition	Cold starts	24 s
	Aided starts	4 s
	Reacquisition	2 s
Sensitivity	Tracking & nav. ¹	-160 dBm
	Cold starts	-147 dBm
	Hot starts	-158 dBm
Built-in	TCXO, RTC, flash memory, 3D accelerometer, 3D gyroscope, diplexer, SAW filters	
Supported antennas	Active	

1 Limited by firmware for best DR performance

Software features

Assistance	AssistNow Online OMA SUPL & 3GPP compliant	
Anti-jamming	Active CW detection and removal Onboard band pass filter	
Anti-spoofing	Advanced anti-spoofing algorithms	
Raw data	Code and Doppler measurements and IMU data	
Protocols	NMEA, UBX binary, RTCM version 3.3	

Interfaces

Serial interfaces	2 UART 1 USB 1 SPI (optional) 1 DDC (I ² C compliant)	
Digital I/O	Configurable timepulse	
Timepulse	Configurable: 0.25 Hz to 10 MHz	

Electrical data

Supply voltage	2.7 V to 3.6 V	
Power consumption	85 mA @ 3.0 V (continuous)	
Backup supply	1.65 V to 3.6 V	

Package

54-pin LGA (Land Grid Array)
17 x 22 x 2.4 mm

Environmental data, quality & reliability

Operating temp.	-40 °C to +105 °C	
Storage temp.	-40 °C to +105 °C	
RoHS compliant (lead-free, 2015/863/EU)		
Green (halogen-free)		
EU Radio Equipment Directive compliant 2014/53/EU		
Qualification according to ISO 16750		
Manufactured and fully tested in ISO/TS 16949 certified production sites		
Uses u-blox F9 chips qualified according to AEC-Q100		

Support products

C100-F9K	Easy to use evaluation board with various communication interfaces for correction services
----------	--

Product variants

ZED-F9K	u-blox F9 multi-band high precision dead reckoning, automotive grade
---------	--



ZED-F9R module

Fully integrated high precision sensor fusion solution

High precision sensor fusion for ultimate performance

- Continuous navigation in most challenging environments
- Low latency and high update rate for real time applications
- Fully integrated solution for fast time-to-market
- Fast RTK convergence times
- Full GNSS raw data support

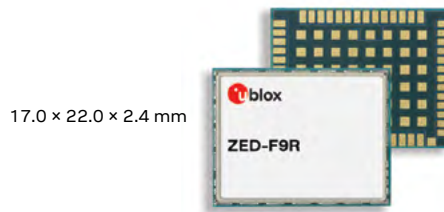

Product description

The ZED-F9R positioning module features the u-blox F9 receiver platform providing a reliable multi-band GNSS sensor fusion solution for industrial applications in a compact form factor. The wide bandwidth allows to receive many satellites in parallel, resulting in high availability of RTK solutions and quick convergence time.

The high performance sensor fusion module has an integrated inertial measurement unit (IMU) for RTK positioning. The sophisticated built-in algorithms fuse the IMU data, GNSS measurements, wheel ticks, correction data, and a vehicle dynamics model to provide optimal positioning accuracy where GNSS alone would fail.

The module operates under open sky, in the wooded countryside, in difficult multipath environments, and even in covered areas. Designed for autonomous industrial applications like agricultural machinery or heavy trucks, ZED-F9R is the ultimate solution for modern autonomous industrial applications where control and position availability are key to success.

The device is a turnkey self-contained solution, which provides the best possible performance: no latencies or similar system considerations to worry about. This eliminates the technical risk and effort of selecting and integrating RF components and third-party libraries such as precise positioning engines. ZED-F9R offers support for a range of correction services allowing each application to optimize performance according to the application's unique needs. ZED-F9R comes with built-in support for RTCM-formatted corrections, enabling high precision navigation using internet or satellite data connectivity.

The ZED-F9R modules use GNSS chips qualified according to AEC-Q100 and are manufactured in ISO/TS 16949 certified sites. Qualification tests are performed as stipulated in the ISO16750 standard: "Road vehicles – Environmental conditions and testing for electrical and electronic equipment". The ZED-F9R-00B professional grade module adheres to industrial standard quality specifications and production flow.

ZED-F9R

	ZED-F9R
Grade	
Automotive	
Professional	•
Standard	
GNSS	
GPS / QZSS	•
GLONASS	•
Galileo	•
BeiDou	•
Number of concurrent GNSS	4
Multi-band	•
Interfaces	
UART	2
USB	1
SPI	1
DDC (I2C compliant)	1
Features	
Programmable (flash)	•
Data logging	•
Carrier phase output	•
Additional SAW	•
RTC crystal	•
Oscillator	T
RTK rover	•
RTK base station	
Moving base	
Survey-in and fixed mode	
Timepulse	1
Power supply	
2.7 V – 3.6 V	•

T = TCXO



Features

Receiver type	184-channel u-blox F9 engine GPS L1C/A L2C, GLO L1OF L2OF, GAL E1B/C E5b, BDS B1I B2I, QZSS L1C/A L2C	
Nav. update rate	Up to 30 Hz	
Position accuracy	RTK	< 0.2 m + 1 ppm CEP
ADR position error	< 2% of distance traveled without GNSS	
Convergence time	RTK	<10 s
Acquisition	Cold starts	24 s
	Aided starts	4 s
	Reacquisition	2 s
Built-in	TCXO, RTC, flash memory, 3D accelerometer, 3D gyroscope, diplexer, SAW filters	
Sensitivity	Tracking & nav. ¹	-160 dBm
	Cold starts	-147 dBm
	Hot starts	-158 dBm
Supported antennas	Active	

¹ Limited by firmware for best DR performance

Software features

Assistance	AssistNow Online OMA SUPL & 3GPP compliant	
Anti-jamming	Active CW detection and removal Onboard band pass filter	
Anti-spoofing	Advanced anti-spoofing algorithms	
Raw data	Carrier phase, Code phase, Pseudoranges, IMU data output	
Protocols	NMEA, UBX binary, RTCM version 3.3	

Interfaces

Serial interfaces	2 UART 1 USB 1 SPI (optional) 1 DDC (I2C compliant)	
Digital I/O	Configurable timepulse	
Timepulse	Configurable: 0.25 Hz to 10 MHz	

Electrical data

Supply voltage	2.7 V to 3.6 V	
Power consumption	85 mA at 3.0 V (continuous)	
Backup supply	1.65 V to 3.6 V	

Package

54-pin LGA (Land Grid Array)
17 x 22 x 2.4 mm

Environmental data, quality & reliability

Operating temp.	-40 °C to +85 °C	
Storage temp.	-40 °C to +85 °C	
RoHS compliant (lead-free, 2015/863/EU)		
Green (halogen-free)		
ETSI-RED compliant		
Qualification according to ISO 16750		
Manufactured and fully tested in ISO/TS 16949 certified production sites		
Uses u-blox F9 chips qualified according to AEC-Q100		

Support products

C102-F9R	Easy to use evaluation board with various communication interfaces
----------	--

Product variants

ZED-F9R-00B	u-blox F9 dual band GNSS module with high precision sensor fusion
-------------	---



ZED-F9H module

u-blox F9 high precision GNSS module

u-blox F9 module designed for heading applications

- Precise heading information to all types of vehicles
- Suitable for UAV, trucks, heavy vehicles and antenna alignment applications
- Heading accuracy independent of vehicle motion and calibration



17.0 × 22.0 × 2.4 mm

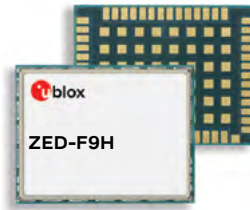

Product description

The ZED-F9H module is designed to provide best possible heading information to applications where precise attitude is of greatest importance.

The ZED-F9H acts as an accompanying module, and requires a ZED-F9P module to be mounted on the same vehicle. In this setup, ZED-F9P provides the precise GNSS position, and at the same time acts as a moving base to the ZED-F9H module, which in turn outputs the precise attitude information.

As the heading information is based on GNSS it does not require pre-calibration, thus ensuring easy production, integration and operation. The precise heading information is always available, even in stand-still situations.

ZED-F9H is designed to lower the system cost for a heading application and comes with minimal e-BOM. Thanks to its small package size, light weight, and low power consumption it is well-suited for mass market adoption.

u-blox modules are manufactured in ISO/TS 16949 certified sites and are fully tested on a system level. Qualification tests are performed as stipulated in the ISO16750 standard: "Road vehicles – Environmental conditions and testing for electrical and electronic equipment".

ZED-F9H

	ZED-F9H
Grade	
Automotive	
Professional	•
Standard	
GNSS	
GPS / QZSS	•
GLONASS	•
Galileo	•
BeiDou	•
Number of concurrent GNSS	4
Multi-band	•
Interfaces	
UART	2
USB	1
SPI	1
DDC (I2C compliant)	1
Features	
Programmable (flash)	•
Data logging	•
Carrier phase output	
Additional SAW	•
RTC crystal	•
Oscillator	T
RTK rover	
RTK base station	
Timepulse	1
Power supply	
2.7 V – 3.6 V	•

T = TCXO



Features

Receiver type	184-channel u-blox F9 engine GPS L1C/A L2C, GLO L1OF L2OF, GAL E1B/C E5b, BDS B1I B2I, QZSS L1C/A L2C	
Heading accuracy ¹	0.4 degrees	
Heading update rate ²	Up to 10 Hz	
Acquisition	Cold starts	24 s
	Aided starts	2 s
	Reacquisition	2 s
Sensitivity	Tracking & Nav.	-167 dBm
	Cold starts	-148 dBm
	Hot starts	-157 dBm
	Reacquisition	-160 dBm
Oscillator	TCXO	
RTC crystal	Built-In	
Anti-jamming	Active CW detection and removal Onboard band pass filter	
Anti-spoofing	Advanced anti-spoofing algorithms	
Memory	Flash	
Supported antennas	Active	

1 50%, measured with 1 m baseline and patch antennas with good ground planes
2 The highest navigation rate can limit the number of supported constellations

Interfaces

Serial interfaces	2 UART	
	1 SPI	
	1 USB	
	1 DDC (I2C compliant)	
Digital I/O	Configurable timepulse EXTINT input for wakeup RTK fix status	
Timepulse	Configurable: 0.25 Hz to 10 MHz	
Protocols	NMEA, UBX binary, RTCM version 3.3	

Package

54-pin LGA (Land Grid Array)
17 x 22 x 2.4 mm

Environmental data, quality & reliability

Operating temp. -40 °C to +85 °C

Storage temp. -40 °C to +85 °C

RoHS compliant (2015/863/EU)

Green (halogen-free)

EU Radio Equipment Directive compliant 2014/53/EU

Qualification according to ISO 16750

Manufactured and fully tested in ISO/TS 16949 certified production sites

High vibration and shock resistance

Electrical data

Supply voltage 2.7 V to 3.6 V

Power consumption 68 mA at 3.0 V (continuous)

Backup supply 1.65 V to 3.6 V

Support products

u-blox support products provide reference design, and allow efficient integration and evaluation of u-blox positioning technology.

C099-F9P u-blox ZED-F9P application board, with ODIN-W2 for connectivity. Includes multi-band antenna (ANN-MB). One board per package. See product documentation for more details.

Product variants

ZED-F9H u-blox F9 precision heading GNSS module



NEO-D9S series

u-blox D9 correction data receiver

First mass-market L-band GNSS correction module

- Access to centimeter-level GNSS corrections globally
- Freedom to select GNSS correction data delivery channel
- High scalability for industrial and automotive applications
- Allows selection of desired L-band GNSS correction service
- Easy hardware integration and configuration

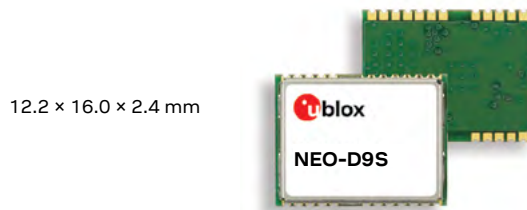

Product description

NEO-D9S is a satellite data receiver for L-band correction broadcast, which can be configured for use with a variety of correction services. It decodes the satellite transmission, which can be decrypted and converted to corrections on the host processor, enabling a high precision GNSS receiver to reach accuracies down to centimeter level. NEO-D9S ensures high availability of the position output and decreases dependence on cellular connectivity for correction service delivered both via IP and satellite L-band, by providing an independent second correction data stream. Granting access to a broadcast data stream, NEO-D9S allows virtually infinite scalability, eliminating the need for a dedicated delivery channel per user. This makes NEO-D9S flexible for use in various markets and applications.

NEO-D9S is configurable for use with correction data of various providers and service levels. This ensures high precision in multiple regions globally, as well as coverage across continents.

NEO-D9S can be easily integrated with a variety of high precision GNSS receivers from the u-blox F9 platform, which allows a complete high precision solution to be built with less design effort. For more information about the u-blox F9 products, refer to the u-blox website.

In addition, NEO-D9S can be integrated in any high precision GNSS system that uses L-band correction delivery.

The NEO-D9S implements u-blox security principles and advanced security features including signature, anti-jamming, and anti-spoofing mechanisms, thus allowing reliable GNSS positioning in end-user products.

This L-band receiver is in the u-blox NEO form factor.

	NEO-D9S-00A	NEO-D9S-00B
Grade		
Automotive	•	
Professional		•
Standard		
GNSS		
Satellite L-band	•	•
Concurrent signals	1	1
Concurrent satellites	2	2
Interfaces		
UART	2	2
USB	1	1
SPI	1	1
DDC (I2C compliant)	1	1
Features		
Programmable (flash)	•	•
Additional SAW filter	•	•
RTC crystal	•	•
Oscillator	T	T
Active antenna / LNA supply	•	•
Power supply		
1.65 V – 3.6 V	•	•

T = TCXO

Features

Receiver type	u-blox D9 correction data receiver	
Time-to-first-frame	Initial acquisition at 2400 bit/s	<10 s
Acquisition sensitivity	For BER < 10e-5 at 2400 bit/s	-133 dBm
Oscillator	TCXO	
Frequency band	1525-1559 MHz	
Memory	Flash	
Supported antennas	Active	

Security features

Anti-jamming	Active CW detection and removal Onboard SAW band pass filter	
Anti-spoofing	Advanced anti-spoofing algorithms	
Firmware update	Signature mechanism	

High precision GNSS architecture

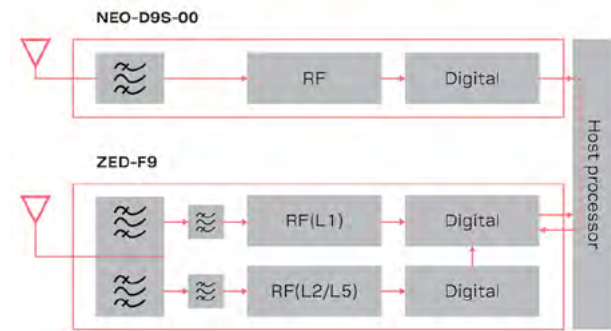

Interfaces

Serial interfaces	2 UARTs 1 USB 1 SPI 1 DDC (I2C compliant)
Protocols	UBX
Digital I/O	1 EXTINT input for Wakeup

Electrical data

Supply voltage	2.7 V to 3.6 V
Power consumption	35 mA at 3.0 V (average)

Package

24-pin LCC (Leadless Chip Carrier) 12.2 x 16.0 x 2.4 mm, 1.6 g

Environmental data, quality & reliability

	NEO-D9S-00A	NEO-D9S-00B
Operating temp.	-40 °C to +85 °C	-40 °C to +85 °C
Storage temp.	-40 °C to +85 °C	-40 °C to +85 °C
RoHS compliant (lead-free)	Yes	
Green (halogen-free)	Yes	
ETSI-RED compliant	Yes	
Qualification according to ISO 16750	Yes	
Manufactured and fully tested in ISO/TS 16949 certified production sites	Yes	
High vibration and shock resistance	Yes	
Based on u-blox chips qualified according to AEC-Q100	Yes	

Support products

Evaluation kits provide reference design, and allow efficient integration and evaluation of u-blox positioning technology.	
C101-D9S	NEO-D9S application board, allowing the module to be evaluated as stand-alone or combined with the C099-F9P application board for use with ZED-F9P. Includes L-band antenna
C100-F9K	Application board with ZED-F9K high precision GNSS receiver, allowing inclusion of NEO-D9S for satellite L-band correction data reception.

Product variants

NEO-D9S-00A	u-blox D9 correction data receiver with satellite L-band raw output, automotive grade
NEO-D9S-00B	u-blox D9 correction data receiver with satellite L-band raw output, professional grade



NEO-M8P series

u-blox M8 high precision GNSS modules



Standard



Professional



Automotive

Centimeter accuracy for mass market applications

- Integrated Real Time Kinematics (RTK) for fast time-to-market
- Small, light, and energy-efficient RTK module
- Complete and versatile solution due to base and rover variants
- World-leading GNSS positioning technology

12.2 × 16.0 × 2.4 mm



Product description

The NEO-M8P module combines the high performance u-blox M8 positioning engine with u-blox's Real Time Kinematic (RTK) technology. The NEO-M8P provides cm-level GNSS performance designed to meet the needs of unmanned vehicles and other machine control applications requiring high precision guidance.

u-blox's RTK technology introduces the concept of a "rover" (NEO-M8P-0) and a "base" (NEO-M8P-2) on the M8 platform for stunning cm-level accuracy in clear sky environments. The base station module sends corrections via the RTCM protocol to the rover module via a communication link enabling the rover to output its position relative to the base station down to centimeter-level precision.

The NEO-M8P is ideal for applications that require vehicles to move faster and more accurately, operate more efficiently, and automatically return to base station platforms. Such applications include UAV, unmanned vehicles (e.g. robotic lawn mowers), and Precision Agriculture guidance.

The module enables system integrators to access u-blox's complete end-to-end RTK solution, including the stationary "survey-in" functionality that is designed to reduce the setup time and increase the flexibility of the application.

NEO-M8P includes moving base, allowing both base and rover to move while computing a centimeter-level accurate position between them. Moving base is ideal for UAV applications where the UAV is programmed to follow its owner or to land on a moving platform. It is also well suited to attitude sensing applications where both base and rover modules are mounted on the same moving platform and the relative position is used to derive attitude information for the vehicle or tool.

NEO-M8P modules are compatible with a wide range of communication technologies (Cellular, Wi-Fi, Bluetooth, UHF) enabling the user to select the communication link best suited to their application. With u-blox's RTK technology, integration and software development efforts can be reduced, ensuring a minimal cost of ownership.

u-blox M8 modules use GNSS chips qualified according to AEC-Q100, are manufactured in ISO/TS 16949 certified sites, and fully tested on a system level. Qualification tests are performed as stipulated in the ISO16750 standard: "Road vehicles – Environmental conditions and testing for electrical and electronic equipment".

	NEO-M8P-0	NEO-M8P-2
Grade		
Automotive		
Professional	•	•
Standard		
GNSS		
GPS / QZSS	•	•
GLONASS	•	•
Galileo		
BeiDou	•	•
Number of concurrent GNSS	2	2
Interfaces		
UART	1	1
USB	1	1
SPI	1	1
DDC (I ² C compliant)	1	1
Features		
Programmable (Flash)	•	•
Data logging	•	•
Carrier phase output	•	•
Additional SAW	•	•
Additional LNA	•	•
RTC crystal	•	•
Oscillator	T	T
RTK rover	•	•
RTK base station		•
Moving base	•	•
Survey-in and fixed mode		•
Timepulse	1	1
Power supply		
2.7 V – 3.6 V	•	•

T = TCXO

Features

Receiver type	72-channel u-blox M8 engine GPS L1 C/A, GLONASS L1OF, BeiDou B1I	
Nav. update rate	RTK:	up to 8 Hz ¹
	Carrier phase data:	up to 10 Hz
Positioning accuracy ²	Standalone	2.5 m CEP
	RTK	0.025 m + 1 ppm CEP ³
Convergence time ²	RTK	< 60 sec
Acquisition		
Cold starts:	26 s	
Aided starts:	2 s	
Reacquisition:	1 s	
Sensitivity		
Tracking & Nav.:	-160 dBm	
Cold starts:	-148 dBm	
Hot starts:	-156 dBm	
Reacquisition:	-158 dBm	
Assistance	AssistNow GNSS Online OMA SUPL & 3GPP compliant	
Oscillator	TCXO	
Noise figure	On-chip LNA with extra LNA for lowest noise figure	
Anti jamming	Active CW detection and removal; extra onboard SAW band pass filter.	
Memory	Flash	
Supported antennas	Active and passive	
Moving base	For moving base stations, attitude sensing and "follow-me" applications	
Survey-in base station	For generating sub-meter base station positions (for NEO-M8P-2)	

- 1 Limited to 5 Hz for multi-GNSS RTK and to 4Hz in moving baseline configuration
- 2 Depends on atmospheric conditions, baseline length, GNSS antenna, multipath conditions, satellite visibility, and geometry
- 3 ppm limited to baselines up to 10 km

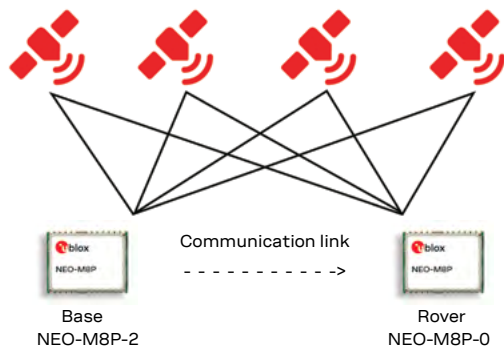

Package

24 pin LCC (Leadless Chip Carrier): 12.2 x 16.0 x 2.4 mm, 1.6 g

Environmental data, quality & reliability

Operating temp.	-40 °C to +85 °C
Storage temp.	-40 °C to +85 °C
RoHS compliant (lead-free)	
Qualification according to ISO 16750	
Manufactured and fully tested in ISO/TS 16949 certified production sites	
Uses u-blox M8 chips qualified according to AEC-Q100	

Interfaces

Serial interfaces	1 UART 1 USB V2.0 full speed 12 Mbit/s 1 SPI (optional) 1 DDC (I ² C compliant)
Digital I/O	Configurable timepulse 1 EXTINT input for Wakeup RTK Fix Status GEOFENCE Status
Timepulse	Configurable: 0.25 Hz to 10 MHz
Protocols	NMEA, UBX binary, RTCM version 3.x

Electrical data

Supply voltage	2.7 V to 3.6 V
Power Consumption	25 mA @ 3.0 V (continuous, GPS only)
Backup Supply	1.4 V to 3.6 V

Support products

Application board provides reference design, and allows efficient integration and evaluation of u-blox M8 high precision GNSS technology.

C94-M8P Two application boards, each with NEO-M8P-2 (rover and base station functionality), for evaluating RTK applications

Product variants

NEO-M8P-0	u-blox M8 high precision module with rover functionality
NEO-M8P-2	u-blox M8 high precision module with rover and base functionality



NEO-M8L series

u-blox M8 ADR modules with 3D sensors

Continuous accurate navigation under all signal conditions

- Integrated 3D sensors with speed information from the vehicle
- Continuous navigation during signal loss
- Automatic configuration of wheel-tick/speed input
- Real-time positioning up to 30 Hz rate
- GPS/QZSS, GLONASS, BeiDou, Galileo
- Zero PPM program for automotive grade NEO-M8L-04A
- Supports ADR and UDR modes



12.2 × 16.0 × 2.4 mm



Product description

The NEO-M8L 3D Automotive Dead Reckoning (ADR) modules combine GNSS, inertial sensing, and speed information from the vehicle to provide continuous and accurate positioning for telematics, navigation and V2X applications. The position engine tolerates missing wheel sensor data and also supports UDR mode without any wheel sensor data.

Incorporating u-blox's latest advancements in multi-GNSS signal processing, the latest version of NEO-M8L delivers the ideal solution where navigation performance is the priority, regardless of GNSS signal quality or availability. In addition to the on-board sensors, NEO-M8L further eases installation with automatic configuration of speed or wheel-tick inputs, and compensation for in-vehicle antennas.

The intelligent combination of GNSS and sensor measurements enables accurate, real-time positioning, speed and heading information at rates up to 30 Hz, as essential for smooth and responsive interactive display. Access to native, high-rate sensor data enables host applications to make full use of the receiver's assets.

The NEO-M8L includes u-blox's latest generation GNSS technology with multi-constellation reception including Galileo, GPS, GLONASS, BeiDou and QZSS. The module provides high sensitivity and fast GNSS signal acquisition and tracking.

UART, USB, DDC (I2C compliant) and SPI interface options provide flexible connectivity and enable simple integration with most u-blox cellular modules.

NEO-M8L modules use GNSS chips qualified according to AEC-Q100 and are manufactured in ISO/TS 16949 certified sites. Qualification tests are performed as stipulated in the ISO16750 standard: "Road vehicles – Environmental conditions and testing for electrical and electronic equipment".

The NEO-M8L-04A automotive grade module adheres to automotive industry standard quality specifications and production flow.

	NEO-M8L-04A	NEO-M8L-04B
Grade		
Automotive	•	
Professional		•
Standard		
GNSS		
GPS / QZSS	•	•
GLONASS	•	•
Galileo	•	•
BeiDou	•	•
Number of concurrent GNSS	3	3
Interfaces		
UART	1	1
USB	1	1
SPI	1	1
DDC (I ² C compliant)	1	1
Features		
Programmable (Flash)	•	•
Data logging	•	•
RTC crystal	•	•
Oscillator	T	C
Built-in sensor	•	•
Timepulse	1	1
Power supply		
2.7 V – 3.6 V		•
3.0 V – 3.6 V	•	

T = TCXO C = Crystal



Features

Receiver type	72-channel u-blox M8 engine GPS/QZSS L1 C/A, GLONASS L10F BeiDou B1I, Galileo E1B/C SBAS L1 C/A: WAAS, EGNOS, MSAS, GAGAN	
Nav. update rate	up to 30 Hz	
Position accuracy	Autonomous	2.5 m CEP
	with SBAS	1.5 m CEP
ADR position error	2 % of distance travelled without GNSS	
Acquisition		
Cold starts:	26 s	
Aided starts:	3 s	
Reacquisition:	1 s	
Sensitivity		
Tracking & Nav.:	-160 dBm ¹	
Cold starts:	-148 dBm	
Hot starts:	-157 dBm	
Assistance GNSS	AssistNow Online AssistNow Offline (up to 35 days) AssistNow Autonomous (up to 6 days) OMA SUPL & 3GPP compliant	
Oscillator	TCXO (NEO-M8L-04A)	Crystal (NEO-M8L-04B)
RTC	Built-in	
Sensor	Onboard 3D accelerometer and 3D gyroscope	
Supported antennas	Active or passive antenna	
Raw data	Code phase output	
Navigation outputs	Position, speed, acceleration, heading, heading rate, attitude, time	
Data-logger	For position, velocity, time, and odometer data	

¹ = Limited by FW for best DR performance

Electrical data

Supply voltage	3.0 V to 3.6 V (NEO-M8L-04A) 2.7 V to 3.6 V (NEO-M8L-04B)	
Power Consumption	29 mA @ 3.0 V (Continuous, default concurrent mode)	
Backup Supply	1.4 V to 3.6 V	

Package

24 pin LCC (Leadless Chip Carrier): 12.2 x 16.0 x 2.4 mm, 1.6 g

Environmental data, quality & reliability

Operating temp.	-40 °C to +85 °C
Storage temp.	-40 °C to +85 °C
RoHS compliant (lead-free)	
Qualification according to ISO 16750	
Manufactured and fully tested in ISO/TS 16949 certified production sites	
Uses u-blox M8 chips qualified according to AEC-Q100	

Interfaces

Serial interfaces	1 UART 1 USB V2.0 full speed 12 Mbit/s 1 SPI (optional) 1 DDC (I ² C compliant)
Digital I/O	Configurable timepulse
Timepulse	Configurable: 0.25 Hz to 10 MHz
Protocols	NMEA, UBX binary, RTCM

Support products

u-blox M8 Evaluation Kits:

Easy-to-use kits to get familiar with u-blox M8 positioning technology, evaluate functionality, and visualize GNSS performance.

EVK-M8L	u-blox M8 3D Dead Reckoning GNSS Evaluation Kit; supports NEO-M8L modules
---------	---

Product variants

NEO-M8L-04A	u-blox M8 GNSS LCC module with 3D Dead Reckoning and onboard sensors, Automotive Grade
NEO-M8L-04B	u-blox M8 GNSS LCC module with 3D Dead Reckoning and onboard sensors, Professional Grade



NEO-M8U module

u-blox M8 UDR module with 3D sensors

Uninterrupted positioning under all signal conditions using a built-in sensor without need for an electrical connection to the car

- World's first untethered dead reckoning GNSS solution
- Independent of any electrical connection to the car
- Positioning accuracy in dense cities and covered areas
- Complete positioning solution with integrated 3D sensors
- Compatible with all modules of the NEO family
- Real-time positioning update rate of up to 30 Hz



12.2 × 16.0 × 2.4 mm



Product description

The NEO-M8U module introduces u-blox's Untethered Dead Reckoning (UDR) technology, which provides continuous navigation without requiring speed information from the vehicle. This innovative technology brings the benefits of dead reckoning to installations previously restricted to using GNSS alone, and significantly reduces the cost of installation for after-market dead reckoning applications.

The strength of UDR is particularly apparent under poor signal conditions, where it brings continuous positioning in urban environments, even to devices with antennas installed within the vehicle. Useful positioning performance is also available during complete signal loss, for example in parking garages and short tunnels. With UDR, positioning starts as soon as power is applied to the module, before the first GNSS fix is available.

The NEO-M8U may be installed in any position within the vehicle without configuration. In addition to its freedom from any electrical connection to the vehicle, the on-board accelerometer and gyroscope sensors result in a fully self-contained solution, perfect for rapid product development with reliable and consistent performance.

The intelligent combination of GNSS and sensor measurements enables accurate, real-time positioning at rates up to 30 Hz, as is needed for smooth and responsive interactive applications. Native high rate sensor data is made available to host applications such as driving behaviour analysis or accident reconstruction.

The NEO-M8U includes u-blox's latest generation GNSS receiver, which adds Galileo to the multi-constellation reception that already includes GPS, GLONASS, BeiDou and QZSS. The module provides high sensitivity and fast GNSS signal acquisition and tracking. UART, USB, DDC (I²C compliant) and SPI interface options provide flexible connectivity and enable simple integration with most u-blox cellular modules.

u-blox M8 modules use GNSS chips qualified according to AEC-Q100 and are manufactured in ISO/TS 16949 certified sites. Qualification tests are performed as stipulated in the ISO16750 standard: "Road vehicles – Environmental conditions and testing for electrical and electronic equipment".

	NEO-M8U
Grade	
Automotive	
Professional	•
Standard	
GNSS	
GPS / QZSS	•
GLONASS	•
Galileo	•
BeiDou	•
Number of concurrent GNSS	3
Interfaces	
UART	1
USB	1
SPI	1
DDC (I ² C compliant)	1
Features	
Programmable (Flash)	•
Data logging	•
RTC crystal	•
Oscillator	C
Built-in sensor	•
Timepulse	1
Power supply	
2.7 V – 3.6 V	•

C = Crystal



Features

Receiver type	72-channel u-blox M8 engine GPS/QZSS L1 C/A, GLONASS L10F BeiDou B1I, Galileo E1B/C SBAS L1 C/A: WAAS, EGNOS, MSAS, GAGAN
Nav. update rate	up to 30 Hz
Position accuracy	2.5 m CEP
UDR position error	Typically <10% of distance covered without GNSS (up to 60 s)
Acquisition	
Cold starts:	26 s
Aided starts:	3 s
Reacquisition:	1 s
Sensitivity	
Tracking & Nav.:	-160 dBm ¹
Cold starts:	-148 dBm
Hot starts:	-157 dBm
Assistance GNSS	AssistNow Online AssistNow Offline (up to 35 days) AssistNow Autonomous (up to 6 days) OMA SUPL & 3GPP compliant
Oscillator	Crystal
RTC	Built-in
Sensor	Onboard accelerometer and gyroscope
Supported antennas	Active or passive antenna
Raw Data	Code phase output
Odometer	Integrated in navigation filter
Geofencing	Up to 4 circular areas GPIO for waking up external CPU
Spoofing detection	Built-in
Signal integrity	Signature feature with SHA 256
Data-logger	For position, velocity, time, odometer data

1 Limited by FW for best DR performance

Electrical data

Supply voltage	2.7 V to 3.6 V
Power Consumption	29 mA @ 3.0 V (Continuous, default concurrent mode)
Backup Supply	1.4 V to 3.6 V

Package

24 pin LCC (Leadless Chip Carrier): 12.2 x 16.0 x 2.4 mm, 1.6 g

Environmental data, quality & reliability

Operating temp.	-40 °C to +85 °C
Storage temp.	-40 °C to +85 °C
RoHS compliant (lead-free)	
Qualification according to ISO 16750	
Manufactured and fully tested in ISO/TS 16949 certified production sites	
Uses u-blox M8 chips qualified according to AEC-Q100	

Interfaces

Serial interfaces	1 UART 1 USB V2.0 full speed 12 Mbit/s 1 SPI (optional) 1 DDC (I ² C compliant)
Timepulse	Configurable: 0.25 Hz to 10 MHz
Protocols	NMEA, UBX binary, RTCM

Support products

u-blox M8 Evaluation Kits:

Easy-to-use kits to get familiar with u-blox M8 positioning technology, evaluate functionality, and visualize GNSS performance.

EVK-M8U	u-blox M8 Untethered Dead Reckoning GNSS evaluation kit, supports NEO-M8U
---------	---

Product variants

NEO-M8U	u-blox M8 GNSS LCC module with Untethered Dead Reckoning and onboard sensors
---------	--



EVA-M8E SiP

Small u-blox M8 UDR SiP



Standard



Professional



Automotive

Uninterrupted positioning under all signal conditions without need for electrical connection to the car

- Industry's smallest UDR SiP form-factor
- Leading performance under poor signal conditions
- Continuous navigation during signal interruptions
- Independent of any electrical connection to the car
- Real-time positioning at rates up to 30 Hz
- Low cost of ownership, ideal for high volume projects

7.0 × 7.0 × 1.1 mm



Product description

The EVA-M8E SiP introduces u-blox's Untethered Dead Reckoning (UDR) technology in the ultra-compact EVA form-factor. Measuring merely 7 × 7 mm, the EVA-M8E offers the designer flexibility in the selection and placement of peripheral components. The EVA-M8E only requires flash memory, an inertial sensor, and an optional real-time clock (RTC) crystal. The EVA-M8E's sensor may be installed in any stable position within the vehicle without configuration.

UDR provides the benefits of Dead Reckoning (DR) without requiring speed information from the vehicle. This significantly reduces the cost of installation for after-market Dead Reckoning applications and brings DR performance to applications where previously only GNSS was possible. The strength of UDR compared with GNSS alone is particularly apparent under poor signal conditions in urban environments, where it brings continuous positioning even to devices with antennas installed within the vehicle. Useful positioning performance is also available during complete signal loss, for example in parking garages and short tunnels. UDR positioning starts as soon as power is applied to the SiP, even before the first GNSS fix is available. Inertial sensing enables vehicle yaw, pitch, and roll to be calculated and reported directly.

The intelligent combination of GNSS and sensor measurements enables accurate, real-time positioning at rates up to 30 Hz, as needed for smooth and responsive interactive applications. Native high-rate sensor data can be relayed to the host for applications such as driving behaviour analysis or accident reconstruction.

The EVA-M8E includes u-blox's latest generation GNSS receiver, which adds Galileo to the multi-constellation reception that already includes GPS, GLONASS, BeiDou and QZSS. The SiP provides high sensitivity and fast GNSS signal acquisition and tracking. UART, USB, DDC (I²C compliant) and SSI interface options provide flexible connectivity and enable simple integration with most u-blox cellular modules.

EVA-M8E SiPs are qualified as stipulated in the JESD47 standard.

EVA-M8E

Grade	
Automotive	
Professional	•
Standard	
GNSS	
GPS / QZSS	•
GLONASS	•
Galileo	•
BeiDou	•
Number of concurrent GNSS	3
Interfaces	
UART	1
USB	1
SPI	1
DDC (I ² C compliant)	1
Features	
Programmable (Flash)	E
Data logging	E
RTC crystal	o
Oscillator	T
Timepulse	1
Power supply	
2.7 V – 3.6 V	•

o = Optional, or requires external components
E = External Flash Required

T = TCXO



Features

Receiver type	72-channel u-blox M8 engine GPS/QZSS L1 C/A, GLONASS L10F BeiDou B1I, Galileo E1B/C SBAS L1 C/A: WAAS, EGNOS, MSAS, GAGAN
Nav. update rate	Up to 30 Hz
Position accuracy ¹	2.5 m CEP
Acquisition ¹	
Cold starts:	26 s
Aided starts:	3 s
Reacquisition:	1 s
Sensitivity ¹	
Tracking & Nav:	-160 dBm
Cold starts:	-148 dBm
Hot starts:	-157 dBm
Assistance GNSS	AssistNow Online AssistNow Offline (up to 35 days) AssistNow Autonomous (up to 6 days) OMA SUPL & 3GPP compliant
Oscillator	TCXO
Real time clock (RTC)	Can be derived from external crystal or RTC Clock
SQI flash	Required
Sensor	External DDC gyro/accelerometer required
Supported antennas	Active and passive ³
Antenna supervision	Short and open circuit detection supported with external circuit
Raw Data	Code phase output
Odometer	Integrated in navigation filter
Geofencing	Up to 4 circular areas GPIO for waking up external CPU
Spoofing detection	Built-in
Signal integrity	Signature feature with SHA 256
Data-logger ⁴	For position, velocity, time, and odometer data

¹ For default mode: GPS/SBAS/QZSS+GLONASS

² Limited by FW for best DR performance

³ An external LNA and SAW recommended for passive antenna applications

⁴ External flash required

Environmental data, quality & reliability

Operating temp.	-40 °C to +85 °C
RoHS compliant (lead-free) and green (no halogens)	
Qualification according to standard JESD47	
Moisture sensitivity level 3	

Package

43 pin LGA (Land Grid Array): 7.0 x 7.0 x 1.1 mm, 0.13 g

Electrical data

Supply voltage	2.7 V to 3.6 V
Power consumption ⁴	29 mA @ 3.0 V (Continuous, default concurrent mode)
Backup Supply	1.4 V to 3.6 V

Interfaces

Serial interfaces	1 UART 1 USB 1 SPI (optional) 1 DDC (I ² C compliant) 1 SQI interface (for flash update)
Digital I/O	Configurable timepulse 1 EXTINT input for Wakeup
Timepulse	Configurable 0.25 Hz to 10 MHz
Protocols	NMEA, UBX binary, RTCM

Support products

These u-blox M8 support tools are for getting familiar with u-blox M8 positioning technology, evaluating functionality, and visualizing GNSS performance.

EVK-M8U	u-blox M8 Untethered Dead Reckoning GNSS Evaluation Kit, supports NEO-M8U and EVA-M8E
C93-M8E	EVA-M8E application board, miniature EVA-M8E design example with integrated antenna

Product variants

EVA-M8E	u-blox M8 GNSS LCC SiP with Untethered Dead Reckoning, external flash and sensor
---------	--

NEO-M9N module

u-blox M9 standard precision GNSS module

Ultra-robust meter-level GNSS positioning module

- Maximum position availability with concurrent reception of 4 GNSS
- Advanced spoofing and jamming detection
- Excellent RF interference mitigation
- Pin-compatible with previous NEO products



Standard



Professional



Automotive



12.2 × 16.0 × 2.4 mm

Product description

The NEO-M9N module is built on the robust u-blox M9 GNSS chip, which provides exceptional sensitivity and acquisition times for all L1 GNSS systems. The u-blox M9 standard precision GNSS platform, which delivers meter-level accuracy, succeeds the well-known u-blox M8 product range.

NEO-M9N supports concurrent reception of four GNSS. The high number of visible satellites enables the receiver to select the best signals. This maximizes the position accuracy, in particular under challenging conditions such as in deep urban canyons.

NEO-M9N detects jamming and spoofing events and reports them to the host, so that the system can react to such events. Advanced filtering algorithms mitigate the impact of RF interference and jamming, thus enabling the product to operate as intended.

A SAW filter combined with an LNA in the RF path is integrated in the NEO-M9N module. This setup allows normal operation even under strong RF interferences, for example when a cellular modem is co-located with NEO-M9N.

NEO-M9N offers backwards pin-to-pin compatibility with previous u-blox generations, which saves designers time and cost when upgrading their design. Software migration requires little effort thanks to the continuous support of UBX messages across product generations.

NEO-M9N

Grade	
Automotive	
Professional	•
Standard	
GNSS	
GPS + QZSS/SBAS	•
GLONASS	•
Galileo	•
BeiDou	•
Number of concurrent GNSS	4
Interfaces	
UART	1
USB	1
SPI	1
DDC (I2C compliant)	1
Features	
Firmware upgrade	•
Data logging	•
RTC crystal	•
Oscillator	T
Antenna supply & supervisor	
Timepulse	1
Power supply	
2.7 V – 3.6 V	•

T = TCXO



Product performance

Receiver type	92-channel u-blox M9 engine GPS L1 C/A, QZSS L1 C/A/S, GLONASS L10F BeiDou B1I, Galileo E1B/C SBAS L1 C/A: WAAS, EGNOS, MSAS, GAGAN	
Nav. update rate	Up to 25 Hz (4 concurrent GNSS)	
Horizontal position accuracy	1.5 m CEP	
Acquisition ¹	Cold start	24 s
	Aided start	2 s
	Hot start	2 s
Sensitivity ¹	Tracking & Nav.	-167 dBm
	Reacquisition	-160 dBm
	Cold start	-148 dBm
	Hot start	-159 dBm

Tracking features

Power save modes	On/off, cyclic
Data batching	Autonomous tracking up to 10 min
Data-logger	Position, velocity, time, and odometer data
Geo-fencing	Up to 4 circular areas; GPIO for waking up the host CPU

Security features

Signal integrity	RF interference & jamming detection and reporting Active GNSS in-band filtering Spoofing detection and reporting
Device integrity	Secure boot of firmware downloaded from host or flash Receiver configuration lock by command
Secure interface	Signed UBX messages (SHA-256) JTAG debug interface disabled by default

Electrical data

Power supply	2.7 V to 3.6 V
Power	36 mA @ 3.0 V (4 GNSS continuous)
Consumption ¹	31 mA @ 3.0 V (2 GNSS continuous) 27 mA @ 3.0 V (1 GNSS continuous)
Backup Supply	2.7 V to 3.6 V

Package

24 pin LCC (Leadless Chip Carrier): 12.2 x 16.0 x 2.4 mm, 1.6 g

Environmental data, quality & reliability

Operating temp.	-40 °C to +85 °C
Storage temp.	-40 °C to +85 °C
Environmental grade	2015/863/EU RoHS-3
EMC	2014/53/EU RED
Environmental testing	ISO 16750
Quality management	Manufactured and fully tested in IATF 16949 certified production sites

Interfaces

Serial interfaces	1 UART 1 USB (NEO-M9N) 1 SPI (optional) 1 DDC (I2C compliant)
Digital I/O	Configurable timepulse 1 EXTINT input for Wakeup
Raw Data output	Code phase data
Timepulse	Configurable: 0.25 Hz to 10 MHz
Supported antennas	Active and passive
Protocols	NMEA 4.10, UBX binary, RTCM 3.3

Services

Assistance GNSS	AssistNow Online AssistNow Offline (up to 35 days) AssistNow Autonomous (up to 6 days) OMA SUPL & 3GPP compliant
-----------------	---

Support products

XPLR-M9	u-blox M9 GNSS Explorer Kit with easy-to-use software for first product evaluation
EVK-M91	u-blox M9 GNSS Evaluation Kit with UBX-M9140 chip and I/O interface

Product variants

NEO-M9N	u-blox M9 concurrent GNSS LCC module, firmware in RAM, upgradeable firmware, USB interface, flash memory, SAW filter, LNA
---------	---



ZOE-M8B SiP

Ultra small, super low power u-blox M8 GNSS SiP



Ultra small, ultra low power GNSS SiP with Super-E mode

- Ultra small size SiP (System-in-Package) 4.5 x 4.5 x 1.0 mm
- Fully integrated and complete solution, reducing total design efforts
- As low as 12 mW power consumption thanks to Super-E mode
- Ideal for passive antenna, due to built-in SAW and LNA
- High accuracy thanks to concurrent reception of up to 3 GNSS
- Pin-to-pin compatible with ZOE-M8G

4.5 x 4.5 x 1.0 mm

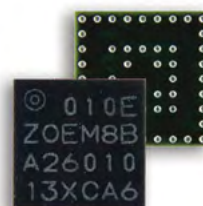

Product description

ZOE-M8B is u-blox's ultra small, highly integrated GNSS SiP (System in Package), measuring just 4.5 x 4.5 x 1.0 mm.

Making use of the Super-Efficient (Super-E) mode, ZOE-M8B offers an ideal balance between miniature size, low power consumption and good GNSS performance. ZOE-M8B uses up to 2.5 times less power than its pin-to-pin compatible counterpart, ZOE-M8G (running in 1 Hz full power mode), while still maintaining good positioning and speed accuracy. An average power consumption over a typical 30-minute track will be as low as 25 mW. This is true even when using an industrial antenna design with moderate-to-low signal levels. Super-E has a default performance setting for the best balance between power vs. performance. It also has a power save setting for additional power savings with potential compromise on performance.

The TCXO-based ZOE-M8B integrates a front-end SAW filter and an additional front-end LNA for increased jamming immunity and easier antenna integration. A passive antenna can be used to provide a highly integrated system solution with minimal eBOM.

Incorporating ZOE-M8B into customer designs is simple and straightforward thanks to the fully integrated design, single 1.8 V voltage supply, simple interface, and sophisticated interference suppression, which ensures maximum performance even in GNSS-hostile environments. In addition, the ZOE-M8B provides an SQI interface for optional external flash, continuous data logging, and improved A-GNSS performance.

ZOE-M8B is based on the high performance u-blox M8 concurrent GNSS engine, which supports GPS / GLONASS / BeiDou / GalileoC, including message integrity protection, anti-jamming, and anti-spoofing. All of these features together provide reliable positioning in difficult environmental conditions, as well as in security attack scenarios.

The ZOE-M8B SiP can be easily integrated in manufacturing thanks to the advanced S-LGA (Soldered Land Grid Array) packaging technology, which enables easier and more reliable soldering processes compared to a normal LGA (Land Grid Array) package. It is fully tested and qualified according to the JESD47 / ISO 16750 standard.

ZOE-M8B

	ZOE-M8B
Grade	
Automotive	
Professional	•
Standard	
GNSS	
GPS / QZSS	•
GLONASS	•
Galileo	cm
BeiDou	•
Number of concurrent GNSS	3
Interfaces	
UART	1
USB	
SPI	1
DDC (I ² C compliant)	1
Features	
Data logging	E
Data batching	•
Additional SAW	•
Additional LNA	•
RTC crystal	o
Oscillator	T
Power supply	
1.71 V – 1.89 V	•

E = External Flash Required
T = TCXO

cm = only supported in continuous mode
o = Optional, or requires external components



Features

Receiver type	72-channel u-blox M8 engine GPS/QZSS L1 C/A, GLONASS L10F BeiDou B1I, Galileo E1B/C ¹ SBAS L1 C/A: WAAS, EGNOS, MSAS, GAGAN	
	Super-E mode (default)	Continuous mode
Max nav. update rate		
Single GNSS	up to 4 Hz	up to 18 Hz
2 Concurrent GNSS	up to 4 Hz	up to 10 Hz
Accuracy	3.5 m CEP	2.5 m CEP
Sensitivity		
Tracking & Nav:	-160 dBm ²	-167 dBm
Cold starts:	-148 dBm	-148 dBm
Hot starts:	-157 dBm	-157 dBm
Acquisition	Cold starts: 26 s	Aided starts: 2 s
	Reacquisition: 1 s	
Assistance GNSS	AssistNow Online AssistNow Offline (up to 35 days) AssistNow Autonomous (GPS only, up to 6 days) OMA SUPL & 3GPP compliant	
Oscillator	TCXO	
RTC crystal	Can be derived from external RTC clock	
Super-E mode	Super Efficient mode for lowest power	
Anti jamming	Active CW detection and removal. Extra onboard SAW band pass filter	
Memory	ROM	
Supported antennas	Active and passive	
Raw Data	Code phase output	
Odometer	Integrated in navigation filter	
Geofencing	Up to 4 circular areas GPIO for waking up external CPU	
Spoofing detection	Built-in	
Signal integrity	Signature feature with SHA 256	
Data logging ³ and data batching	For position, velocity, time, and odometer data	

- 1 = Galileo only supported in continuous mode
2 = Switch to continuous mode with very weak signals
3 = External flash required

Interfaces

Serial interfaces	1 UART 1 SPI (optional) 1 DDC (I ² C compliant) 1 SQI interface (for optional flash)
Digital I/O	1 EXTINT input
Protocols	NMEA, UBX binary, RTCM

Package

51 pin S-LGA (Soldered Land Grid Array): 4.5 x 4.5 x 1.0 mm, 0.04 g

Environmental data, quality & reliability

Operating temp.	-40 °C to +85 °C
RoHS compliant (lead-free)	
Qualification according to standard	JESD47 / ISO 16750
Moisture sensitivity level	3

Electrical data

Supply voltage	1.71 V to 1.89 V
Power consumption ⁴	40 mA @ 1.8 V (Continuous mode, 1 Hz) 8.3 mA @ 1.8 V (Super-E mode, performance setting, 1 Hz) 6.8 mA @ 1.8 V (Super-E mode, power save setting, 1 Hz)
Backup Supply	1.4 V to 3.6 V

4 = Tracking, 2 concurrent GNSS

Support products

u-blox M8 Evaluation Kits:

Easy-to-use kits to get familiar with u-blox M8 positioning technology, evaluate functionality, and visualize GNSS performance.

EVK-M8BZOE u-blox M8 Low Power GNSS Evaluation Kit, supports ZOE-M8B

Product variants

ZOE-M8B u-blox M8 low power GNSS SiP, S-LGA, TCXO, ROM, SAW, LNA



ZOE-M8 series

Ultra small u-blox M8 GNSS SiPs

Ultra small GNSS SiPs with superior performance

- Ultra small size SiP (System-in-Package) 4.5 x 4.5 x 1.0 mm
- Fully integrated and complete solution, reducing total design efforts
- Ideal for passive antennas, due to built-in SAW and LNA
- High accuracy thanks to concurrent reception of up to 3 GNSS
- -167 dBm sensitivity for reliable positioning in challenging conditions



4.5 x 4.5 x 1.0 mm

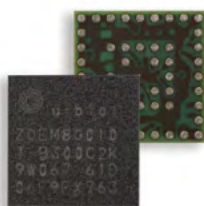

Product description

ZOE-M8G and ZOE-M8Q are u-blox's latest, highly integrated System in Package (SiP) GNSS solutions based on the high performing u-blox M8 concurrent positioning engine. The new, record breaking ultra miniature form factor integrates a complete GNSS SiP, including SAW filter, LNA and TCXO.

ZOE-M8 SiPs are targeted for applications that require a small size without compromising performance. For RF optimization, the ZOE-M8 SiPs integrate a front-end SAW filter and an additional front-end LNA for increased jamming immunity and easier antenna integration. A passive antenna can be used to provide a highly integrated system solution with minimal eBOM. Incorporating ZOE-M8 into customer designs is simple and straightforward thanks to the fully integrated design, single voltage supply (ZOE-M8G 1.8 V, ZOE-M8Q 3 V), low power consumption, simple interface, and sophisticated interference suppression that ensure maximum performance even in GNSS-hostile environments.

With its dual-frequency RF front-end, the ZOE-M8 SiPs are able to utilize concurrent reception of up to 3 GNSS systems (GPS/Galileo together with either BeiDou or GLONASS). In addition, the ZOE-M8 SiPs provide an SPI interface for optional external flash, allowing future firmware upgrades and improved A-GNSS performance.

Thanks to u-blox advanced algorithms and a complete GNSS solution, ZOE-M8 SiPs meet even the most stringent requirements in versatile industrial and consumer applications, such as UAVs, vehicles and assets tracking. The ZOE-M8 series also supports message integrity protection, anti-jamming, and anti-spoofing, providing reliable positioning in difficult environmental conditions as well as in security attack scenarios.

The ZOE-M8 S-LGA (Soldered Land Grid Array) packaging technology is easily integrated in manufacturing, which enables easier and more reliable soldering processes compared to a standard LGA package.

The ZOE-M8 SiPs are fully tested and qualified according to the JESD47 / ISO 16750 standard.

	ZOE-M8G	ZOE-M8Q
Grade		
Automotive		
Professional	•	•
Standard		
GNSS		
GPS / QZSS	•	•
GLONASS	•	•
Galileo	•	•
BeiDou	•	•
Number of concurrent GNSS	3	3
Interfaces		
UART	1	1
USB		
SPI	1	1
DDC (I ² C compliant)	1	1
Features		
Programmable (Flash)	E	E
Data logging	E	E
Additional SAW	•	•
Additional LNA	•	•
RTC crystal	o	o
Oscillator	T	T
Timepulse	1	1
Power supply		
1.71 V – 1.89 V	•	
2.7 V – 3.6 V		•

E = External Flash Required
C = Crystal / T = TCXO

o = Optional, or requires external components



Features

Receiver type	72-channel u-blox M8 engine GPS/QZSS L1 C/A, GLONASS L10F BeiDou B1I, Galileo E1B/C SBAS L1 C/A: WAAS, EGNOS, MSAS, GAGAN
Max navigation update rate ¹	Single GNSS: up to 18 Hz 2 Concurrent GNSS: up to 10 Hz
Accuracy ²	2.0 m CEP
Acquisition ²	Cold starts: 26 s Aided starts: 2 s Reacquisition: 1 s
Sensitivity ²	Tracking & Nav: -167 dBm Cold starts: -148 dBm Hot starts: -157 dBm
Assistance GNSS	AssistNow Online AssistNow Offline (up to 35 days) AssistNow Autonomous (up to 6 days) OMA SUPL & 3GPP compliant
Oscillator	TCXO
RTC crystal	Optional, can be connected to external RTC Clock
DC/DC converter	Optional only in ZOE-M8Q for low power, requires external components
Anti jamming	Active CW detection and removal. Extra onboard SAW band pass filter
Memory	ROM
SQL flash (optional) for	FW update AssistNow Offline, AssistNow Autonomous Data logging
Supported antennas	Active and passive
Raw Data	Code phase output
Odometer	Integrated in navigation filter
Geofencing	Up to 4 circular areas GPIO for waking up external CPU
Spoofing detection	Built-in
Signal integrity	Signature feature with SHA 256
Data-logger ³	For position, velocity, time, and odometer data

Electrical data

Supply voltage	1.71 V to 1.89 V (ZOE-M8G) 2.7 V to 3.6 V (ZOE-M8Q)
Power consumption ²	ZOE-M8G: 40 mA @ 1.8 V (Continuous) ZOE-M8Q ⁴ : 25 mA @ 3.0 V (Continuous)
Backup Supply	1.4 V to 3.6 V

- 1 ROM
- 1 Default mode: GPS/SBAS/QZSS+GLONASS
- 1 External flash required
- 1 with DC/DC

Package

51 pin S-LGA (Soldered Land Grid Array): 4.5 x 4.5 x 1.0 mm, 0.04 g

Environmental data, quality & reliability

Operating temp.	-40 °C to +85 °C
RoHS compliant (lead-free)	
Qualification according to standard	JESD47 / ISO 16750
Uses u-blox M8 chips qualified according to	AEC-Q100
Moisture sensitivity level	3

Interfaces

Serial interfaces	1 UART 1 SPI (optional) 1 DDC (I ² C compliant) 1 SQL interface (for optional flash)
Digital I/O	Configurable timepulse 1 EXTINT input
Timepulse	Configurable 0.25 Hz to 10 MHz
Protocols	NMEA, UBX binary, RTCM

Support products

u-blox M8 Evaluation Kits:

Easy-to-use kits to get familiar with u-blox M8 positioning technology, evaluate functionality, and visualize GNSS performance.

EVK-M8GZOE	u-blox M8 Concurrent GNSS Evaluation Kit, supports ZOE-M8G and ZOE-M8Q
------------	--

Product variants

ZOE-M8G	u-blox M8 concurrent GNSS SiP, 1.8 V, S-LGA, TCXO, ROM, SAW, LNA
ZOE-M8Q	u-blox M8 concurrent GNSS SiP, 3.0 V, S-LGA, TCXO, ROM, SAW, LNA



EVA-M8 series

Cost-efficient u-blox M8 GNSS SiP modules

Cost-efficient GNSS solution

- GNSS solution in 7x7 mm package
- Cost-efficient SiPs for different performance needs
- Highest accuracy thanks to 3 concurrent GNSS
- Highly integrated SiPs allow faster time-to-market
- Versatile products fit into wide range of applications



7.0 × 7.0 × 1.1 mm



Product description

The EVA-M8M and EVA-M8Q GNSS SiPs feature the superior performance of the u-blox M8 concurrent positioning engine, supporting GPS, Galileo, GLONASS and BeiDou. The EVA-M8 series delivers high sensitivity in the ultra compact EVA form factor of 7.0 × 7.0 × 1.1 mm.

The EVA-M8 series is an ideal solution for cost and space-sensitive industrial and wearable applications. It is easy to design-in, only requiring an external GNSS antenna in most applications. The layout of the EVA-M8 SiPs is especially designed to simplify the customer's design and limit near-field interferences, as RF and digital domains are kept separate. The EVA-M8Q is ideal for designs with small antennas or covert installations, whereas the EVA-M8M is the preference when system costs matter most.

With a dual-frequency RF front-end, the EVA-M8 concurrent GNSS SiPs are able to intelligently use the highest number of visible satellites from three GNSS systems (GPS and Galileo together with GLONASS or BeiDou) for reliable positioning.

The EVA-M8 series SiPs provide a Serial Quad Interface (SQI) for optional external flash which can be used for future firmware upgrades and improved Assistance GNSS performance. The EVA-M8 series also supports message integrity protection, geofencing and spoofing detection. The migration from previous generations is easy, as the EVA-M8 series is pin-compatible with the EVA-8M and EVA-7M SiPs.

The EVA-M8 series combines a high level of integration capability with flexible connectivity options in a miniature package. It can be easily integrated in manufacturing, thanks to the QFN-like package. The SiPs are available in 500 pieces/reel, which is ideal for small production batches. The DDC (I²C compliant) interface provides connectivity and enables synergies with most u-blox cellular modules.

The EVA-M8M and EVA-M8Q SiPs are fully tested and qualified according to the JESD47 standard.

	EVA-M8M	EVA-M8Q
Grade		
Automotive		
Professional	•	•
Standard		
GNSS		
GPS / QZSS	•	•
GLONASS	•	•
Galileo	•	•
BeiDou	•	•
Number of concurrent GNSS	3	3
Interfaces		
UART	1	1
USB	1	1
SPI	1	1
DDC (I ² C compliant)	1	1
Features		
Programmable (Flash)	E	E
Data logging	E	E
RTC crystal	o	o
Oscillator	C	T
Timepulse	1	1
Power supply		
1.65 V – 3.6 V	•	
2.7 V – 3.6 V		•

o = Optional, or requires external components
E = External Flash Required

C = Crystal / T = TCXO



Features

Receiver type	72-channel u-blox M8 engine GPS/QZSS L1 C/A, GLONASS L10F BeiDou B1I, Galileo E1B/C ¹ SBAS L1 C/A: WAAS, EGNOS, MSAS, GAGAN	
Max nav. update rate	Single GNSS:	up to 18 Hz
	2 Concurrent GNSS:	up to 10 Hz
Accuracy	Position:	2.5 m CEP
	SBAS:	2.0 m CEP
Acquisition ¹	EVA-M8M	EVA-M8Q
Cold starts:	26 s	26 s
Aided starts:	3 s	2 s
Reacquisition:	1 s	1 s
Sensitivity ¹		
Tracking & Nav:	-164 dBm	-167 dBm
Cold starts:	-148 dBm	-148 dBm
Hot starts:	-157 dBm	-157 dBm
Assistance GNSS	AssistNow Online AssistNow Offline (up to 35 days) AssistNow Autonomous (up to 6 days) OMA SUPL & 3GPP compliant	
Oscillator	Crystal (EVA-M8M) TCXO (EVA-M8Q)	
Real time clock (RTC)	Can be derived either from onboard GNSS crystal (EVA-M8M only, for lowest system costs and smallest size) or from external RTC Clock (EVA-M8M/Q, Default mode, for lower battery current)	
Anti jamming	Active CW detection and removal	
Memory	ROM	
SQI flash (optional) for	FW update AssistNow Offline, AssistNow Autonomous Data logging	
Supported antennas	Active and passive ²	
Antenna supervision	Short and open circuit detection supported with external circuit	
Raw Data	Code phase output	
Odometer	Integrated in navigation filter	
Geofencing	Up to 4 circular areas GPIO for waking up external CPU	
Spoofing detection	Built-in	
Signal integrity	Signature feature with SHA 256	
Data-logger ³	For position, velocity, time, and odometer data	

1 EVA-M8M-0/EVA-M8Q default mode: GPS/SBAS/QZSS+GLONASS

2 EVA-M8M: external LNA and SAW recommended for passive antenna applications

3 External flash required

Environmental data, quality & reliability

Operating temp.	-40 °C to +85 °C
RoHS compliant (lead-free) and green (no halogens)	
Qualification according to standard JESD47	
Moisture sensitivity level 3	

Package

43 pin LGA (Land Grid Array): 7.0 x 7.0 x 1.1 mm, 0.13 g

Electrical data

Supply voltage	1.65 V to 3.6 V (EVA-M8M) 2.7 V to 3.6 V (EVA-M8Q)
Digital I/O voltage level	1.65 V to 3.6 V (EVA-M8M) 2.7 V to 3.6 V (EVA-M8Q)
Power consumption ⁴	22 mA @ 3 V (Continuous) 5.3 mA @ 3 V Power Save mode (1 Hz)
Backup Supply	1.4 V to 3.6 V

4 EVA-M8M-0 default mode: GPS/SBAS/QZSS+GLONASS

Interfaces

Serial interfaces	1 UART 1 USB 1 SPI (optional) 1 DDC (I ² C compliant) 1 SQI interface (for flash update)
Digital I/O	Configurable timepulse 1 EXTINT input for Wakeup
Timepulse	Configurable 0.25 Hz to 10 MHz
Protocols	NMEA, UBX binary, RTCM

Support products

Evaluation kits to get familiar with u-blox M8 positioning technology, evaluate functionality, and visualize GNSS performance.

EVK-M8MEVA	u-blox M8 GNSS Evaluation Kit for EVA-M8M (crystal)
EVK-M8QEVA	u-blox M8 GNSS Evaluation Kit for EVA-M8Q (TCXO)
C88-M8M	NEO adaptor board using EVA-M8M for easy evaluation of existing NEO-xM designs

Product variants

EVA-M8M-0	u-blox M8 concurrent GNSS LGA SiP, crystal, ROM (Default: GPS + GLONASS)
EVA-M8M-1	u-blox M8 concurrent GNSS LGA SiP, crystal, ROM (Default: GPS + BeiDou)
EVA-M8Q-0	u-blox M8 concurrent GNSS LGA SiP, TCXO, ROM (Default: GPS + GLONASS)



EVA-8M SiP

Cost-efficient u-blox 8 GPS SiP

Cost-efficient GNSS solution

- Industry's smallest GPS/QZSS and GLONASS SiP
- High sensitivity of -164 dBm
- Cost-efficient system
- Minimal power consumption
- Superior anti-spoofing and anti-jamming
- Pin-compatible to EVA-7M



7.0 × 7.0 × 1.1 mm

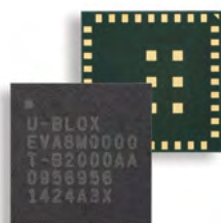

Product description

The EVA-8M standard precision GNSS SiP features the reliable performance of the u-blox 8 positioning engine (receiving GPS, GLONASS, QZSS and SBAS signals). The EVA-8M delivers high sensitivity in the ultra compact EVA form factor.

The EVA-8M supports advanced Power Save Modes and provides message integrity protection, geofencing, spoofing detection, and odometer functionalities.

The EVA-8M is an ideal solution for cost and space-sensitive applications. It is easy to design-in, only requiring an external GNSS antenna in most applications. The layout of the EVA-8M is especially designed to ease the customer's design and limit near field interferences, since RF and digital domains are kept separated.

The EVA-8M uses a crystal oscillator for lower system costs. Like other u-blox GNSS modules, the EVA-8M uses components selected for functioning reliably in the field over the full operating temperature range.

The EVA-8M is easily integrated in manufacturing, thanks to its QFN-like package and low moisture sensitivity level. The SiPs are available in 500 pieces/reel, ideal for small production batches.

The EVA-8M SiP combines a high level of integration capability with flexible connectivity options in a miniature package. This makes it perfectly suited for industrial and mass-market end products with strict size and cost requirements. The DDC (I²C compliant) interface provides connectivity and enables synergies with most u-blox cellular modules.

The EVA-8M SiP is manufactured in ISO/TS 16949 certified sites and qualified as stipulated in the JESD47 standard.

By offering backward compatibility to EVA-7M, migration to EVA-8M is easy.

	EVA-8M
Grade	
Automotive	
Professional	•
Standard	
GNSS	
GPS / QZSS	•
GLONASS	•
Galileo	
BeiDou	
Number of concurrent GNSS	1
Interfaces	
UART	1
USB	1
SPI	1
DDC (I ² C compliant)	1
Features	
Data logging	E
RTC crystal	o
Oscillator	C
Timepulse	1
Power supply	
1.65 V – 3.6 V	•

o = Optional, or requires external components
E = External Flash Required

C = Crystal



Features

Receiver type	72-channel u-blox 8 GNSS engine GPS/QZSS L1 C/A, GLONASS L1 FDMA, SBAS: WAAS, EGNOS, MSAS	
Nav. update rate	up to 18 Hz	
Position accuracy	GPS	GLONASS
Autonomous:	2.5 m CEP	4.0 m CEP
Acquisition		
Cold starts:	30 s	33 s
Aided starts:	3 s	3 s
Reacquisition:	1 s	1 s
Sensitivity		
Tracking & Nav:	-164 dBm	-163 dBm
Cold starts:	-147 dBm	-145 dBm
Hot starts:	-156 dBm	-155 dBm
Assistance GNSS	AssistNow Online AssistNow Offline (up to 35 days) AssistNow Autonomous (GPS only, up to 3 days) OMA SUPL & 3GPP compliant	
Oscillator	Crystal	
Real time clock (RTC)	Can be derived either from onboard GNSS crystal (for lowest system costs and smallest size) or from external RTC Clock (Default mode, for lower battery current)	
Anti jamming	Active CW detection and removal	
Memory	Onboard ROM	
SQI Flash (optional) for	AssistNow Offline AssistNow Autonomous Data logging	
Supported antennas	Active and passive ¹	
Antenna supervision	Short and open circuit detection supported with external circuit	
Raw Data	Code phase output	
Odometer	Integrated in navigation filter	
Geofencing	Up to 4 circular areas GPIO for waking up external CPU	
Spoofing detection	Built-in	
Signal integrity	Signature feature with SHA 256	
Data-logger ²	For position, velocity, time, and odometer data	

¹ External LNA and SAW recommended for passive antenna applications

² External Flash required

Environmental data, quality & reliability

Operating temp.	-40 °C to +85 °C
Storage temp.	-40 °C to +105 °C
RoHS compliant (lead-free) and green (no halogens)	
Qualification according to standard	JESD47
Manufactured in ISO/TS 16949 certified production sites	
Moisture sensitivity level	3

Package

43 pin LGA (Land Grid Array): 7.0 x 7.0 x 1.1 mm, 0.13 g

Electrical data

Supply voltage	1.65 V to 3.6 V
Digital I/O voltage level	1.65 V to 3.6 V
Power consumption ³	16 mA @ 3 V (Continuous) 3.7 mA @ 3 V Power Save mode (1 Hz)
Backup Supply	1.4 V to 3.6 V

³ For default mode: GPS incl. QZSS, SBAS

Interfaces

Serial interfaces	1 UART 1 USB 1 SPI (optional) 1 DDC (I ² C compliant) 1 SQI interface (For optional external Flash)
Digital I/O	Configurable timepulse 1 EXTINT input for Wakeup
Timepulse	Configurable 0.25 Hz to 10 MHz
Protocols	NMEA, UBX binary, RTCM

Support products

Evaluation kits to get familiar with u-blox 8 positioning technology, evaluate functionality, and visualize GNSS performance.

EVK-M8MEVA Evaluation Kit for EVA-8M (crystal), in single GNSS mode (GPS or GLONASS)

Product variants

EVA-8M u-blox 8 GNSS LGA SiP, Crystal, ROM



MAX-M8 series

Small u-blox M8 GNSS modules

Small GNSS modules for easy manufacturing

- Concurrent reception of up to 3 GNSS (GPS, Galileo, GLONASS, BeiDou)
- Industry leading –167 dBm navigation sensitivity
- Product variants to meet performance and cost requirements
- Miniature LCC package
- Superior anti-spoofing and anti-jamming
- Pin-compatible with MAX-7 and MAX-6



Product description

The MAX-M8 series of concurrent GNSS modules is built on the exceptional performance of the u-blox M8 engine in the industry proven MAX form factor.

The MAX-M8 modules utilize concurrent reception of up to three GNSS systems (GPS/Galileo together with either BeiDou or GLONASS) for more reliable positioning. The MAX-M8 series provides high sensitivity and minimal acquisition times while maintaining low system power. It also supports message integrity protection, geofencing, and spoofing detection.

The MAX-M8C is optimized for cost-sensitive applications and has the lowest power consumption, the MAX-M8Q provides best performance for passive and active antennas designs, while the MAX-M8W is optimized for active antennas with an integrated antenna supply and supervisor to detect an open or short circuit on the antenna line. The industry-proven MAX form factor allows easy migration from previous MAX generations.

The MAX-M8 series combines a high level of integration capability with flexible connectivity options in a miniature package. This makes MAX-M8 perfectly suited for industrial applications with strict size and cost requirements. The MAX-M8Q is also halogen free (green) which makes it a perfect solution for consumer applications. The DDC (I²C compliant) interface provides connectivity and enables synergies with most u-blox cellular modules.

u-blox M8 modules use GNSS chips qualified according to AEC-Q100, are manufactured in ISO/TS 16949 certified sites, and fully tested on a system level. Qualification tests are performed as stipulated in the ISO16750 standard: “Road vehicles – Environmental conditions and testing for electrical and electronic equipment”.

	MAX-M8C	MAX-M8Q	MAX-M8W
Grade			
Automotive			
Professional	•	•	•
Standard			
GNSS			
GPS / QZSS	•	•	•
GLONASS	•	•	•
Galileo	•	•	•
BeiDou	•	•	•
Number of concurrent GNSS	3	3	3
Interfaces			
UART	1	1	1
USB			
SPI			
DDC (I ² C compliant)	1	1	1
Features			
Oscillator	C	T	T
RTC crystal	♦	•	•
Built-in antenna supply and supervisor			•
Timepulse	1	1	1
Power supply			
1.65 V – 3.6 V	•		
2.7 V – 3.6 V		•	•

♦ = Yes, but with higher backup current

C = Crystal / T = TCXO



Features

Receiver type	72-channel u-blox M8 engine GPS/QZSS L1 C/A, GLONASS L10F BeiDou B1I, Galileo E1B/C SBAS L1 C/A: WAAS, EGNOS, MSAS, GAGAN		
Nav. update rate	Single GNSS: up to 18 Hz 2 Concurrent GNSS: up to 10 Hz		
Positioning accuracy	Autonomous 2.5 m CEP		
		MAX-M8Q/W	MAX-M8C
Acquisition ¹	Cold starts:	26 s	26 s
	Aided starts:	2 s	3 s
	Reacquisition:	1 s	1 s
Sensitivity ¹	Tracking:	-167 dBm	-164 dBm
	Cold starts:	-148 dBm	-148 dBm
	Hot starts:	-157 dBm	-157 dBm
Assistance GNSS	AssistNow Online AssistNow Offline (up to 35 days) AssistNow Autonomous (GPS only, up to 3 days) OMA SUPL & 3GPP compliant		
Oscillator	TCXO (MAX-M8Q/M8W) Crystal (MAX-M8C)		
RTC crystal	Built-in (MAX-M8Q/M8W) Cost efficient solution with higher backup current (MAX-M8C)		
Anti jamming	Active CW detection and removal		
Memory	Onboard ROM		
Supported antennas	Active and passive		
Raw Data	Code phase output		
Odometer	Integrated in navigation filter		
Geofencing	Up to 4 circular areas GPIO for waking up external CPU		
Spoofing detection	Built-in		
Signal integrity	Signature feature with SHA 256		

¹ For default mode: GPS/SBAS/QZSS + GLONASS

Electrical data

Power supply	1.65 V to 3.6 V (MAX-M8C) 2.7 V to 3.6 V (MAX-M8Q/M8W)
Digital I/O voltage level	1.65 V to 3.6 V (MAX-M8C) 2.7 V to 3.6 V (MAX-M8Q/M8W)
Power Consumption ²	23 mA @ 3 V (Continuous) 5.4 mA @ 3 V Power Save mode (1 Hz)
Backup Supply	1.4 V to 3.6 V

² MAX-M8C, GPS/SBAS/QZSS + GLONASS (default mode)

Package

18 pin LCC (Leadless Chip Carrier): 9.7 x 10.1 x 2.5 mm, 0.6 g

Environmental data, quality & reliability

Operating temp.	-40 °C to +85 °C
Storage temp.	-40 °C to +85 °C (MAX-M8Q/M8W)
	-40 °C to +105 °C (MAX-M8C)

RoHS compliant (lead-free)

Green (halogen-free): MAX-M8Q

Qualification according to ISO 16750

Manufactured in ISO/TS 16949 certified production sites

Uses u-blox M8 chips qualified according to AEC-Q100

Interfaces

Serial interfaces	1 UART
	1 DDC (I ² C compliant)
Digital I/O	Configurable timepulse
	1 EXTINT input for Wakeup
Timepulse	Configurable: 0.25 Hz to 10 MHz
Protocols	NMEA, UBX binary, RTCM

Support products

u-blox M8 Evaluation Kits:

Easy-to-use kits to get familiar with u-blox M8 positioning technology, evaluate functionality, and visualize GNSS performance.

EVK-M8N	u-blox M8 GNSS Evaluation Kit, with TCXO, supports MAX-M8Q/M8W
EVK-M8C	u-blox M8 GNSS Evaluation Kit, with Crystal, supports MAX-M8C

Product variants

MAX-M8C	u-blox M8 GNSS LCC module, crystal, ROM
MAX-M8Q	u-blox M8 GNSS LCC module, TCXO, ROM
MAX-M8W	u-blox M8 concurrent GNSS LCC module, TCXO, active antenna supply, ROM



MAX-8 series

Small u-blox 8 GPS modules

Small GPS modules for easy manufacturing

- High sensitivity of -166 dBm for single GNSS reception
- Cost-efficient system
- TCXO-based variant for fastest time to first fix
- Low power consumption
- Superior anti-spoofing and anti-jamming
- Pin-compatible to MAX-7



Standard



Professional



Automotive

9.7 × 10.1 × 2.5 mm



Product description

The MAX-8 series of standard precision GNSS modules features the reliable performance of the u-blox 8 positioning engine, which receives GPS, GLONASS, QZSS and SBAS signals. The MAX-8 series delivers high sensitivity and minimal acquisition times in the ultra compact MAX form factor.

The economical MAX-8 series provides high sensitivity while featuring low power consumption and supporting advanced Power Save Modes. It also provides message integrity protection, geofencing, spoofing detection, and odometer functionalities.

The MAX-8C is optimized for cost sensitive applications with lowest power, while the MAX-8Q provides best performance. The industry proven MAX form factor allows easy migration from MAX-7 and MAX-6 modules by offering backward compatibility. Sophisticated RF-architecture and interference suppression ensure maximum performance even in GNSS-hostile environments. The MAX-8 series combines a high level of integration capability with flexible connectivity options in a miniature package. This makes it perfectly suited for industrial and mass-market end products with strict size and cost requirements. The DDC (I²C compliant) interface provides connectivity and enables synergies with most u-blox cellular modules.

u-blox 8 modules use GNSS chips qualified according to AEC-Q100 and are manufactured in ISO/TS 16949 certified sites. Qualification tests are performed as stipulated in the ISO16750 standard: "Road vehicles – Environmental conditions and testing for electrical and electronic equipment". MAX-8Q complies with green/halogen free standards.

	MAX-8C	MAX-8Q
Grade		
Automotive		
Professional	•	•
Standard		
GNSS		
GPS / QZSS	•	•
GLONASS	•	•
Galileo		
BeiDou		
Number of concurrent GNSS	1	1
Interfaces		
UART	1	1
USB		
SPI		
DDC (I ² C compliant)	1	1
Features		
Oscillator	C	T
RTC crystal	◆	•
Timepulse	1	1
Power supply		
1.65 V – 3.6 V	•	
2.7 V – 3.6 V		•

◆ = Yes, but with higher backup current

C = Crystal / T = TCXO



Features

Receiver type	72-channel u-blox 8 engine GPS/QZSS L1 C/A, GLONASS L1 FDMA, SBAS: WAAS, EGNOS, MSAS	
Nav. update rate	Up to 18 Hz	
Position accuracy	GPS	GLONASS
Autonomous	2.5 m CEP	4.0 m CEP
Acquisition ¹	29 s	30 s
Cold starts:	2 s	2 s
Aided starts:	1 s	1 s
Reacquisition:		
Sensitivity ¹		
Tracking:	-166 dBm	-166 dBm
Cold starts:	-148 dBm	-145 dBm
Hot starts:	-157 dBm	-156 dBm
Assistance GNSS	AssistNow Online AssistNow Offline (up to 35 days) AssistNow Autonomous (GPS only, up to 3 days) OMA SUPL & 3GPP compliant	
Oscillator	TCXO (MAX-8Q) Crystal (MAX-8C)	
RTC crystal	Built-in (MAX-8Q) Cost efficient solution with higher Backup current (MAX-8C)	
Anti jamming	Active CW detection and removal	
Memory	Onboard ROM	
Supported antennas	Active and passive	
Raw data	Code phase output	
Odometer	Integrated in navigation filter	
Geofencing	Up to 4 circular areas GPIO for waking up external CPU	
Spoofing detection	Built-in	
Signal integrity	Signature feature with SHA 256	

¹ MAX-8Q

Electrical data

Power supply	1.65 V to 3.6 V (MAX-8C) 2.7 V to 3.6 V (MAX-8Q)	
Digital I/O voltage level	1.65 V to 3.6 V (MAX-8C) 2.7 V to 3.6 V (MAX-8Q)	
Power Consumption ²	16 mA @ 3 V (Continuous) 3.8 mA @ 3 V Power Save mode (1 Hz)	
Backup Supply	1.4 V to 3.6 V	

² MAX-8C, default mode: GPS incl. QZSS, SBAS

Package

18 pin LCC (Leadless Chip Carrier): 9.7 x 10.1 x 2.5 mm, 0.6 g

Environmental data, quality & reliability

Operating temp.	-40 °C to +85 °C
Storage temp.	-40 °C to +85 °C
RoHS compliant (lead-free)	
Green (halogen-free):	MAX-8Q
Qualification according to ISO 16750	
Manufactured in ISO/TS 16949 certified production sites	
Uses u-blox 8 chips qualified according to AEC-Q100	

Interfaces

Serial interfaces	1 UART 1 DDC (I ² C compliant)
Digital I/O	Configurable timepulse 1 EXTINT input for Wakeup
Timepulse	Configurable: 0.25 Hz to 10 MHz
Protocols	NMEA, UBX binary, RTCM

Support products

u-blox 8 Evaluation Kits:

Easy-to-use kits to get familiar with u-blox 8 positioning technology, evaluate functionality, and visualize GNSS performance.

EVK-8N	u-blox 8 GNSS Evaluation Kit, with TCXO, supports MAX-8Q
EVK-M8C	u-blox M8 GNSS Evaluation Kit (in single GPS or single GLONASS mode), with Crystal, supports MAX-8C

Product variants

MAX-8C	u-blox 8 GNSS LCC module, crystal, ROM
MAX-8Q	u-blox 8 GNSS LCC module, TCXO, ROM

NEO-M8 series

Versatile u-blox M8 GNSS modules

Versatile GNSS modules in different variants for easy manufacturing

- Concurrent reception of up to 3 GNSS (GPS, Galileo, GLONASS, BeiDou)
- Industry leading -167 dBm navigation sensitivity
- Security and integrity protection
- Supports all satellite augmentation systems
- Advanced jamming and spoofing detection
- Product variants to meet performance and cost requirements
- Backward compatible with NEO-7 and NEO-6 families



Standard



Professional



Automotive

12.2 × 16.0 × 2.4 mm



Product description

The NEO-M8 series of concurrent GNSS modules is built on the high performing u-blox M8 GNSS engine in the industry proven NEO form factor.

The NEO-M8 modules utilize concurrent reception of up to three GNSS systems (GPS/Galileo together with BeiDou or GLONASS), recognize multiple constellations simultaneously and provide outstanding positioning accuracy in scenarios where urban canyon or weak signals are involved. For even better and faster positioning improvement, the NEO-M8 series supports augmentation of QZSS, GAGAN and IMES together with WAAS, EGNOS, and MSAS. The NEO-M8 series also supports message integrity protection, geofencing, and spoofing detection with configurable interface settings to easily fit to customer applications.

The NEO-M8M is optimized for cost sensitive applications, while NEO-M8N and NEO-M8Q provide best performance and easier RF integration. The NEO-M8N offers high performance also at low power consumption levels. The future-proof NEO-M8N includes an internal Flash that allows future firmware updates. This makes NEO-M8N perfectly suited to industrial and automotive applications.

The DDC (I²C compliant) interface provides connectivity and enables synergies with most u-blox cellular modules. For RF optimization, the NEO-M8N/Q features an additional front-end LNA for easier antenna integration and a front-end SAW filter for increased jamming immunity.

u-blox M8 modules use GNSS chips qualified according to AEC-Q100, are manufactured in ISO/TS 16949 certified sites, and are fully tested on a system level. Qualification tests are performed as stipulated in the ISO16750 standard: “Road vehicles – Environmental conditions and testing for electrical and electronic equipment”.

	NEO-M8M	NEO-M8N	NEO-M8Q
Grade			
Automotive			
Professional	•	•	•
Standard			
GNSS			
GPS / QZSS	•	•	•
GLONASS	•	•	•
Galileo	•	•	•
BeiDou	•	•	•
Number of concurrent GNSS	3	3	3
Interfaces			
UART	1	1	1
USB	1	1	1
SPI	1	1	1
DDC (I ² C compliant)	1	1	1
Features			
Programmable (Flash)		•	
Data logging		•	
Additional SAW		•	•
Additional LNA		•	•
RTC crystal	•	•	•
Oscillator	C	T	T
Timepulse	1	1	1
Power supply			
1.65 V – 3.6 V	•		
2.7 V – 3.6 V		•	•

T = TCXO C = Crystal



Features

Receiver type	72-channel u-blox M8 engine GPS/QZSS L1 C/A, GLONASS L10F BeiDou B1I, Galileo E1B/C SBAS L1 C/A: WAAS, EGNOS, MSAS, GAGAN	
Nav. update rate ¹	Single GNSS:	up to 18 Hz
	2 Concurrent GNSS:	up to 10 Hz
Position accuracy	2.0 m CEP	
Acquisition ²	NEO-M8N/Q	NEO-M8M
Cold starts:	26 s	26 s
Aided starts:	2 s	3 s
Reacquisition:	1 s	1 s
Sensitivity ²		
Tracking & Nav.:	-167 dBm	-164 dBm
Cold starts:	-148 dBm	-148 dBm
Hot starts:	-157 dBm	-157 dBm
Assistance GNSS	AssistNow Online AssistNow Offline (up to 35 days) AssistNow Autonomous (up to 6 days) OMA SUPL & 3GPP compliant	
Oscillator	TCXO (NEO-M8N/Q) Crystal (NEO-M8M)	
RTC crystal	Built-In	
Anti jamming	Active CW detection and removal. Extra on-board SAW band pass filter (NEO-M8N/Q)	
Memory	ROM (NEO-M8M/Q) or Flash (NEO-M8N)	
Supported antennas	Active and passive	
Raw data	Code phase output	
Odometer	Integrated in navigation filter	
Geofencing	Up to 4 circular areas GPIO for waking up external CPU	
Spoofing detection	Built-in	
Signal integrity	Signature feature with SHA 256	
Data-logger ³	For position, velocity, time, odometer data	

1 NEO-M8M/Q

2 For default mode: GPS/SBAS/QZSS+GLONASS

3 NEO-M8N

Electrical data

Power supply	1.65 V to 3.6 V (NEO-M8M) 2.7 V to 3.6 V (NEO-M8N/Q)
Power Consumption ⁴	21 mA @ 3.0 V (Continuous) 5.3 mA @ 3.0 V Power Save mode (1 Hz)
Backup Supply	1.4 V to 3.6 V

4 NEO-M8M in default mode: GPS/SBAS/QZSS+GLONASS

Package

24 pin LCC (Leadless Chip Carrier): 12.2 x 16.0 x 2.4 mm, 1.6 g

Environmental data, quality & reliability

Operating temp.	-40 °C to +85 °C
Storage temp.	-40 °C to +85 °C (NEO-M8N/Q) -40 °C to +105 °C (NEO-M8M)

RoHS compliant (lead-free)

Qualification according to ISO 16750

Manufactured and fully tested in ISO/TS 16949 certified production sites

Uses u-blox M8 chips qualified according to AEC-Q100

Interfaces

Serial interfaces	1 UART 1 USB V2.0 full speed 12 Mbit/s 1 SPI (optional) 1 DDC (I ² C compliant)
Digital I/O	Configurable timepulse 1 EXTINT input for Wakeup
Timepulse	Configurable: 0.25 Hz to 10 MHz
Protocols	NMEA, UBX binary, RTCM

Support products

u-blox M8 Evaluation Kits:

Easy-to-use kits to get familiar with u-blox M8 positioning technology, evaluate functionality, and visualize GNSS performance.

EVK-M8N	u-blox M8 GNSS Evaluation Kit, with TCXO, supports NEO-M8N/Q
EVK-M8C	u-blox M8 GNSS Evaluation Kit, with crystal, supports NEO-M8M

Product variants

NEO-M8M	u-blox M8 concurrent GNSS LCC module, crystal, ROM
NEO-M8N	u-blox M8 concurrent GNSS LCC module, TCXO, Flash, SAW, LNA
NEO-M8Q	u-blox M8 concurrent GNSS LCC module, TCXO, ROM, SAW, LNA



NEO-M8Q-01A module

Automotive grade u-blox M8 GNSS module

Automotive grade GNSS module with operational range $-40\text{ }^{\circ}\text{C}$ to $+105\text{ }^{\circ}\text{C}$

- Highest accuracy thanks to concurrent reception of 3 GNSS
- Superior security and integrity protection
- Industry leading -167 dBm navigation sensitivity
- Zero PPM program



12.2 × 16.0 × 2.4 mm



Product description

The NEO-M8Q-01A is a ROM-based Automotive Grade concurrent GNSS module, targeted for use in hazardous environments such as automotive applications.

The module is built on the exceptional performance of the u-blox M8 GNSS engine in the industry proven NEO form factor. It utilizes concurrent reception of up to three GNSS systems (GPS/Galileo together with either BeiDou or GLONASS) for more reliable positioning.

The NEO-M8Q-01A provides high sensitivity and minimal acquisition times while maintaining low system power. The automotive grade module is optimized for applications where an extended operational temperature range ($-40\text{ }^{\circ}\text{C}$ to $+105\text{ }^{\circ}\text{C}$) is required. The sophisticated RF architecture and interference suppression ensure maximum performance even in GNSS-hostile environments.

The NEO-M8Q-01A combines a high level of robustness and integration capability along with flexible connectivity options via USB, I²C, UART and SPI. The DDC (I²C compliant) interface provides connectivity and enables synergies with most u-blox cellular modules.

With sophisticated message signature capabilities and spoofing detection, the NEO-M8Q-01A automotive grade module offers high protection against malicious positioning interference.

The NEO-M8Q-01A uses GNSS chips qualified according to AEC-Q100. The modules are manufactured in ISO/TS 16949 certified sites and fully tested on a system level. Qualification tests are performed as stipulated in the ISO16750 standard: "Road vehicles – Environmental conditions and testing for electrical and electronic equipment".

The NEO-M8Q-01A automotive grade module adheres to automotive industry standard quality specifications and production flow.

NEO-M8Q-01A

Grade	
Automotive	•
Professional	
Standard	
GNSS	
GPS / QZSS	•
GLONASS	•
Galileo	•
BeiDou	•
Number of concurrent GNSS	3
Interfaces	
UART	1
USB	1
SPI	1
DDC (I ² C compliant)	1
Features	
RTC crystal	•
Oscillator	T
Timepulse	1
Power supply	
2.7 V – 3.6 V	•

T = TCXO



Features

Receiver type	72-channel u-blox M8 engine GPS/QZSS L1 C/A, GLONASS L10F BeiDou B1I, Galileo E1B/C SBAS L1 C/A: WAAS, EGNOS, MSAS, GAGAN
Nav. update rate	Single GNSS: up to 18 Hz Concurrent GNSS: up to 10 Hz
Position accuracy	2.0 m CEP
Acquisition ¹	
Cold starts:	26 s
Aided starts:	2 s
Reacquisition:	1 s
Sensitivity ¹	
Tracking & Nav.:	-167 dBm
Cold starts:	-148 dBm
Hot starts:	-157 dBm
Assistance GNSS	AssistNow Online AssistNow Offline (up to 35 days) AssistNow Autonomous (GPS only, up to 3 days) OMA SUPL & 3GPP compliant
Oscillator	TCXO
RTC crystal	Built-in
Noise figure	On-chip LNA
Anti jamming	Active CW detection and removal
Memory	ROM
Supported antennas	Active and passive ²
Raw Data	Code phase output
Odometer	Integrated in navigation filter
Geofencing	Up to 4 circular areas GPIO for waking up external CPU
Spoofing detection	Built-in
Signal integrity	Signature feature with SHA 256

1 For default mode: GPS/SBAS/QZSS+GLONASS

2 External LNA and SAW is recommended for passive antenna applications

Electrical data

Supply voltage	2.7 V to 3.6 V
Power	22 mA @ 3.0 V (continuous, concurrent)
Consumption ¹	6.3 mA @ 3.0 V Power Save mode (1 Hz)
Backup Supply	1.4 V to 3.6 V

Package

24 pin LCC (Leadless Chip Carrier): 12.2 x 16.0 x 2.4 mm, 1.6 g

Environmental data, quality & reliability

Operating temp.	-40 °C to +105 °C
RoHS compliant (lead-free)	
Qualification according to ISO 16750	
Manufactured and fully tested in ISO/TS 16949 certified production sites	
Uses u-blox M8 chips qualified according to AEC-Q100	

Interfaces

Serial interfaces	1 UART 1 USB V2.0 full speed 12 Mbit/s 1 SPI (optional) 1 DDC (I ² C compliant)
Digital I/O	Configurable timepulse 1 EXTINT input for Wakeup
Timepulse	Configurable: 0.25 Hz to 10 MHz
Protocols	NMEA, UBX binary, RTCM

Support products

u-blox M8 Evaluation Kits:

Easy-to-use kits to get familiar with u-blox M8 positioning technology, evaluate functionality, and visualize GNSS performance.

EVK-M8N³ u-blox M8 GNSS Evaluation Kit, supports NEO-M8Q-01A

³ The EVK supports a temperature range of -40 °C to +65 °C

Product variants

NEO-M8Q-01A u-blox M8 concurrent GNSS LCC module, TCXO, ROM, Automotive Grade



NEO-8Q module

u-blox 8 GPS module

Robust GPS module for easy manufacturing

- High sensitivity of -166 dBm for single GNSS reception
- Cost-efficient system
- TCXO-based product enables fastest time-to-first-fix
- Low power consumption
- Superior anti-spoofing and anti-jamming



12.2 × 16.0 × 2.4 mm



Product description

The NEO-8Q standard precision GNSS module is built on the reliable performance of the u-blox 8 GNSS engine, which receives GPS, GLONASS, QZSS and SBAS signals. The NEO-8Q delivers high sensitivity and minimal acquisition times in the industry proven NEO form factor.

The NEO-8Q features low power consumption and supports advanced Power Save Modes. It also provides message integrity protection, geofencing, spoofing detection, and odometer functionalities.

NEO-8Q is an economical choice for best performance and easier RF integration. For RF optimization the NEO-8Q features an additional front-end LNA for easier antenna integration and a front-end SAW filter for increased jamming immunity. The industry proven NEO form factor allows easy migration from previous NEO generations. Sophisticated RF architecture and interference suppression ensure maximum performance even in GNSS-hostile environments.

The NEO-8Q combines a high level of robustness and integration capability with flexible connectivity options. The DDC (I²C compliant) interface provides connectivity and enables synergies with most u-blox cellular modules.

u-blox 8 modules use GNSS chips qualified according to AEC-Q100 and are manufactured in ISO/TS 16949 certified sites. Qualification tests are performed as stipulated in the ISO16750 standard: “Road vehicles – Environmental conditions and testing for electrical and electronic equipment”.

NEO-8Q

	NEO-8Q
Grade	
Automotive	
Professional	•
Standard	
GNSS	
GPS / QZSS	•
GLONASS	•
Galileo	
BeiDou	
Number of concurrent GNSS	1
Interfaces	
UART	1
USB	1
SPI	1
DDC (I ² C compliant)	1
Features	
Additional SAW	•
Additional LNA	•
RTC crystal	•
Oscillator	T
Timepulse	1
Power supply	
2.7 V – 3.6 V	•

TT = TCXO



Features

Receiver type	72-channel u-blox 8 engine GPS L1 C/A, GLONASS L1 FDMA, QZSS L1 C/A SBAS: WAAS, EGNOS, MSAS	
Nav. update rate	up to 18 Hz	
Position accuracy	GPS	GLONASS
Autonomous:	2.5 m CEP	4.0 m CEP
Acquisition		
Cold starts:	29 s	30 s
Aided starts:	2 s	2 s
Reacquisition:	1 s	1 s
Sensitivity		
Tracking & Nav.:	-166 dBm	-166 dBm
Cold starts:	-148 dBm	-145 dBm
Hot starts:	-157 dBm	-156 dBm
Assistance GNSS	AssistNow Online AssistNow Offline (up to 35 days) AssistNow Autonomous (GPS only, up to 3 days) OMA SUPL & 3GPP compliant	
Oscillator	TCXO	
RTC crystal	Built-in	
Anti jamming	Active CW detection and removal; extra onboard SAW band pass filter	
Memory	ROM	
Supported antennas	Active and passive	
Raw Data	Code phase output	
Odometer	Integrated in navigation filter	
Geofencing	Up to 4 circular areas GPIO for waking up external CPU	
Spoofing detection	Built-in	
Signal integrity	Signature feature with SHA 256	

Electrical data

Supply voltage	2.7 V to 3.6 V
Power	22 mA @ 3.0 V (Continuous)
Consumption ¹	10 mA @ 3.0 V Power Save mode (1 Hz)
Backup Supply	1.4 V to 3.6 V

¹ For default mode: GPS incl. QZSS, SBAS

Package

24 pin LCC (Leadless Chip Carrier): 12.2 x 16.0 x 2.4 mm, 1.6 g

Environmental data, quality & reliability

Operating temp.	-40 °C to +85 °C
Storage temp.	-40 °C to +85 °C
RoHS compliant (lead-free)	
Qualification according to ISO 16750	
Manufactured in ISO/TS 16949 certified production sites	
Uses u-blox 8 chips qualified according to AEC-Q100	

Interfaces

Serial interfaces	1 UART 1 USB V2.0 full speed 12 Mbit/s 1 SPI (optional) 1 DDC (I ² C compliant)
Digital I/O	Configurable timepulse 1 EXTINT input for Wakeup
Timepulse	Configurable: 0.25 Hz to 10 MHz
Protocols	NMEA, UBX binary, RTCM

Support products

u-blox 8 Evaluation Kits:

Easy-to-use kits to get familiar with u-blox M8 positioning technology, evaluate functionality, and visualize GNSS performance.

EVK-8N	u-blox 8 GNSS Evaluation Kit, supports TCXO, supports NEO-8Q
--------	---

Product variants

NEO-8Q	u-blox 8 GNSS LCC module, TCXO, ROM, SAW, LNA
--------	--



LEA-M8S module

u-blox M8 GNSS module

Seamless upgrade of existing LEA-6 designs to multi-GNSS

- Concurrent reception of up to 3 GNSS (GPS, Galileo, GLONASS, BeiDou)
- Industry leading -167 dBm navigation sensitivity
- Combines low power consumption and high sensitivity
- Superior anti-spoofing and anti-jamming
- UART, USB and DDC (I²C compliant) interfaces
- Easy migration from LEA-6 modules



Product description

The LEA-M8S module delivers concurrent GNSS location capability together with high-performance u-blox M8 positioning technology in the industry proven LEA form factor.

With its dual-frequency RF front-end, the LEA-M8S concurrent GNSS module is able to intelligently use the highest number of visible satellites from up to three GNSS systems (GPS/Galileo together with either BeiDou or GLONASS) for more reliable positioning. The LEA-M8S provides exceptional performance with low system power, and is optimized for cost sensitive applications. It also supports message integrity protection, geofencing, and spoofing detection.

The LEA-M8S has sophisticated RF-architecture and interference suppression ensuring maximum performance even in GNSS-hostile environments. It features very low power GLONASS functionality. This 6th generation module in the LEA form factor allows simple migration from LEA-6x GPS and LEA-6N GPS/GLONASS modules.

The LEA-M8S combines a high level of robustness and integration capability with flexible connectivity options. The DDC (I²C compliant) interface provides connectivity and enables synergies with most u-blox cellular modules. For RF optimization, the LEA-M8S features a front-end SAW filter for increased jamming immunity.

LEA-M8S module uses u-blox GNSS chips qualified according to AEC-Q100 and is manufactured in ISO/TS 16949 certified sites. Qualification tests are performed as stipulated in the ISO16750 standard: "Road vehicles – Environmental conditions and testing for electrical and electronic equipment".

LEA-M8S

Grade	
Automotive	
Professional	•
Standard	
GNSS	
GPS / QZSS	•
GLONASS	•
Galileo	•
BeiDou	•
Number of concurrent GNSS	3
Interfaces	
UART	1
USB	1
SPI	
DDC (I ² C compliant)	1
Features	
Additional SAW	•
RTC crystal	•
Oscillator	T
Built-in antenna supply & supervisor	•
Timepulse	1
Power supply	
2.7 V – 3.6 V	•

T = TCXO



Features

Receiver type	72-channel u-blox concurrent M8 engine GPS/QZSS L1 C/A, GLONASS L10F, BeiDou B1 I, Galileo E1B/C SBAS L1 C/A: WAAS, EGNOS, MSAS, GAGAN	
Nav. update rate	Single GNSS:	up to 18 Hz
	2 Concurrent GNSS:	up to 10 Hz
Accuracy	Position	2.5 m CEP
	SBAS	2.0 m CEP
Acquisition ¹		
Cold starts:	26 s	
Aided starts:	2 s	
Reacquisition:	1 s	
Sensitivity ¹		
Tracking & Nav.:	-167 dBm	
Cold starts:	-148 dBm	
Hot starts:	-157 dBm	
Assistance GNSS	AssistNow Online AssistNow Offline (up to 35 days) AssistNow Autonomous (GPS only, up to 3 days) OMA SUPL & 3GPP compliant	
Oscillator	TCXO	
RTC crystal	Built-in	
Anti jamming	Active CW detection and removal; extra onboard SAW band pass filter	
Memory	Onboard ROM	
Supported antennas	Active and passive	
Raw data	Code phase output	
Odometer	Integrated in navigation filter	
Geofencing	Up to 4 circular areas GPIO for waking up external CPU	
Spoofing detection	Built-in	
Signal integrity	Signature feature with SHA 256	

Electrical data

Supply voltage	2.7 V to 3.6 V
Power	22 mA @ 3.0 V (Continuous)
Consumption ¹	6.2 mA @ 3.0 V Power Save mode (1 Hz)
Backup supply	1.4 V to 3.6 V

¹ For default mode: GPS incl. QZSS, SBAS

Package

28 pin LCC (Leadless Chip Carrier): 17.0 x 22.4 x 2.4 mm, 2.1 g

Environmental data, quality & reliability

Operating temp.	-40 °C to +85 °C
Storage temp.	-40 °C to +85 °C
RoHS compliant (lead-free)	
Qualification according to ISO 16750	
Manufactured and fully tested in ISO/TS 16949 certified production sites	
Uses u-blox M8 chips qualified according to AEC-Q100	

Interfaces

Serial interfaces	1 UART 1 USB V2.0 full speed 12 Mbit/s 1 DDC (I ² C compliant)
Digital I/O	Configurable timepulse 2 EXTINT input for Wakeup
Timepulse	Configurable: 0.25 Hz to 10 MHz
Protocols	NMEA, UBX binary, RTCM

Support products

u-blox 8 Evaluation Kits:

Easy-to-use kits to get familiar with u-blox M8 positioning technology, evaluate functionality, and visualize GNSS performance.

EVK-M8N	u-blox M8 GNSS Evaluation Kit, with TCXO, supports LEA-M8S
---------	---

Product variants

LEA-M8S	u-blox M8 concurrent GNSS Module, TCXO, ROM, SAW
---------	---



ZED-F9T module

u-blox F9 high accuracy timing module

Multi-band GNSS receiver with nanosecond-level timing accuracy

- Meets the most stringent 5G timing requirements
- Ideal for global deployments due to GPS, BeiDou, Galileo, and GLONASS reception
- Unaffected by ionospheric errors
- Differential timing mode for highly accurate local timing
- Built-in security for highest robustness against malicious attacks



17.0 × 22.0 × 2.4 mm

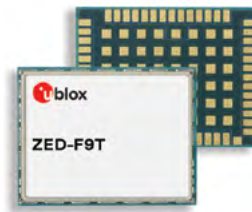

Product description

The ZED-F9T timing module provides nanosecond-level timing accuracy to the most demanding infrastructure applications.

ZED-F9T is designed to meet the most stringent timing synchronization requirements in 5G mobile networks on a global scale. By significantly reducing the time error of the primary source of cellular network synchronization, the ZED-F9T will help operators maximize the performance of their networks and so optimize the return on their investment in 5G communications.

The timing module's multi-band capability reduces the timing error under clear skies to less than 5 ns without the need for an external GNSS correction service. To further improve accuracy locally, the ZED-F9T features differential timing modes that exchange correction data with other neighboring GNSS timing receivers via a communication network.

Multi-band access to all four satellite constellations strengthens the receiver's capability for delivering more reliable performance.

ZED-F9T includes advanced security features such as secure boot, secure interfaces, and T-RAIM to provide the highest level timing integrity.

The module has a single RF input for all the GNSS bands and dual SAW filters for exceptional signal selectivity and out-of-band attenuation.

u-blox modules use GNSS chips qualified according to AEC-Q100, are manufactured in ISO/TS 16949 certified sites, and are fully tested on a system level. Qualification tests are performed as stipulated in the ISO16750 standard: "Road vehicles – Environmental conditions and testing for electrical and electronic equipment".

ZED-F9T

	ZED-F9T
Grade	
Automotive	
Professional	•
Standard	
GNSS	
GPS / QZSS	•
GLONASS	•
Galileo	•
BeiDou	•
Number of concurrent GNSS	4
Multi-band	•
Interfaces	
UART	2
USB	1
SPI	1
DDC (I ² C compliant)	1
Features	
Programmable (Flash)	•
Data logging	•
Carrier phase output	•
Additional SAW	•
RTC crystal	•
Oscillator	T
Survey-in and fixed mode	•
Time pulse output	2
Time mark input	2
Power supply	
2.7 V – 3.6 V	•

T = TCXO



Features

Receiver type	184-channel u-blox F9 engine GPS L1C/A L2C, GLO L1OF L2OF, GAL E1B/C E5b, BDS B1I B2I, QZSS L1C/A L2C SBAS L1C/A: WAAS, EGNOS, MSAS, GAGAN	
Nav. update rate ¹	up to 20 Hz	
Position accuracy ²	Standalone	2.0 m CEP
Acquisition	Cold starts	26 s
	Aided starts	2 s
	Reacquisition	1 s
Sensitivity	Tracking & Nav.	-166 dBm
	Reacquisition	-160 dBm
	Hot starts	-157 dBm
	Cold starts	-148 dBm
Assistance	AssistNow Online OMA SUPL & 3GPP compliant	
Oscillator	TCXO	
RTC crystal	Built-In	
Anti-jamming	Active CW detection and removal Dual onboard band pass filters	
Anti-spoofing	Advanced anti-spoofing algorithms	
Security	Secure boot	
	Secure firmware update	
Memory	Flash	
Supported antennas	Active	

- 1 The highest navigation rate can limit the number of supported constellations
 2 Depends on atmospheric conditions, GNSS antenna, multipath conditions, satellite visibility, and geometry

Features - Timing

Timing accuracy	<5 ns (1-sigma, clear sky, absolute mode)	
	<2.5 ns (1-sigma, clear sky, differential mode)	
Time pulse frequency	0.25Hz – 25 MHz	
Time pulse jitter	±4 ns	
Time mark resolution	8 ns	
Integrity reports	T-RAIM active, phase uncertainty	
	Time pulse rate/duty-cycle, inter-constellation biases	
Survey-in period	Configurable	

Features - Raw data

Measurement data	Carrier phase, code phase & pseudo-range, Doppler on all signals
Message data	GPS, GLONASS, BeiDou, Galileo, QZSS, SBAS

Package

54-pin LGA (Land Grid Array)
17.0 x 22.0 x 2.4 mm

Environmental data, quality & reliability

Operating temp.	-40 °C to +85 °C
Storage temp.	-40 °C to +85 °C
RoHS compliant (lead-free)	
Green (halogen-free)	
ETSI-RED compliant	
Qualification according to ISO 16750	
Manufactured and fully tested in ISO/TS 16949 certified production sites	
Uses u-blox F9 chips qualified according to AEC-Q100	
High vibration and shock resistance	

Electrical data

Supply voltage	2.7 V to 3.6 V
Power consumption	68 mA @ 3.0 V (continuous)
Backup supply	1.65 V to 3.6 V

Interfaces

Serial interfaces	1 USB
	2 UART
	1 SPI
	1 DDC (I ² C compliant)
Protocols	NMEA, UBX binary, RTCM version 3.3
Time pulse output	2
Time mark input	2

Support products

u-blox support products provide reference design, and allow efficient integration and evaluation of u-blox positioning technology.

RCB-F9T	u-blox F9 multi-band GNSS timing board
ANN-MB	Multi-band active GNSS antenna

Product variants

ZED-F9T	u-blox F9 high accuracy timing module
---------	---------------------------------------



LEA-M8F module

u-blox M8 GNSS time & frequency reference module

Multi-GNSS synchronization for cost-sensitive network edge equipment

- Concurrent reception of GPS/QZSS, GLONASS, BeiDou
- Integral disciplined low phase noise 30.72 MHz system reference oscillator
- Accurate measurement and control of external oscillators
- Industry leading acquisition sensitivity and single-satellite timing
- Autonomous 100 ppb hold-over, all effects, including full operating temperature range
- Prepared for integration with external PTP, Sync-E and network listen



17.0 × 22.4 × 3.5 mm



Product description

u-blox time and frequency products provide multi-GNSS synchronisation for cost-sensitive network edge equipment including Small Cell and Femto wireless base-stations. The LEA-M8F module is a fully self-contained phase and frequency reference based on GNSS, but can also be used as part of a complete timing sub-system including macro-sniff Synchronous Ethernet and packet timing.

The LEA-M8F module includes a low-noise 30.72 MHz VCTCXO meeting the master reference requirements for LTE Small Cells and provides 100 ppb autonomous hold-over across its full operating temperature range. The LEA-M8F module can also measure and control an external TCXO or OCXO for TD-LTE, LTE Advanced and other applications requiring extended hold-over. External sources of synchronization are supported through time-pulse and frequency inputs and a message interface. This allows measurements from macro-sniff, Sync-E or packet timing to be combined with measurements from GNSS. The u-blox time and frequency products include timing integrity alarms that report phase and frequency uncertainty both during normal operation and hold-over. They feature a high dynamic range radio with both analog and digital interference mitigation, supporting their inclusion as an integral part of a local area base station design.

Example application (Small Cell)

In a wireless Small Cell application, the LEA-M8F can distribute a disciplined low-phase noise 30.72 MHz reference signal directly to the RF transceivers. GNSS synchronisation is combined with network sources by an exchange of synchronisation signals, status and control messages with the base-band processor. Source selection and hold-over may be controlled by either the LEA-M8F or base-band application.

LEA-M8F

	LEA-M8F
Grade	
Automotive	
Professional	•
Standard	
GNSS	
GPS / QZSS	•
GLONASS	•
Galileo	
BeiDou	•
Number of concurrent GNSS	2
Interfaces	
UART	1
USB	1 (D)
SPI	1
DDC (I ² C compliant)	1
Features	
Programmable (Flash)	•
Additional SAW	•
Additional LNA	•
Oscillator	V
Survey-in and fixed mode	•
Frequency output	•
Timepulse	1
Power supply	
3.0 V – 3.6 V	•

(D) = Development use

V = VCTCXO



Features

Receiver type	72-channel u-blox M8 engine GPS/QZSS L1 C/A, GLONASS L10F, BeiDou B1 SBAS L1 C/A: WAAS, EGNOS, MSAS	
Accuracy	GPS 2.5 m CEP	GLONASS 4.0 m CEP
Acquisition		
Cold starts:	26 s	30 s
Aided cold starts:	2 s	8 s
Sensitivity		
Tracking:	-165 dBm	-165 dBm
Cold start (aided):	-157 dBm	-148 dBm
(autonomous):	-148 dBm	-145 dBm
Reacquisition:	-160 dBm	-157 dBm
Assistance GNSS	AssistNow Online OMA SUPL & 3GPP compliant interface	
Internal oscillator	VCTCXO	
Noise figure	On-chip LNA; Extra LNA for lowest noise figure	
Anti jamming	Active CW detection and removal; extra onboard SAW band pass filter	
Supported antennas	Active and passive	
Internal SQI Flash	For firmware update	

Features – synchronization

Frequency output	30.72 MHz disciplined	
Phase noise	10 Hz: -90 dBc/Hz 10 kHz: -143 dBc/Hz 100 Hz: -120 dBc/Hz 100 kHz: -145 dBc/Hz 1 kHz: -130 dBc/Hz 1 MHz: -149 dBc/Hz	
Jitter (100 Hz - 1 MHz)	0.15 ps	
EVM (100 Hz - 1 MHz @ 2100 MHz)	< 0.2%	
Frequency control (internal oscillator)	GNSS locked: Hold-over:	5 ppb 100 ppb, 24 hr, -40 °C to +85 °C
Frequency control (external oscillator)	Resolution: Frequencies: Hold-over:	< 5 ppb 10, 13, 19.2, 20, 26, 30.72, 40 MHz Determined by external oscillator
Phase control	Clear sky: Indoor:	< 20 ns < 500 ns typ.
Time-pulse input	Resolution:	< 50 ns
Time-pulse output	Jitter:	< 2 ns
Time-pulse frequency	Jitter:	< 2 ns 0.5 Hz to 2 Hz

Electrical data

Supply voltage	3.0 V to 3.6 V
Power consumption	41 mA @ 3.3 V

Package

28 pin LCC (Leadless Chip Carrier): 17.0 x 22.4 x 3.5 mm, 2.0 g

Environmental data, quality & reliability

Operating temp: -40 °C to +85 °C

RoHS compliant (lead-free)

Qualification according to ISO 16750

Manufactured in ISO/TS 16949 certified production sites

Interfaces

Serial interfaces	SPI or UART and DDC (I ² C compliant) USB v2.0 full speed (ext. voltage regulator)
Protocols	NMEA, UBX binary, RTCM
Timing interfaces	Timepulse output 2x timepulse/frequency inputs

Support products

These u-blox M8 support tools are for getting familiar with u-blox M8 positioning technology, evaluating functionality, and visualizing GNSS performance.

EVK-M8F	u-blox M8 Time & Frequency Reference Evaluation Kit, supports LEA-M8F
---------	---

Product variants

LEA-M8F	u-blox M8 Time & Frequency Reference module, Flash, VCTCXO, dual SAW, LNA
---------	---

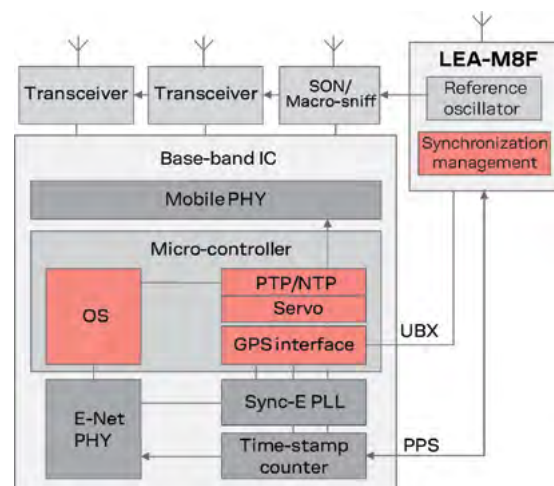



NEO/LEA-M8T series

u-blox M8 GNSS timing modules

Market leading acquisition and tracking sensitivity

- Concurrent reception of GPS/QZSS, GLONASS, BeiDou, and Galileo
- Market leading acquisition and tracking sensitivity
- Optimized accuracy and availability with survey-in and single-satellite timing
- Minimized power consumption with low duty-cycle operation
- Maximized reliability with integrity monitoring and alarms
- Backward compatible with LEA-5T, LEA-6T and NEO-6T



12.2 × 16.0 × 2.4 mm



17.0 × 22.4 × 2.4 mm



Product description

The NEO-M8T and LEA-M8T concurrent GNSS modules deliver high integrity, precision timing in demanding applications world-wide. Support for BeiDou, GLONASS and Galileo constellations enables compliance with national requirements. Enhanced sensitivity and concurrent constellation reception extend coverage and integrity to challenging signal environments. Survey-in and fixed-position navigation reduce timing jitter, even at low signal levels, and enable synchronization to be maintained with as few as one single satellite in view. Support for low duty cycle operation reduces power consumption for battery-powered applications.

u-blox timing products include timing integrity measures with Receiver Autonomous Integrity Monitoring (RAIM) and continuous phase uncertainty estimation. They feature high dynamic range radios with both analog and digital interference mitigation, supporting applications in wireless communications equipment.

The M8T timing modules are delivered in u-blox's established LEA and NEO form-factors with standard pin-out, allowing ready migration from previous product generations.

u-blox timing products can make use of u-blox AssistNow or industry-standard aiding data. This reduces the time-to-first-fix and delivers exceptional acquisition sensitivity, even on first installation before precise location, time or frequency are known.

u-blox M8 modules use GNSS chips qualified according to AEC-Q100, are manufactured in ISO/TS 16949 certified sites, and are fully tested on a system level. Qualification tests are performed as stipulated in the ISO16750 standard: "Road vehicles – Environmental conditions and testing for electrical and electronic equipment".

	NEO-M8T	LEA-M8T
Grade		
Automotive		
Professional	•	•
Standard		
GNSS		
GPS / QZSS	•	•
GLONASS	•	•
Galileo	•	•
BeiDou	•	•
Number of concurrent GNSS	3	3
Interfaces		
UART	1	1
USB	1	1
SPI	1	1
DDC (I ² C compliant)	1	1
Features		
Programmable (Flash)	•	•
Data logging	•	•
Carrier phase output	•	•
Additional SAW	•	•
Additional LNA	•	•
RTC crystal	•	•
Oscillator	T	T
Survey-in and fixed mode	•	•
Timepulse	2	2
Power supply		
2.7 V – 3.6 V	•	•

T = TCXO



Features

Receiver type	72-channel u-blox M8 engine GPS/QZSS L1 C/A, GLONASS L10F, BeiDou B1 SBAS L1 C/A: WAAS, EGNOS, MSAS, GAGAN Galileo E1B/C	
Nav. update rate	Concurrent GNSS: up to 4 Hz	
Position accuracy	2.5 m CEP (Autonomous)	
Acquisition	GPS & GLONASS	GPS & BeiDou
Cold start:	25 s	28 s
Aided cold starts:	2 s	2 s
Sensitivity		
Tracking & Nav:	-167 dBm	-166 dBm
Cold start (aided):	-157 dBm	-157 dBm
(autonomous):	-148 dBm	-148 dBm
Reacquisition:	-160 dBm	-160 dBm
Assistance GNSS	AssistNow GNSS Online AssistNow GNSS Offline (up to 35 days) AssistNow Autonomous (up to 6 days) OMA SUPL & 3GPP compliant	
Oscillator	TCXO	
RTC crystal	Built-in	
Noise figure	On-chip LNA (LEA-M8T) Extra LNA for passive antenna (NEO-M8T)	
Anti jamming	Active CW detection and removal; On-board SAW band pass filter	
Memory	Internal SQI flash for Firmware update	
Supported antennas	Active and passive	

Features - Timing

Timing accuracy	Clear sky:	≤ 20 ns
Time-pulse frequency	0.25 Hz – 10 MHz	
Time-pulse jitter	±11 ns	
Time-mark resolution	21 ns	
Integrity reports	RAIM active, phase uncertainty time-pulse rate/duty-cycle	

Electrical data

Supply voltage	2.7 V to 3.6 V	
Power consumption	15 µA (Battery backup, NEO-M8T) 30 µA (Software backup, NEO-M8T) 32 mA @ 3.0 V (Operational, NEO-M8T) 28 mA @ 3.0 V (Operational, LEA-M8T)	
Backup Supply	1.4 V to 3.6 V	

Interfaces

Serial interfaces	SPI or UART and DDC (I ² C compliant) USB V2.0 full speed 12 Mbit/s	
Protocols	NMEA, UBX binary, RTCM	
Time-pulse outputs	2	
Time-mark inputs	2	

Package

NEO-M8T:	24 pin LCC (Leadless Chip Carrier): 12.2 x 16.0 x 2.4 mm, 1.6 g
LEA-M8T:	28 pin LCC (Leadless Chip Carrier): 17.0 x 22.4 x 2.4 mm, 2.6 g

Features – Raw data and IMES

Measurement data	GPS, GLONASS, BeiDou, SBAS and QZSS (Carrier phase; Code phase & pseudorange; Doppler)
Message data	GPS, GLONASS, BeiDou, SBAS, QZSS L1S and IMES beacons (50/250 bps auto-baud)

Features – Power management

Power-save modes	On/off low duty-cycle
Off control	Hardware, message interface
On control	Hardware, wake-on UART activity, Timer (using low power RTC)
Automatic on/off with configurable period (GPS only)	

Features – Antenna management

NEO-M8T	External with logic-level antenna switching output, filtered continuous supply.
LEA-M8T	Internal antenna bias supply with switching, over-current protection and alarm. Optional input for external open-circuit detection.

Environmental data, quality & reliability

Operating temp.	-40 °C to +85 °C
Storage temp.	-40 °C to +85 °C
RoHS compliant (lead-free)	
Qualification according to ISO 16750	
Manufactured in ISO/TS 16949 certified production sites	
Uses u-blox M8 chips qualified according to AEC-Q100	

Support products

These u-blox M8 support tools are for getting familiar with u-blox M8 positioning technology, evaluating functionality, and visualizing GNSS performance.

EVK-M8T	u-blox M8 Timing GNSS Evaluation Kit
---------	--------------------------------------

Product variants

NEO-M8T	u-blox M8 GNSS LCC module in NEO form factor, Timing, TCXO, flash, SAW, LNA
LEA-M8T	u-blox M8 GNSS LCC module in LEA form factor, Timing, TCXO, flash, SAW

RCB-F9T Timing Board

Easy access to u-blox ZED-F9T multi-band timing technology

Highlights

- Timing board with ZED-F9T
- Industry-standard form factor
- SMB antenna connector
- 8-pin connector for easy connectivity



Product description

The RCB-F9T allows for easy evaluation and quick prototyping with ZED-F9T, the u-blox F9 high accuracy timing module.

The ZED-F9T module provides multi-band GNSS timing and comes with nanosecond level timing accuracy in both standalone and differential timing modes.

The RCB-F9T timing board contains SMB antenna connector and 5V power supply circuitry for active multi-band GNSS antenna. 8-pin, 2.0 mm pitch pin-header provides powering of the board, UART communications and two independently configurable time pulse signals.

The evaluation software, u-center, provides a powerful platform for evaluation of u-blox GNSS receivers. With u-center, the receiver can be easily configured, and data can be logged as well as visualized in real time.

Block diagram



Kit includes

Timing board with ZED-F9T mounted

Pin order

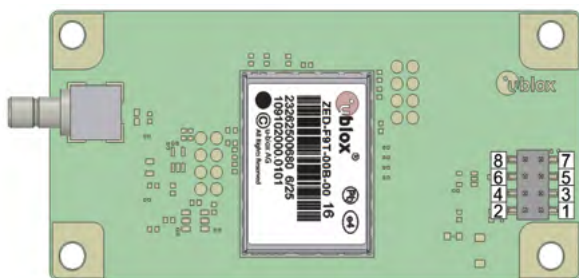

Interfaces and electrical data

Antenna	SMB connector for active multi-band GNSS antenna
Pin header	1 Antenna power supply 5.0V max 100mA 2 Operating voltage, 3.3V 3 UART TXD, LVCMOS 4 Hardware reset (can be left floating) 5 UART RXD, LVCMOS 6 Time Pulse 1, LVCMOS 7 Time Pulse 2, LVCMOS 8 Ground
Protocols	NMEA, UBX, RTCM

Related products

ZED-F9T	u-blox F9 high accuracy timing module
ANN-MB (SMB)	Multi-band, high precision GNSS antenna
u-center	GNSS evaluation software

ANN-MB series

Multi-band, high precision GNSS antennas

Highlights

- Multi-band (L1, L2/E5b/B2I) active GNSS antennas with excellent price-performance ratio
- Supports GPS, GLONASS, Galileo, and BeiDou
- Fast and easy antenna solution for high precision applications
- Versatile mounting and connector options



60.0 x 82.0 x 22.5 mm

Product description

The u-blox ANN-MB multi-band (L1, L2/E5b/B2I) active GNSS antennas are designed to reduce time to market for the next generation of high precision GNSS applications, which require highly accurate location abilities. The compact design, excellent price-performance ratio, and versatile mounting and connector choices provide customers with fast, easy, and reliable multi-band antenna solutions. The ANN-MB antenna is a perfect match to the latest u-blox F9 platform including the ZED-F9P module, thus providing customers with the valuable antenna solution they need to minimize design-in efforts.

Patch antenna characteristics

	L1 Band	L2/E5b/B2I Band
Frequency	1559 - 1606 MHz	1197 - 1249 MHz
VSWR	Max. 2.0	Max. 2.0
Impedance	50 Ω	50 Ω
Peak gain (on Ø15 cm ground plane)	Typ. 3.5 dBic	Typ. 0 - 2.0 dBic
Polarization	RHCP	RHCP

Amplifier characteristics

	L1 Band	L2/E5b/B2I Band
Frequency	1559 - 1606 MHz	1197 - 1249 MHz
Gain without cable (@ 5 V)	28 ± 3.0 dB	28 ± 3.0 dB
Noise figure (@ 5 V)	Max. 2.8 dB	Max. 3.2 dB
Output VWSR	Max. 2.0	Max. 2.0
DC voltage	3.0 - 5.0 V	
DC current (@ 5 V)	Typ. 15.0 mA	

Mechanical data

Weight	173 g (Typ. including cable)
Size	60.0 x 82.0 x 22.5 mm
Cable	5 m RG174 standard
Connectors (choice)	SMA, SMB, MCX
Mounting	Magnetic base, fixed installation option
Housing color	Black

Certifications and approvals

CE approval	Based on Radio Equipment Directive (RED) 2014/53/EU and the Restriction of the use of certain Hazardous Substances Directive (RoHS) 2011/65/EU and 2015/863/EU
-------------	--

Environmental data

Operating temperature	-40 °C to +85 °C
Storage temperature	-40 °C to +85 °C
Water proof	IP 67

Product variants

ANN-MB-00	Multi-band active GNSS antenna with 5 m cable and SMA connector
ANN-MB-01	Multi-band active GNSS antenna with 5 m cable and SMB connector
ANN-MB-02	Multi-band active GNSS antenna with 5 m cable and MCX connector

CAM-M8 series

Omni-directional u-blox M8 GNSS antenna modules

Smart antenna module for omnidirectional GNSS reception

- Concurrent reception of up to 3 GNSS (GPS, Galileo, GLONASS, BeiDou)
- Miniature size and weight with low power consumption
- Embedded, omni-directional and wideband antenna
- Industry leading -167 dBm navigation sensitivity
- Product variants to meet performance and cost requirements
- Optional external antenna



9.6 × 14.0 × 1.95 mm



Product description

The u-blox CAM-M8 series antenna modules are built on the exceptional performance of the u-blox M8 GNSS engine. The CAM-M8 modules utilize concurrent reception of up to three GNSS systems (GPS/Galileo together with either BeiDou or GLONASS), offering high sensitivity and strong signal levels in an ultra compact form factor.

Incorporating the CAM-M8 series modules into customer designs is simple and straightforward, thanks to the embedded GNSS antenna, small footprint of 9.6 x 14 x 1.95 mm, and sophisticated interference suppression that ensures maximum performance even in GNSS-hostile environments. The low power consumption and thin design allow end devices to be slimmer and smaller. The CAM-M8 modules also support message integrity protection, geofencing, and spoofing detection. Despite their miniature size, the chip antennas in the CAM-M8 series modules perform extremely well against traditional patch antennas. Optimal performance is achieved by following design instructions available in the Hardware Integration Manual as the customer PCB is part of the antenna solution. The omnidirectional radiation pattern increases flexibility for device installation. Optionally, CAM-M8 series modules can be connected to an external GNSS antenna. The SMD design keeps manufacturing costs to a minimum and the small mass ensures high reliability.

The CAM-M8 modules target industrial and consumer applications that require concurrent GPS/Galileo and GLONASS or GPS/Galileo and BeiDou reception. The CAM-M8C is optimized for cost-sensitive applications and has the lowest power consumption, while the CAM-M8Q provides best performance. The CAM-M8 modules are form-factor compatible with the UC530 and UC530M modules, allowing the upgrade of existing designs with minimal effort.

CAM-M8 modules use GNSS chips qualified according to AEC-Q100 and are manufactured in ISO/TS 16949 certified sites. Qualification tests are performed as stipulated in the ISO16750 standard: “Road vehicles – Environmental conditions and testing for electrical and electronic equipment”.

	CAM-M8C	CAM-M8Q
Grade		
Automotive		
Professional	•	•
Standard		
GNSS		
GPS / QZSS	•	•
GLONASS	•	•
Galileo	•	•
BeiDou	•	•
Number of concurrent GNSS	3	3
Interfaces		
UART	1	1
USB		
SPI	1	1
DDC (I ² C compliant)	1	1
Features		
Additional SAW	•	•
Additional LNA	•	•
RTC crystal	◆	•
Oscillator	C	T
Built-in antenna	•	•
Timepulse	1	1
Power supply		
1.65 V – 3.6 V	•	
2.7 V – 3.6 V		•

◆ = Yes, but with higher backup current

T = TCXO

C = Crystal



Features

Receiver type	72-channel u-blox M8 engine GPS/QZSS L1 C/A, GLONASS L10F, BeiDou B1 I, Galileo E1B/C SBAS L1 C/A: WAAS, EGNOS, MSAS, GAGAN	
Nav. update rate	Single GNSS:	up to 18 Hz
	2 Concurrent GNSS:	up to 10 Hz
Position accuracy	Autonomous	2.5 m CEP
Acquisition ¹	CAM-M8Q	CAM-M8C
Cold starts:	26 s	26 s
Aided starts:	2 s	3 s
Reacquisition:	1 s	1 s
Sensitivity ¹		
Tracking & Nav.:	-167 dBm	-164 dBm
Cold starts:	-148 dBm	-148 dBm
Hot starts:	-157 dBm	-157 dBm
Assistance GNSS	AssistNow Online AssistNow Offline (up to 35 days) AssistNow Autonomous (GPS only, up to 3 days) OMA SUPL & 3GPP compliant	
Oscillator	TCXO (CAM-M8Q) Crystal (CAM-M8C)	
RTC crystal	Built-In (CAM-M8Q) or cost efficient solution with higher Backup current (CAM-M8C)	
Noise figure	On-chip LNA and extra LNA for lowest noise figure	
Anti jamming	Active CW detection and removal; extra onboard SAW band pass filter	
Memory	Onboard ROM	
Raw Data	Code phase output	
Odometer	Integrated in navigation filter	
Geofencing	Up to 4 circular areas GPIO for waking up external CPU	
Spoofing detection	Built-in	
Signal integrity	Signature feature with SHA 256	

¹ For default mode: GPS incl. QZSS, SBAS

Electrical data

Supply voltage	1.6 V to 3.6 V (CAM-M8C) 2.7 V to 3.6 V (CAM-M8Q)
Digital I/O voltage level	1.6 V to 3.6 V (CAM-M8C) 2.7 V to 3.6 V (CAM-M8Q)
Power	28 mA @ 3.0 V (Continuous)
Consumption ²	10.1 mA @ 3.0 V Power Save mode (1 Hz)
Backup Supply	1.4 V to 3.6 V

² CAM-M8C, GPS/SBAS/QZSS+GLONASS (default mode)

Package

31 pin LCC (Leadless Chip Carrier): 9.6 x 14.0 x 1.95 mm, 0.5 g

Environmental data, quality & reliability

Operating temp.	-40 °C to +85 °C
Storage temp.	-40 °C to +85 °C
RoHS compliant (lead-free)	
Qualification according to ISO 16750	
Manufactured in ISO/TS 16949 certified production sites	
Uses u-blox M8 chips qualified according to AEC-Q100	

Interfaces

Serial interfaces	1 UART 1 SPI (Optional) 1 DDC (I ² C compliant)
Digital I/O	Configurable timepulse 1 EXTINT input for Wakeup
Timepulse	Configurable: 0.25 Hz to 10 MHz
Protocols	NMEA, UBX binary, RTCM

Support products

u-blox M8 Evaluation Kits:

Easy-to-use kits to get familiar with u-blox M8 positioning technology, evaluate functionality, and visualize GNSS performance.

EVK-M8QCAM	u-blox M8 concurrent GNSS evaluation kit (TCXO), supports CAM-M8Q
EVK-M8CCAM	u-blox M8 concurrent GNSS evaluation kit, (Crystal), supports CAM-M8C

Product variants

CAM-M8Q	u-blox concurrent GNSS LCC antenna module, TCXO, SAW, LNA
CAM-M8C	u-blox concurrent GNSS LCC antenna module, Crystal, SAW, LNA



SAM-M8Q module

Easy-to-use u-blox M8 GNSS antenna module

Smart antenna module for easy and reliable integration

- Easy to design-in with no RF expertise required
- Consistently strong performance regardless of installation
- High accuracy thanks to concurrent reception of up to 3 GNSS (GPS, Galileo, GLONASS)
- Tiny form factor 15.5 x 15.5 x 6.3 mm
- Embedded wide-band patch antenna
- Surface-mount device, enabling simple and automated manufacturing



15.5 x 15.5 x 6.3 mm



Product description

SAM-M8Q is the u-blox GNSS patch antenna module that is ideal for easy and reliable GNSS integration. With the exceptional performance of the u-blox M8 concurrent GNSS (GPS, GLONASS, Galileo, QZSS and SBAS) engine, the SAM-M8Q delivers high sensitivity and minimal acquisition times in an ultra compact form factor.

Incorporating the SAM-M8Q module into customer designs is simple and straightforward, thanks to the embedded GNSS patch antenna, low power consumption, simple interface, and sophisticated interference suppression that ensures maximum performance even in GNSS-hostile environments.

The 15 x 15 mm patch antenna provides the best compromise between the performance of a Right Hand Circular Polarized (RHCP) antenna and a small size to be integrated in any design. The omni-directional radiation pattern increases flexibility for device installation. SAM-M8Q's robustness, easy design-in, surface embedded antenna, and easy interfacing ensure faster time to market and keep design and manufacturing costs to a minimum.

The SAM-M8Q module features an additional front-end LNA for optimized performance and a front-end SAW filter for increased jamming immunity.

The SAM-M8Q module targets industrial and consumer applications that require small, cost efficient, and ready-to-use GNSS solutions. SAM-M8Q is based on the u-blox M8 FW3 engine with cutting-edge performance and additional features not available on any other antenna modules in the market. It also provides message integrity protection, geofencing, spoofing detection, and odometer functionalities.

The SAM-M8Q module uses AEC-Q100 qualified GNSS chips and is fully tested at the system level. Qualification is done according to ISO16750 standard.

SAM-M8Q

Grade	
Automotive	
Professional	•
Standard	
GNSS	
GPS / QZSS	•
GLONASS	•
Galileo	•
BeiDou	
Number of concurrent GNSS	3
Interfaces	
UART	1
USB	
SPI	
DDC (I ² C compliant)	1
Features	
Additional SAW	•
Additional LNA	•
RTC crystal	•
Oscillator	T
Built-in antenna	•
Timepulse	1
Power supply	
2.7 V – 3.6 V	•

T = TCXO



Features

Receiver type	72-channel u-blox M8 engine GPS/QZSS L1 C/A, GLONASS L1OF Galileo E1B/C SBAS L1 C/A: WAAS, EGNOS, MSAS, GAGAN
Nav. update rate	Single GNSS: up to 18 Hz 2 Concurrent GNSS: up to 10 Hz
Position accuracy	2.5 m CEP
Acquisition ¹	
Cold starts:	26 s
Aided starts:	2 s
Reacquisition:	1 s
Sensitivity ¹	
Tracking & Nav.:	-165 dBm
Cold starts:	-146 dBm
Hot starts:	-155 dBm
Assistance GNSS	AssistNow Online AssistNow Offline (up to 35 days) AssistNow Autonomous (up to 3 days) OMA SUPL & 3GPP compliant
Oscillator	TCXO
RTC crystal	Built-in
Noise figure	On-chip LNA and extra LNA for lowest noise figure
Anti jamming	Active CW detection and removal; extra onboard SAW band pass filter
Memory	Onboard ROM
Raw Data	Code phase output
Odometer	Integrated in navigation filter
Geofencing	Up to 4 circular areas GPIO for waking up external CPU
Spoofing detection	Built-in
Signal integrity	Signature feature with SHA 256

¹ Default mode: GPS/SBAS/QZSS+GLONASS

Electrical data

Supply voltage	2.7 V to 3.6 V
Digital I/O voltage level	2.7 V to 3.6 V
Power Consumption (2 concurrent GNSS)	29 mA @ 3.0 V (Continuous) 9.5 mA @ 3.0 V Power Save mode (1 Hz)
Backup Supply	1.4 V to 3.6 V

Package

20 pin LGA (Land Grid Array): 15.5 x 15.5 x 6.3 mm, 6 g

Environmental data, quality & reliability

Operating temp.	-40°C to +85°C
RoHS compliant (lead-free)	
Qualification according to ISO 16750	
Uses u-blox M8 chips qualified according to AEC-Q100	

Interfaces

Serial interfaces	1 UART 1 DDC (I ² C compliant)
Digital I/O	Configurable timepulse 1 EXTINT input for Wakeup
Timepulse	Configurable: 0.25 Hz to 10 MHz
Protocols	NMEA, UBX binary, RTCM

Support products

u-blox M8 Evaluation Kits:

Easy-to-use kits to get familiar with u-blox M8 positioning technology, evaluate functionality, and visualize GNSS performance.

EVK-M8QSAM	u-blox M8 concurrent GNSS evaluation kit supports SAM-M8Q
------------	---

Product variants

SAM-M8Q	u-blox concurrent GNSS LCC antenna module, TCXO, SAW, LNA
---------	---

Positioning chips





u-blox positioning chips

Based on a proprietary high-performance architecture, u-blox's powerful range of GNSS positioning chips are ideal for automotive, industrial and consumer applications.

Key benefits include

- Ultra-fast acquisition time: Time-To-First-Fix (TTFF) down to 1 second for hot and aided starts
- High sensitivity: down to -167 dBm (-148 dBm for cold start)
- Ultra-robust meter-level positioning with maximum satellite availability thanks to concurrent reception of 4 GNSS (UBX-M9140)
- Super-Efficient low-power GNSS (UBX-M8230-CT)
- Automotive Dead Reckoning options (UBX-M8030-Kx-DR)
- Intelligent, user-configurable power management for radically lower power consumption
- Minimal e-BOM
- Works with crystal or TCXO
- Anti-jamming architecture allows easy embedding in noisy electronics
- Automotive grade versions, extended operating temperature: -40 °C to $+105$ °C
- Concurrent reception of GPS/QZSS, GLONASS, BeiDou, and Galileo
- Assisted GNSS support (AssistNow)



UBX-M9140

u-blox M9 standard precision GNSS chips

Ultra-robust meter-level GNSS positioning chips

- Maximum position availability with concurrent reception of 4 GNSS
- 25 Hz position update rate for dynamic applications
- Advanced spoofing and jamming detection
- Migration path to dead reckoning and high precision technology



5.00 × 5.00 × 0.59 mm



Product description

The UBX-M9140 chips are part of the u-blox M9 standard precision GNSS platform, and provide exceptional sensitivity and acquisition times for all L1 GNSS systems. The u-blox M9 standard precision GNSS platform, which delivers meter-level accuracy performance, succeeds the well-known u-blox M8 product range.

The UBX-M9140 chips are available in different variants to serve automotive and industrial tracking applications, such as navigation, telematics and UAVs.

UBX-M9140 supports concurrent reception of four GNSS. The high number of visible satellites enables the receiver to select the best signals. This maximizes the position accuracy, in particular under challenging conditions such as in deep urban canyons.

UBX-M9140 offers a position update rate of up to 25 Hz. This allows dynamic applications such as UAVs to receive the position information with low latency.

UBX-M9140 detects jamming and spoofing events and reports them to the host, so that the system can react to such events. Advanced filtering algorithms mitigate the impact of RF interference and jamming, thus enabling the product to operate as intended.

Thanks to a uniform pinout, customers avoid multiple designs when using different variants of UBX-M9140. The same PCB layout can feature different technologies, such as with or without dead reckoning.

	UBX-M9140-KA	UBX-M9140-KB
Grade		
Automotive	•	
Professional		•
Standard		
GNSS		
GPS + QZSS/SBAS	•	•
GLONASS	•	•
Galileo	•	•
BeiDou	•	•
Number of concurrent GNSS	4	4
Interfaces		
UART	2	2
USB	1	1
SPI	1	1
DDC (I2C compliant)	1	1
Features		
Upgradeable firmware	•	•
Data logging	S	S
RTC crystal	S	S
Oscillator	T	T
Antenna supply & supervisor	S	S
Timepulse	2	2

S = supported, may require ext. components

T = TCXO



Product performance

Receiver type	92-channel u-blox M9 engine GPS L1 C/A, QZSS L1 C/A/S, GLONASS L10F, BeiDou B1I, Galileo E1B/C, SBAS L1 C/A: WAAS, EGNOS, MSAS, GAGAN	
Nav. update rate	Up to 25 Hz (4 concurrent GNSS)	
Horizontal position accuracy ¹	1.5 m CEP	
Acquisition ¹	Cold start	24 s
	Aided start	2 s
	Hot start	2 s
Sensitivity ¹	Tracking & Nav.	-167 dBm
	Reacquisition	-160 dBm
	Cold start	-148 dBm
	Hot start	-159 dBm

External components

Oscillator	TCXO
RTC input	32.768 kHz (optional)
Antenna supply & supervisor	External circuit required for short and open circuit detection
Flash memory	SPI, minimum 8 MBit
DC/DC converter	Built-in, external component required

Tracking features

Power save modes	On/off, cyclic
Data batching	Autonomous tracking up to 10 min
Data-logger ²	Position, velocity, time, and odometer data
Geo-fencing	Up to 4 circular areas; GPIO for waking up the host CPU

Security features

Signal integrity	RF interference & jamming detection and reporting Active GNSS in-band filtering Spoofing detection and reporting
Device integrity	Secure boot of firmware downloaded from host or flash Receiver configuration lock by command
Secure interface	Signed UBX messages (SHA-256) JTAG debug interface disabled by default

Package

40 pin QFN: 5.00 x 5.00 x 0.59 mm

Environmental data, quality & reliability

Operating temp.	-40°C to +85°C (UBX-M9140-KB) -40°C to +105°C (UBX-M9140-KA)
Storage temp.	-40°C to +125°C
MSL	1
Environmental grade	2015/863/EU RoHS-3, Green, IEC-61249-2-21 halogen-free
Environmental testing	AEC-Q100
Quality management	Manufactured and fully tested in IATF 16949 certified production sites AEC-Q004 Zero ppm strategy (UBX-M9140-KA)

Electrical data

Supply voltage	1.8 V or 3 V
Power consumption	32 mA @ 3.0 V (4 GNSS continuous) 29 mA @ 3.0 V (2 GNSS continuous) 23 mA @ 3.0 V (1 GNSS continuous)
Backup Supply	1.65 V to 3.6 V

Interfaces

Serial interfaces	2 UART 1 USB V2.0 full speed 12 Mbit/s 1 DDC (I2C compliant) 1 SPI
Digital I/O	2 configurable time pulse 2 EXTINT interrupt inputs 2 PIO for antenna supervision
Raw Data output	Code phase data
Memory	SPI interface for optional Flash
Protocols	NMEA 4.10, UBX binary, RTCM 3.3

Services

GNSS Assistance	AssistNow GNSS Online AssistNow GNSS Offline (up to 35 days) AssistNow Autonomous (up to 6 days)
-----------------	--

Support products

XPLR-M9	u-blox M9 GNSS Explorer Kit with easy-to-use software for first product evaluation
EVK-M91	u-blox M9 GNSS Evaluation Kit with UBX-M9140 chip and I/O interface

Product variants

UBX-M9140-KA	u-blox M9 GNSS chip, 40 pin QFN
UBX-M9140-KB	u-blox M9 GNSS chip, 40 pin QFN

1 = For default mode: GPS/GLO/BDS/GAL+SBAS/QZSS
2 = External Flash required



UBX-M8230-CT

Super low power u-blox M8 GNSS chip

Ideal for portable applications thanks to Super-E mode

- Super-E mode: ideal balance between low power and good performance
- Optimized for portable & wrist-worn applications
- System power optimization: LNA power saving and data batching
- Concurrent reception of GPS, GLONASS, BeiDou in Super-E mode
- Minimal board space: less than 30 mm²



2.99 × 3.21 × 0.36 mm

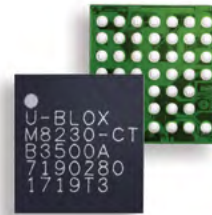

Product description

The UBX-M8230-CT is an ultra low power GNSS chip optimized for wearable and portable applications. It features Super-E mode (Super-Efficient), providing a unique balance between power and performance. Compared with u-blox 1 Hz full power mode, the Super-E mode provides up to 3 times the power savings while maintaining good position and speed accuracy. Average power consumption over a typical 30-minute track can be lower than 20 mW, while instantaneous tracking power is less than 10 mW. This is true even when using an industrial antenna design with moderate-to-low signal levels.

Super-E has a default performance setting for the best balance between power vs. performance. It also has a power save setting for additional power savings with potential compromise on performance.

The UBX-M8230-CT optimizes the overall system power consumption by excluding the need for any heavy signal processing on the application processor, and with external components, such as an external LNA, that can be automatically duty cycled. Navigation data can be stored internally while the application processor is in deep sleep (data batching).

Used in combination with multi-GNSS Assistance data, the UBX-M8230-CT features faster Time-to-First-Fix and ensures minimal power consumption.

The UBX-M8230-CT only needs a few external components (e.g. SAW/LNA) to form a full GNSS solution with a footprint as small as 30 mm². It offers easy access to navigation data via multiple interfaces, such as SPI, I2C and UART.

The UBX-M8230-CT chip is an ideal choice for most wearable applications, such as watches, sport trackers and other applications where low power consumption and small size are key.

The UBX-M8230-CT is built on the u-blox M8 concurrent engine and supports two constellations simultaneously in Super-E mode, thus increasing the number of visible satellites compared to single-GNSS solutions. It also supports message integrity protection, anti-jamming, and anti-spoofing, providing reliable positioning in difficult environmental conditions as well as in security attack scenarios.

The UBX-M8230-CT chip is fully tested and qualified according to the JESD47 standard.

UBX-M8230-CT

Grade	
Automotive	
Professional	
Standard	•
GNSS	
GPS / QZSS	•
GLONASS	•
Galileo	cm
BeiDou	•
Number of concurrent GNSS	3
Interfaces	
UART	1
USB	
SPI	1
DDC (I ² C compliant)	1
Features	
Data logging	S
Data batching	•
RTC crystal	S
Oscillator	T

cm = only supported in continuous mode
S = supported, may require ext. components

T = TCXO supported



Features

Receiver type	72-channel u-blox M8 engine GPS/QZSS L1 C/A, GLONASS L1OF BeiDou B1I, Galileo E1B/C 1 SBAS L1 C/A: WAAS, EGNOS, MSAS, GAGAN	
Time to first fix		
Cold starts:	26 s	
Aided start:	2 s	
Hot start:	1 s	
	Super-E mode (default)	Continuous mode
Sensitivity ²		
Tracking & Nav:	-160 dBm	-167 dBm
Reacquisition:	-160 dBm	-160 dBm
Cold start:	-148 dBm	-148 dBm
Hot start:	-157 dBm	-157 dBm
Max nav. update rate		
Single GNSS	Up to 4 Hz	up to 18 Hz
2 Concurrent GNSS	Up to 4 Hz	up to 10 Hz
Horizontal Pos.	3.5 m CEP	2.5 m CEP
Accuracy		
Multi-GNSS Assistance	AssistNow GNSS Online AssistNow GNSS Offline (up to 35 days) AssistNow Autonomous (up to 6 days) OMA SUPL & 3GPP compliant	
Oscillator	Supports TCXO	
Real Time Clock (RTC)	Can be derived from external RTC Clock	
LNA	Built-in	
DC/DC converter	Built-in, external component required	
Super-E mode	Super Efficient mode for lowest power	
Anti Jamming	Active CW detection and removal	
SQL Flash (optional)	For AssistNow Offline, AssitNow Autonomous, long term logging	
Raw Data	Code phase output	
Odometer	Integrated in navigation filter	
Geofencing	Up to 4 circular areas GPIO for waking up external CPU	
Spoofing detection	Built-in	
Signal integrity	Signature feature with SHA 256	
Data logging ³ and Data batching	For position, velocity, time, and odometer data	

1 Galileo only supported in continuous mode

2 GPS+GLONASS

3 External Flash required

Interfaces

Serial interfaces	1 UART 1 DDC (I ² C compliant) 1 SPI
Digital I/O	1 EXTINT interrupt inputs
Memory	SQL interface for optional Flash

Package

UBX-M8230-CT: 47 Pin WL-CSP: 2.99 x 3.21 x 0.36 mm

Environmental data, quality & reliability

Operating temp.	-40 °C to +85 °C
Humidity	JEDEC MSL 1
RoHS compliant (lead-free) and green (no halogens)	
Qualification according to JESD47	

Electrical data

Supply voltage	1.4 V to 3.6 V
Digital I/O voltage level	1.65 V to 3.6 V
Power consumption ⁴	36 mA @ 1.4 V (continuous mode, 1 Hz) 6 mA @ 1.4 V (Super-E mode, performance setting, 1 Hz) 4.8 mA @ 1.4 V (Super-E mode, power save setting, 1 Hz)
Backup Supply	1.4 V to 3.6 V

4 = Tracking, 2 concurrent GNSS

Support products

u-blox M8 Evaluation Kits:
Easy-to-use kits to get familiar with u-blox M8 positioning technology, evaluate functionality, and visualize GNSS performance.

EVK-M8230 u-blox M8 low power GNSS evaluation kit, supports UBX-M8230-CT chip

Product variants

UBX-M8230-CT u-blox M8 low power concurrent GNSS chip, 47 pin WL-CSP



UBX-M8030

Versatile u-blox M8 GNSS chips

Versatile GNSS chips in three product grades

- Concurrent reception of up to 3 GNSS (GPS, Galileo, GLONASS, BeiDou)
- Industry leading -167 dBm navigation sensitivity
- Industry lowest current consumption
- Superior position accuracy in urban canyons
- Security and integrity protection
- Support for all satellite augmentation systems
- Operating temperature range of -40 °C to +105 °C for the automotive grade chip



2.99 × 3.21 × 0.36 mm



5.00 × 5.00 × 0.59 mm



Product description

The UBX-M8030 high performance standard precision GNSS chips from u-blox provide exceptional sensitivity and acquisition times for all GNSS systems. The chips utilize concurrent reception of up to three GNSS systems (GPS/Galileo together with either Beidou or GLONASS). Reception from more than one constellation simultaneously allows extraordinary positioning accuracy in urban canyons, even with weak signals and high dynamics.

The UBX-M8030 chips feature low power consumption in concurrent reception mode and support advanced Power Save Modes for all GNSS, the power consumption remains low even for weak signals. The UBX-M8030 chips also support message integrity protection, geofencing and spoofing detection with configurable interface settings to easy fit to customer applications. The firmware supports QZSS, GAGAN and IMES together with WAAS, EGNOS, and MSAS.

UBX-M8030 chips are available in miniature WL-CSP and QFN packages. Featuring built-in LNA, LDOs and a DC/DC converter, and a small external BOM, the UBX-M8030 enables ultra-small solutions with a footprint of only 30 mm². Supporting TCXOs or lower price oscillators further ensures a minimal Total-Cost-of-Ownership.

The ultra small UBX-M8030-CT is a perfect choice for portable consumer applications with demanding size and cost constraints. Including rigorous automotive quality and manufacturing standards, extended testing and low failure rate make the UBX-M8030-KA chip ideal for automotive applications. With UBX-M8030-KA's operational temperature from -40 °C to +105 °C, a new industry standard is set.

Migration from existing FW2 based u-blox M8030 chip designs are simple, since the upgraded UBX-M8030 offers backward compatibility.

	UBX-M8030-CT	UBX-M8030-KT	UBX-M8030-KA*
Grade			
Automotive			•
Professional		•	•
Standard	•		
GNSS			
GPS / QZSS	•	•	•
GLONASS	•	•	•
Galileo	•	•	•
BeiDou	•	•	•
Number of concurrent GNSS	3	3	3
Interfaces			
UART	1	1	1
USB	1	1	1
SPI	1	1	1
DDC (I ² C compliant)	1	1	1
Features			
Programmable (Flash)	S	S	S
Data logging	S	S	S
RTC crystal	S	S	S
Oscillator	C/T	C/T	C/T
Antenna supply & supervisor	S	S	S
Timepulse	2	2	2

S = supported, may require ext. components C/T = Crystal and TCXO supported
 * = Operating temperature -40 °C to +105 °C



Features

Receiver type	72-channel u-blox M8 engine GPS/QZSS L1 C/A, GLONASS L10F BeiDou B1, Galileo E1B/C SBAS L1 C/A: WAAS, EGNOS, MSAS, GAGAN	
Time to first fix ¹		
Cold starts:	26 s	
Aided start:	2 s	
Hot start:	1 s	
Sensitivity ¹		
Tracking & Nav:	-167 dBm	
Reacquisition:	-160 dBm	
Cold start:	-148 dBm	
Hot start:	-157 dBm	
Nav. update rate ²	Single GNSS	up to 18 Hz
	2 Concurrent GNSS	up to 10 Hz
Horizontal Pos. Accuracy ¹	2.0 m CEP	
Multi-GNSS Assistance	AssistNow GNSS Online AssistNow GNSS Offline (up to 35 days) AssistNow Autonomous (up to 6 days)	
Oscillator	Supports Crystal or TCXO	
LNA	Built-in	
RTC input	32.768 kHz (optional), RTC can be derived from GNSS Crystal or TCXO	
Antenna supervision	Short and open circuit detection supported with external circuit	
DC/DC converter	Built-in, external component required	
Anti Jamming	Active CW detection and removal	
SQI flash (optional) for	FW update AssistNow Offline AssistNow Autonomous	
Raw Data	Code phase output	
Odometer	Integrated in navigation filter	
Geo-fencing	Up to 4 circular areas; GPIO for waking up external CPU	
Spoofing detection	Built-in	
Signal integrity	Signature feature with SHA 256	
Data-logger ³	For position, velocity, time, and odometer data	

1 = For default mode: GPS/SBAS/QZSS+GLONASS with TCXO

2 = ROM

3 = External Flash required

Electrical data

Supply voltage	1.4 V to 3.6 V	
Digital I/O voltage level	1.65 V to 3.6 V	
Power consumption (2 concurrent GNSS)	21 mA @ 3.0 V (Continuous)	
	5.3 mA @ 3.0 V (PSM, 1 Hz)	
Backup Supply	1.4 V to 3.6 V	

Package

UBX-M8030-CT: 47 pin WL-CSP:	2.99 x 3.21 x 0.36 mm
UBX-M8030-KT/KA: 40 pin QFN:	5.00 x 5.00 x 0.59 mm

Environmental data, quality & reliability

Operating temp.	-40°C to +85°C (UBX-M8030-CT, UBX-M8030-KT) -40°C to +105°C (UBX-M8030-KA)
Storage temp.	-40 °C to +125 °C
Humidity	JEDEC MSL 1
RoHS compliant (lead-free) and green (no halogens)	
Qualification according to AEC-Q100	
Manufactured in ISO/TS 16949 certified production sites	

Interfaces

Serial interfaces	1 UART 1 USB V2.0 full speed 12 Mbit/s 1 DDC (I ² C compliant) 1 SPI
Digital I/O	2 configurable time pulse 2 EXTINT interrupt inputs 2 PIO for antenna supervision
Memory	SQI interface for optional Flash

Support products

u-blox M8 Evaluation Kits:
Easy-to-use kits to get familiar with u-blox M8 positioning technology, evaluate functionality, and visualize GNSS performance.

EVK-M8N	u-blox M8 GNSS Evaluation Kit, which supports TCXO-based u-blox M8 designs
EVK-M8C	u-blox M8 GNSS Evaluation Kit, which supports crystal-based u-blox M8 designs

Product variants

UBX-M8030-CT	u-blox M8 GNSS chip, 47 pin WL-CSP
UBX-M8030-KT	u-blox M8 GNSS chip, 40 pin QFN
UBX-M8030-KA	u-blox M8 GNSS chip, 40 pin QFN



UBX-G8020-KT

u-blox 8 GPS chip

Cost-efficient low power GPS chip

- GNSS engine for GPS/QZSS and GLONASS
- High sensitivity of -166 dBm
- Low power consumption
- Advanced jamming and spoofing detection
- Superior performance for wrist worn devices
- Pin-compatible with UBX-G7020-KT and UBX-M8030-KT



Standard



Professional



Automotive

5.00 × 5.00 × 0.59 mm



UBX-G8020-KT

Product description

The UBX-G8020-KT GNSS chip, based on the latest u-blox 8 position engine, supports GPS/QZSS, GLONASS, and SBAS. With superior sensitivity and acquisition times, it sets new standards for single constellation receivers.

UBX-G8020-KT chip is targeted for applications where small size, high performance, minimal power, and low system costs are all a must. With a dedicated mode for wrist worn applications, UBX-G8020-KT is a perfect choice for wearable devices. UBX-G8020-KT features low power consumption and supports advanced Power Save Modes. It also provides message integrity protection, geofencing, spoofing detection, odometer, and data logging functionalities.

The UBX-G8020-KT is available in an industry standard QFN package. Featuring built-in LNA, LDOs and DC/DC converter, and a small external BOM, the UBX-G8020-KT enables ultra-small solutions with a footprint of only ~50 mm². By supporting TCXOs or lower price oscillators, the UBX-G8020-KT further ensures a minimal Total-Cost-of-Ownership.

UBX-G8020-KT was built with backward compatibility in mind, thus simplifying migration from existing u-blox G7020-KT designs.

With its rigorous quality and manufacturing standards (AEC-Q100, ISO/TS 16949), UBX-G8020-KT meets the requirements for industrial and consumer applications.

	UBX-G8020-KT
Grade	
Automotive	
Professional	•
Standard	
GNSS	
GPS / QZSS	•
GLONASS	•
Galileo	
BeiDou	
Number of concurrent GNSS	1
Interfaces	
UART	1
USB	1
SPI	1
DDC (I ² C compliant)	1
Features	
Data logging	S
RTC crystal	S
Oscillator	C/T
Antenna supply & supervisor	S
Timepulse	2

S = supported, may require ext. components C/T = Crystal and TCXO supported



Features

Receiver type	72-channel u-blox 8 engine GPS/QZSS L1 C/A, GLONASS L10F SBAS L1 C/A: WAAS, EGNOS, MSAS	
Time to first fix ¹	GPS	GLONASS
Cold starts:	29 s	30 s
Aided start:	2 s	2 s
Hot start:	1 s	1 s
Sensitivity ¹		
Tracking & Nav:	-166 dBm	-166 dBm
Reacquisition:	-160 dBm	-156 dBm
Cold start:	-148 dBm	-145 dBm
Hot start:	-157 dBm	-156 dBm
Max nav. update rate	Up to 18 Hz	
Horizontal Pos. Accuracy	GPS 2.5 m CEP	GLONASS 4.0 m CEP
Multi-GNSS Assistance	AssistNow GNSS Online AssistNow GNSS Offline (up to 35 days) AssistNow Autonomous (up to 6 days)	
Oscillator	Supports Crystal or TCXO	
LNA	Built-in	
RTC input	32.768 kHz (optional), RTC can be derived from GNSS Crystal	
Antenna supervision	Short and open circuit detection supported with external circuit	
DC/DC converter	Built-in, external component required	
Anti Jamming	Active CW detection and removal	
Raw Data	Code phase output	
Odometer	Integrated in navigation filter	
Geofencing	Up to 4 circular areas; GPIO for waking up external CPU	
Spoofing detection	Built-in	
Signal integrity	Signature feature with SHA 256	
Data logging ²	For position, velocity, time, and odometer data	

1 = with TCXO

2 = External Flash required

Package

UBX-G8020-KT: 40 Pin QFN: 5.00 x 5.00 x 0.59 mm

Environmental data, quality & reliability

Operating temp.	-40 °C to +85 °C
Storage temp.	-40 °C to +125 °C
Humidity	JEDEC MSL 1
RoHS compliant (lead-free) and green (no halogens)	
Qualification according to AEC-Q100	
Manufactured in ISO/TS 16949 certified production sites	

Electrical data

Supply voltage	1.4 V to 3.6 V
Digital I/O voltage level	1.65 V to 3.6 V
Power consumption	16 mA @ 3.0 V (continuous mode) 3.7 mA @ 3.0 V (PSM, 1 Hz update)
Backup Supply	1.4 V to 3.6 V

Interfaces

Serial interfaces	1 UART 1 USB V2.0 compatible 1 DDC (I ² C compliant) 1 SPI
Digital I/O	2 configurable time pulses 2 EXTINT interrupt inputs 2 PIO for antenna supervision

Support products

Easy-to-use kits to get familiar with u-blox 8 positioning technology, evaluate functionality, and visualize GNSS performance.

EVK-8N u-blox 8 GNSS Evaluation Kit with TCXO

Product variants

UBX-G8020-KT u-blox 8 GNSS chip, 40 pin QFN



UBX-M8030-Kx-DR

u-blox M8 ADR GNSS chips



Standard



Professional



Automotive

Continuous accurate navigation under all signal conditions

- Speed and sensor information from vehicle
- Support for directly connected 3D sensors
- Continuous navigation during signal loss
- Automatic configuration of wheel-tick/speed input
- Real-time positioning up to 30 Hz rate
- GPS/QZSS, GLONASS, BeiDou, Galileo
- Operating temperature range -40 °C to +105 °C for the automotive grade chip

5.00 × 5.00 × 0.59 mm



Product description

The M8030-KT-DR and automotive-grade M8030-KA-DR chips offer u-blox's fourth generation Automotive Dead Reckoning (ADR) technology designed to meet the needs of the latest interactive navigation systems and displays. The performance of these products benefits from experience in demanding, first-fit passenger car applications, the latest multi-axis sensor technology and advancements in u-blox's multi-GNSS signal processing, particularly in highly urban environments.

u-blox's latest ADR technology introduces a new High Navigation Rate class of positioning outputs. The intelligent combination of GNSS and sensor measurements enables accurate, real-time position, speed, and heading information at rates up to 30 Hz, as essential for smooth and responsive interactive display.

u-blox's ADR chips support Dead Reckoning with single and differential wheel-ticks, gyroscope, and accelerometer sensors, and they incorporate map-matching feedback where available. The latest generation supports wheel ticks and 3D sensors connected directly to the receiver, which provides a useful saving in eBOM and the benefits of reduced latency. Flexible automatic configuration reduces the number of product variants required to support multiple applications.

The M8030 family includes u-blox's latest generation GNSS technology, which adds Galileo to the multi-constellation reception that already includes GPS, GLONASS, BeiDou and QZSS. These chips provide high sensitivity and fast GNSS signal acquisition and tracking.

The UBX-M8030-Kx chips are qualified according to AEC-Q100, and are manufactured in ISO/TS 16949 certified sites.

	UBX-M8030-KT-DR	UBX-M8030-KA-DR
Grade		
Automotive		•
Professional	•	
Standard		
GNSS		
GPS / QZSS	•	•
GLONASS	•	•
Galileo	•	•
BeiDou	•	•
Number of concurrent GNSS	3	3
Interfaces		
UART	1	1
USB	1	1
SPI	1	1
DDC (I ² C compliant)	1	1
Features		
Programmable (Flash)	•	•
Data logging	•	•
RTC crystal	S	S
Oscillator	C/T	C/T
Antenna supply & supervisor	S	S
Timepulse	2	2

S = supported, may require ext. components C/T = Crystal and TCXO supported



Features

Receiver type	72-channel u-blox M8 engine GPS/QZSS L1 C/A, GLONASS L10F, BeiDou B1 I, Galileo E1B/C SBAS L1 C/A: WAAS, EGNOS, MSAS, GAGAN	
Time to first fix ¹		
Cold starts:	26 s	
Aided start:	2 s	
Hot start:	1 s	
Sensitivity ¹		
Tracking & Nav:	-160 dBm	
Reacquisition:	-160 dBm	
Cold start:	-148 dBm	
Hot start:	-157 dBm	
Nav. update rate	Up to 30 Hz	
Velocity accuracy	0.05 m/s	
Heading accuracy	0.3 degrees	
Position accuracy	Autonomous:	2.0 m CEP
	with SBAS:	1.5 m CEP
Sensor configuration	Wheel ticks, gyro, accelerometer differential wheel ticks, map-match feedback	
Multi-GNSS Assistance	AssistNow GNSS Online AssistNow GNSS Offline (up to 35 days) AssistNow Autonomous (up to 6 days)	
Oscillator	Supports Crystal or TCXO	
LNA and outband filtering	On-chip LNA	
RTC input	32.768 kHz (optional), RTC can be derived from GNSS Crystal or TCXO	
Antenna supervision	Short and open circuit detection supported with external circuit	
DC/DC converter	Built-in, external component required	
Anti Jamming	Active CW detection and removal	
SQI flash supported	Required for ADR AssistNow Offline, AssistNow Autonomous improved performance, and data logger	

1 = GPS + GLONASS

2 = Limited by FW for best DR performance

Package

UBX-M8030-KA-DR/UBX-M8030-KT-DR: 40 Pin QFN:
5.00 x 5.00 x 0.59 mm

Environmental data, quality & reliability

Operating temp.	-40 °C to +85 °C (UBX-M8030-KT-DR) -40 °C to +105 °C (UBX-M8030-KA-DR)
Storage temp.	-40 °C to +125 °C
Humidity	JEDEC MSL 1
RoHS compliant (lead-free) and green (no halogens)	

ADR performance and requirements

u-blox ADR supports standard sensor configurations: Rear wheel sensors, front wheel sensors, four wheel sensors, gyro + speedpulse + accelerometer (optional).

Sensor option		Typical position error
Front wheels	(2D)	14%
Rear wheels	(2D)	12%
Four wheels	(2D)	10%
Gyro + speedpulse	(2D)	3%
Gyro + speedpulse + accelerometer	(3D)	2%

Electrical data

Supply voltage	1.4 V to 3.6 V
Digital I/O voltage level	1.65 V to 3.6 V
Power consumption (continuous mode)	18 mA @ 3.0 V (single GNSS) 22 mA @ 3.0 V (concurrent GNSS)
Backup Supply	1.4 V to 3.6 V

Interfaces

Serial interfaces	1 UART 1 USB V2.0 full speed 12 Mbit/s 1 DDC (I ² C compliant) 1 DDC (I ² C compliant) sensor interface 1 SPI
Digital I/O	Configurable time pulse 1 EXTINT interrupt inputs 10 PIO for antenna supervision
Memory	SQI interface

Support products

Contact nearest u-blox representative.

Product variants

UBX-M8030-KT-DR	u-blox M8 3D ADR chip, Professional Grade
UBX-M8030-KA-DR	u-blox M8 3D ADR chip, Automotive Grade

Previous generations



OVERVIEW

To help you choose the best current product for your future applications, we provide a list of older established products that are still in production. The list shows the current products that we recommend for new designs next to the corresponding previous-generation products.

u-blox cellular modules

Previous generation	Recommended for new designs
TOBY-L100	TOBY-L2 series
MPCI-L100	MPCI-L2 series
LISA-C200	SARA-R4 series
LEON-G1 series	SARA-G3 series, SARA-G450
SARA-N2 series	SARA-N3 series

For new cellular designs, please refer to the cellular module section starting on page 6.

u-blox short range modules

Previous generation	Recommended for new designs
OBS418, OBS419	NINA-B2
OBS421	ANNA-B1, NINA-B1, NINA-B2, NINA-B3, NINA-B4
ODIN-W1	EMMY-W1, JODY-W2
ELLA-W1	EMMY-W1, JODY-W2

For new short range designs, please refer to the short range module section starting on page 40.

u-blox positioning SiPs and modules

Previous generation	Recommended for new designs
EVA-7M	EVA-8M, EVA-M8M, EVA-M8Q
MAX-7C	MAX-8C, MAX-M8C
MAX-7Q	MAX-8Q, MAX-M8Q
MAX-7W	MAX-M8W
NEO-6M/6G, NEO-7M	NEO-8Q, NEO-M8M
NEO-6Q, NEO-7N	NEO-8Q, NEO-M8N, NEO-M9N
LEA-6S, 6A, 6H	LEA-M8S
LEA-6R, NEO-6V	Please contact u-blox
NEO/LEA-6T	NEO/LEA-M8T
NEO-6P, NEO-7P	NEO-M8P
PAM-7Q	SAM-M8Q

For new positioning designs, please refer to the position and time module section starting on page 86.

Services





Global online services

AssistNow™ global online service for accelerated positioning

u-blox provides globally accessible, highly-reliable internet-based online services for Assisted GNSS. AssistNow provides optional support to all u-blox satellite receivers worldwide with accurate satellite position aiding data to dramatically reduce Time-To-First-Fix, especially during cold start and weak signal conditions.

u-blox's AssistNow online service delivers global satellite position data 24/7.

CellLocate®: hybrid solution for indoor positioning

u-blox provides its CellLocate® online service free of charge to facilitate indoor positioning. The service capitalizes on hybrid GNSS/cellular positioning to provide a fix when satellite signals are weak or absent. CellLocate® supports u-blox's SARA-R5, SARA-R4, LARA-R3121, LARA-R2, TOBY-R2, SARA-U2, LISA-U2, SARA-G3, and SARA-G450 cellular modules.

u-blox's proprietary cellular/GNSS positioning service provides increased reliability and indoor positioning based on mobile network attributes.

Product software

Many of the u-blox products are preprogrammed with software that makes it easy for customers to interface with them in a standard way. The u-blox proprietary interface specifications for AT and UBX protocol ensures compatibility across form factors and technologies. Some products allow

customers to host their simple customer specific applications in the module allowing them to offload an external CPU and access the features through an application programming interface API. This enables customers to add even more value to the products.

Evaluation tools

u-blox's worldwide offices provide you with wireless and positioning technology experts to ensure the success of your designs. u-blox also gives you comprehensive interactive support software for evaluation, design-in, testing and performance visualization of all our wireless and positioning products. Based on a sophisticated graphical user interface, the u-center, m-center, and s-center PC software supports our GNSS and wireless modules and may be downloaded free-of-charge from our website. See the following pages for details.

Evaluation kits for u-blox's wireless and positioning products plus application boards are also available. Software tools for the evaluation, visualization and configuration of our cellular, Wi-Fi, Bluetooth® and positioning products can be downloaded from our website free-of-charge. For more information please visit our website at www.u-blox.com/support.

Evaluation kits and samples can be ordered via our online shop or via an authorized u-blox representative or sales office.

Visit our online shop at www.u-blox.com/online-shop.



EVK-N3 NB-IoT evaluation kit

Complete documentation

u-blox provides our customers with a complete set of technical documentation and firmware to support all u-blox products. These include:

- Data sheets
- Application notes
- System integration manuals
- Protocol specifications
- Module firmware, software, and USB device drivers
- Evaluation and integration software for Android
- Test reports

Our extensive archive of technical documents is available and searchable at our website, www.u-blox.com.



AssistNow

u-blox A-GNSS services

Fast Time-To-First-Fix, even under poor signal conditions

- End-to-end service for OEMs and end-users
- Global coverage and network operator independent
- Easy to install; no additional hardware required
- Seamless implementation with u-blox cellular modules that have an embedded AssistNow client
- Free of charge service
- Premium service with guaranteed QoS option
- Available for all u-blox GNSS products
- Low CPU load



The challenge of stand-alone GNSS

GNSS users expect instant position information. With standard positioning this is often not possible because at least four satellites must be identified, and their complete orbital position data (called Ephemeris) received. Under adverse signal conditions, data downloads from the satellites to the receiver can take minutes, hours or even fail altogether.

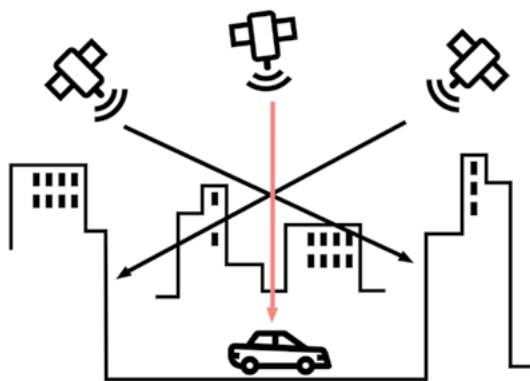

Assisted GNSS (A-GNSS) accelerates calculation of position by delivering satellite data such as Ephemeris, Almanac, accurate time and satellite status to the GNSS receiver via wireless networks or the internet. This aiding data enables a GNSS receiver to compute a position within seconds, even under poor signal conditions.

AssistNow A-GNSS service

AssistNow Online and AssistNow Offline are u-blox's end-to-end A-GNSS services for OEM customers and their end users. These services boost GNSS acquisition performance for devices with or without network connectivity. AssistNow Online and AssistNow Offline can either be used alone or in combination.

AssistNow A-GNSS services require no additional hardware and generate virtually no CPU load. The system is very easy to implement and can be installed and operational within a day. u-blox cellular modules feature an embedded AssistNow client making integration simple.

AssistNow Online

Supports GPS, Galileo, GLONASS, and BeiDou

With AssistNow Online, an internet-connected GNSS device downloads assistance data from u-blox's AssistNow Online Service at system start-up. The service works on all standard mobile communication networks that support internet access, including GPRS, UMTS and Wireless LAN. No special arrangements with mobile network operators are needed to enable AssistNow Online, making this solution network operator independent and globally available. u-blox only sends ephemeris data for those satellites currently visible to the mobile device requesting the data, thus minimizing the amount of data transferred.

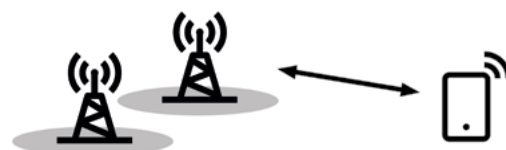



AssistNow Offline

Supports GPS and GLONASS

With AssistNow Offline, users download u-blox' Differential Almanac Correction Data from the internet at their convenience. The correction data is then transferred to the mobile terminal via TCP/IP, serial port, memory card, etc, and can either be stored in the GNSS receiver's Flash EPROM (if available) or in the memory of the application processor. Therefore, the service requires no connectivity at system start-up and enables a position fix within seconds, even when no network is available.

u-blox provides correction data valid from 1 to 35 days. The size of these files increases with the length of the prediction period, from as little as 3 kB to 125 kB. Positioning accuracy decreases with the length of the correction data duration, with 1–3 day data providing relatively high accuracy and 10–35 day data progressively less accuracy. Regular updates help to ensure a high level of position accuracy.

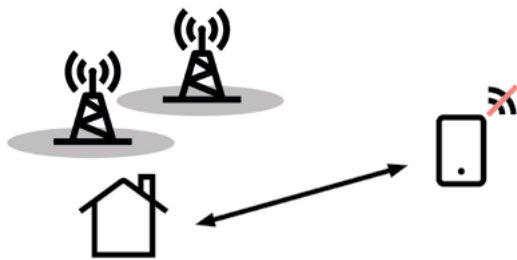

AssistNow Autonomous

Supports GPS, Galileo, GLONASS, and BeiDou

AssistNow Autonomous is an embedded feature available free-of-charge that accelerates GNSS positioning by capitalizing on the periodic nature of GNSS satellite orbits. GNSS orbit predictions are directly calculated by the GNSS receiver and no external aiding data or connectivity is required. AssistNow Autonomous can be used alone, or together with AssistNow Online or AssistNow Offline for increased positioning speed and accuracy.

Free and premium service options

AssistNow data is collected by u-blox's global array of satellite receivers, and maintained in real-time on u-blox AssistNow servers accessible via the internet. For best-effort applications, u-blox provides AssistNow free-of-charge to its customers.

For applications requiring a guaranteed minimum Quality of Service (QoS), u-blox provides AssistNow Premium which provides guaranteed availability based on a service level agreement and 24/7 support.

Products supporting AssistNow

- All u-blox GNSS receiver modules and chips
- SARA-G3 and SARA-G4 series 2G cellular modules
- SARA-U2 and LISA-U2 series 3G cellular modules
- SARA-R4/N4 series LTE Cat M1/NB1 cellular modules
- LARA-R2 and TOBY R2 series LTE Cat 1 cellular modules
- LARA-R3121 LTE Cat 1 cellular module

	AssistNow Online	AssistNow Offline	AssistNow Autonomous
Data			
Data download frequency	At every startup	Once every X days	Never
Data retrieval at start-up	Data downloaded from server	Pre-downloaded from local memory	Retrieved from local memory
Aiding data type	Ephemeris, almanac, time, health	Differential almanac correction	Automatically generated
Data validity period	2 - 4 hours	35 days	Up to 6 days
Size of downloaded data	1 - 3 kB	10 kB (1 day) ... 125 kB (35 days)	N.A.
Acquisition (TTFF) performance	As low as 1 second	As low as 5 seconds	As low as 10 seconds
GNSS			
Satellite systems supported	GPS, Galileo, GLONASS, BeiDou	GPS, GLONASS	GPS, Galileo, GLONASS, BeiDou
Service options			
Free service	Best-effort	Best effort	N.A.
Premium service	Guaranteed availability based on service level agreement	Guaranteed availability based on service level agreement	N.A.



CellLocate®

Mobile network-based positioning

Position available even in areas of poor or no GNSS

- Network operator independent
- Supported by u-blox GSM/GPRS, HSPA/UMTS, LTE Cat 1, LTE-M, and NB-IoT modules
- Easy to integrate into end applications
- No additional hardware required
- Free best-effort service



Increased reliability and indoor positioning based on mobile network information

Although it is a widespread and very effective technology, Global Navigation Satellite System (GNSS) positioning is not always possible, particularly in challenging signal environments such as urban canyons, indoors, in enclosed park houses, or when GNSS jamming signals are present. Performance can be improved by complementing the GNSS receiver data with information from mobile network cells that can benefit numerous applications.

u-blox, through its in-house development of cellular data modules and GNSS receivers, has developed and embedded a cellular positioning technology, CellLocate®, into its GSM/GPRS, HSPA/UMTS, and LTE cellular modules. This technology enables stand-alone location estimation based on surrounding mobile network information in conjunction with GNSS positioning data to improve positioning.

For any given location with cellular network coverage (2G, 3G or 4G), a specific combination of network cells will be visible. The proprietary CellLocate feature allows u-blox cellular modules to report to the CellLocate server those cells which are visible at any specific location. This enables the server to estimate a coarse position on the basis of previous observations from other modules reporting the same cell visibility pattern, and this position is reported back to the module. The estimated position is then output by the module to the host processor via its serial port.

Cellular location

Network cells are widely available in urban and rural environments enabling the CellLocate service to provide a position estimate virtually everywhere and under any conditions.

The service is offered free of charge on a best effort basis and the performance depends on the density of network cells and database population. A self learning mechanism is implemented allowing continuous database improvement and update in order to increase performance over time and prevent database aging.

CellLocate® and hybrid positioning

CellLocate and hybrid positioning are u-blox's end-to-end services for OEM customers and their end-users. These services enhance and complement stand-alone GNSS acquisition performance when u-blox cellular modules and GNSS modules or chips are used.

u-blox implementation provides a single AT command interface enabling full control of the GNSS receiver and cellular positioning functionality in order to maximize performance and virtually eliminate any "no position scenario". Through the single AT command interface it is possible to define all the positioning settings (cellular, stand-alone GNSS, GNSS aiding data) and enable the cellular module to optimize positioning performance. CellLocate and hybrid services are fully integrated into u-blox cellular modules and work in parallel to normal module functionality.

While stand-alone CellLocate is able to estimate position even when the GNSS signal is completely absent, hybrid positioning technology provides even better performance by using a combination of complementary positioning methods.





Features / details

Supported network technologies	GSM/GPRS UMTS/HSPA 1xRTT W-CDMA LTE/E-UTRA
GNSS aiding settings	Stand-alone, AssistNow Online/Offline/Autonomous
Data size ¹	Uplink: 100 – 200 bytes Downlink (position only): 150 bytes Downlink (including GNSS aiding data): 1 – 3 kB

1: Data size depends on the number of visible cells and user selected GNSS aiding data

CellLocate enabled products

SARA-R5 series multi-band LTE-M / NB-IoT cellular modules
SARA-R4 series LTE-M / NB-IoT / EGPRS cellular modules
LARA-R2 series LTE Cat 1 cellular modules
TOBY-R2 series LTE Cat 1 cellular modules
LARA-R3121 LTE Cat 1 cellular module
SARA-U2 series UMTS/HSPA cellular modules
LISA-U2 series UMTS/HSPA cellular modules
SARA-G4 series GSM/GPRS cellular modules
SARA-G3 series GSM/GPRS cellular modules

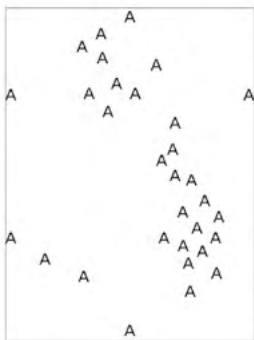

CellLocate database contains historic observations of cell A reported by several devices

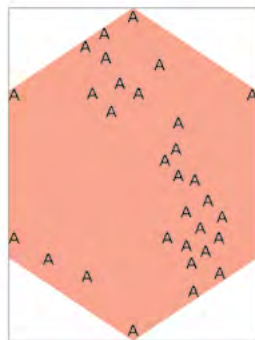

CellLocate server defines area of cell visibility

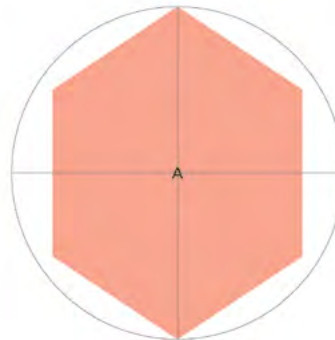

New device observes cell A, position is estimated from the previous observations

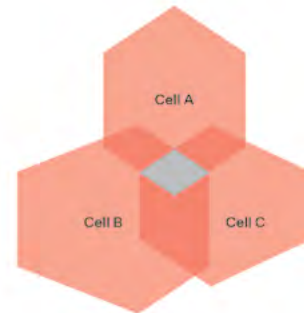

Visibility of multiple cells provides even better coverage and accuracy

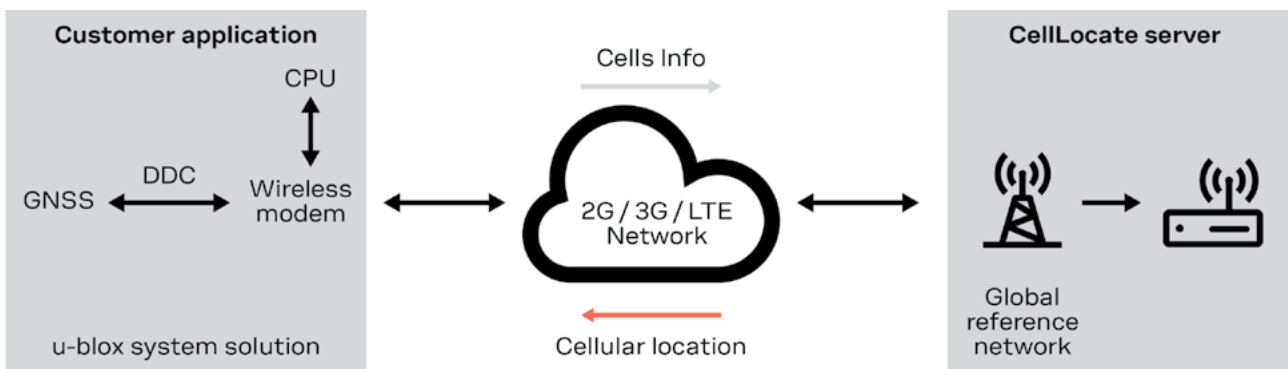

Evaluation tools and software





Application boards

Design tools for u-blox wireless and positioning products

Application boards and explorer kits are complete, integrated u-blox solutions.



Positioning solutions:

- **C099-F9P** – application board with ZED-F9P module for u-blox multi-band RTK solutions
- **C100-F9K** – application board with ZED-F9K module for u-blox multi-band RTK solutions
- **C94-M8P** – application board with NEO-M8P module for u-blox single-band RTK solutions
- **C93-M8E** – UDR application example with EVA-M8E SiP

Internet of Things solutions:

- **C030** – LTE Cat 1, Cat M1, NB-IoT and 2G/3G Mbed-enabled IoT starter kit
- **C027** – 2G/3G Mbed-enabled Internet of Things starter kit for rapid prototyping

Explorer kits:

- **XPLR-M9** – explorer kit for UBX-M9140 and NEO-M9N
- **XPLR-LARA-R3** – explorer kit for LTE Cat 1 with the LARA-R3121 module
- **XPLR-NINA-B31** – explorer kit for NINA-B31

Blueprints provide a reference design of one or more products.



Bluetooth solutions, small battery-powered reference designs:

- **B200 blueprint** for NINA-B1 series Bluetooth low energy modules with BMI160 sensor
- **B201 blueprint** for NINA-B1 Bluetooth low energy and EVA-M8 GNSS modules
- **B203 blueprint** for JODY-W1 series multiradio modules
- **B204 blueprint** for NINA-B1 series Bluetooth low energy modules with USB connector

Gateway solution:

- **B31 Gateway blueprint** demonstrates the integration of all u-blox technologies (Cellular, GNSS and Short Range) in a single board with integrated antennas

Upon request to regional sales channels, u-blox provides reference designs and blueprints dedicated to specific applications.



Evaluation kits and tools

For simple evaluation of u-blox wireless and positioning products

GNSS Position & Time evaluation kits



GNSS chips & SiPs and modules with TCXO:

- EVK-M91 supports UBX-M9140 and NEO-M9N
- EVK-M8230 supports UBX-M8230-CT
- EVK-M8GZOE supports ZOE-M8G and ZOE-M8Q
- EVK-M8BZOE supports low-power ZOE-M8B
- EVK-M8N supports UBX-M8030 chips with TCXO, MAX-M8Q, MAX-M8W, NEO-M8N, NEO-M8Q, LEA-M8S
- EVK-8N supports UBX-G8020 chips, MAX-8Q, NEO-8Q
- EVK-M8QEVA supports EVA-M8Q

GNSS chips & SiPs and modules with crystal:

- EVK-M8C supports UBX-M8030 chips with crystal, MAX-M8C, NEO-M8M, MAX-8C
- EVK-M8MEVA supports EVA-M8M, EVA-8M

GNSS antenna modules:

- EVK-M8CCAM supports CAM-M8C and EVK-M8QCAM supports CAM-M8Q
- EVK-M8QSAM supports SAM-M8Q

GNSS chips & modules with dead reckoning:

- EVK-M8L supports ADR module NEO-M8L
- EVK-M8U supports UDR module NEO-M8U and EVA-M8E

GNSS modules with precision timing:

- EVK-M8F supports LEA-M8F
- EVK-M8T supports LEA-M8T, NEO-M8T

Short range wireless evaluation kits



Bluetooth BR/EDR and Bluetooth low energy kits:

- EVK-ANNA-B112
- EVK-NINA-B1
- EVK-NINA-B2
- EVK-NINA-B3
- EVK-NINA-B4
- EVK-BMD-34/38
- EVK-BMD-330
- EVK-BMD-360
- EVK-BMD-30/35
- EVK-R41Z

Wi-Fi kits:

- EVK-NINA-W13
- EVK-LILY-W1

Multiradio kits:

- EVK-ODIN-W2
- EVK-W262U
- EVK-NINA-W10
- EVK-NINA-W15
- EVK-ELLA-W1
- EVK-EMMY-W1
- EVK-JODY-W163
- EVK-JODY-W164

V2X evaluation kit:

- EVK-VERA-P174 supports VERA-P1 module series



Cellular evaluation kits and adapter boards



LTE and NB-IoT evaluation kits:

- EVK-R2 supports LTE Cat 1 (TOBY-R2 and LARA-R2 module series)
- EVK-R4 supports LTE-M (SARA-R4 module series)
- EVK-R5 supports LTE-M (SARA-R5 module series)
- EVK-N3 supports NB-IoT (SARA-N3 module series)
- EVK-L2 supports LTE Cat 4 (TOBY-L2 module series)
- EVK-L4 supports LTE Cat 6 (TOBY-L4 module series)

GSM/GPRS and UMTS/HSPA evaluation kits:

- EVK-G35 supports 2G (SARA-G3 module series)
- EVK-G45 supports 2G (SARA-G450 module)
- EVK-U20/U23 support 3G (LISA-U2 module series)
- EVK-U26/U27 support 3G (SARA-U2 module series)

Cellular adapter boards (product supported):

- ADP-R200 (TOBY-R200)
ADP-R202 (TOBY-R202)
ADP-R203 (LARA-R203)
ADP-R204 (LARA-R204)
- ADP-R211 (LARA-R211)
ADP-R220 (LARA-R220)
ADP-R280 (LARA-R280)
- ADP-R404M (SARA-R404M)
ADP-R410M (SARA-R410M)
ADP-R412M (SARA-R412M)
ADP-R422 (SARA-R422)
ADP-R422M8S (SARA-R422M8S)
- ADP-R510S (SARA-R510S)
ADP-R510M8S (SARA-R510M8S)
- ADP-N300 (SARA-N300)
ADP-N310 (SARA-N310)
- ADP-L200 (TOBY-L200)
ADP-L201 (TOBY-L201)
ADP-L210 (TOBY-L210)
ADP-L220 (TOBY-L220)
ADP-L280 (TOBY-L280)
- ADP-L4006 (TOBY-L4006)
ADP-L4106 (TOBY-L4106)
ADP-L4206 (TOBY-L4206)
ADP-L4906 (TOBY-L4906)
- ADP-G350 (SARA-G350)
ADP-G450 (SARA-G450)
- ADP-U200 (LISA-U200)
ADP-U230 (LISA-U230)
ADP-U260 (SARA-U260)
ADP-U270 (SARA-U270)

Evaluation kits, application boards, explorer kits, and blueprints, for current as well as previous generation products, can be ordered via the [u-blox online shop](#).



u-center

GNSS evaluation software

Highlights

- Interactive and easy to use
- Extensive GNSS configuration, control features, and output messages
- Supports all u-blox GNSS receivers
- Enables comparative performance analysis of GNSS receivers that output NMEA messages
- Free of charge

Product description

The u-center GNSS Evaluation Software provides a powerful platform for product evaluation, configuration, testing and realtime performance visualization of u-blox GNSS receiver products. u-center provides AssistNow client functionality for A-GNSS. Its unique flexibility makes u-center the ideal tool through the entire system integration process.

u-center includes

Support for NMEA and u-blox UBX binary protocol

Integrated AssistNow A-GNSS client functionality

Structured and graphical data visualization in realtime:

- Satellite summary view
- Navigation summary view
- Compass, speedometer, clock, altimeter
- Chart view of any two parameters of choice
- Data recording and playback functionality

Docking views (real-time cockpit instruments): Satellite constellation, compass, clock, altimeter, speedometer, GNSS and satellite information views

Full cut-and-paste functionality to transfer information to standard PC application software

Firmware update feature for u-blox receivers

RTCM protocol and NTRIP support

Map views, Google Earth server support, deviation map

Text consoles, statistics, and more

Configuration and control options

u-center provides a convenient means to configure the GNSS receiver, to save customized configuration settings in the GNSS receiver flash memory and to restore factory settings if needed. Toolbar buttons are available to control settings such as to force cold, warm and hot starts.

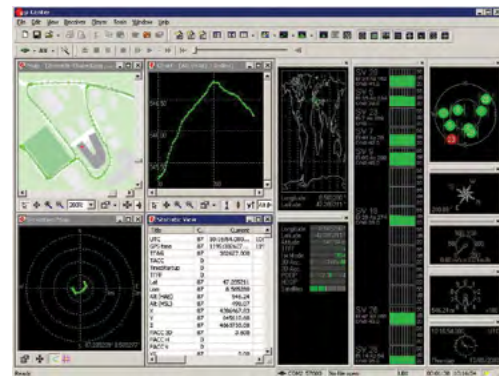

Visualization

Docking views with real-time cockpit instruments and satellite status charts allow easy observation of the static and dynamic behavior of the GNSS receiver.

To visualize positions and traveled routes on maps, easy-to-use interactive functions are provided that enable importing a map file and entering three geodetic positions in order to calibrate the map so the measured positions are placed correctly on the map.

Data analysis

u-center allows the user to choose from a large number of parameters to create tabular views, 2D charts, histograms and compute statistics. Tabular views can be copied and inserted into commercial software like Microsoft Excel spreadsheets.

Operating systems

u-center supports PCs running Windows Vista and later Windows releases (x86 and x64).

Ordering information

u-center is available free of charge and can be downloaded from our website.



Android GNSS solution

Evaluation & integration software for Android positioning

Highlights

- Allows easy integration of GNSS functionality in Android-based products
- Royalty-free GNSS driver, licensed for reuse in customer products
- Fully compliant with Android Compatibility Definition Document (CDD)



Solution description

u-blox's GNSS Android solution enables customers to easily integrate and evaluate GNSS functionality in their Android-based end products. The solution includes A-GNSS capabilities for high performance GNSS as well as terminal and network based positioning on mobile operator networks.

The royalty-free u-blox Android GNSS driver is licensed for reuse in customer products and available upon request.

u-blox Android solution includes

Android GNSS driver

Documentation explaining the implementation

Solution characteristics

u-blox Android	GNSS driver v18.11
	Supports Android versions 7.0, 8.x, and 9.0

Supported Products

The Android GNSS solution supports all u-blox 5, u-blox 6, u-blox 7, u-blox 8, u-blox M8, and u-blox 9 GNSS receivers with USB/UART, DDC, or SPI connections.

Ordering information

For further details and to obtain the u-blox Android GNSS driver, please contact the u-blox sales representative nearest you.



m-center

Cellular evaluation software for Windows

Highlights

- Interactive, simple evaluation of u-blox cellular modules
- Access to main functionality and configuration parameters
- Learn AT commands using the GUI interfaces thanks to embedded AT terminal
- Trace GSM/GPRS/UMTS/LTE module activity
- PIN, call, and SMS management
- Communication with u-blox GNSS modules
- Free of charge

Product description

The m-center cellular evaluation software is a powerful and easy to use tool for evaluating, configuring, and testing of u-blox cellular modules. It includes an intuitive, easy to understand and easy to use graphical interface. m-center is available free-of-charge.

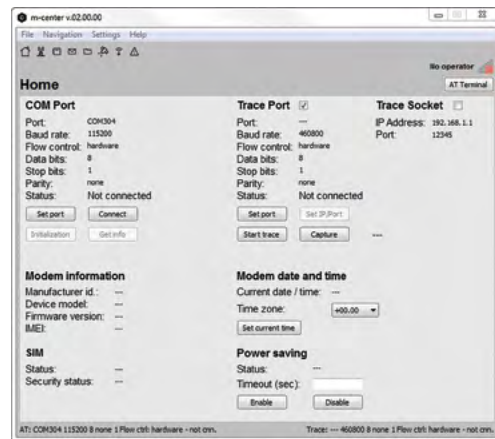

m-center includes

AT command terminal with user defined commands
PIN management
Call management
SMS management
GPRS context configuration
Communication with u-blox GNSS modules
Intelligent driver detection
Firmware download Over The Air (FOTA)
eCall PSAP simulator

Configuration and control options

m-center provides a convenient means to configure u-blox cellular modules and save the configuration in the module EPROM. It is also possible to view and edit SIM phonebook entries, send text messages, and communicate with the cellular module using AT commands.

m-center can be used to restore the cellular module's factory-programmed settings and to perform traces. In addition, when using u-blox cellular evaluation kits, m-center allows for simple communication with the onboard GNSS module.

m-center implements an eCall Public Safety Answering Point simulator; using it, customers can easily test their own eCall applications.

Visualization

The very simple graphical user interface allows the user to perform common GSM/GPRS/UMTS/LTE tasks and the embedded AT terminal shows all the AT commands trace in order to decrease the learning curve of the AT commands set. All the AT terminal activity can be saved to a text file.

Enabling the trace feature allows users to save internal GSM/GPRS/UMTS/LTE module activity to facilitate sending of binary data to u-blox customer support.

Operating systems

m-center supports PCs running Windows Vista onwards (x86 and x64)

Ordering information

m-center is available free of charge and can be downloaded from our website.

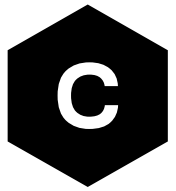

RIL software for cellular modules

Radio interface layer for u-blox cellular modems

Highlights

- Quick and easy integration of u-blox cellular modules into Android-based designs
- Free of charge for u-blox customers

Features

- Complete source-code of RIL library
- PC-based simulator
- Comprehensive documentation explaining implementation

Product description

u-blox RIL (“Radio Interface Layer”) software allows easy integration of u-blox cellular modules into Android based designs.

The software is available free of charge for u-blox customers.

The solution includes:

PC-based simulator

This simulator enables quick evaluation of u-blox RIL software. The simulator is a stand-alone tool that can be installed on a PC running Windows 10 or 7. An evaluation kit can be connected to the PC and customers can run an application on the simulator.

RIL libraries

This is the source code of u-blox RIL libraries. The source code can be integrated into an Android environment.

Supported operating systems

- Android 10.x, 9.x, 8.x, 7.x, 6.x, 5.x, 4.4.x, 4.2.x

Supported cellular modules

- SARA-G4 series
- SARA-G3 series
- SARA-U2 series
- LISA-U2 series
- SARA-R5 series
- SARA-R4 series
- LARA-R2 series
- TOBY-R2 series
- TOBY-L2 series
- TOBY-L4 slim modem series

For more details, contact the u-blox sales representative nearest you.

Cellular device

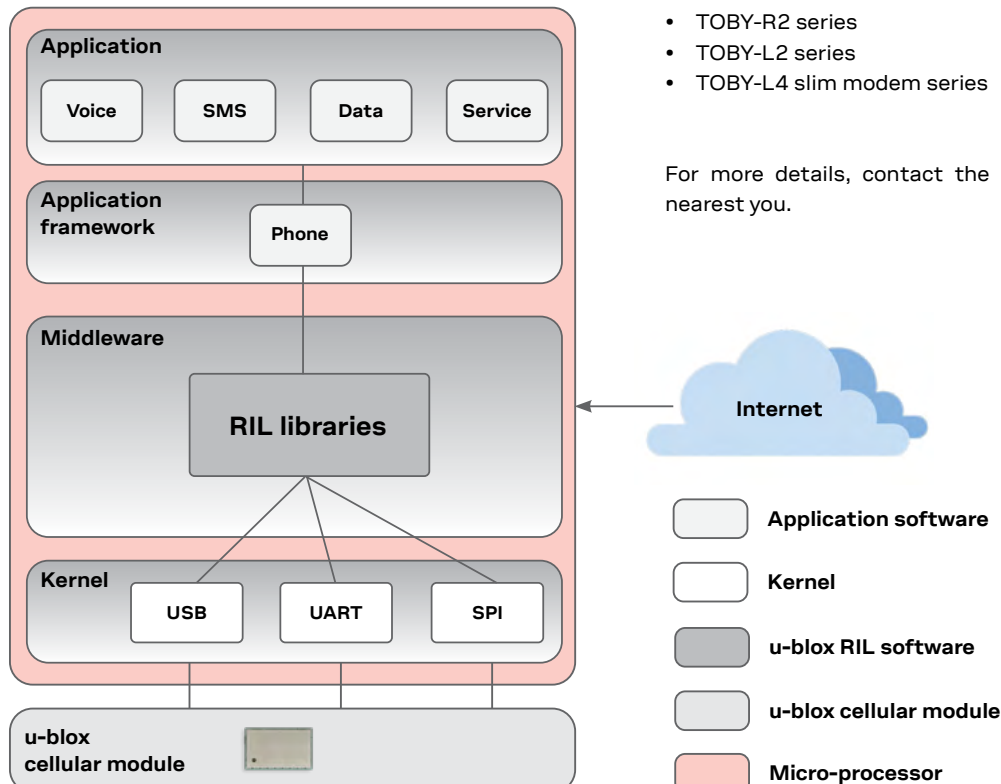

s-center

Wi-Fi and Bluetooth module evaluation software

Highlights

- Interactive and easy to use
- Integrated performance measurements
- Support for Wi-Fi, Bluetooth BR/EDR and Bluetooth low energy
- Free download from u-blox website
- Enables storing current configuration as a text file and supports downloading of this configuration file

Product description

The s-center software is a powerful and easy-to-use tool for evaluating, configuring, and testing u-blox short range modules. It includes an intuitive, easy-to-understand and easy-to-use graphical interface.

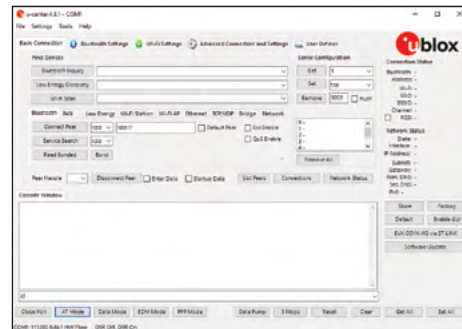

s-center includes

AT command terminal with user defined commands
 Support for UART, MQTT, TCP client and TCP server interface
 Firmware update feature for u-blox short range modules
 Chat tool
 TCP reflector
 Data pump

Configuration and control options

s-center provides a convenient means to configure the u-blox short range modules, to save the configuration in the flash memory of the module, and to restore factory settings if needed. Toolbar buttons are available to control settings. Each command that is executed by s-center is an AT command that is described in the Short Range Modules AT Command Manual.

Data analysis

s-center has built in tools for throughput measurements and data validation using COM ports as well as TCP server and client. It can also be used to send packets with different sizes and intervals to emulate a specific use case.

Visualization

The very simple graphical user interface allows the user to configure Wi-Fi, Bluetooth BR/EDR and Bluetooth low energy modules. The embedded AT command terminal shows all the AT commands used. The current configuration can be saved to a text file for analysis or backup. The file with current configuration can also be used to copy the configuration to multiple devices using the download configuration file option.

Operating systems

s-center supports PCs running Windows XP onwards (x86 and x64) with .Net Framework 4.5 or later.

Ordering information

s-center is available free of charge and can be downloaded from our website.

Bluetooth iOS and Android App

Bluetooth low energy demo application

Highlights

- Supports u-blox modules NINA-B1, NINA-B2, NINA-B3, NINA-B4, NINA-W15, and ODIN-W2
- Powerful Bluetooth low energy evaluation and visualization app
- Source code available on github – <https://github.com/u-blox>
- Free of charge

Operating systems supported

- Android 4.3 or later
- iOS 7.1 or later

Product description

The u-blox Bluetooth Smart application allows developers to evaluate Bluetooth low energy via the u-blox modules NINA-B1, NINA-B2, NINA-B3, NINA-B4, NINA-W15, and ODIN-W2. In NINA-B1, the application can also be used with the B200 blueprint design to read and control 3-axis accelerometer, temperature sensor, battery level sensor, and LEDs.

Visit any of the supported product webpages on www.u-blox.com. There you can find links to the iOS and Android apps in the "Documentation & resources" section. The links are listed under the Design Resources category.

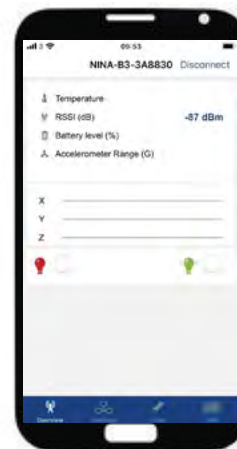

CONTACTS

Europe, Middle East, Africa

Headquarters

u-blox AG, Switzerland

Phone: +41 44 722 74 44
Fax: +41 44 722 74 47
E-mail: info@u-blox.com
Support: support@u-blox.com

Corporate Address

u-blox AG
Zürcherstrasse 68
8800 Thalwil
Switzerland

Americas

North and South America

u-blox America, Inc., Reston, VA

Phone: +1 (703) 483 3180
E-mail: info_us@u-blox.com
Support: support_us@u-blox.com

Asia-Pacific

Singapore

u-blox Singapore Pte. Ltd.

Phone: +65 6734 3811
E-mail: info_ap@u-blox.com
Support: support_ap@u-blox.com

Australia

u-blox Singapore Pte. Ltd.

Phone: +61 (0)2 8448 2016
E-mail: info_anz@u-blox.com
Support: support_ap@u-blox.com

China

u-blox Beijing Rep. Office

Phone: +86 10 68 133 545
E-mail: info_cn@u-blox.com
Support: support_cn@u-blox.com

China

u-blox Shenzhen Rep. Office

Phone: +86 755 8627 1083
E-mail: info_cn@u-blox.com
Support: support_cn@u-blox.com

China

u-blox Shanghai Rep. Office

Phone: +86 21 6090 4832
E-mail: info_cn@u-blox.com
Support: support_cn@u-blox.com

China

u-blox Chongqing Rep. Office

Phone: +86 23 6815 1588
E-mail: info_cn@u-blox.com
Support: support_cn@u-blox.com

Japan

u-blox Japan KK, Osaka

Phone: +81 6 6941 3660
E-mail: info_jp@u-blox.com
Support: support_jp@u-blox.com

Japan

u-blox Japan KK, Tokyo

Phone: +81 3 5775 3850
E-mail: info_jp@u-blox.com
Support: support_jp@u-blox.com

India

u-blox Singapore Pte. Ltd., Bengaluru

Phone: +91 99 4532 9985
E-mail: info_in@u-blox.com
Support: support_in@u-blox.com

Korea

u-blox Korea Branch Office, Seoul

Phone: +82 2 542 0861
E-mail: info_kr@u-blox.com
Support: support_kr@u-blox.com

Taiwan

u-blox Taiwan Rep. Office, Taipei

Phone: +886 2 2657 1090
E-mail: info_tw@u-blox.com
Support: support_tw@u-blox.com

WORLDWIDE PRESENCE

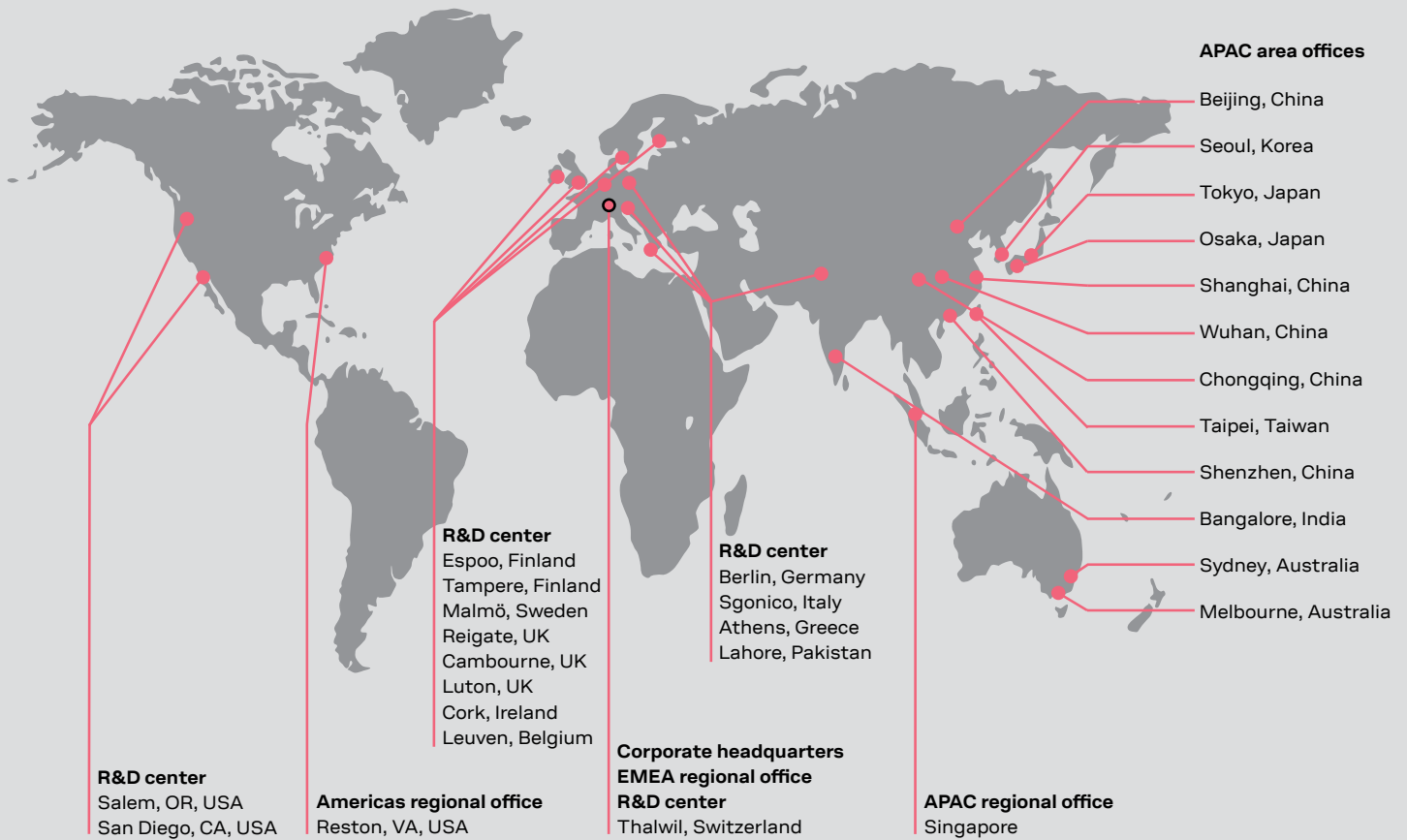

Disclaimer

u-blox reserves all rights to this document and the information contained herein. Products, names, logos and designs described may in whole or in part be subject to intellectual property rights. Reproduction or modification of this document or any part thereof without the express permission of u-blox is strictly prohibited.

Data shown in this document are estimates only and do not constitute any warranty or guarantee of product performance or services. No warranty or guarantee of any kind, either express or implied, is made in relation to the accuracy, the reliability or the fitness for a particular purpose of a product or the content of this document. This document may be revised by u-blox at any time. For most recent documents, please visit: www.u-blox.com.

u-blox®, CellLocate® and AssistNow™ are trademarks of u-blox Holding AG or u-blox AG registered and/or used in the EU, USA and other countries.

ARM® and mbed™ are trademarks of ARM Limited used in the EU and other countries.



Mouser Electronics

Authorized Distributor

Click to View Pricing, Inventory, Delivery & Lifecycle Information:

[u-blox:](#)

[EVK-NINA-B306](#) [EVK-NINA-B316](#) [EVK-NINA-B301](#) [EVK-NINA-B302](#) [EVK-NINA-B311](#) [EVK-NINA-B312](#) [ADP-L200](#)
[ADP-L210](#) [ADP-L220](#) [ADP-L280](#) [ADP-N300](#) [ADP-R200](#) [ADP-R203](#) [ADP-U200](#) [ADP-U230](#)