



The Future of Analog IC Technology®

EV23701-QEU-00A

High-Efficiency, Synchronous Step-Down LED Driver Evaluation Board

DESCRIPTION

The EV23701-QEU-00A Evaluation Board is designed to demonstrate the capabilities of MP23701. The MP23701 is a 24V monolithic synchronous step-down LED driver with a built-in power MOSFET and rectifier. It achieves up to 2A continue output current with excellent load and line regulation in a tiny UTQFN8(1.5mm*2.5mm) package. Peak current mode operation provides fast transient response and eases loop stabilization.

The EV23701-QEU-00A is typically designed for driving 1-2 WLEDs in series LED load with 1A LED current at wide 4.2V to 24V input range.

The EV23701-QEU-00A has high performances in efficiency, line/load regulation and deep analog dimming. Fault condition protection includes cycle-by-cycle peak current limiting, output short circuit protection, open LED protection, NTC thermal protection and thermal shutdown.

ELECTRICAL SPECIFICATION

Parameter	Symbol	Value	Units
Input Voltage	V_{IN}	4.2 to 24	V
Output Voltage	V_{OUT}	3-6	V
LED Current	I_{LED}	1	A

FEATURES

- 4.2V to 24V Wide Input Range
- Synchronous Step-Down Converter
- 100mΩ Internal High-side Power MOSFET
- 80mΩ Internal Low-side Synchronous Rectifier
- Peak Current Mode Control
- 1A Continue Output Current
- 100mV Feedback Voltage
- Up to 95% Efficiency
- Fixed 1.5MHz Switching Frequency
- Analog Dimming
- Cycle-by-Cycle Current Limit
- Inherent LED Open Protection
- Output Short Circuit Protection
- NTC Thermal Protection
- Thermal Shutdown
- Auto-Restart Function

APPLICATIONS

- Infrared LED Driver
- General LED Driver
- Flashlight
- Handheld Computers Backlight

All MPS parts are lead-free, halogen free, and adhere to the RoHS directive. For MPS green status, please visit MPS website under Quality Assurance.

"MPS" and "The Future of Analog IC Technology" are Registered Trademarks of Monolithic Power Systems, Inc.

EV23701-QEU-00A EVALUATION BOARD



(L x W) 50mm x 50mm	
Board Number	MPS IC Number
EV23701-QEU-00A	MP23701GQEU

Efficiency vs. V_{IN}

$V_{IN}=12V, T_A = 25^\circ C$

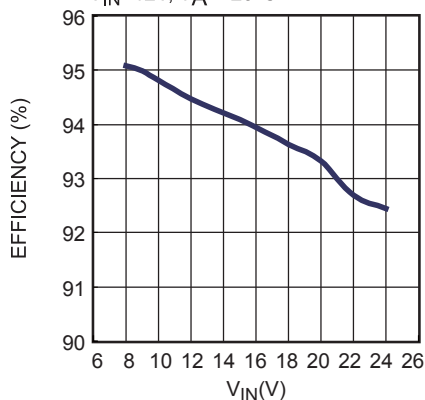

EVALUATION BOARD SCHEMATIC

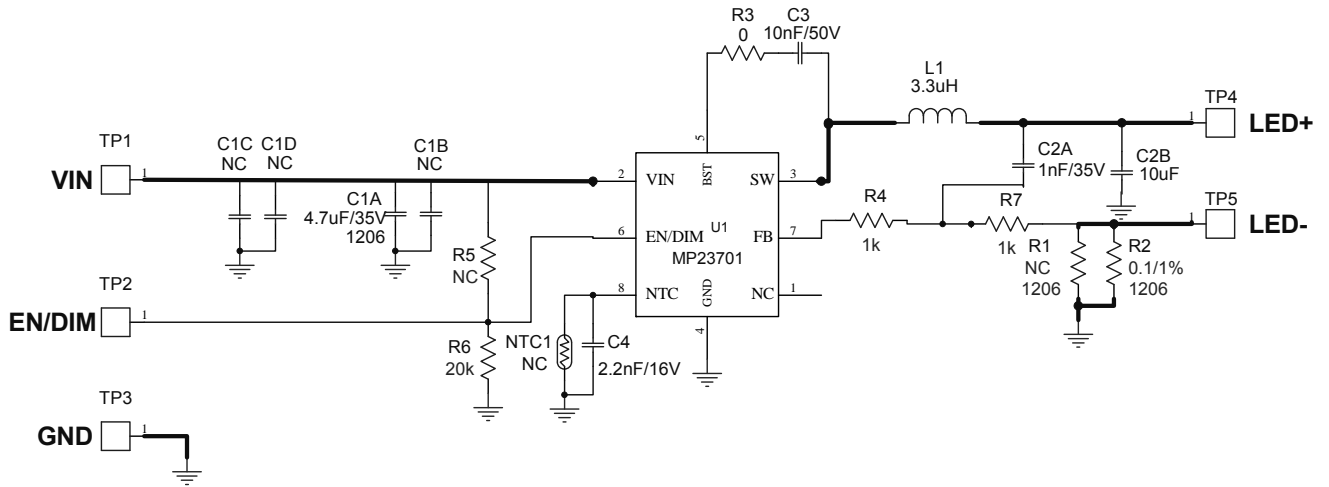

Figure 1 - Schematic

EV2410-JE-00A BILL OF MATERIALS

Qty	Ref	Value	Description	Package	Manufacturer	Manufacturer_P/N
1	C1A	4.7 μ F/35V	Ceramic Cap, 35V, X7R	1206	Taiyo Yuden	GMK316A7475KL-T
4	C1B,C1C C1D,	NC				
1	C2A	1nF/50V	Ceramic Cap, 50V, X7R	0603	muRata	GRM033R71H102KA12D
1	C2B	10 μ F/35V	Ceramic Cap, 35V, X7R	1210	muRata	GRM32ER7YA106KA12L
1	C3	10nF/50V	Ceramic Cap, 50V, X7R	0603	muRata	GRM188R71H103KA01D
1	C4	2.2nF/16V	Ceramic Cap, 16V, X7R	0603	muRata	GRM188R71C222KA01D
1	L1	3.3 μ H	Inductor, 3.3 μ H, 4.4A	SMD	TDK	RLF7030-3R3M4R1(非标)
1	NTC1	NC				
1	R1	100m Ω	Thick Film Chip RES, 1%	1206	CYNTEC	RL1632H-R100-FN
1	R2	NC				
1	R3	0 Ω	Thick Film Chip RES, 1%	0603	Yageo	RC0603FR-070RL
2	R4,R7	1k Ω	Thick Film Chip RES, 1%	0603	Yageo	RC0603FR-071KL
1	R5	NC				
1	R6	20k Ω	Thick Film Chip RES, 1%	0603	Yageo	RC0603FR-0720KL
1	U1	MP23701	Sync Step-down LED Driver	UTQFN8	MPS	MP23701GQEU-Z

EVB TEST RESULTS

Performance waveforms are tested on the evaluation board.

$V_{IN} = 12V$, 2 WLEDs in series, $V_{OUT} = 6V$, $I_{LED} = 1A$, $L = 3.3\mu H$, $T_A = 25^\circ C$, unless otherwise noted.

Steady State

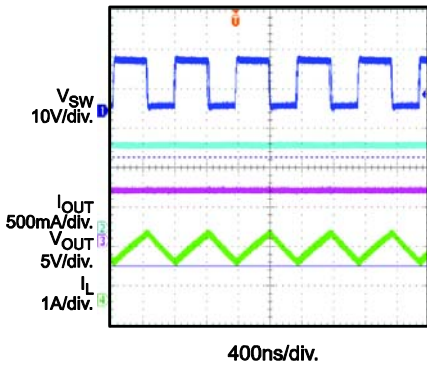

V_{IN} Start-Up

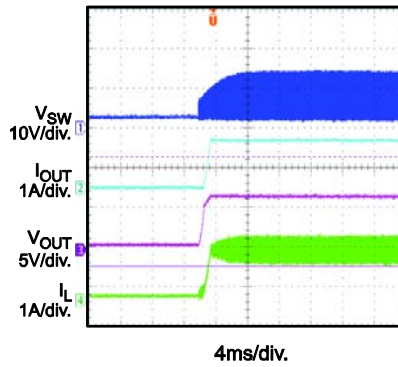

EN Start-Up

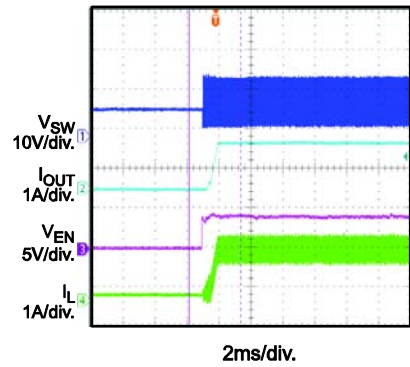

EN Shutdown

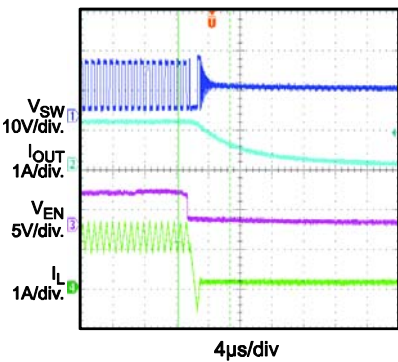

Analog Dimming

$V_{IN}=5V$, 1WLED, $V_{OUT}=3V$,
 $I_{LED}=1A$, $V_{DIM}=1V$

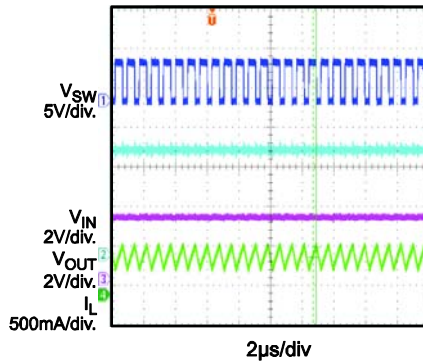

PWM Dimming

$V_{IN}=5V$, 1WLED, $V_{OUT}=3V$,
 $I_{LED}=1A$, 200Hz/D=50%

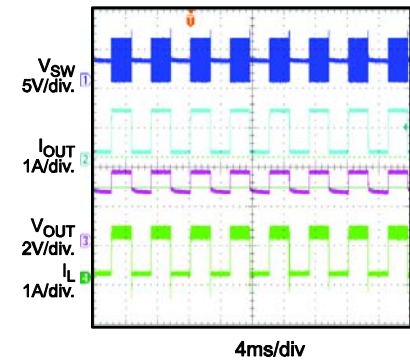

Open LED Protection

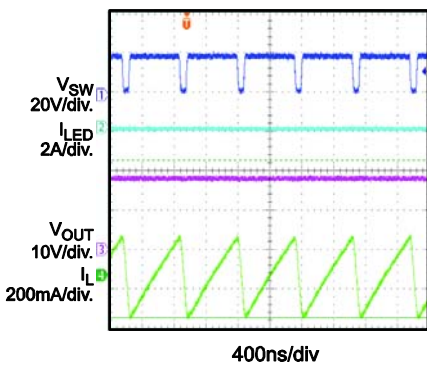

Short LED+ to LED- Protection

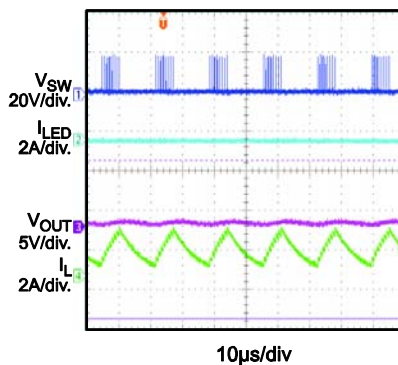

Short LED+ to GND Protection

$V_{IN}=5V$, 1WLED, $V_{OUT}=3V$, $I_{LED}=1A$

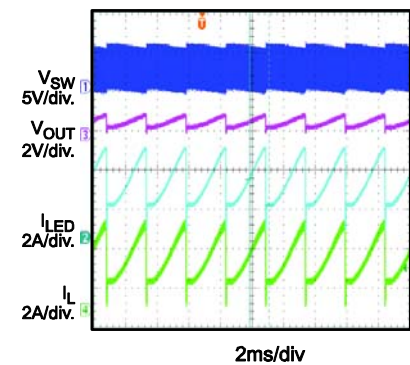

PRINTED CIRCUIT BOARD LAYOUT (DOUBLE-SIDED)

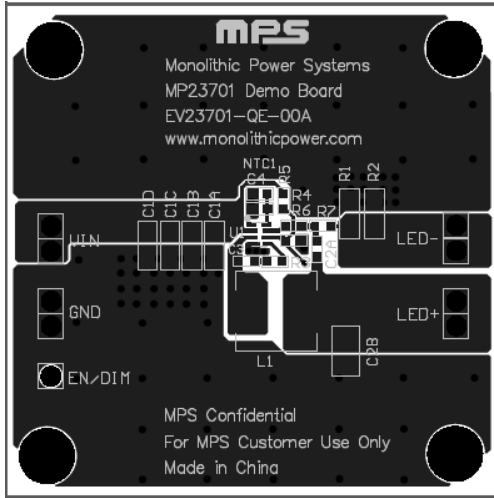

Figure 2 - Top Layer

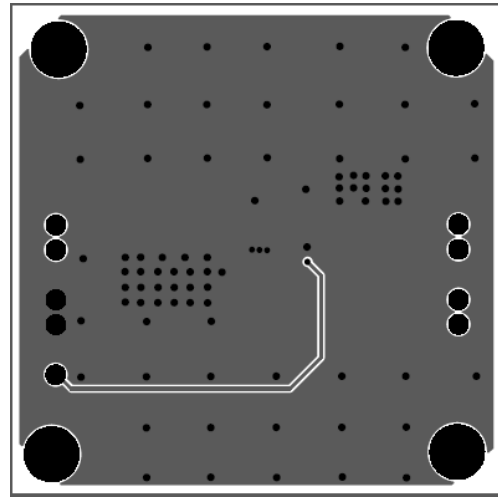

Figure 3 - Bottom Layer

QUICK START GUIDE

1. Preset DC Power Supply output to 4.2V to 24V and turn off Power Supply.
2. Connect the positive terminal of Power Supply output to the VIN pin and the negative terminal to the GND pin.
3. Connect the LED load between “LED+” (anode of LED string) and “LED-”(cathode of LED string).
4. Turn on Power Supply.
5. Apply the Enable voltage to the EN/DIM pin and drive Enable high to turn on the chip. When Enable voltage is less than 0.3V, the chip is turned off.
6. To apply analog dimming, a variable DC signal (0.6V to 1.5V) is required. Connect the positive and negative terminals of DC signal to the EN/DIM and GND pins, respectively. By adjusting the voltage level from 0.6V to 1.5V, the LED current changes from the min scale to full scale of the maximum LED current. If the dimming voltage is higher than 1.5V, the maximum LED current is generated.
7. Tie a NTC resistor to NTC pin to adjust V_{NTC} to implement thermal protection.
8. C1B, C1C, C1D are as option to improve EMI performance, the 10nF or 22nF low ESR ceramic cap is recommended to filter the noise.

NOTICE: The information in this document is subject to change without notice. Please contact MPS for current specifications. Users should warrant and guarantee that third party Intellectual Property rights are not infringed upon when integrating MPS products into any application. MPS will not assume any legal responsibility for any said applications.

Mouser Electronics

Authorized Distributor

Click to View Pricing, Inventory, Delivery & Lifecycle Information:

[Monolithic Power Systems \(MPS\):](#)

[EV23701-GEU-00A](#) [EV23701-QEU-00A](#)