

Dupline® Carpark Software, Server and Client Types DUP-PGS-SWxxxxx

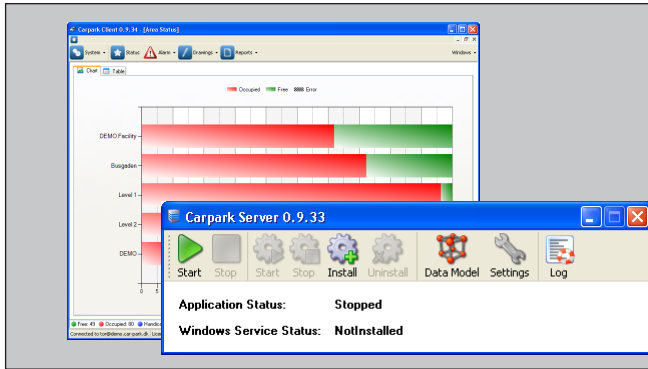

- Server software for control and handling of the Carpark facility, data logging and remote management
- Client software for control and monitoring of the Carpark facility, data management, booking of places
- Runs on Windows PC platform
- On-line management via LAN
- Data is stored in SQL database
- Access to server from any Windows based PC with the client installed, connected to the internet
- The user is able to
 - book places using up to 3 different colours
 - book places using a scheduler
 - monitor places and areas
 - monitor history and instantaneous values
 - select displays that show available spaces for zones
- Carpark Server and Mobile API

Product Description

The Carpark Software is an application that gives you information achieved from your Carpark installation. It consists of two components, the server and the client. The server is installed on a Windows-based PC and manages the data traffic between the Carpark facility and the PC. The server is connected to the LAN/Internet that passes the communication from the Dupline Master Modules which in term monitors the parking places, or from the MZC as emulated ID numbers.

The Carpark client is installed on a Windows-based PC that is connected to LAN/Internet, which in term is connected to the PC which runs the Server. The client can monitor the parking facility in real-time. It can, once connected to the server on a remote location, have full access to all the data that is logged on the Server. The client also acts as the designing tool for the Carpark facility, so that full graphical overview can be achieved in an easy way. The system is built-up using Microsoft SQL Express database tool.

Type Selection

Carpark Server Software Ordering no.

DUP-PGS-SW250	250 parking places
DUP-PGS-SW500	500 parking places
DUP-PGS-SW1000	1000 parking places
DUP-PGS-SW2000	2000 parking places
DUP-PGS-SW3000	3000 parking places
DUP-PGS-SW4000	4000 parking places
DUP-PGS-SW5000	5000 parking places
DUP-PGS-SW6000	6000 parking places
DUP-PGS-SW7000	7000 parking places
DUP-PGS-SW8000	8000 parking places
DUP-PGS-SW9000	9000 parking places
DUP-PGS-SW10000	10000 parking places

(Other parking place numbers on request)

Carpark Client Software

Free download from the internet address www.product-selection.net

System Requirements

The PC hardware requirements are:

Client: Operating Systems: Windows XP; Windows Vista; Windows 7

Processor: Follow Operation System requirement

RAM: Follow Operation System requirement

Hard Disk: Minimum 1 GB of available space

Display: 1024 x 768 high color, 32-bit (Minimum); 1600 x 1200 high color, 32-bit.

Recommended: 24" display, capable of showing 1600 x 1200 pixels in high color.

Server:

Operating Systems: Windows Server 2003; Windows

Server 2008; Windows XP; Windows Vista; Windows 7

Processor: Core 2 Duo 2GHz Pentium processor or equivalent (Recommended)

Mode of Operation

The Carlo Gavazzi Parking Guidance System (DUP-PGS-SWxxxxx) is a Windows based software tool to monitor and control CarPark places. The DUP-PGS-SWxxxxx consists of a client and a server part. The client is normally the PC which the operator uses to monitor and reserve parking places. In an easy way the operator can get a full overview of the complete parking area and also be able to help customers with reservations.

The server receives data from the master modules or from the MZC as emulated ID numbers, via the LAN. The received data is online data from the CarPark facility. All the data is stored in a database on the server. The server is used to configure the program for the CarPark places.

It is possible to have many clients but there can only be one server in a system.

The server is the heart in the system. The server has all the programming and communicates with the entire master modules through the LAN.

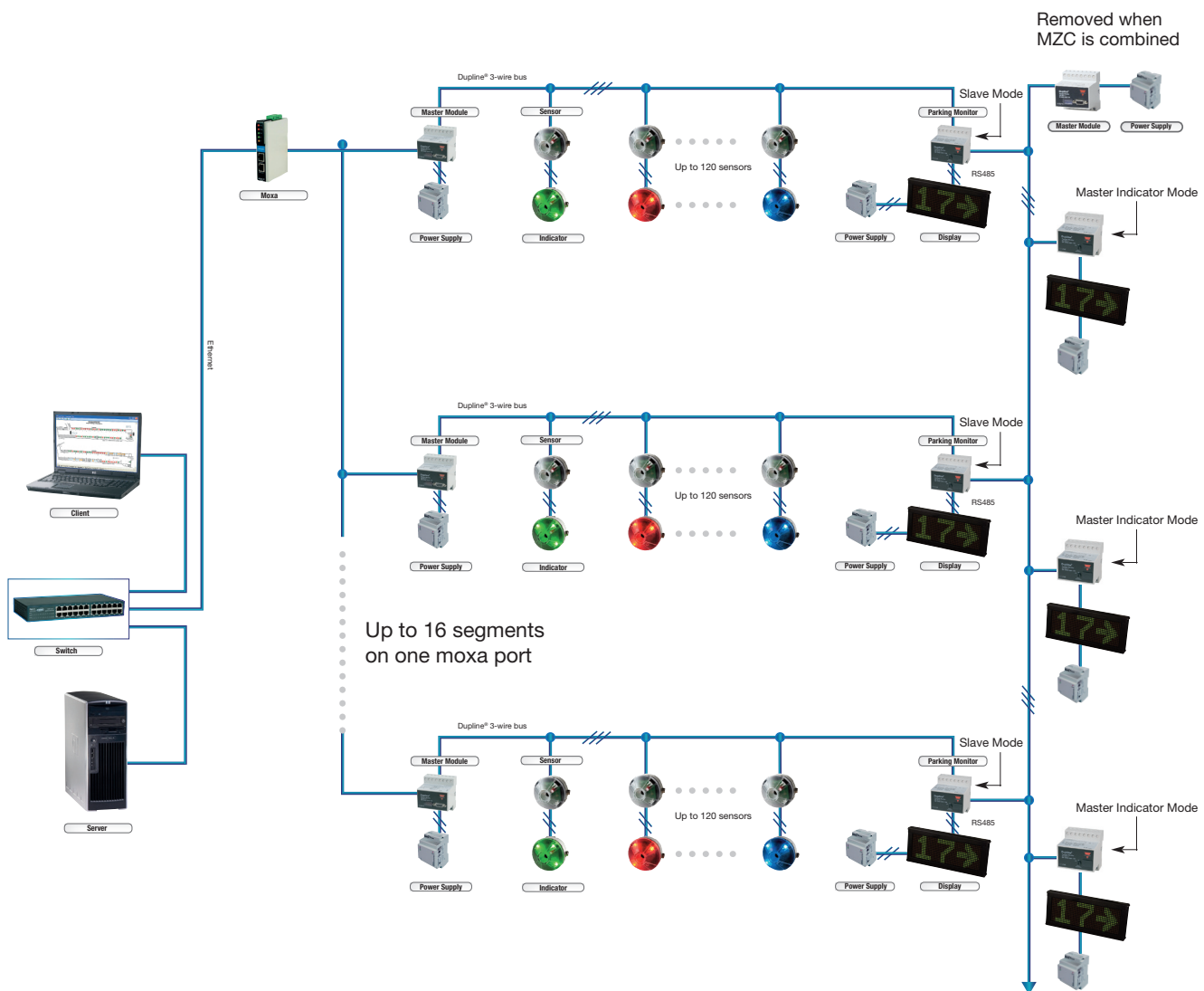

The client (or clients) is also connected to the LAN. The client is the application for the operator of the system, who wants to receive information from the parking facility. The design of the parking facility is done by means of the client, where diagrams, pictures etc. can be uploaded as background for the programming.

It is possible to make static reports, view the Carpark status online, make bookings, view different kind of parking occupancy etc. Several levels of rights can be used, so that more users with different interests can get access to the server, according to their needs.

The client user can achieve data from the server, and transfer them to a spreadsheet in order to build statistical information for other use.

Mode of Operation

Area	Timestamp	Alarms	Occupied	Free	Handicap Occupied	Handicap Free	Booked Occupied	Booked Free	Places	Handicap	Booked	Error
DEMO Facility	2010-04-08 11:15:51	0	87	42	5	7	16	18	129	12	34	0
Busgaden	2010-04-08 11:15:51	0	83	22	5	1	12	10	105	6	22	0
Level 1	2010-04-08 11:15:51	1	51	2	5	1	0	0	53	6	0	0
Level 2	2010-04-08 11:15:51	0	32	20	0	0	12	10	52	0	22	0
DEMO	2010-04-08 11:15:51	0	4	20	0	6	4	8	24	6	12	0

The user of the client will also be informed whenever an alarm is detected. The types of alarms are set in the client setup part of the application.

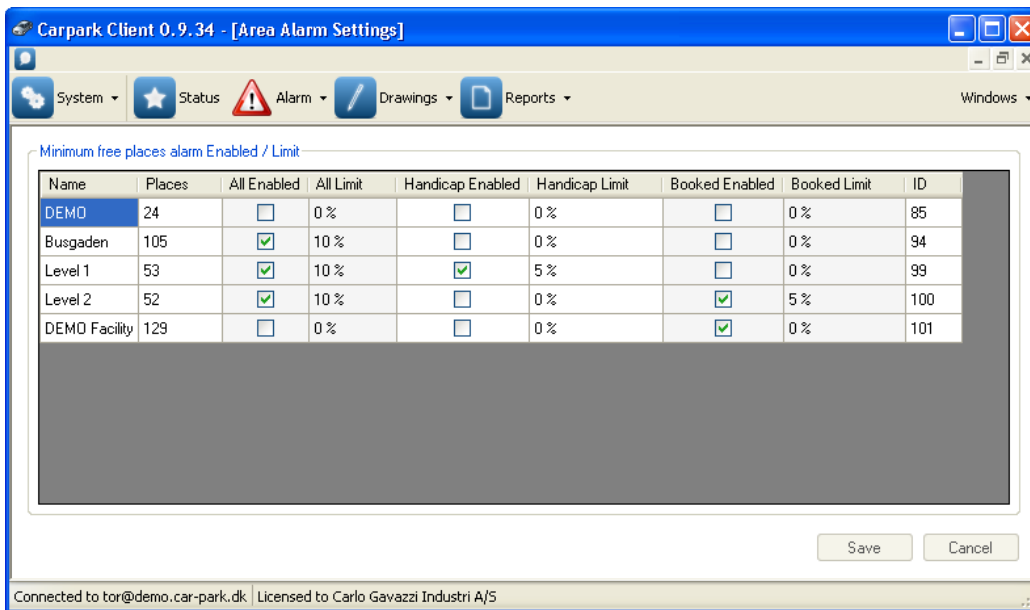

The alarms will be visible for any user, and can be acknowledged by the users who have the rights to do that.

The client is able to read the instantaneous status of the sensors of the facility. It is able to show the actual status on the screen both graphically and in table format.

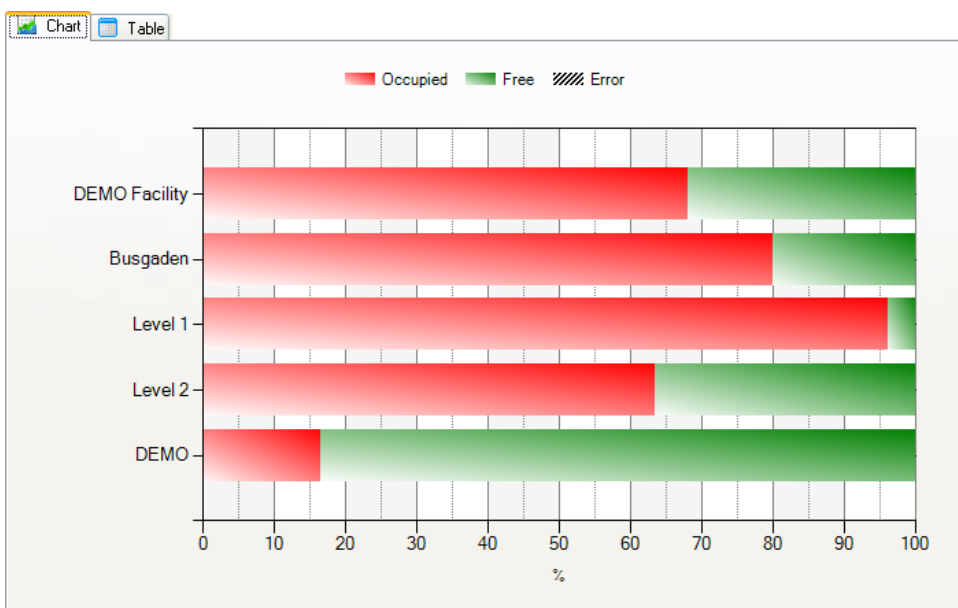

Mode of Operation

Area	Timestamp	Alarms	Occupied	Free	Handicap Occupied	Handicap Free	Booked Occupied	Booked Free	Places	Handicap	Booked	Error
DEMO Facility	2010-04-08 11:15:51	0	87	42	5	7	16	18	129	12	34	0
Busgaden	2010-04-08 11:15:51	0	83	22	5	1	12	10	105	6	22	0
Level 1	2010-04-08 11:15:51	1	51	2	5	1	0	0	53	6	0	0
Level 2	2010-04-08 11:15:51	0	32	20	0	0	12	10	52	0	22	0
DEMO	2010-04-08 11:15:51	0	4	20	0	6	4	8	24	6	12	0

Data can be shown graphically to give a good view of the situation on the facility. The data can also be exported to a spreadsheet used for other purposes. Using a Scheduler, the operator can schedule booking.

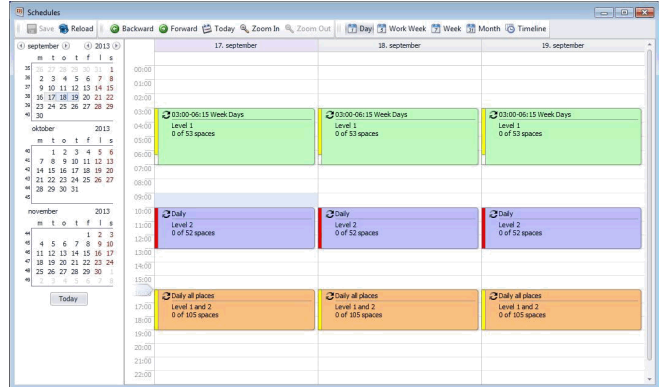
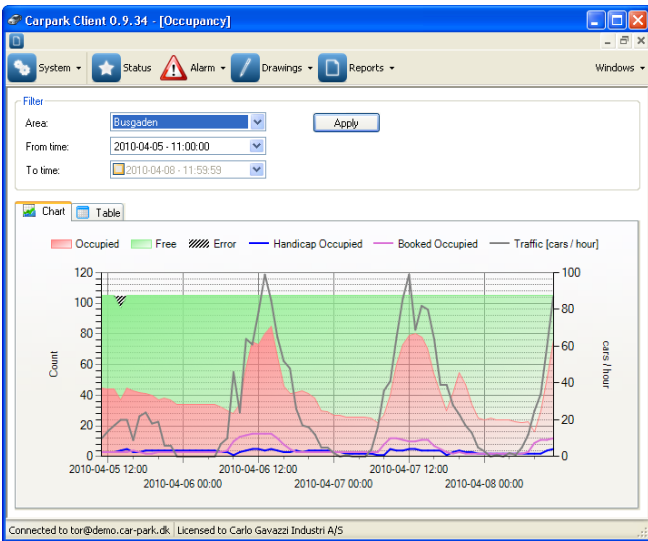

The Carpark software has the option to select API services (Application Programming interface). In the Carpark server this service can be enabled for e.g. Space Status Web Service and Mobile Site Web Service. The documentation how to implement the functions is described in the documentation for the Carpark server. See homepage : Car-Park.dk/download

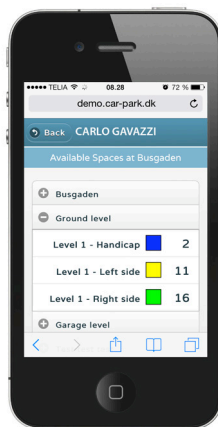
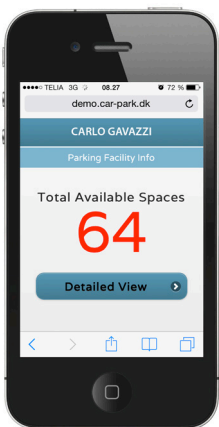

Mouser Electronics

Authorized Distributor

Click to View Pricing, Inventory, Delivery & Lifecycle Information:

[Carlo Gavazzi:](#)

[DUP-PGS-SW4000](#) [DUP-PGS-SW7000](#) [DUP-PGS-SW3000](#) [DUP-PGS-SW500](#) [DUP-PGS-SW6000](#) [DUP-PGS-SW250](#) [DUP-PGS-SW8000](#) [DUP-PGS-SW1000](#) [DUP-PGS-SW5000](#) [DUP-PGS-SW10000](#) [DUP-PGS-SW2000](#) [DUP-PGS-SW9000](#)