

BR/SUxxxUC Series

UL 489 and UL 1077 - AC/DC Rated
Miniature Circuit Breakers

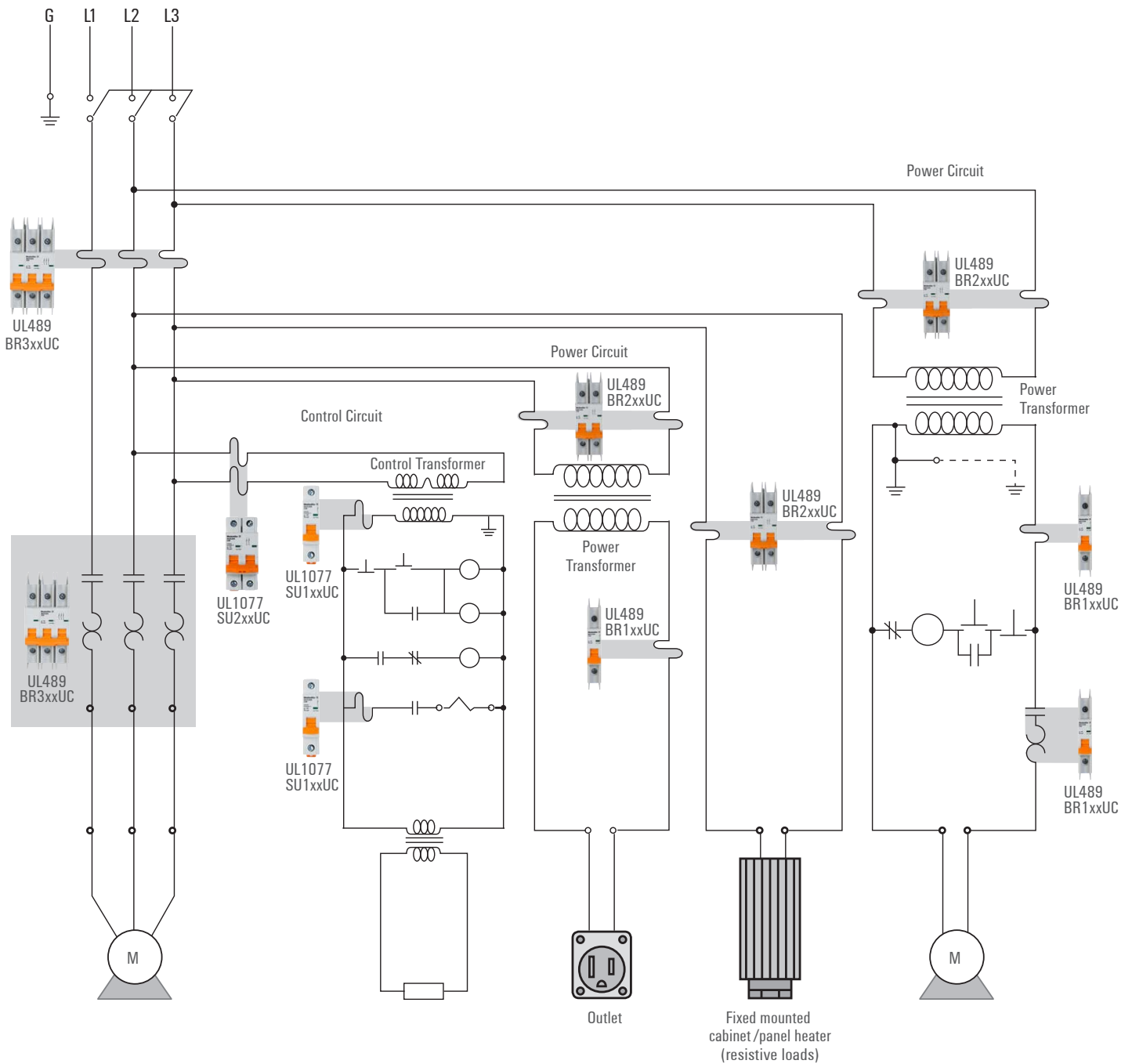

Application Schematic



Sizing of main branch circuit protector according to table 430.52 in NEC®

- **Dual Element (Time Delay) Fuse**
 Maximum fuse = largest motor FLA x 175%
 + FLA of all other motors and general loads in group
- **Inverse Time Breaker**
 Maximum circuit breaker = largest motor FLA x 250%
 + FLA of all other motors and general loads in group
 (for other fuse/breaker types see table 430.52)

UL 489 and UL 1077 DIN-Rail Miniature Circuit Breakers

Weidmuller offers a complete line of thermal magnetic circuit breakers with its BRxxxUC product line engineered for either AC or DC branch circuit protection and the SUxxxUC product line designed for supplementary protection. These circuit breakers are proven solutions to protect your wires and cables from application or device malfunctions.

Introduction	2
Choose the Right Weidmuller BR/SUxxxUC Series Miniature Circuit Breaker	2
Applications	3
BR and SU Series Product Overview	4
UL 489 DIN-Rail Branch Circuit Breakers	5
BRxxxUC Product Selection	6
UL 1077 DIN-Rail Supplementary Circuit Breakers	7
SUxxxUC Product Selection	8
Trip Curves	9
Accessories	11
Accessory Modules	11
Auxiliary Contact	11
Bell Alarm Contact	12
Shunt Trip	13
Accessory Modules Installation Diagram	14
Accessory Modules Mounting Instructions	15
Busbar and Busbar Accessories	16
Busbar UL 489 – Cuttable	16
Busbar UL 1077 – Cuttable	18
Terms	20
Additional Technical Information	21
Operation and Components of BR/SUxxxUC MCBs	21
Weidmuller UC Series Thermal Magnetic Definition	22
Examples of Trip Curve Interpretation – Reading Trip Curves	23
Ambient Temperature Derating	24
UC Series D Curve Thermal Magnetic Tripping Characteristics vs K Curve	25
Additional Weidmuller Offerings	27
CB4200 Series Circuit Breakers	27

Introduction

Choose the Right Weidmüller BR/SUxxxUC Series Miniature Current Breaker (MCB) (Always refer to the NEC before installing any device.)

When considering the BR/SUxxxUC Series MCBs, always assess the application for the following: voltage rating, maximum interrupting capacity, continuous current rating, frequency, and atypical operating conditions (ambient temperature, moisture, vibration, altitude, installation or operation orientation, and field maintenance). The MCBs are intended to protect the circuit cables as well as motors, generators and transformers, thyristors and silicon rectifiers. They also provide additional protection of computers and their peripheral equipment, industrial process control systems, telecommunications equipment and power supplies.

Ask the following:

- Is the application an AC or DC circuit?
Good news here, BR/SUxxxUC MCBs are rated for both AC and DC.
- Is a branch or supplemental breaker needed for the application?
Branch devices may be used in place of supplemental but not vice versa.
- How many poles are needed for each circuit being protected?
3p – 3 phase no neutral, 2p – L₁ and Neutral, 1p – L₁ only.
- Calculate and/or measure the normal current for the circuit and follow NEC guidelines. Match the breaker amps based on the normal current load. Weidmüller's BR/SUxxxUC run 1 to 63 amps (See Technical Data on page 4).
- Determine potential failure mode(s).
BR/SUxxxUC MCB thermal magnetic devices are designed for interrupt short-circuit and overload events.
- What is the interrupt capacity (IC)?
Specify the breaker knowing the maximum fault current that can be repeatedly interrupted without failure of the breaker. BR/SUxxxUC MCBs have a maximum current at a given voltage that the breaker can interrupt safely without damage to surrounding components. (See Technical Data)
- What is the reaction time needed to a given fault condition?
Specify a breaker by selecting a speed that avoids nuisance tripping but protects against component damage (B, C or D curve)
- What are the functional requirements of the breaker?
The BR/SUxxxUC are rail mountable, easy to visually inspect, switch manually (or remotely trip with shunt trip devices) and monitor using an auxiliary contact. Mechanically 20,000 cycles and electrically 6,000 cycles.
- What is the wire size used? Can the breaker accept the wire sizes required?
The BR/SUxxxUC are designed for $\leq 35\text{mm}^2$.
- What are the environmental factors: ambient temperature, moisture, vibration?
Check to determine if there are unusual conditions in which the breaker must operate. The BR/SUxxxUC are specified to IP20, $-35^{\circ}\text{C} \dots 70^{\circ}\text{C}$, and shock tested to IEC 60068-2-27.

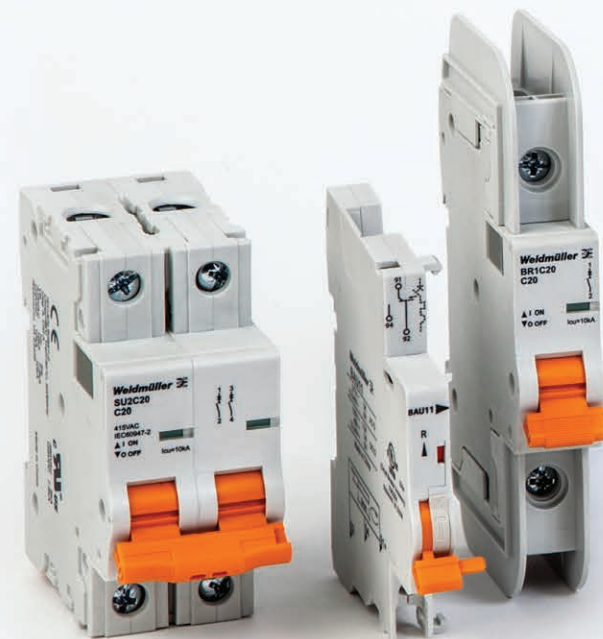

Applications

- Automotive Manufacturing
- Chemical, Oil and Gas
- Renewable Energy
- Rail Vehicles
- Automation
- Pharmaceutical and Food
- Steel Production
- Telecom and Datacom
- Power-D-Box-Systems
- Lighting Equipment
- Process Control



Pharmaceutical and Food



Chemical, Oil and Gas



Automotive Manufacturing



Rail Vehicles



BR and SU Series

Description

1-, 2- and 3-pole thermal-magnetic miniature circuit breakers (MCBs) in accordance with EN 60947-2, UL 1077 and UL 489 for DIN-rail mounting, with toggle actuation, visual status indication and high rupture capacity. A positively trip-free snap action mechanism ensures reliable switching behavior. A range of trip characteristics and add-on modules allow a great variety of applications.

Typical Applications

- Protection of cables, motors, generators and transformers, thyristors and silicon rectifiers.
- Protection of computers and their peripheral equipment, industrial process control systems, telecommunications equipment, power supplies.



BR Series UL 489 version



SU Series IEC/EN60947-2 & UL 1077 version

Technical Data

Voltage rating and current rating range					
to IEC/EN 60947-2		1-pole: AC 240 V; 1 A...63 A; 2 and 3-pole: AC 415 V, 1 A...63 A			
		1-pole: DC 80 V, 1 A...63 A			
		2-pole: (2 poles connected in series) DC 125 V, 1...63 A			
to UL 1077		1-pole: AC 277 V; 1 A...63 A; 2 and 3-pole: AC 480Y/277 V, 1 A...63 A			
		1-pole: DC 60 V; 1 A...63 A			
		2-pole (2 poles connected in series): DC 125 V; 1 A...63 A			
to UL 489		1-pole: AC 120 V; 1 A...63 A; 2 and 3-pole: AC 240 V, 1 A...63 A; 1-pole: AC 277 V; 1 A...32 A; 2 and 3-pole: AC 480Y/277 V; 1 A...32 A;			
		1-pole: DC 60 V; 1 A...63 A			
		2-pole (2 poles connected in series); DC 125 V; 1 A...63 A			
Typical life					
Mechanically		20,000 cycles			
Electrically		6,000 cycles			
Interrupt capacity					
to IEC/EN 60947-2 (Ics)		AC 7,500 A / DC 10,000 A			
to IEC/EN 60947-2 (Icu)		AC/DC 10,000 A			
to UL 489		AC/DC 10,000 A			
to UL1077					
Number of poles	Un	In	TC	OL	SC
1-pole	AC 240 V	1...63 A	1	1	7.5 kA, U1
1-pole	AC 277 V	1...63 A	1	0	5 kA, U1
2-, 3-pole	AC 480 V	1...63 A	1	1	5 kA, U1
1-pole	DC 60 V	1...63 A	1	0	7.5 kA, U1
2-pole in series	DC 125 V	1...63 A	1	0	7.5 kA, U1
Insulation coordination		6 kV/3 (reinforced insulation at operating area)			

Degree of protection	IP20
Vibration (sinusoidal) test to IEC 60068-2-6, test Fc	± 0.38 mm (10–57 Hz), 5 g (57–500 Hz) 10 frequency cycles per axis
Shock, test to IEC 60068-2-27, test Ea	30 g (11 ms)
Corrosion, test to IEC 60068-2-11, test Ka	96 hrs in 5% salt mist
Humidity, test to IEC 60068-2-78, test Cab	48 hours at 95% RH, temperature +40°C
Terminals	screw terminals; Vertical connection possible by means of busbars
Tightening torque	2 Nm max.
Cable cross section	≤35 mm ²
Ambient temperature	-35°C...+70°C
Mounting	rail mounting
Mass	approx. 116 g per pole (EN 60947-2/ UL 1077) approx. 131 g per pole (UL 489)

Approvals

Approval authority	Standard	Rated voltage	Current ratings
TÜV	IEC/EN 60947-2	AC 240/415 V DC 80 V DC 125 V	1...63 A 1...63 A (1-pole) 1...63 A (2 poles in series)
UL	UL 1077 / CSA-C22.2 No. 235	AC 480Y/277 V DC 60 V DC 125 V	1...63 A 1...63 A (1-pole) 1...63 A (2 poles in series)
UL	UL 489 / CSA-C22.2 No. 5	AC 240 V AC 480Y/277 V DC 60 V DC 125 V	1...63 A 1...32 A 1...63 A (1-pole) 1...63 A (2 poles in series)

For information on Weidmüller's UL Certifications, visit the UL Online Certifications Directory and search by the UL file numbers E359481, E362204 and E359964.



UL 489 DIN-Rail Branch Circuit Breakers BRxxxUC

BR Series Product Selection Part Number Nomenclature

(Part Number found on the front of the breaker)

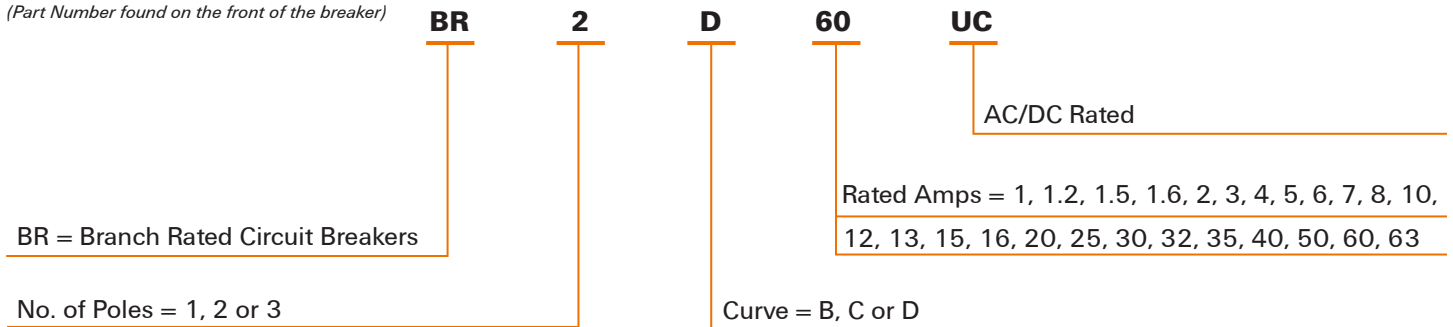

Schematic Diagrams

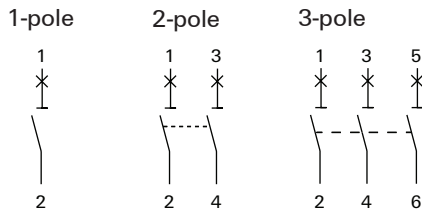

DC Application

When using the BR/SUxxxUC in DC applications, polarity does not have to be observed. Maximum acceptable voltage between the conductors depends on the number of poles, circuitry and relevant standard / approval.

To UL 489:

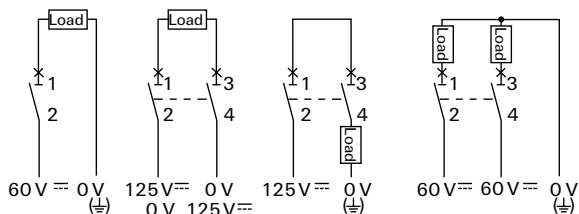

Dimensions - UL 489 version

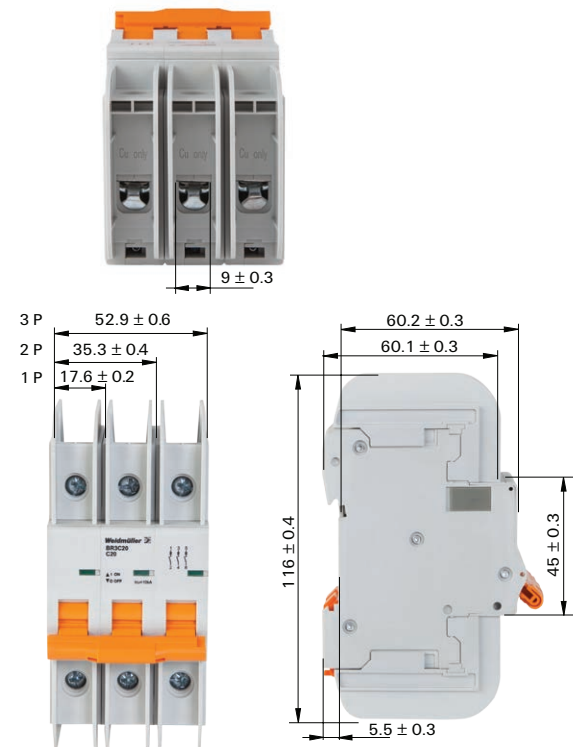

All dimensions without tolerances are for reference only. Weidmüller reserves the right to change specifications at any time without notice in the interest of improved design, performance and cost effectiveness.

BR Series Product Selection

X = B, C, or D Curve

(See Curve Drawings on page 9 and 10)

Amps	1 Pole		2 Pole		3 Pole	
1	BR1x1UC	MCB 489 1P x 1A ACDC	BR2x1UC	MCB 489 2P x 1A ACDC	BR3x1UC	MCB 489 3P x 1A ACDC
1.2	BR1x1.2UC	MCB 489 1P x 1.2A ACDC	BR2x1.2UC	MCB 489 2P x 1.2A ACDC	BR3x1.2UC	MCB 489 3P x 1.2A ACDC
1.5	BR1x1.5UC	MCB 489 1P x 1.5A ACDC	BR2x1.5UC	MCB 489 2P x 1.5A ACDC	BR3x1.5UC	MCB 489 3P x 1.5A ACDC
1.6	BR1x1.6UC	MCB 489 1P x 1.6A ACDC	BR2x1.6UC	MCB 489 2P x 1.6A ACDC	BR3x1.6UC	MCB 489 3P x 1.6A ACDC
2	BR1x2UC	MCB 489 1P x 2A ACDC	BR2x2UC	MCB 489 2P x 2A ACDC	BR3x2UC	MCB 489 3P x 2A ACDC
3	BR1x3UC	MCB 489 1P x 3A ACDC	BR2x3UC	MCB 489 2P x 3A ACDC	BR3x3UC	MCB 489 3P x 3A ACDC
4	BR1x4UC	MCB 489 1P x 4A ACDC	BR2x4UC	MCB 489 2P x 4A ACDC	BR3x4UC	MCB 489 3P x 4A ACDC
5	BR1x5UC	MCB 489 1P x 5A ACDC	BR2x5UC	MCB 489 2P x 5A ACDC	BR3x5UC	MCB 489 3P x 5A ACDC
6	BR1x6UC	MCB 489 1P x 6A ACDC	BR2x6UC	MCB 489 2P x 6A ACDC	BR3x6UC	MCB 489 3P x 6A ACDC
7	BR1x7UC	MCB 489 1P x 7A ACDC	BR2x7UC	MCB 489 2P x 7A ACDC	BR3x7UC	MCB 489 3P x 7A ACDC
8	BR1x8UC	MCB 489 1P x 8A ACDC	BR2x8UC	MCB 489 2P x 8A ACDC	BR3x8UC	MCB 489 3P x 8A ACDC
10	BR1x10UC	MCB 489 1P x 10A ACDC	BR2x10UC	MCB 489 2P x 10A ACDC	BR3x10UC	MCB 489 3P x 10A ACDC
12	BR1x12UC	MCB 489 1P x 12A ACDC	BR2x12UC	MCB 489 2P x 12A ACDC	BR3x12UC	MCB 489 3P x 12A ACDC
13	BR1x13UC	MCB 489 1P x 13A ACDC	BR2x13UC	MCB 489 2P x 13A ACDC	BR3x13UC	MCB 489 3P x 13A ACDC
15	BR1x15UC	MCB 489 1P x 15A ACDC	BR2x15UC	MCB 489 2P x 15A ACDC	BR3x15UC	MCB 489 3P x 15A ACDC
16	BR1x16UC	MCB 489 1P x 16A ACDC	BR2x16UC	MCB 489 2P x 16A ACDC	BR3x16UC	MCB 489 3P x 16A ACDC
20	BR1x20UC	MCB 489 1P x 20A ACDC	BR2x20UC	MCB 489 2P x 20A ACDC	BR3x20UC	MCB 489 3P x 20A ACDC
25	BR1x25UC	MCB 489 1P x 25A ACDC	BR2x25UC	MCB 489 2P x 25A ACDC	BR3x25UC	MCB 489 3P x 25A ACDC
30	BR1x30UC	MCB 489 1P x 30A ACDC	BR2x30UC	MCB 489 2P x 30A ACDC	BR3x30UC	MCB 489 3P x 30A ACDC
32	BR1x32UC	MCB 489 1P x 32A ACDC	BR2x32UC	MCB 489 2P x 32A ACDC	BR3x32UC	MCB 489 3P x 32A ACDC
35	BR1x35UC	MCB 489 1P x 35A ACDC	BR2x35UC	MCB 489 2P x 35A ACDC	BR3x35UC	MCB 489 3P x 35A ACDC
40	BR1x40UC	MCB 489 1P x 40A ACDC	BR2x40UC	MCB 489 2P x 40A ACDC	BR3x40UC	MCB 489 3P x 40A ACDC
50	BR1x50UC	MCB 489 1P x 50A ACDC	BR2x50UC	MCB 489 2P x 50A ACDC	BR3x50UC	MCB 489 3P x 50A ACDC
60	BR1x60UC	MCB 489 1P x 60A ACDC	BR2x60UC	MCB 489 2P x 60A ACDC	BR3x60UC	MCB 489 3P x 60A ACDC
63	BR1x63UC	MCB 489 1P x 63A ACDC	BR2x63UC	MCB 489 2P x 63A ACDC	BR3x63UC	MCB 489 3P x 63A ACDC

UL 1077 DIN-Rail Supplementary Circuit Breakers SUxxxUC

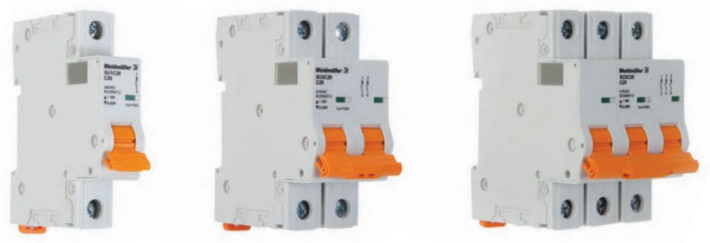

SU Series Product Selection Part Number Nomenclature

(Part Number found on the front of the breaker)

SU

2

D

60

UC

AC/DC Rated

SU = Supplementary Protectors

No. of Poles = 1, 2 or 3

Rated Amps = 1, 1.2, 1.5, 1.6, 2, 3, 4, 5, 6, 7, 8, 10, 12, 13, 15, 16, 20, 25, 30, 32, 35, 40, 50, 60, 63

Curve = B, C or D

Schematic Diagrams

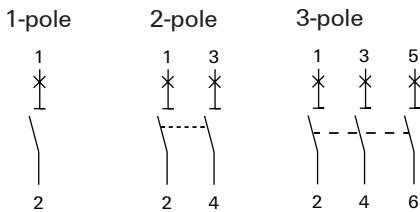

Dimensions - IEC/EN 60947-2 / UL1077 version

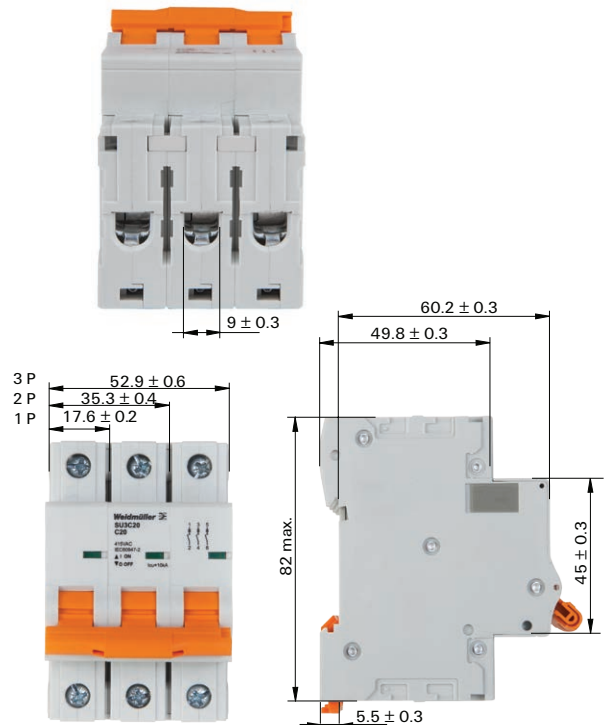

DC Application

When using the BR/SUxxxUC in DC applications, polarity does not have to be observed. Maximum acceptable voltage between the conductors depends on the number of poles, circuitry and relevant standard / approval.

To IEC/EN 60947-2:

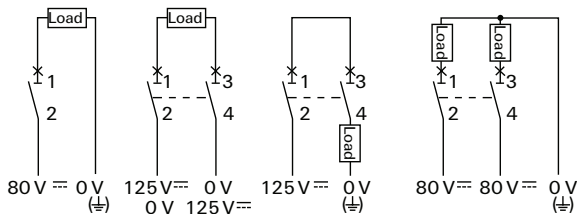

To UL 1077:

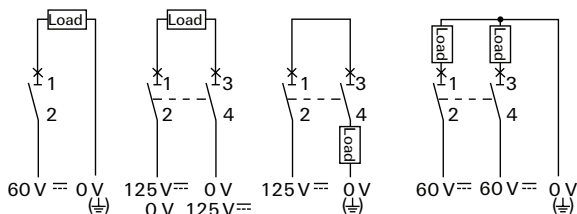

All dimensions without tolerances are for reference only. Weidmüller reserves the right to change specifications at any time without notice in the interest of improved design, performance and cost effectiveness.

SU Series Product Selection

x = B, C, or D Curve

(See Curve Drawings on page 9 and 10)

Amps	1 Pole		2 Pole		3 Pole	
1	SU1x1UC	MCB 1077 1P x 1A ACDC	SU2x1UC	MCB 1077 2P x 1A ACDC	SU3x1UC	MCB 1077 3P x 1A ACDC
1.2	SU1x1.2UC	MCB 1077 1P x 1.2A ACDC	SU2x1.2UC	MCB 1077 2P x 1.2A ACDC	SU3x1.2UC	MCB 1077 3P x 1.2A ACDC
1.5	SU1x1.5UC	MCB 1077 1P x 1.5A ACDC	SU2x1.5UC	MCB 1077 2P x 1.5A ACDC	SU3x1.5UC	MCB 1077 3P x 1.5A ACDC
1.6	SU1x1.6UC	MCB 1077 1P x 1.6A ACDC	SU2x1.6UC	MCB 1077 2P x 1.6A ACDC	SU3x1.6UC	MCB 1077 3P x 1.6A ACDC
2	SU1x2UC	MCB 1077 1P x 2A ACDC	SU2x2UC	MCB 1077 2P x 2A ACDC	SU3x2UC	MCB 1077 3P x 2A ACDC
3	SU1x3UC	MCB 1077 1P x 3A ACDC	SU2x3UC	MCB 1077 2P x 3A ACDC	SU3x3UC	MCB 1077 3P x 3A ACDC
4	SU1x4UC	MCB 1077 1P x 4A ACDC	SU2x4UC	MCB 1077 2P x 4A ACDC	SU3x4UC	MCB 1077 3P x 4A ACDC
5	SU1x5UC	MCB 1077 1P x 5A ACDC	SU2x5UC	MCB 1077 2P x 5A ACDC	SU3x5UC	MCB 1077 3P x 5A ACDC
6	SU1x6UC	MCB 1077 1P x 6A ACDC	SU2x6UC	MCB 1077 2P x 6A ACDC	SU3x6UC	MCB 1077 3P x 6A ACDC
7	SU1x7UC	MCB 1077 1P x 7A ACDC	SU2x7UC	MCB 1077 2P x 7A ACDC	SU3x7UC	MCB 1077 3P x 7A ACDC
8	SU1x8UC	MCB 1077 1P x 8A ACDC	SU2x8UC	MCB 1077 2P x 8A ACDC	SU3x8UC	MCB 1077 3P x 8A ACDC
10	SU1x10UC	MCB 1077 1P x 10A ACDC	SU2x10UC	MCB 1077 2P x 10A ACDC	SU3x10UC	MCB 1077 3P x 10A ACDC
12	SU1x12UC	MCB 1077 1P x 12A ACDC	SU2x12UC	MCB 1077 2P x 12A ACDC	SU3x12UC	MCB 1077 3P x 12A ACDC
13	SU1x13UC	MCB 1077 1P x 13A ACDC	SU2x13UC	MCB 1077 2P x 13A ACDC	SU3x13UC	MCB 1077 3P x 13A ACDC
15	SU1x15UC	MCB 1077 1P x 15A ACDC	SU2x15UC	MCB 1077 2P x 15A ACDC	SU3x15UC	MCB 1077 3P x 15A ACDC
16	SU1x16UC	MCB 1077 1P x 16A ACDC	SU2x16UC	MCB 1077 2P x 16A ACDC	SU3x16UC	MCB 1077 3P x 16A ACDC
20	SU1x20UC	MCB 1077 1P x 20A ACDC	SU2x20UC	MCB 1077 2P x 20A ACDC	SU3x20UC	MCB 1077 3P x 20A ACDC
25	SU1x25UC	MCB 1077 1P x 25A ACDC	SU2x25UC	MCB 1077 2P x 25A ACDC	SU3x25UC	MCB 1077 3P x 25A ACDC
30	SU1x30UC	MCB 1077 1P x 30A ACDC	SU2x30UC	MCB 1077 2P x 30A ACDC	SU3x30UC	MCB 1077 3P x 30A ACDC
32	SU1x32UC	MCB 1077 1P x 32A ACDC	SU2x32UC	MCB 1077 2P x 32A ACDC	SU3x32UC	MCB 1077 3P x 32A ACDC
35	SU1x35UC	MCB 1077 1P x 35A ACDC	SU2x35UC	MCB 1077 2P x 35A ACDC	SU3x35UC	MCB 1077 3P x 35A ACDC
40	SU1x40UC	MCB 1077 1P x 40A ACDC	SU2x40UC	MCB 1077 2P x 40A ACDC	SU3x40UC	MCB 1077 3P x 40A ACDC
50	SU1x50UC	MCB 1077 1P x 50A ACDC	SU2x50UC	MCB 1077 2P x 50A ACDC	SU3x50UC	MCB 1077 3P x 50A ACDC
60	SU1x60UC	MCB 1077 1P x 60A ACDC	SU2x60UC	MCB 1077 2P x 60A ACDC	SU3x60UC	MCB 1077 3P x 60A ACDC
63	SU1x63UC	MCB 1077 1P x 63A ACDC	SU2x63UC	MCB 1077 2P x 63A ACDC	SU3x63UC	MCB 1077 3P x 63A ACDC

Trip Curves

Trip Curves B, C, D – overcurrent protection of cables in accordance with IEC/EN 60898-1 and IEC 60947-2

Time/Current Characteristics

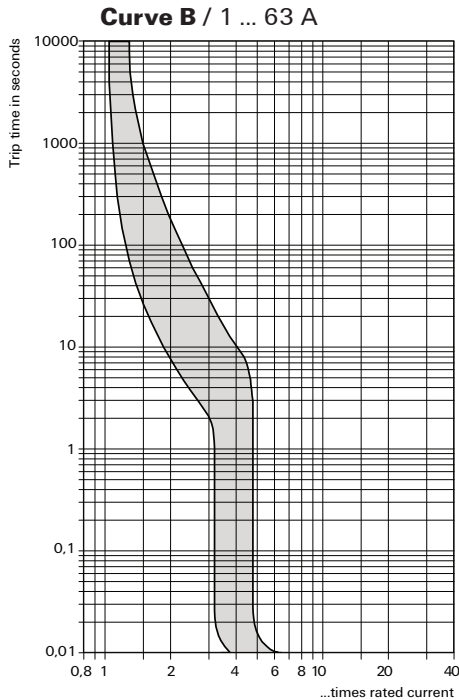

Magnetic tripping currents are increased by 30 % on DC supplies.
Ambient temperature 30 °C

Trip between 3-5X rated current (30-50 Amp for a 10 Amp device)

Residential and light commercial applications such as:

- Resistive loads (low surge current)
- Low switching surge current
- Wire protection
- Lighting
- Appliances

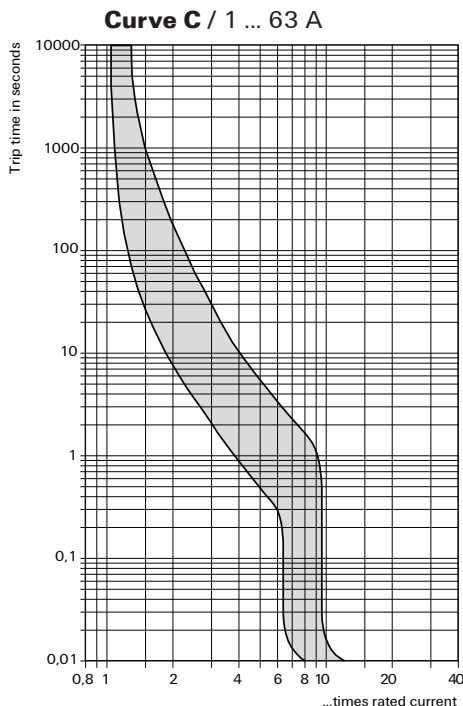

Magnetic tripping currents are increased by 30 % on DC supplies.
Ambient temperature 30 °C

Trip between 5-10X rated current (50-100 Amp for a 10 Amp device)

Commercial applications such as:

- Inductive loads
- Motors (low inrush current)
- Control circuitry
- Lighting
- Appliances

Curve D / 1 ... 63 A

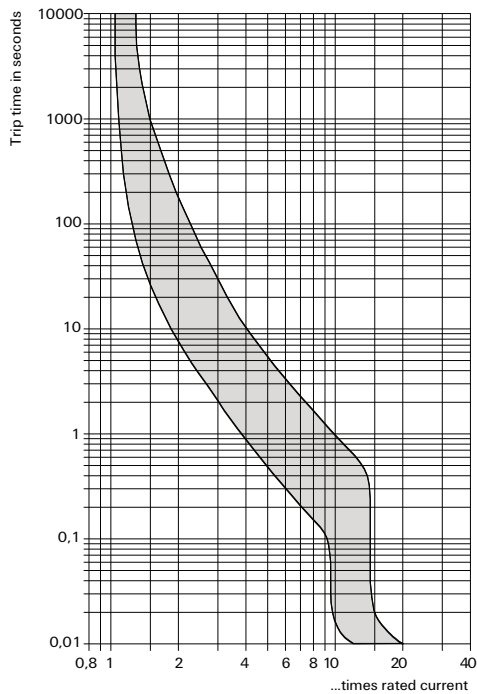

Trip between 10-20X rated current (100-200 Amp for a 10 Amp device)

Industrial applications such as:

- High inductive and capacitive loads
- Motors (higher inrush current)
- Power supplies
- Transformers
- Heaters
- X-ray machines
- Reactive loads

Current ratings and voltage drop at +25°C

Voltage drop in V at 1 I _N						
I _N (A)	1	1.2	1.5	1.6	2	3
V	1.50	1.50	0.80	0.80	0.80	0.60
I _N (A)	4	5	6	7	8	10
V	0.60	0.20	0.20	0.20	0.15	0.15
I _N (A)	12	13	15	16	20	25
V	0.15	0.10	0.10	0.10	0.08	0.08
I _N (A)	30	32	35	40	50	60
V	0.07	0.07	0.07	0.07	0.06	0.06
I _N (A)	63					
V	0.06					

Note: When mounted side-by-side, the breakers can only carry up to 80% of their rated current or a higher rating has to be selected

Accessories

Accessory Modules

Auxiliary Contact

Description

Add-on module for circuit breaker type BR/SUxxxUC. The auxiliary switch has a change-over contact as signal contact and is operated with actuation of the MCB. The module has screw terminals and is rated for AC and DC voltages.

Typical Applications

Status monitoring of MCB and/or the connected loads.

Description	Part Number
MCB AUX Contact 1NC	BAU10UC

Technical Data

Rated currents to IEC/EN 60947-5-1:					
Voltage ratings:	AC 240 V	AC 415 V	DC 24 V	DC 48 V	DC 130 V
Current ratings:	6 A	3 A	6 A	2 A	1 A
Rated currents to UL 489:					
Voltage ratings:	AC 12 ... 240 V	AC 277 V	DC 12 ... 24 V	DC 48 V	DC 110 ... 220 V
Current ratings:	6 A	3 A	6 A	3 A	1.5 A
Typical life	20,000 cycles				
Tightening torque	1 Nm max.				
Ambient temperature	-35°C ... +70°C				
Width	9 mm				
Mass	approx. 29 g				

Approvals

Approval authority	Standard
TÜV	IEC/EN 60947-5-1
UL	UL 489



Schematic Diagrams

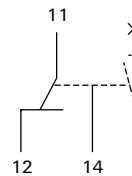

Note:

As soon as the auxiliary contact module is mounted on the MCB, the terminals 11 and 14 are connected when the MCB is in ON condition. Terminals 11 and 12 are connected when the MCB is in OFF condition.

Dimensions (in millimeters)

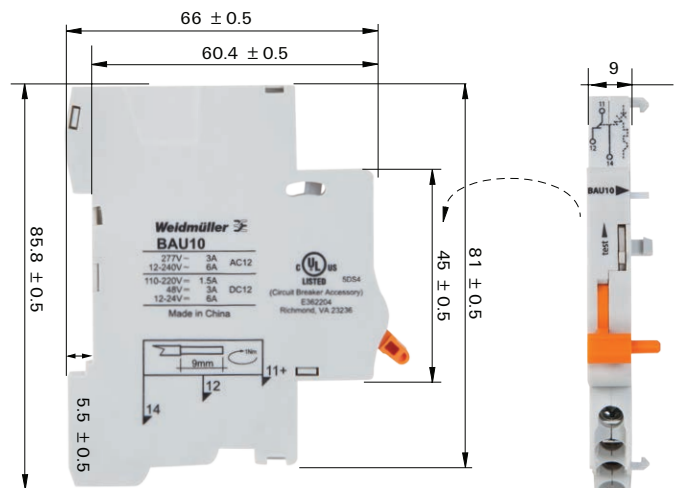

Bell Alarm Contact

Description

Add-on module for MCB type BR/SUxxxUC. The bell alarm contact has a change-over contact as signal contact. There will only be a signal when the MCB tripped on grounds of a failure (overload, short circuit), but and not when the MCB was switched on or off manually.

By actuating the reset lever on the front the tripping signal is acknowledged.

Typical Applications

Status monitoring of MCB and/or the connected loads.

Mounting

The add-on module is mounted on the left side of the MCB (seen from the front). For mounting, the MCB has to be in the OFF position.



Description	Part Number
MCB Bell Alarm Contact 1NC/1NO	BAU11UC

Technical Data

Rated currents to IEC/EN 60947-5-1:					
Voltage ratings:	AC 240 V	AC 415 V	DC 24 V	DC 48 V	DC 130 V
Current ratings:	6 A	3 A	6 A	2 A	1 A
Rated currents to UL 489:					
Voltage ratings:	AC 12 ... 240 V	AC 277 V	DC 12 ... 24 V	DC 48 V	DC 110 ... 220 V
Current ratings:	6 A	3 A	6 A	3 A	1.5 A
Typical life	20,000 cycles				
Tightening torque	1 Nm max.				
Ambient temperature	-35°C ...+70°C				
Width	9 mm				
Mass	approx. 29 g				

Approvals

Approval authority	Standard
UL	UL 489

Schematic Diagrams

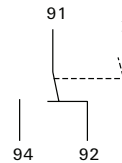

Note:

As soon as the bell alarm contact module is mounted on the MCB, the terminals 91 and 92 are connected when the MCB is in ON condition; the terminals 91 and 94 are connected when the MCB tripped electrically; the terminals 91 and 92 are connected when the MCB was tripped manually; at the same time the terminals 91 and 94 do not have contact.

Dimensions (in millimeters)

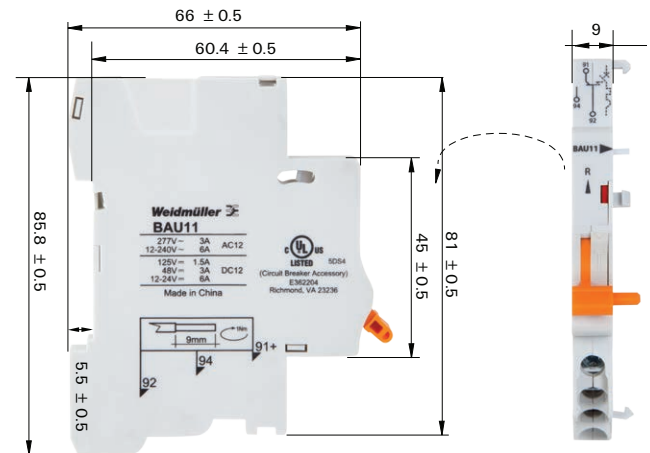

Shunt Trip

Description

Add-on module for MCB type BR/SUxxxUC. The shunt trip module serves for remote trip of the MCB and for signalling whether the MCB was tripped electrically or manually.

Typical Applications

Electrical remote trip of safety equipment with simultaneous monitoring of MCB status or its connected load.

Mounting

The add-on module is mounted on the left side of the MCB (seen from the front). For mounting, the MCB has to be in the OFF position. When auxiliary contact module/bell alarm contact module and a shunt trip module are mounted at the same time, the shunt trip module always has to be mounted first.

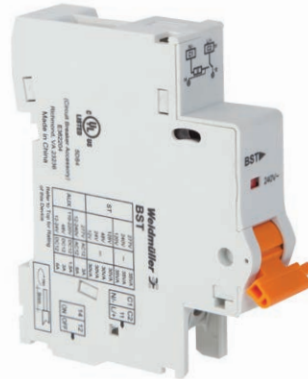

Description	Part Number
MCB SHUNT 1NC/1NO 12VDC	BST12VDC
MCB SHUNT 1NC/1NO 24VDC	BST24VDC
MCB SHUNT 1NC/1NO 48VDC	BST48VDC
MCB SHUNT 1NC/1NO 125VDC	BST125VDC
MCB SHUNT 1NC/1NO 120VAC	BST120VAC
MCB SHUNT 1NC/1NO 240VAC	BST240VAC
MCB SHUNT 1NC/1NO 277VAC	BST277VAC

Technical Data

	AC 277 V	AC 240 V	AC 120 V	
Voltage ratings AC	AC 277 V	AC 240 V	AC 120 V	
Min. trip voltage	AC 160 V	AC 160 V	AC 80 V	
Power consumption	240 W	200 W	200 W	
min. response power	35 W	35 W	35 W	
Rated current of auxiliary contact	3 A	6 A	6 A	
Voltage ratings DC	DC 125 V	DC 48 V	DC 24 V	DC 12 V
Min. trip voltage	DC 80 V	DC 24 V	DC 16 V	DC 8 V
Power consumption	200 W	200 W	200 W	200 W
min. response power	30 VA	30 VA	30 VA	30 VA
Rated current of auxiliary contact	1.5 A	2 A	6 A	6 A
Trip time	< 10 ms			
Typical life	20,000 cycles			
Tightening torque	1 Nm max.			
Ambient temperature	-35°C...+70°C			
Width	18 mm			
Mass	approx. 60 g			

Approvals

Approval authority	Standard
UL	UL 489

Schematic Diagrams

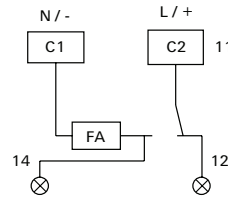

Dimensions (in millimeters)

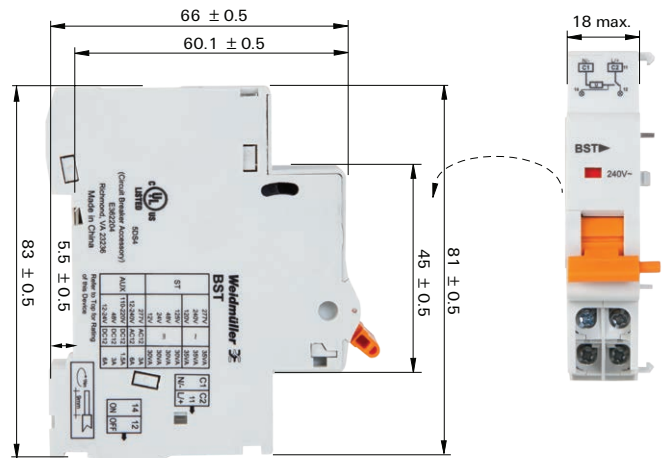

Accessories

Accessory Modules Installation Diagram

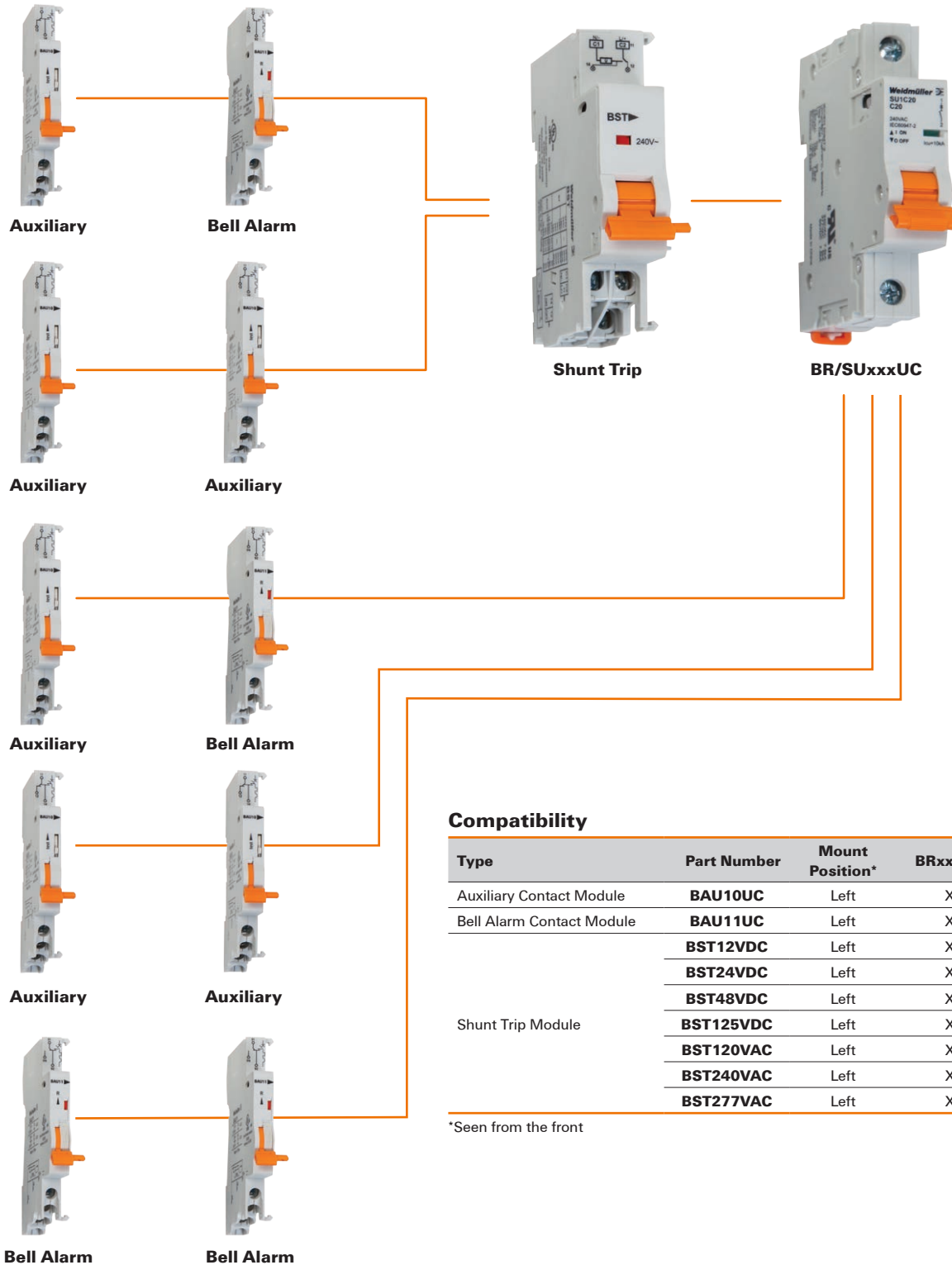

Compatibility

Type	Part Number	Mount Position*	BRxxxUC	SUxxxUC
Auxiliary Contact Module	BAU10UC	Left	X	X
Bell Alarm Contact Module	BAU11UC	Left	X	X
Shunt Trip Module	BST12VDC	Left	X	X
	BST24VDC	Left	X	X
	BST48VDC	Left	X	X
	BST125VDC	Left	X	X
	BST120VAC	Left	X	X
	BST240VAC	Left	X	X
	BST277VAC	Left	X	X

*Seen from the front

Mounting Instructions for the Accessory Modules

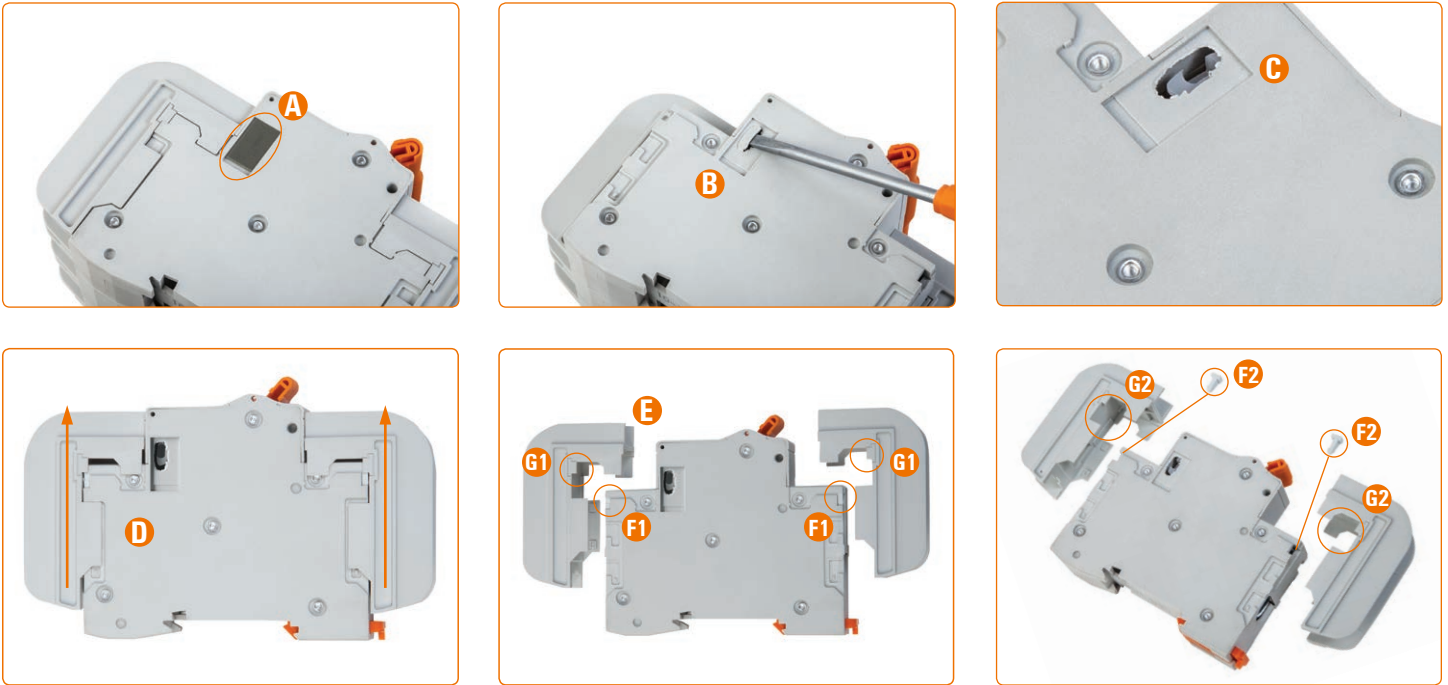

Preparing the MCB to connect the Auxiliary Contact, Bell Alarm Contact or Shunt Trip Module

- Use a small flat screwdriver to remove the clear plastic window (A) on the left side of the MCB (seen from the front). Do not remove the clear plastic window on the right side.
- Use the same screwdriver to remove the solid plastic cover (B) exposing the mechanical trip mechanism (C) beneath the window.
- For the BRxxxUCs only, slide the top and bottom fins forward and remove (D, E).
- For the BRxxxUCs, using small pliers remove the 2 plastic tabs on the fins (G1) and remove the 2 plugs from the breaker (F1) on the left side only.
 - For the SUxxxUCs, using small pliers remove the plugs from the breaker (F1).
 - G2 shows the plastic tabs removed and F2 shows the plugs removed.
- For the BRxxxUCs only, reattach the fins after installing the accessory module(s).

Accessory devices are left hand mounted only (seen from the front).

Accessories for Branch and Supplementary Circuit Breakers

Applies to BAU10UC, BAU11UC and BST:

The accessory modules can be installed on the left side only (seen from the front).

Mounting

1. Bring all orange levers of all devices into the "OFF" position
2. Insert guide pin into the lever handle notch (insertion depth approx. 7 mm)
3. Combine MCB and BAU10UC, BAU11UC or BST as outlined on page 14
4. Installation is complete when all snap together

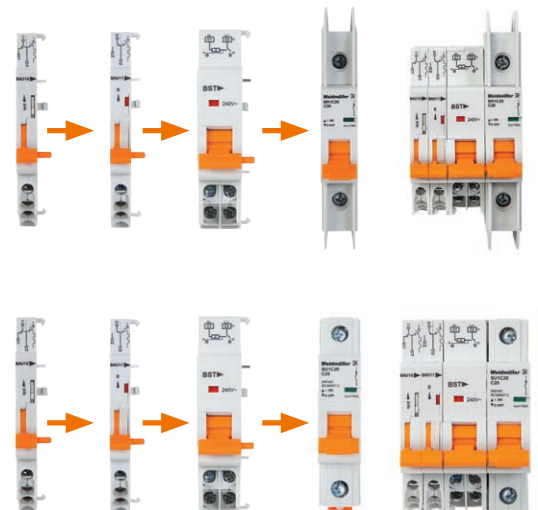

Accessories

Busbar and Busbar Accessories

Busbars UL 489 – cuttable

Description

Busbars for the connection of circuit breakers type BRxxxUC to UL 489. The busbars of 1 meter length can individually be cut to a suitable length for the application and isolated with end caps. Depending on the control cabinet design, the supply is by means of supply terminals without increasing the installation width or by means of a terminal block directly on the rail without increasing the installation height.

Three busbar models are available for use with auxiliary contact modules with a width of 9 mm.

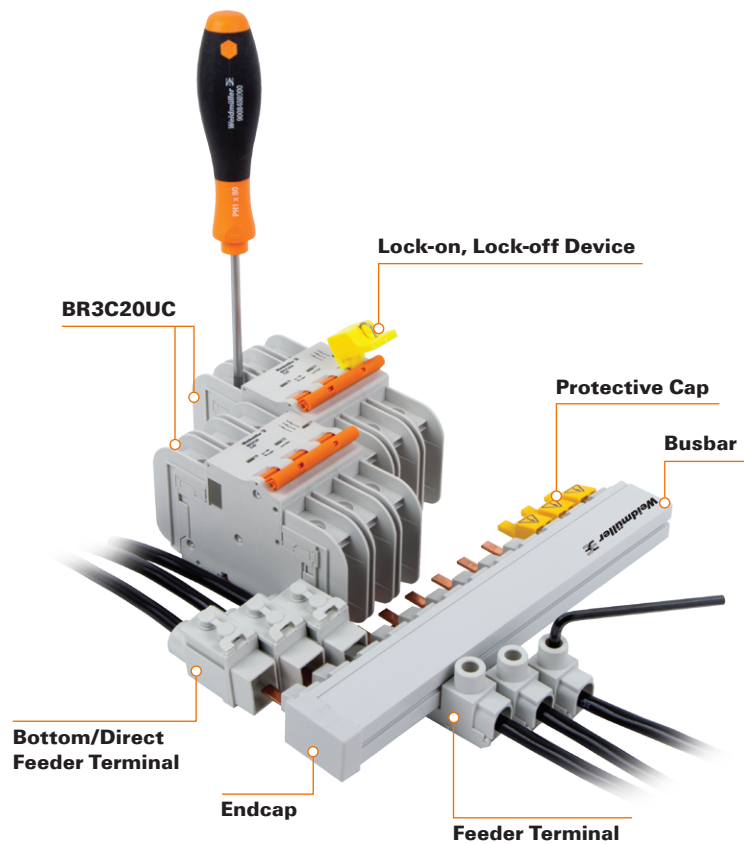

How to prepare the cuttable busbar

1. The busbar can be cut to individually required lengths for maximum flexibility

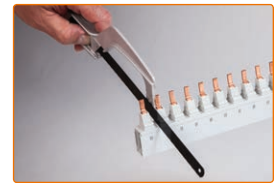

2. After cutting, clean the cut face



3. Attach an end cap for maximum finger safety



Technical Data

Part Number	No. of Poles	No. of Devices	No. of Pins	Cross Section	Max. Amperage	Max. Voltage	Pitch
BRBB157	1	57	57	18 mm ²	80 A	1000 V AC/DC	17.6 mm
BRBB256	2	28	56			600 V AC/DC	
BRBB357	3	19	57			600 V AC/DC	
BRBB137A*	1	37	37			1000 V AC/DC	
BRBB246A**	2	23	46			600 V AC/DC	
BRBB348A***	3	16	48			600 V AC/DC	

*,**,***See Ordering Data on page 17

Voltage Ratings	Single Phase	2 and 3 Phase
Max. AC Voltage	1000 V AC	600 V AC
Max. DC Voltage	1000 V DC	600 V DC
Current Ratings	End Feed	Center Feed
Max. Current 18 mm ² Cross Section	80 A	160 A†
Protection Class	IP20	
kA Rating (J Fuse)	14kA	

†Note: Two 115 A Feeder Terminals required per phase

Ordering Data

No. of Poles	No. of Devices	No. of Pins	Description	Part Number
1-Pole	12	12	MCB BUS BAR UL489 1 POLE 12 PIN	BRBB112
	18	18	MCB BUS BAR UL489 1 POLE 18 PIN	BRBB118
	57	57	MCB BUS BAR UL489 1 POLE 57 PIN	BRBB157
2-Pole	6	12	MCB BUS BAR UL489 2 POLE 12 PIN	BRBB212
	9	18	MCB BUS BAR UL489 2 POLE 18 PIN	BRBB218
	28	56	MCB BUS BAR UL489 2 POLE 56 PIN	BRBB256
3-Pole	4	12	MCB BUS BAR UL489 3 POLE 12 PIN	BRBB312
	6	18	MCB BUS BAR UL489 3 POLE 18 PIN	BRBB318
	19	57	MCB BUS BAR UL489 3 POLE 57 PIN	BRBB357
*1-Pole with Auxiliary Module Spacing	37	37	MCB BUS BAR UL489 1 POLE 37 PIN AUX	BRBB137A
**2-Pole with Auxiliary Module Spacing	23	46	MCB BUS BAR UL489 2 POLE 46 PIN AUX	BRBB246A
***3-Pole with Auxiliary Module Spacing	16	48	MCB BUS BAR UL489 3 POLE 48 PIN AUX	BRBB348A

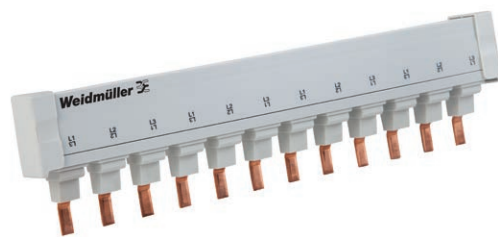

Feeder Terminal



Bottom/Direct Feeder Terminal



Endcap



Protective Cap



Lock-on, Lock-off Device

Accessories for Busbars UL 489

Description	Part Number
Feeder Terminal, UL 489, 115 A	BRBBPWR35

Description	Part Number
Bottom/Direct Feeder Terminal, UL 489, 115 A	BRBBPWR50

Description	Part Number
Endcap for UL 489 Cutable Busbar	BRBBECAP

Description	Part Number
Protective Cap for UL 489 cuttable busbar, 3 caps per bar	BRBBPCAP

Description	Part Number
Lock-on, Lock-off Device	LD10

Busbars UL 1077 – cuttable

Description

Busbars for the connection of circuit breakers type SUxxxUC to UL 1077. The busbars of 1 meter length can individually be cut to a suitable length for the application and isolated with end caps. Depending on the control cabinet design, the supply is by means of supply terminals without increasing the installation width or by means of a terminal block directly on the rail without increasing the installation height.

Three busbar models are available for use with auxiliary contact modules with a width of 9 mm.

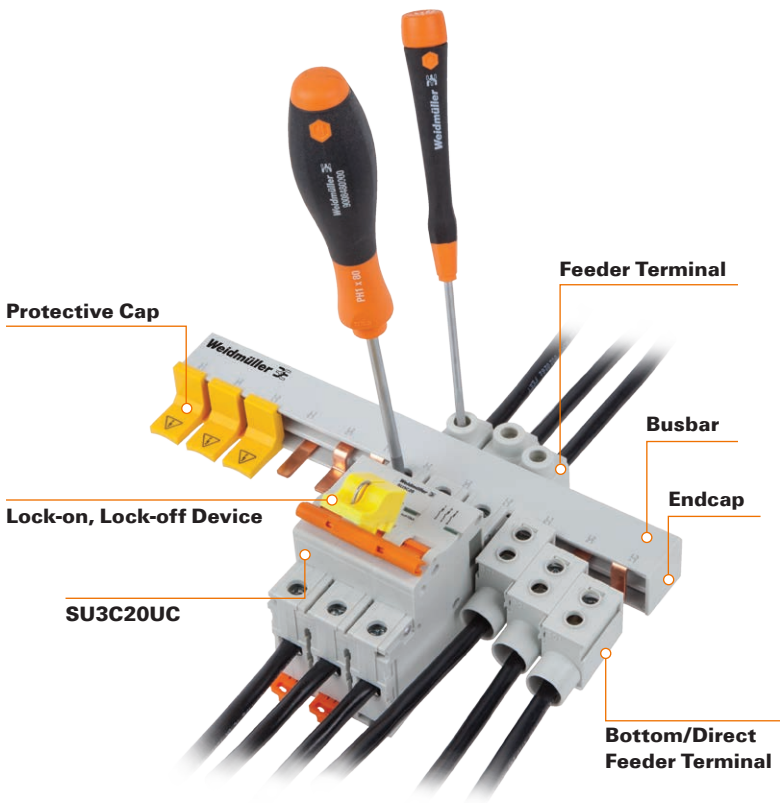

How to prepare the cuttable busbar

1. Use a saw to cut the busbar to the desired length



2. Slide the copper bars from the insulation and cut back the bars for proper end clearances



3. Deburr the edges

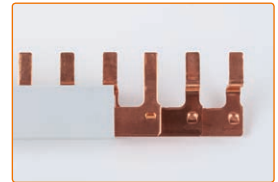

4. Use a stiff brush or compressed air to remove any copper or plastic filings and reassemble the busbar

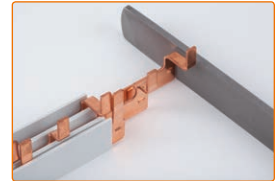

5. Attach endcaps
Note: For safety purposes, all shortened busbars need to be covered with suitable endcaps

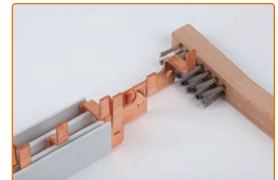

Technical Data

Voltage Ratings	Single Phase	2 and 3 Phase
Max. AC Voltage	1000 V AC	600 V AC
Max. DC Voltage	1000 V DC	600 V DC
Current Ratings	End Feed	Center Feed
Max. Current 18 mm ² Cross Section	80 A	160 A†
Protection Class	IP20	
kA Rating (J Fuse)	14kA	

†Note: Two 115 A Feeder Terminals required per phase

Ordering Data

No. of Poles	No. of Devices	No. of Pins	Description	Part Number
1-Pole	12	12	MCB BUS BAR UL1077 1 POLE 12 PIN	SB112
	18	18	MCB BUS BAR UL1077 1 POLE 18 PIN	SB118
	57	57	MCB BUS BAR UL1077 1 POLE 57 PIN	SB157
2-Pole	6	12	MCB BUS BAR UL1077 2 POLE 12 PIN	SB212
	9	18	MCB BUS BAR UL1077 2 POLE 18 PIN	SB218
	28	56	MCB BUS BAR UL1077 2 POLE 56 PIN	SB256
3-Pole	4	12	MCB BUS BAR UL1077 3 POLE 12 PIN	SB312
	6	18	MCB BUS BAR UL1077 3 POLE 18 PIN	SB318
	19	57	MCB BUS BAR UL1077 3 POLE 57 PIN	SB357
1-Pole with Auxiliary Module Spacing	37	37	MCB BUS BAR UL1077 1 POLE 37 PIN AUX	SB1A37
2-Pole with Auxiliary Module Spacing	23	46	MCB BUS BAR UL1077 2 POLE 46 PIN AUX	SB2A46
3-Pole with Auxiliary Module Spacing	16	48	MCB BUS BAR UL1077 3 POLE 48 PIN AUX	SB3A48

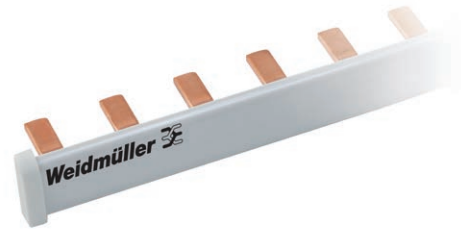

1P Top Feed Terminal



2/3P Top Feed Terminal



Bottom/Direct Feeder Terminal

Top Feed Terminal

Description	Part Number
MCB BUS BAR UL1077 1P TERM TOP FEED	SPF351P
MCB BUS BAR UL1077 2/3P TERM TOP FEED	SPF35

Bottom/Direct Feeder Terminal

Description	Part Number
MCB BUS BAR UL1077 1/2/3P TERM BOT FEED	SPF50

Endcap

Description	Part Number
MCB BUS BAR UL1077 1P END CAP	SEC1P
MCB BUS BAR UL1077 2/3P END CAP	SECMP



Endcap

Protective Cap

Description	Part Number
MCB BUS BAR UL1077 BUS CAP YEL (5 caps)	STPC



Protective Cap

Lock-on, Lock-off Device

Description	Part Number
Lock-on, Lock-off Device	LD10

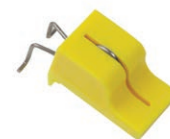

Lock-on, Lock-off Device

Terms

Weidmuller UC Series breakers are UL tested and certified as current limiting protective devices. Current limiting circuit breakers provide a higher level of circuit protection than a typical zero point external breakers.

Ampere Rating

A rating of the amount of current a protective device will carry continuously without deteriorating or exceeding temperature rise limits.

Arc

The effect generated when electrical current bridges the air gap between two conductors that are not touching.

Branch Circuit

The conductor and components following the last over-current protective device protecting a load.

Circuit Breaker

A device designed to open and close a circuit by non-automatic means, and to open the circuit automatically on a pre-determined overcurrent, without damage to itself when properly applied within its rating.

Current Limiting

A type of supplementary protector which limits the amount of damaging short circuit current.

DIN-Rail

A solidly mounted, rail-type device to which any number of circuit breakers can be mounted.

Double Pole

Term used to describe a breaker that draws power from two poles of a load center or similar device.

Frame

A component of a miniature circuit breaker. Its primary function is to provide a rigid, mechanically strong, insulated housing in which the other components are mounted.

IEC

Abbreviation for International Electrotechnical Commission. This organization is associated with equipment used internationally.

IEC 60947-2 Current Limiting Circuit Breaker

A circuit breaker with sufficiently short trip time to prevent the short circuit current from reaching the peak value which would otherwise be reached.

Interrupting Rating

The highest current, at rated voltage, that a device is intended to interrupt under standard test conditions.

Let-through Current

The maximum instantaneous or peak current which passes through a protective device.

Load Center

A device that delivers electricity from a supply source to loads in light commercial or residential applications.

Miniature Circuit Breaker (MCB)

A specific type of circuit breaker, used to switch and protect the lowest common distribution voltage in an electrical system. Generally used in a load center, panelboard or similar device.

NEC

Abbreviation for National Electrical Code. A standard for applying electrical equipment in the United States.

NEC240.2 Current Limiting

A device that, when interrupting current in its current-limiting range, reduces the current flowing in the faulted circuit to a magnitude substantially less than that obtainable in the same circuit if the device were replaced with a solid conductor having comparable impedance.

Operating Mechanism

A component of a miniature circuit breaker. Its function is to provide the means of opening and closing the circuit.

Overcurrent Protective Device

A device such as a circuit breaker or fuse. In the event of an overload or short circuit, this device will quickly terminate power to the circuit.

Overload (or Overcurrent)

A condition in which current is in excess of the normal load being drawn.

Short Circuit

An electrical fault created when two exposed conductors touch.

Single Pole

Term used to describe a breaker that draws power from one pole of a load center or similar device.

Supplementary Protector

A device similar in function to a miniature circuit breaker, but not UL approved as a circuit breaker. Used in conjunction with circuit breakers.

Thermal Magnetic

The predominant trip unit technology used in the domestic market. A bimetal and an electromagnet work together to provide overload and short circuit protection.

UL AC 60Hz Cycle

UL defines an AC cycle as the potential energy of the wave form traveling from Zero-to-Positive amplitude, Positive-to-Zero amplitude, Zero-to-Negative amplitude, Negative-to-Zero amplitude 60 times in one second. One cycle is completed every 16.6 milliseconds.

UL Breaker Current Limiting

UL defines breaker current limitation as a breaker that interrupts and isolates a fault in less than half of an AC cycle. Half a cycle is completed in 8.3 milliseconds.

Withstand Rating

The maximum current that an unprotected electrical component can sustain for a specific period of time without the occurrence of extensive damage.

Additional Technical Information

Operation and Components of BR/SUxxxUC MCBs

During normal operation and the MCB switch engaged, current flows in the line side terminal to a bimetallic strip, moving contact, fixed contact, current coil (magnetic trip coil) and out the load side terminal to complete a series path.

The MCB enclosure housing is a molded plastic material. This provides mechanical strength and insulation from the components inside. The switching system consists of a fixed and a moving contact plate to which incoming and outgoing conductors are connected. The current carrying components are made up of various metallic compounds depending on the rating of the circuit breaker.

The orange lever is used to manually engage/disengage the contact under normal ON/OFF conditions, as well as indicate status of the device. It also allows manual RESET of the latch after an overload or short circuit event.

The thermal overload configuration for the slow rising current over time consists of a strip of bimetal (two dissimilar metals). The rise in current causes a rise in temperature. The heat generated within the bimetal itself is enough to cause deflection due to thermal expansion of the dissimilar metals. This deflection further releases the trip latch mechanism and the contact faces separate.

The magnetic tripping configuration for short circuit conditions consists of a system that allow fast rise time current (too fast for the bimetal) to separate the contact faces using a spring loaded plunger. The current carrying coil in this trip configuration moves the plunger when a strong magnetic field produced by the coils releasing the plunger engaging the trip latch mechanism.

From the action of the fixed and moving contact faces separating in the event of an overload or short circuit situation, an electric arc in air is formed. The UC Series is designed to handle the arc interruption process where arc energy extraction and its cooling are provided by the arc runner and parallel arc splitter plates called the arc chute. These plates are held in position by the housing material. The operating mechanism consists of both magnetic tripping and thermal tripping arrangements.

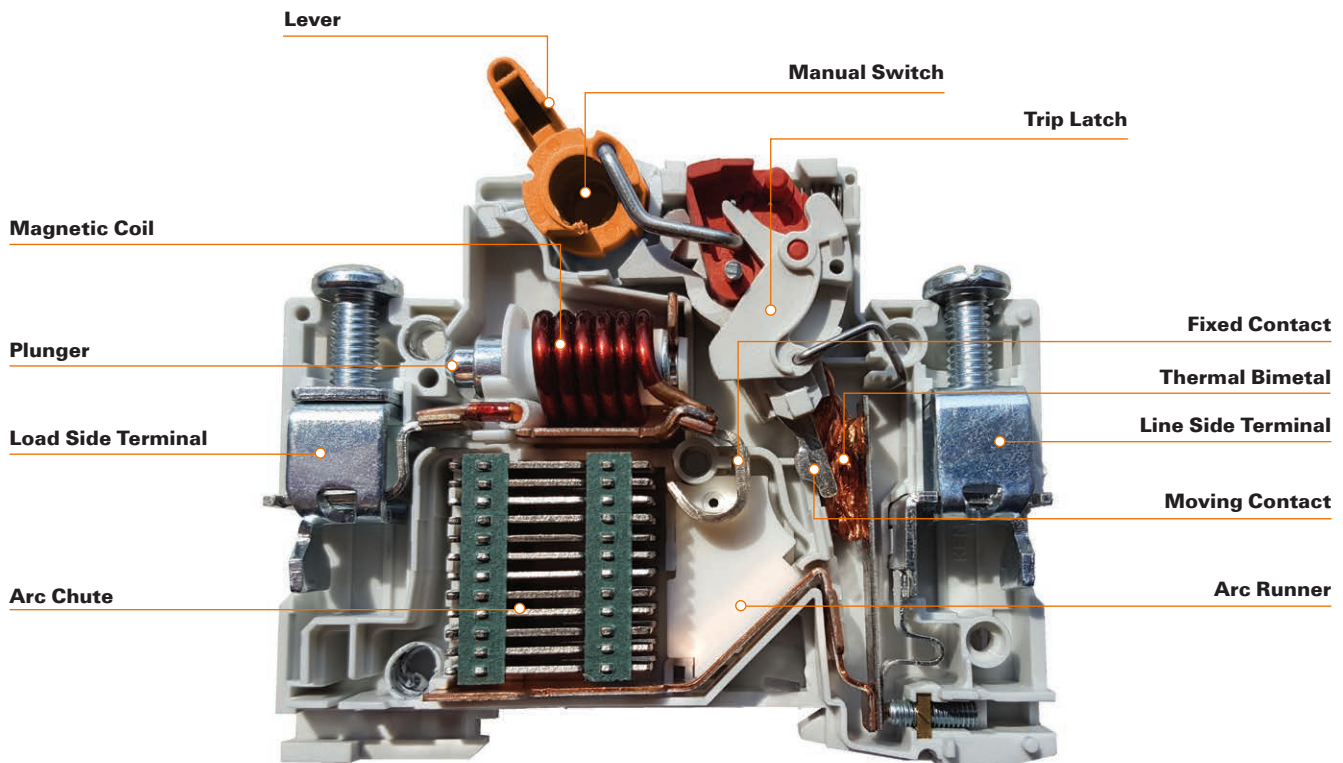

Weidmüller UC Series Thermal Magnetic Definition

Thermal Overload

A thermal overload is a slow and small overcurrent situation that causes the ampacity and temperature of the circuit to gradually increase. This type of event is characterized by a slight increase in the load (ampacity) on the circuit and is interrupted by the thermal trip unit of the breaker.

Thermal Region of the trip curve representing the tripping characteristics of the bimetal trip unit. The tripping region is sloped due to the gradual overload, heating, and bending nature of the thermal element over time.

Short Circuit

A short circuit is an intense overcurrent situation that causes the ampacity of the circuit to increase. This type of event is characterized by a dramatic increase in the load (ampacity) on the circuit and is interrupted by the magnetic trip unit of the breaker.

Magnetic Region of the trip curve representing the tripping characteristics of the magnetic trip unit. The tripping region is not sloped due to the instantaneous nature of the magnetic element during a short circuit.

MCBs' tripping characteristics are represented graphically in a trip curve chart. The chart shows the response of the thermal and magnetic trip element to various overload and short circuit situations.

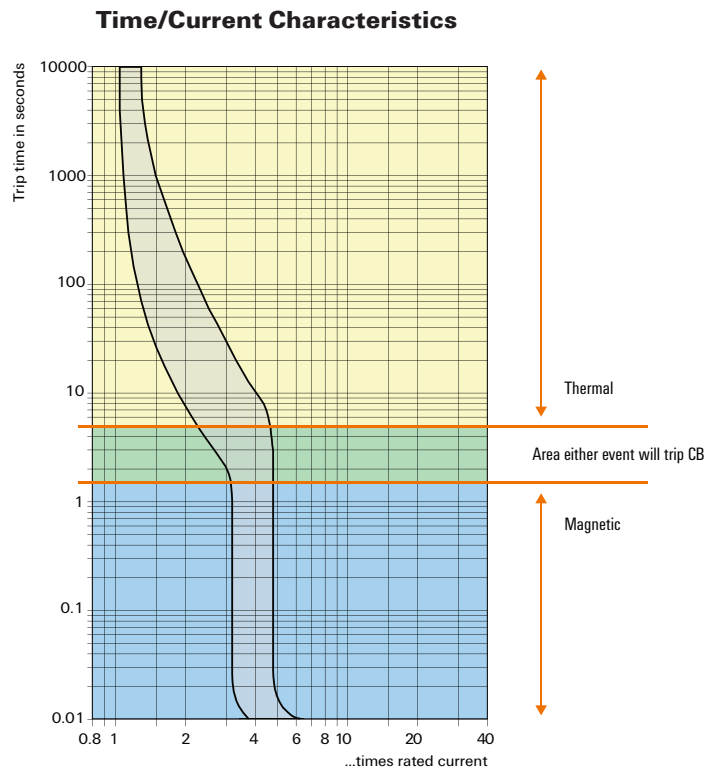

Examples of Trip Curve Interpretation

Reading Trip Curves

Example 1: Thermal Tripping Characteristic

10 Amp B Curve Breaker Thermal Overload at 20 Amps

To determine the time it takes for the breaker to trip with a 20 A load:

- Find 20 A on the bottom of the curve – 10 A breaker at 2X current is 20 A
- Follow the ampacity line up to the “time” tripping region of the curve.

The breaker will trip under a thermal overload in the area between where 20 A intersects the bottom curve line and the intersection of the top curve. The breaker is guaranteed to trip in this time bandwidth.

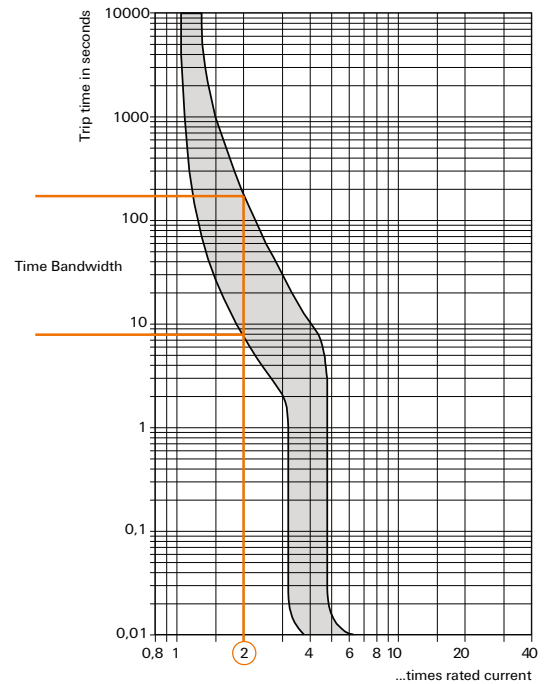

Example 2: Magnetic Tripping Characteristic

10 Amp B Curve Breaker Short Circuit at 70 Amps

To determine the time it takes for the breaker to trip with a 70 A short circuit:

- Find 70 A on the bottom of the curve – 10 A breaker at 7X current is 70 A
- Notice the “time” at the bottom left corner of the chart axis.

The breaker is guaranteed to trip no later than .01 seconds for any short circuit equal to 70 A.

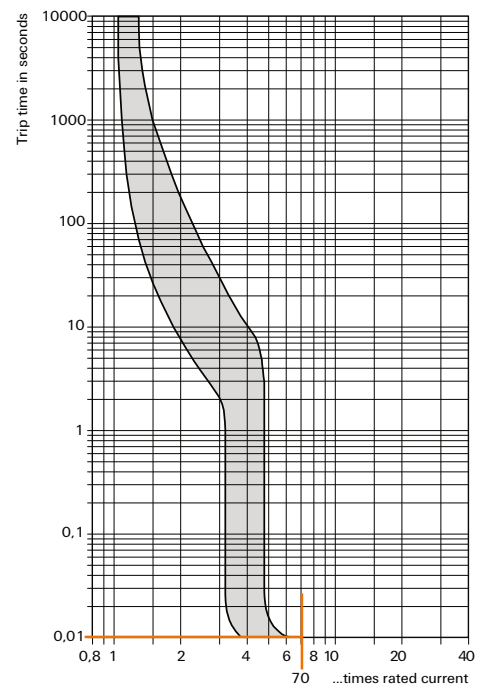

Ambient Temperature Derating

Maximum operating currents depending on ambient temperature

Rated current I_N (A)	Max. operating currents depending on ambient temperature T (A)										
	-35°C	-30°C	-25°C	-20°C	-15°C	-10°C	-5°C	0°C	+5°C	+10°C	+15°C
1	1.27	1.25	1.23	1.21	1.19	1.17	1.15	1.13	1.10	1.08	1.06
2	2.87	2.81	2.74	2.68	2.62	2.55	2.48	2.42	2.35	2.28	2.20
3	3.89	3.83	3.76	3.70	3.64	3.57	3.50	3.44	3.37	3.30	3.22
4	4.91	4.83	4.76	4.70	4.64	4.57	4.50	4.44	4.37	4.30	4.22
5	6.68	6.56	6.44	6.32	6.19	6.07	5.94	5.81	5.68	5.54	5.40
6	7.70	7.58	7.46	7.34	7.21	7.09	6.96	6.83	6.70	6.56	6.42
7	8.78	8.66	8.54	8.42	8.29	8.17	8.04	7.91	7.78	7.64	7.50
8	9.80	9.68	9.56	9.44	9.31	9.19	9.06	8.93	8.80	8.66	8.52
10	13.89	13.62	13.35	13.07	12.81	12.53	12.23	11.93	11.63	11.33	11.01
12	15.91	15.64	15.37	15.09	14.83	14.55	14.25	13.95	13.65	13.35	13.03
13	16.92	16.65	16.38	16.10	15.84	15.56	15.26	14.96	14.66	14.36	14.04
15	19.77	19.42	19.07	18.74	18.39	18.04	17.69	17.32	16.95	16.57	16.19
16	20.78	20.43	20.08	19.75	19.40	19.05	18.70	18.33	17.96	17.58	17.20
20	25.67	25.28	24.88	24.47	24.06	23.64	23.22	22.78	22.34	21.89	21.43
25	32.21	31.72	31.22	30.70	30.18	29.65	29.10	28.55	27.98	27.41	26.82
30	39.00	38.42	37.78	37.13	36.47	35.80	35.11	34.43	33.71	32.99	32.26
32	41.04	40.46	39.82	39.17	38.51	37.84	37.15	36.47	35.75	35.03	34.30
35	44.08	43.50	42.86	42.21	41.55	40.88	40.19	39.51	38.79	38.07	37.34
40	51.63	50.86	50.04	49.21	48.37	47.51	46.63	45.74	44.83	43.90	42.95
50	64.92	63.97	62.92	61.86	60.77	59.67	58.54	57.40	56.23	55.05	53.81
60	80.45	79.03	77.61	76.16	74.69	73.19	71.67	70.11	68.51	66.88	65.21
63	83.48	82.06	80.71	79.19	77.72	76.22	74.70	73.14	71.54	69.91	68.24

Rated current I_N (A)	Max. operating currents depending on ambient temperature T (A)										
	+20°C	+25°C	+30°C	+35°C	+40°C	+45°C	+50°C	+55°C	+60°C	+65°C	+70°C
1	1.05	1.02	1.00	0.97	0.94	0.91	0.89	0.86	0.83	0.80	0.77
2	2.12	2.04	2.00	1.90	1.82	1.74	1.65	1.56	1.47	1.36	1.25
3	3.14	3.06	3.00	2.92	2.84	2.76	2.67	2.58	2.49	2.38	2.27
4	4.14	4.06	4.00	3.92	3.84	3.76	3.67	3.58	3.49	3.38	3.27
5	5.25	5.12	5.00	4.82	4.66	4.50	4.34	4.17	3.99	3.81	3.62
6	6.27	6.14	6.00	5.84	5.68	5.52	5.36	5.19	5.01	4.83	4.64
7	7.35	7.22	7.00	6.92	6.76	6.60	6.44	6.27	6.09	5.91	5.72
8	8.37	8.24	8.00	7.94	7.78	7.62	7.46	7.29	7.11	6.93	6.74
10	10.67	10.34	10.00	9.63	9.24	8.85	8.45	8.01	7.55	7.06	6.55
12	12.69	12.36	12.00	11.65	11.26	10.80	10.47	10.03	9.57	9.08	8.57
13	13.70	13.37	13.00	12.66	12.27	11.81	11.48	11.04	10.58	10.09	9.58
15	15.79	15.39	15.00	14.54	14.10	13.65	13.19	12.70	12.20	11.69	11.64
16	16.80	16.40	16.00	15.55	15.11	14.66	14.20	13.71	13.21	12.70	12.65
20	20.96	20.47	20.00	19.47	18.95	18.42	17.87	17.30	16.71	16.10	15.47
25	26.22	25.61	25.00	24.33	23.67	23.00	22.28	21.56	20.80	20.02	19.21
30	31.50	30.73	30.00	29.13	28.30	27.44	26.56	25.65	24.71	23.74	22.73
32	33.54	32.77	32.00	31.17	30.34	29.48	28.69	27.69	26.75	25.78	24.77
35	36.58	35.81	35.00	34.21	33.38	32.52	31.64	30.73	29.79	28.82	27.81
40	41.98	40.99	40.00	38.93	37.85	36.75	35.61	34.43	33.21	31.95	30.63
50	52.56	51.28	50.00	47.82	46.24	44.81	43.33	41.81	40.23	38.58	35.77
60	63.50	61.75	60.00	57.08	55.16	53.18	51.13	49.00	46.78	44.47	40.47
63	66.53	64.78	63.00	60.11	58.19	56.21	54.16	52.03	49.81	47.50	43.50

UC Series D Curve Thermal Magnetic Tripping Characteristics vs K Curve

The K and UC Series D curve breakers are both designed for motor applications where ampacity rises quickly and momentarily during "start-up". Both curves can "ride through" the momentary inrush of current and prevent nuisance tripping while providing protection to the circuit.

Both curves have almost identical tripping characteristics. The magnetic element tripping characteristics are identical between the two curves and the thermal element tripping characteristics have a slight variation.

Thermal Tripping Characteristics Comparison

Example:

10 Amp D Curve Breaker

Thermal Overload at 20 Amps

To determine the time it takes for the breaker to trip with a 20 A load:

- Find 20 A on the bottom of the curve – 10 A breaker at 2X current is 20 A
- Follow the ampacity line up to the "time" tripping region of the curve.

The breaker will trip under a thermal overload in the area between where 20 A intersects the bottom curve line (~7.5s) and the intersection of the top curve (~150s). The breaker is guaranteed to trip in this time bandwidth.

D Curve

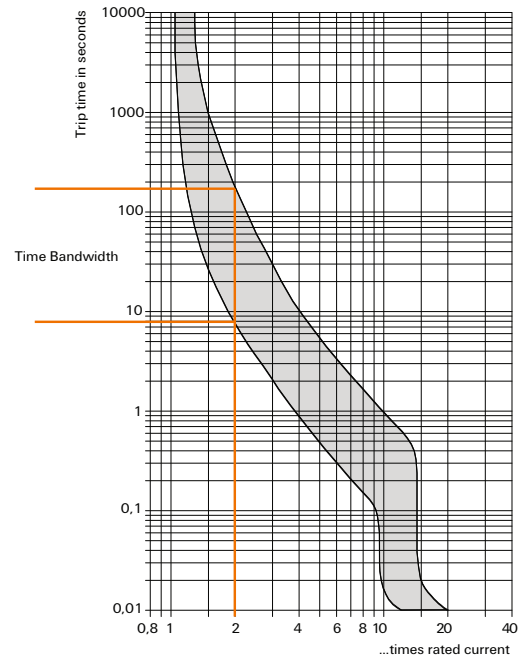

Similarly the K curve breaker will trip under a thermal overload between 6 and 350 seconds. The breaker is guaranteed to not trip before ~6 seconds and will not take longer than ~350 seconds to trip. The breaker may trip at any time in this time bandwidth.

K Curve

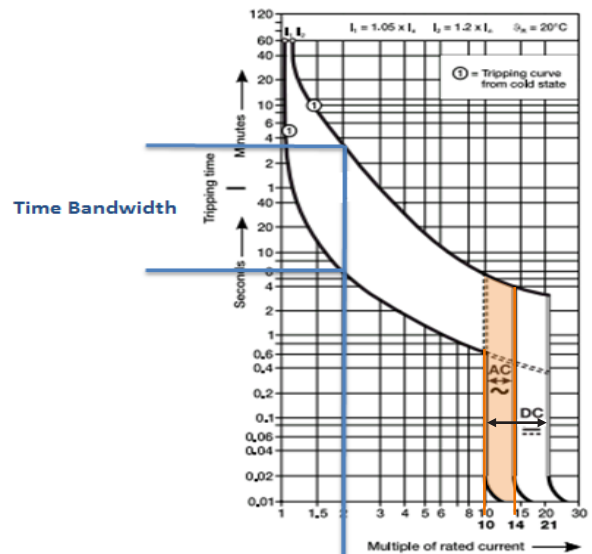

Short Circuit Tripping Characteristics Comparison

**Example:
10 Amp K Curve Breaker and UC Series 10 Amp
D Curve Breaker
Short Circuit at 100 Amps**

Both breakers have an element that will trip between 10 and 14 times rated current. Both breakers will trip under a short circuit before .01 seconds. And both breakers are guaranteed to trip no later than .01 seconds for any short circuit equal to 100 A or greater.

K and UC Series D Curve Summary

Thermal Element Minimum Tripping

The UC Series D curve MCB will interrupt an overload at 2X rated current in 7.5s or greater. The K curve MCB will interrupt an overload at 2X rated current in 6 seconds or greater. This additional time allows a circuit more time to “ride through” high inrush at start-up and prevent nuisance tripping.

Thermal Element Bandwidth

The K curve tripping bandwidth at 2X rated current is between 6 and 350 seconds. The UC Series D curve tripping bandwidth at 2X rated current is between 7.5 and 150 seconds. The differences between the bandwidths demonstrate calibration and quality control accuracy. The UC Series D curve breaker from Weidmuller has a much smaller tolerance bandwidth and requires a higher level of adjustment during manufacturing and quality control validation.

Magnetic Element

The magnetic element of the K curve and UC Series D curve MCBs are identical. Both breakers interrupt a short circuit at 10X the rated current (or greater) in no later than .01 seconds.

D Curve

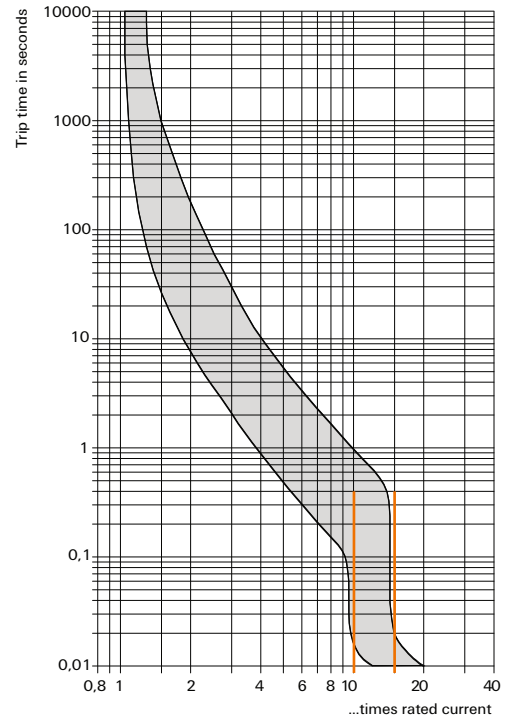

K Curve

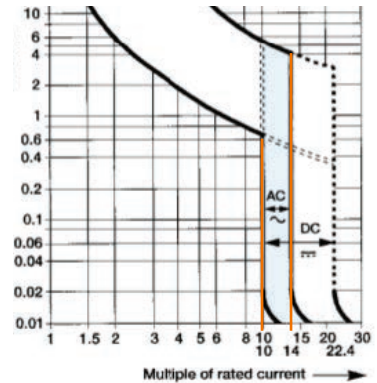

Additional Weidmuller Offerings

CB4200 Series Circuit Breakers Thermal Magnetic Type

- Rated from 0.05 to 16.0 amps
- Available in single or double pole configurations
- Features a tease free design to reduce contact damage
- Offers push button trip/reset function
- Trip free design means the breaker cannot be held closed against a fault
- Mounts on 32 mm⁺ or 35 mm DIN-rail
- UL 1077 recognized
- CSA C22.2 No. 235



Single Pole

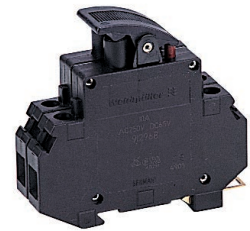

Double Pole

Technical Data

Voltage rating and current [†]	UL	AC 250 V, DC 65 V, 50/60 Hz 0.05...16 A	
	CSA	AC 250 V, DC 65 V, 50/60 Hz 0.05...16 A	
	VDE	AC 250 V, DC 65 V, 50/60 Hz 0.05...16 A	
Creepage resistance	PTI 600 to IEC 112		
Dielectric strength	4,000 VAC; IEC 664 & 664 A		
Insulation resistance	> 100 MM (DC 500 V)		
Interrupting capacity (VDE 0660, Part 101, P-2)	4201-10	Maximum capacity	
	0.05...0.8 A	Self-limiting	
	1...2 A	200 A	
	2.5...16 A	400 A	
Interrupting capacity 4201 (UL 1077/EN 60934 PC1)	Rated current	Rated voltage	Maximum capacity
	0.05...2.0 A	AC 250 V	200 A
	2.0...16 A	AC 250 V	200 A
	20 A	AC 125 V	400 A
Typical life at 2 x rated current	5,000 operations		
Shock	25g (11 ms) to IEC 68-2-27, Test Ea		
Torque	1.2 Nm		
Vibration	5g (57 to 500 Hz / ±0.38 mm, 10 to 57 Hz) to IEC 68-2-6, Test Fc		
Temperature range	-30°C...+55°C (-22°F...+131°F)		
Corrosion	96 hours at 5% salt spray, to IEC 68-2-11, Test Ka		
Humidity	240 hours at 95% RH, to IEC 68-2-3, Test Ca		
Weight	60 g per pole		
Wire size (UL)	#20...8 AWG solid/0.5...6 mm ²		

[†]Note: Resistive and inductive loads (0.05 - 16 A)

Trip Curves Thermal Magnetic Type Typical time/current characteristics at 23°C

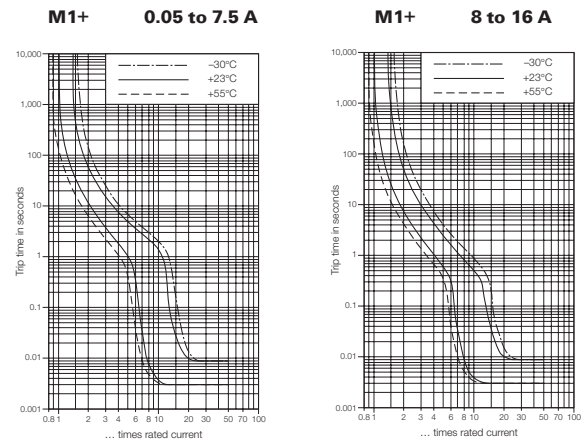

‡ Adapter foot – dimensions in mm (in.)

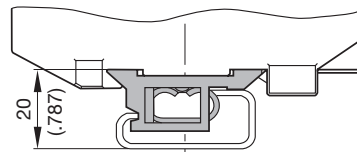

9102100000
TS32 adapter

Ordering Data

Current Ratings (amps)	Single Pole	Double Pole
	Part No. TS 35 *For TS 32 Rail, see adapter	Part No. TS 35 *For TS 32 Rail, see adapter
0.05	9124083500	9124223500
0.08	9124653500	9124233500
0.1	9104173500	9120353500
0.2	9104183500	9124243500
0.3	9129813500	9124263500
0.4	9124093500	9124273500
0.5	9101003500	9129583500
0.6	9124113500	9124283500
0.7	9129563500	9124293500
0.8	9101103500	9129593500
1.0	9101203500	9129613500
1.2	9101303500	9129623500
1.3	9124123500	9124313500
1.4	9124133500	9124323500
1.5	9101403500	9129633500
1.8	9124143500	9124333500
2.0	9101503500	9129643500
2.5	9101603500	9129653500
3.0	9101703500	9129663500
3.5	9124163500	9124343500
4.0	9104353500	9129713500
4.5	9124173500	9124353500
5.0	9101803500	9129673500
5.5	9107833500	9124363500
6.0	9103813500	9124373500
6.5	9120043500	9124383500
7.0	9104153500	9124393500
8.0	9103003500	9104673500
9.0	9104613500	9124423500
10.0	9101903500	9129683500
11.0	9124183500	9124433500
12.0	9107843500	9124443500
13.0	9124193500	9124453500
14.0	9107853500	9124463500
15.0	9102003500	9129693500
16.0	9124213500	9124473500

Accessories	Type	Part No.
Jumpers	Daisy Chain 50*	BDC 50 9970290000
		CQB 2 9970560000
	Straight CQB** insulated	CQB 3 9970570000
		CQB 4 9970580000
		CQB 10 9970590000
Angled CQB** insulated	CQB 2 9970600000	
	CQB 3 9970610000	
	CQB 4 9970620000	
	CQB 10 9970630000	
Adapter foot (for TS 32 Rail)	MCB AF/TS 32	9102100000
Busbar	Single pole 1 meter	6720000227
Busbar end cap for 6720000227		6720000225
Power lug for 6720000227		6720000226

Marking Tags	Type	Part No.
Note: Part numbers are shown for a single card of pre-printed tags numbered 1-50.	Special print only	WS 8/5 MC 1640750000***
	Consecutive horizontal	DEK 5/5 0473460001
	Consecutive vertical	DEK 5/5 0473560001

Single Pole

Dimensions

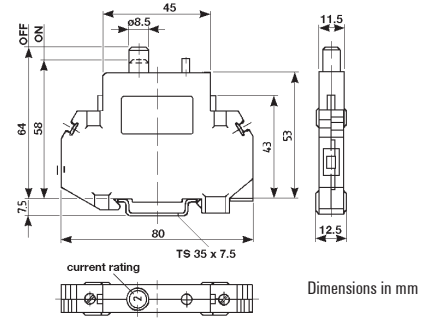

Schematic Diagrams

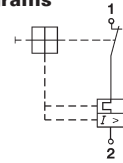

Double Pole

Dimensions

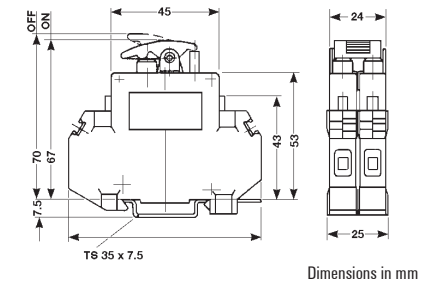

Schematic Diagrams

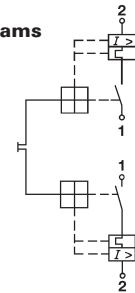

*BDC will accommodate 20 A per pin, 20 A total
 **CQB will accommodate 18 A per pin, 18 A total; dedicated to 4201 Series
 ***Please specify horizontal or vertical print when ordering. Standard quantity = 144 tags per card.

Weidmuller Catalogs at a Glance

Catalog 1: Modular Terminal Blocks

- P-Series (Push-in)
- I-Series (IDC)
- Power Distribution Blocks and Fuse Blocks
- Stud Style (Screw clamp)
- Z-Series (Tension clamp)
- W-Series (Screw clamp)
- Multi-function Blocks

Catalog 2: PCB Terminals and Connectors

- Space Saving Technologies
- Wide Variety of Clamping Technologies
- Pitches Ranging from 3.50 mm to 15.00 mm
- Orientations Ranging from 90° to 270°

Catalog 3: RockStar® – Heavy Duty Connectors

- Inserts
- Modular System
- Housings IP65 and IP68
- Cable Glands

Catalog 4.1: Analog Signal Conditioning

- Intrinsically Safe Conditioners
- Signal Converters and Monitoring Devices
- Indicators and Configurable Displays
- Fieldbus Distribution Boxes

Catalog 4.2: Relays and Optocouplers

- Mechanical Relays
- Solid-State (Opto) Relays
- Power Solid-State Relays
- Multifunction Relays and Timers

Catalog 4.3: Power Delivery

- Power Supplies
- UPS Control Units
- Battery Back Up Units

Catalog 4.4: Surge Protection

- Surge Protection for Low-Voltage
- Surge Protection for Instrumentation and Control
- Surge Protection for Data Interfaces
- Surge Protection for Photovoltaic Systems

Catalog 5: Enclosures and Cable Glands

- Enclosures
- Cable Glands
- Cabtite (Cable Entry System)

Catalog 6: Tools

- Cutting
- Stripping
- Crimping
- Screwdrivers
- Automatic Machines
- Ferrules

Catalog 7: Marking Systems

- Terminal Markers
- Wire and Cable Markers
- Device and Equipment Markers
- Printing Systems and Software

Catalog 8: Sensor Actuator Interface

- SAI Passive Blocks
- SAI Universal
- SAI ASI
- Cables and Connectors

Catalog 9: Industrial Ethernet

- Unmanaged Switches
- Managed Switches
- Routers
- Media Converters
- SteadyTEC®
- RJ45 Connectors
- Fiber Optic Connectors
- Accessories

Catalog 10: Short Form Catalog

- Terminal Blocks
- Enclosures and Cable Glands
- Professional Tools
- Heavy Duty Connectors
- Power Supplies and Breakers
- Relays and Optos
- Analog Signal Conditioning
- Wireless and Ethernet

Catalog 11: Circuit and Surge Protection

- Surge Protection for Low Voltage
- Surge Protection for Instrumentation and Control
- Circuit Breakers and Protectors
- DIN-mountable AC Receptacles (DRAC)

Catalog 12: Wireless I/O and Ethernet Connectivity

- Wireless I/O and Ethernet
- Wireless Gateways
- Wireless Transceivers
- Antennas and Accessories

Catalog u-remote: Distributed I/O Solutions

- Field Bus Couplers
- Digital Input and Output Modules
- Analog Input and Output Modules
- Power Feed-in Modules
- Temperature Modules
- Functional Safety Modules

Weidmuller – Your partner in Industrial Connectivity

As experienced experts we support our customers and partners around the world with products, solutions and services in the industrial environment of power, signal and data. We are at home in their industries and markets and know the technological challenges of tomorrow. We are therefore continuously developing innovative, sustainable and useful solutions for their individual needs. Together we set standards in Industrial Connectivity.



Visit our BR/SUxxxUC Series Circuit Breakers website page for more information:
www.weidmuller.com/BRSUxxxUCSeries

Weidmuller, Canada

10 Spy Court
Markham, Ontario L3R 5H6
Telephone: (800) 268-4080
Facsimile: (877) 300-5635
Email: info1@weidmuller.ca
Website: www.weidmuller.ca

Weidmuller, Mexico

Bldv. Hermanos Serdán 698,
Col. San Rafael Oriente
Puebla, Puebla, Mexico
C.P. 72029
Telephone: 01 222 2686267
Facsimile: 01 222 2686219
Email: clientes@weidmuller.com.mx
Website: www.weidmuller.com.mx

Weidmuller, United States

821 Southlake Blvd.
Richmond, Virginia 23236
Telephone: (800) 849-9343
Facsimile: (804) 379-2593
Email: info@weidmuller.com
Website: www.weidmuller.com