

BFP780

High linearity RF medium power transistor



Product description

The BFP780 is a single stage high linearity and high gain driver amplifier based on NPN silicon germanium technology.



Feature list

- High maximum RF input power $P_{RFIn,max} = 20$ dBm
- Minimum noise figure $NF_{min} = 1.2$ dB at 900 MHz, 5 V, 30 mA
- $OIP_3 = 34.5$ dBm at 900 MHz, 5 V, 90 mA
- $OP_{1dB} = 23$ dBm at 900 MHz, 5 V, 90 mA

Product validation

Qualified for industrial applications according to the relevant tests of JEDEC47/20/22.

Potential applications

- Commercial and industrial wireless infrastructure
- ISM band medium power amplifiers and drivers
- Automated test equipment
- UHF television, CATV and DBS

Device information

Table 1 Part information

Product name / Ordering code	Package	Pin configuration				Marking	Pieces / Reel
BFP780 / BFP780H6327XTSA1	SOT343	1 = B	2 = E	3 = C	4 = E	R1s	3000

Attention: *ESD (Electrostatic discharge) sensitive device, observe handling precautions*

Table of contents

	Product description	1
	Feature list	1
	Product validation	1
	Potential applications	1
	Device information	1
	Table of contents	2
1	Absolute maximum ratings	3
2	Recommended operating conditions	4
3	Thermal characteristics	5
4	Electrical performance in test fixture	6
4.1	DC parameter table	6
4.2	AC parameter tables	6
4.3	Characteristic DC diagrams	9
4.4	Characteristic AC diagrams	11
5	Package information SOT343	18
	Revision history	19
	Disclaimer	20

Absolute maximum ratings

1 Absolute maximum ratings

Table 2 Absolute maximum ratings at $T_A = 25\text{ °C}$ (unless otherwise specified)

Parameter	Symbol	Values		Unit	Note or test condition
		Min.	Max.		
Collector emitter voltage	V_{CE}	-	6.1 5.1	V	$T_A = 25\text{ °C}$ $T_A = -40\text{ °C}$
Collector base voltage	V_{CB}		15		-
Instantaneous total collector current	i_C		240	mA	DC + RF swing
DC collector current	I_C		120		
DC base current	I_B	-1	5		
RF input power	P_{RFIn}	-	20	dBm	In- and output matched
Dissipated power	P_{diss}		600	mW	$T_S \leq 93\text{ °C}$ ¹⁾ , regard derating curve in Figure 1 .
Junction temperature	T_J		150	°C	-
Operating case temperature	T_A	-40	105 ²⁾		
Storage temperature	T_{Stg}	-55	150		

Attention: *Stresses above the max. values listed here may cause permanent damage to the device. Exposure to absolute maximum rating conditions for extended periods may affect device reliability. Maximum ratings are absolute ratings; exceeding only one of these values may cause irreversible damage to the component.*

¹ T_S is the soldering point temperature. T_S is measured on the emitter lead at the soldering point of the PCB.
² At the same time regard $T_{J,max}$.

Recommended operating conditions

2 Recommended operating conditions

The following table shows examples of recommended operating conditions. As long as maximum ratings are regarded, operation outside these conditions is permitted, but it may increase failure rate and reduce lifetime. For further information refer to the quality report available on the BFP780 product page.

Table 3 Recommended operating conditions

Operating mode	Ambient temperature ¹⁾	Collector current	DC power ²⁾	RF output power ³⁾	Efficiency ⁴⁾	Dissipated power ⁵⁾	Thermal resistance of PCB ⁶⁾	Junction temperature ⁷⁾
	T_A [°C]	I_C [mA]	P_{DC} [mW]	P_{RFout} [mW] (dBm)	η [%]	P_{diss} [mW]	R_{thSA} [K/W]	T_J [°C]
Compression	55	90	450	200 (23)	45	250	120	110
Final stage	55	90	450	115 (20.5)	25	340	70	110
High T_A	85	50	250	75 (19)	30	175	35	110
Maximum T_A	105	20	100	45 (16.5)	45	55	35	110
Linear	55	50	250	20 (13)	8	230	120	110
Very linear	55	90	450	23 (13.5)	5	430	35	110

¹ Is the operating case temperature respectively of the heatsink.

² $P_{DC} = V_{CE} \cdot I_C$ with $V_{CE} = 5$ V.

³ RF power delivered to the load, $P_{RFout} = \eta \cdot P_{DC}$.

⁴ Efficiency of the conversion from DC power to RF power, $\eta = P_{RFout} / P_{DC}$ (collector efficiency).

⁵ $P_{diss} = P_{DC} - P_{RFout}$. The RF output power P_{RFout} delivered to the load reduces the power P_{diss} to be dissipated by the device. This means a good output match is recommended.

⁶ R_{thSA} is the thermal resistance of the PCB including heat sink, that is between the soldering point S and the ambient A. Regard the impact of R_{thSA} on the junction temperature T_J , see below. The thermal design of the PCB, respectively R_{thSA} , has to be adjusted to the intended operating mode.

⁷ $T_J = T_A + P_{diss} \cdot R_{thJA}$.

$R_{thJA} = R_{thJS} + R_{thSA}$.

R_{thJA} is the thermal resistance between the transistor junction J and the ambient A.

R_{thJS} is the combined thermal resistance of die and package, which is 95 K/W for BFP780, see [Chapter 3](#).

Thermal characteristics

3 Thermal characteristics

Table 4 Thermal resistance

Parameter	Symbol	Values			Unit	Note or test condition
		Min.	Typ.	Max.		
Junction - soldering point	R_{thJS}	-	95	-	K/W	-

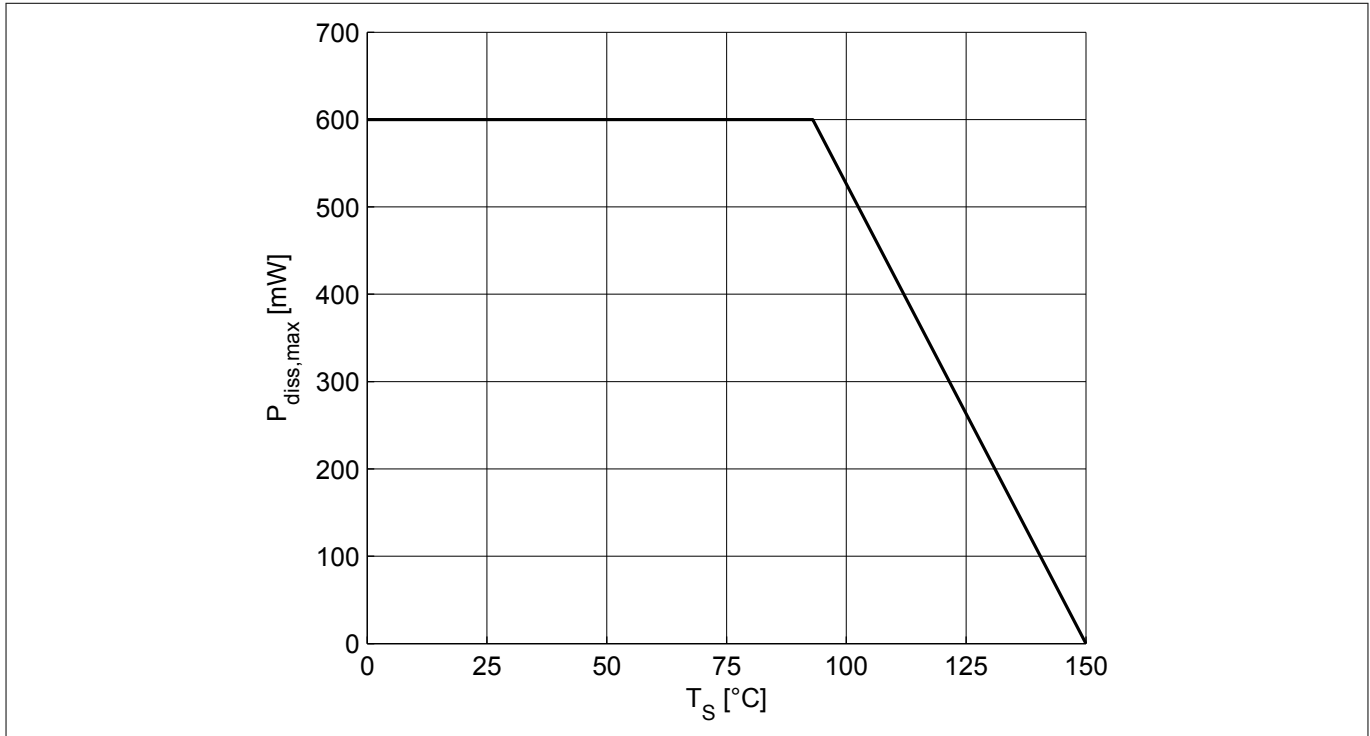

Figure 1 Absolute maximum power dissipation $P_{diss,max} = f(T_S)$

Note: In the horizontal part of the derating curve the maximum power dissipation is given by $P_{diss,max} \approx V_{CE,max} \cdot I_{C,max}$. In this part, the junction temperature T_J is lower than $T_{J,max}$. In the declining slope, it is $T_J = T_{J,max}$. $P_{diss,max}$ has to be reduced according to the curve in order not to exceed $T_{J,max}$. It is $T_{J,max} = T_S + P_{diss,max} \cdot R_{thJS}$.

Electrical performance in test fixture

4 Electrical performance in test fixture

4.1 DC parameter table

Table 5 DC characteristics at $T_A = 25\text{ °C}$

Parameter	Symbol	Values			Unit	Note or test condition
		Min.	Typ.	Max.		
Collector emitter breakdown voltage	$V_{(BR)CEO}$	6.1	6.6	–	V	$I_C = 1\text{ mA}$, open base
Collector emitter leakage current	I_{CES}	–	1 0.1	40 ¹⁾ 3 ¹⁾	nA μA	$V_{CE} = 8\text{ V}$, $V_{BE} = 0\text{ V}$, $V_{CE} = 18\text{ V}$, $V_{BE} = 0\text{ V}$, E-B short circuited
Collector base leakage current	I_{CBO}		1	40 ¹⁾	nA	$V_{CB} = 8\text{ V}$, $I_E = 0$, open emitter
Emitter base leakage current	I_{EBO}		–	10 ¹⁾	μA	$V_{EB} = 0.5\text{ V}$, $I_C = 0$, open collector
DC current gain	h_{FE}	85	160	230		$V_{CE} = 5\text{ V}$, $I_C = 90\text{ mA}$, pulse measured ²⁾

4.2 AC parameter tables

Table 6 General AC characteristics at $T_A = 25\text{ °C}$

Parameter	Symbol	Values			Unit	Note or test condition
		Min.	Typ.	Max.		
Transition frequency	f_T	–	20	–	GHz	$V_{CE} = 5\text{ V}$, $I_C = 90\text{ mA}$
Collector base capacitance	C_{CB}		0.37		pF	$V_{CB} = 5\text{ V}$, $V_{BE} = 0\text{ V}$, $f = 1\text{ MHz}$, emitter grounded
Collector emitter capacitance	C_{CE}		1.4			$V_{CE} = 5\text{ V}$, $V_{BE} = 0\text{ V}$, $f = 1\text{ MHz}$, base grounded
Emitter base capacitance	C_{EB}		3.3			$V_{EB} = 0.5\text{ V}$, $V_{CB} = 0\text{ V}$, $f = 1\text{ MHz}$, collector grounded

¹ Accuracy is not limited by the device but by the cycle time of the 100% test.

² Test duration 14 ms, duty cycle 46%. Regard that the current gain h_{FE} depends on the junction temperature T_J and T_J amongst others from the thermal resistance R_{thSA} of the PCB, see notes on [Table 3](#). Hence the h_{FE} specified in this data sheet must not be the same as in the application. It is recommended to apply circuit design techniques to make the collector current I_C independent on the h_{FE} production variation and temperature effects.

Electrical performance in test fixture

Measurement setup for the AC characteristics shown in [Table 7](#) to [Table 10](#) is a test fixture with Bias-T's and tuners to adjust the source and load impedance in a 50 Ω system. $T_A = 25\text{ °C}$.

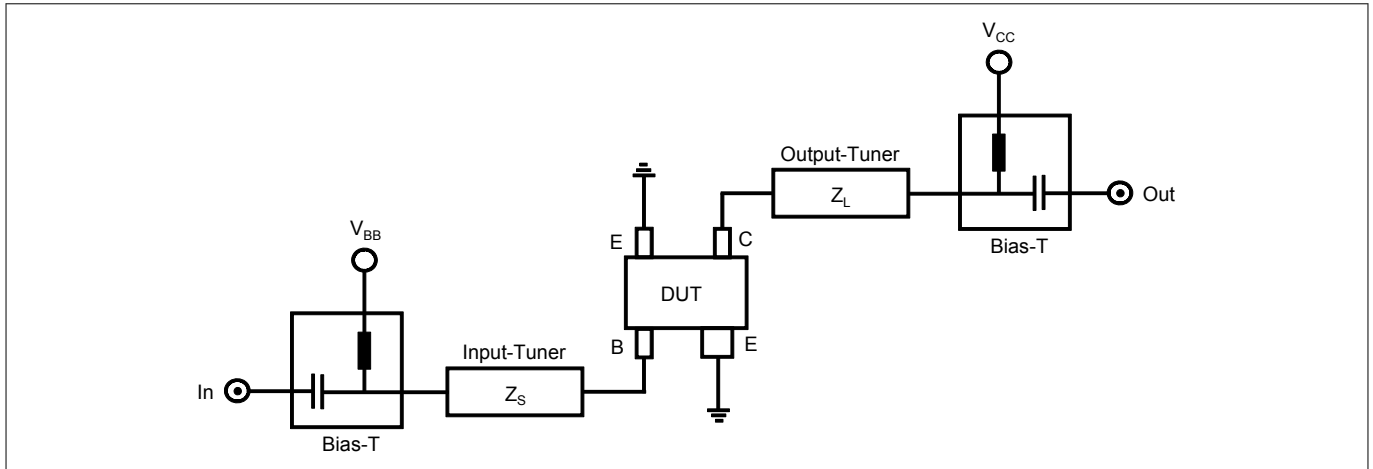

Figure 2 BFP780 testing circuit

Table 7 AC characteristics, $V_{CE} = 5\text{ V}$, $f = 900\text{ MHz}$

Parameter	Symbol	Values			Unit	Note or test condition
		Min.	Typ.	Max.		
Power gain		–		–	dB	$I_C = 90\text{ mA}$
Maximum power gain	G_{ms}		27			
Transducer gain	$ S_{21} ^2$		21.5			
Minimum noise figure					dBm	$I_C = 30\text{ mA}$
Minimum noise figure	NF_{min}		1.2			
Linearity					dBm	$Z_L = Z_{L,opt}(P_{out}),$ $I_C = 90\text{ mA}$
1 dB compression point at output	OP_{1dB}		23			
3rd order intercept point at output	OIP_3		34.5			

Table 8 AC characteristics, $V_{CE} = 5\text{ V}$, $f = 1.8\text{ GHz}$

Parameter	Symbol	Values			Unit	Note or test condition
		Min.	Typ.	Max.		
Power gain		–		–	dB	$I_C = 90\text{ mA}$
Maximum power gain	G_{ms}		22			
Transducer gain	$ S_{21} ^2$		15			
Minimum noise figure					dBm	$I_C = 30\text{ mA}$
Minimum noise figure	NF_{min}		1.4			
Linearity					dBm	$Z_L = Z_{L,opt}(P_{out}),$ $I_C = 90\text{ mA}$
1 dB compression point at output	OP_{1dB}		22			
3rd order intercept point at output	OIP_3		34			

Electrical performance in test fixture

Table 9 AC characteristics, $V_{CE} = 5\text{ V}$, $f = 2.6\text{ GHz}$

Parameter	Symbol	Values			Unit	Note or test condition
		Min.	Typ.	Max.		
Power gain		-		-	dB	$I_C = 90\text{ mA}$
Maximum power gain	G_{ma}		18			
Transducer gain	$ S_{21} ^2$		12			
Minimum noise figure						
Minimum noise figure	NF_{min}		1.7			$I_C = 30\text{ mA}$
Linearity					dBm	$Z_L = Z_{L,opt}(P_{out})$, $I_C = 90\text{ mA}$
1 dB compression point at output	OP_{1dB}		22			
3rd order intercept point at output	OIP_3		34			

Table 10 AC characteristics, $V_{CE} = 5\text{ V}$, $f = 3.5\text{ GHz}$

Parameter	Symbol	Values			Unit	Note or test condition
		Min.	Typ.	Max.		
Power gain		-		-	dB	$I_C = 90\text{ mA}$
Maximum power gain	G_{ma}		15			
Transducer gain	$ S_{21} ^2$		8.5			
Minimum noise figure						
Minimum noise figure	NF_{min}		2.4			$I_C = 30\text{ mA}$
Linearity					dBm	$Z_L = Z_{L,opt}(P_{out})$, $I_C = 90\text{ mA}$
1 dB compression point at output	OP_{1dB}		22			
3rd order intercept point at output	OIP_3		33.5			

Electrical performance in test fixture

4.3 Characteristic DC diagrams

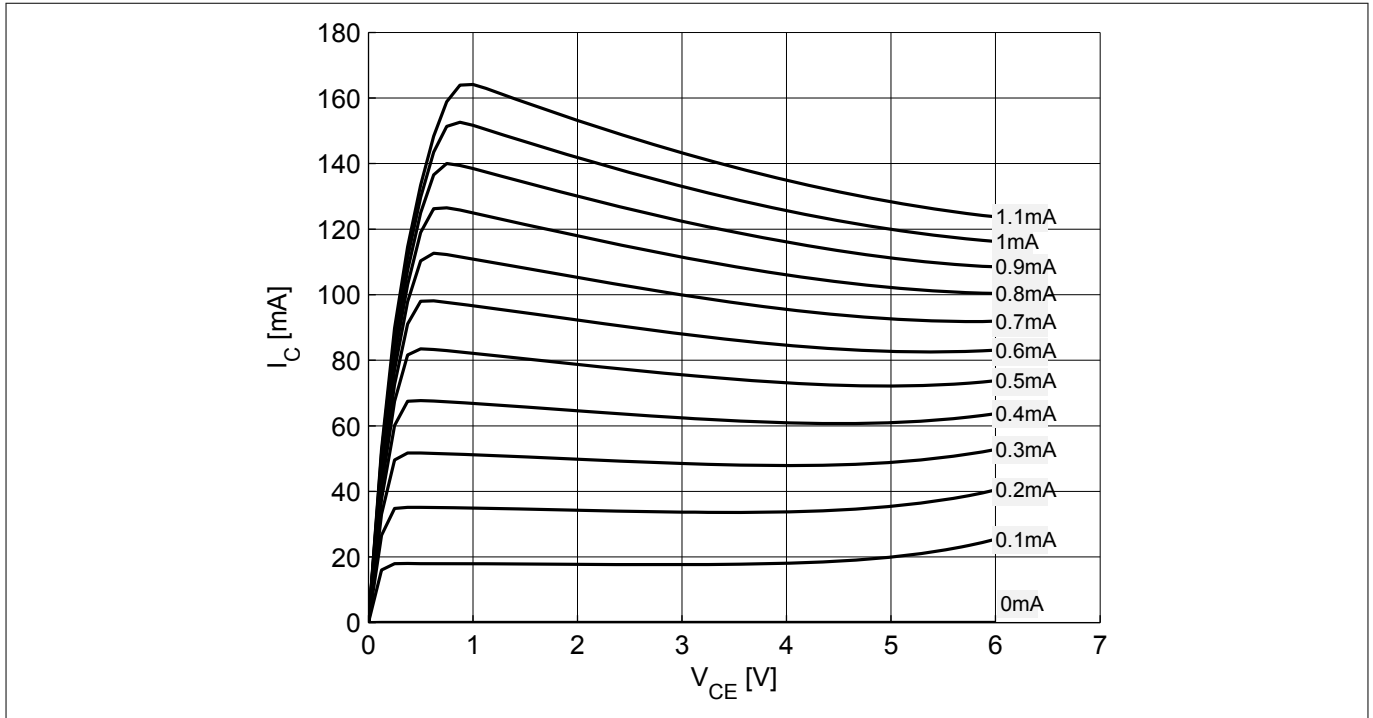

Figure 3 Collector current vs. collector emitter voltage $I_C = f(V_{CE})$, $I_B = \text{parameter}$

Note: Refer to absolute maximum ratings for I_C , V_{CE} and P_{diss} .

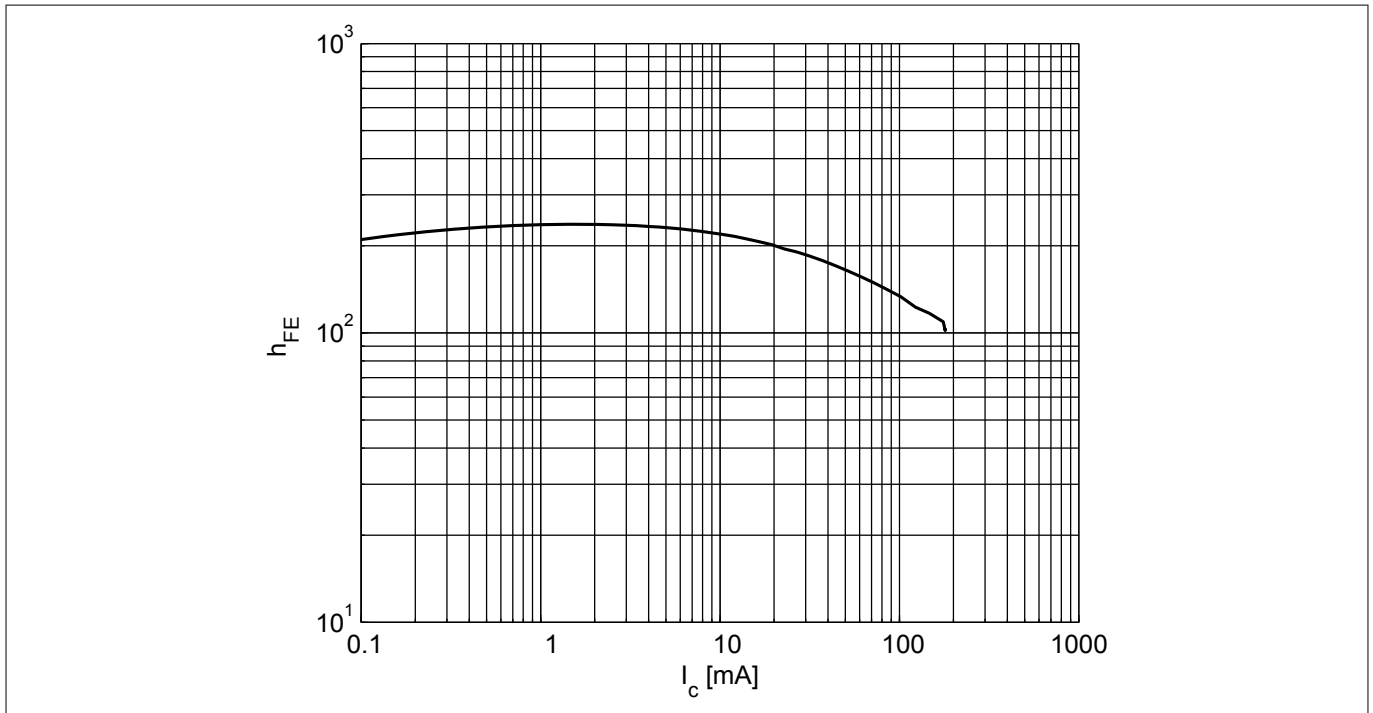

Figure 4 DC Current gain $h_{FE} = f(I_C)$, $V_{CE} = 5 \text{ V}$

Electrical performance in test fixture

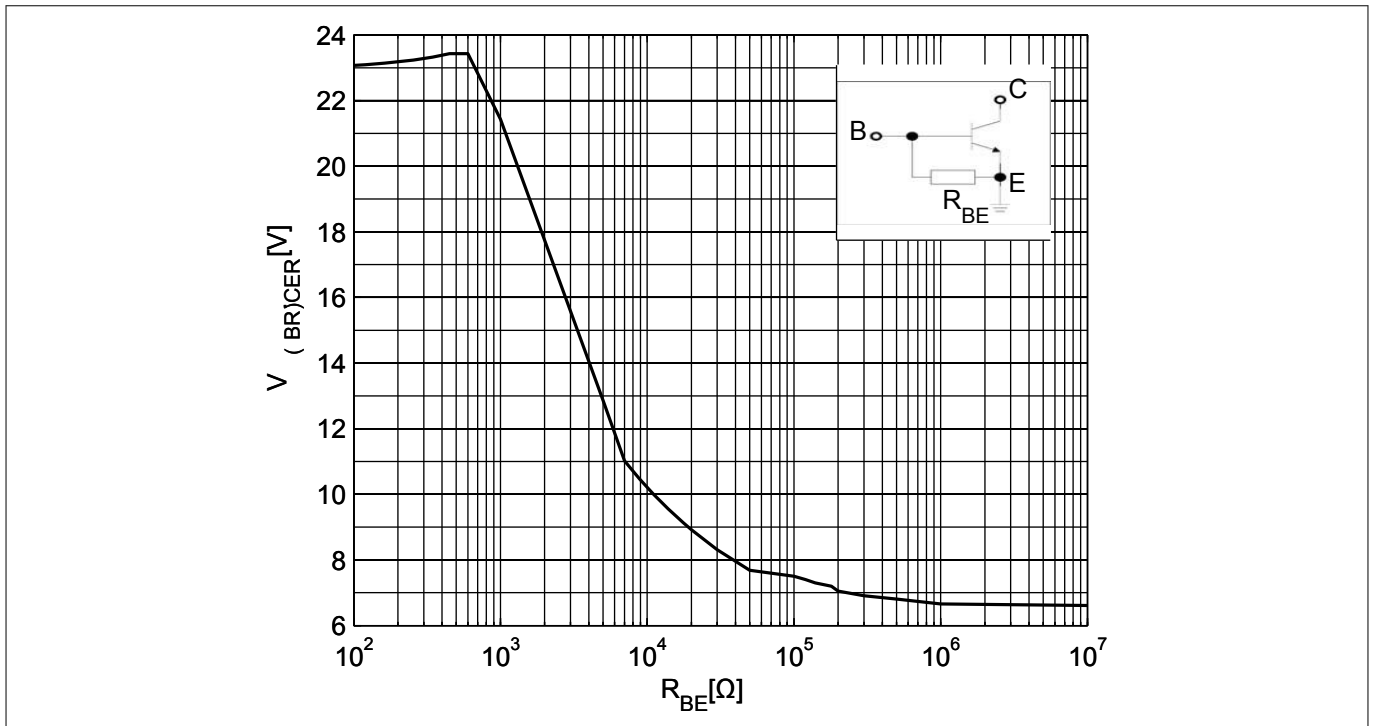

Figure 5 Collector emitter breakdown voltage $V_{(BR)CER} = f(R_{BE})$

Note: The above figure shows the collector-emitter breakdown voltage $V_{(BR)CER}$ with a resistor R_{BE} between base and emitter. Only for very high R_{BE} values ("open base") the breakdown voltage $V_{(BR)CER}$ is as low as $V_{(BR)CEO}$ (here 6.6 V). With decreasing R_{BE} values $V_{(BR)CER}$ increases, e.g. at $R_{BE} = 10 \text{ k}\Omega$ to $V_{(BR)CEO} = 10 \text{ V}$. In the application the biasing base resistance together with block capacitors take over the function of R_{BE} and allows the RF voltage amplitude to swing up to voltages much higher than $V_{(BR)CEO}$, without clipping. Due to this effect the transistor can be biased at $V_{CE} = 5 \text{ V}$ and still high RF output powers achieved, see the OP_{1dB} values reported in [Chapter 4.2](#).

Electrical performance in test fixture

4.4 Characteristic AC diagrams

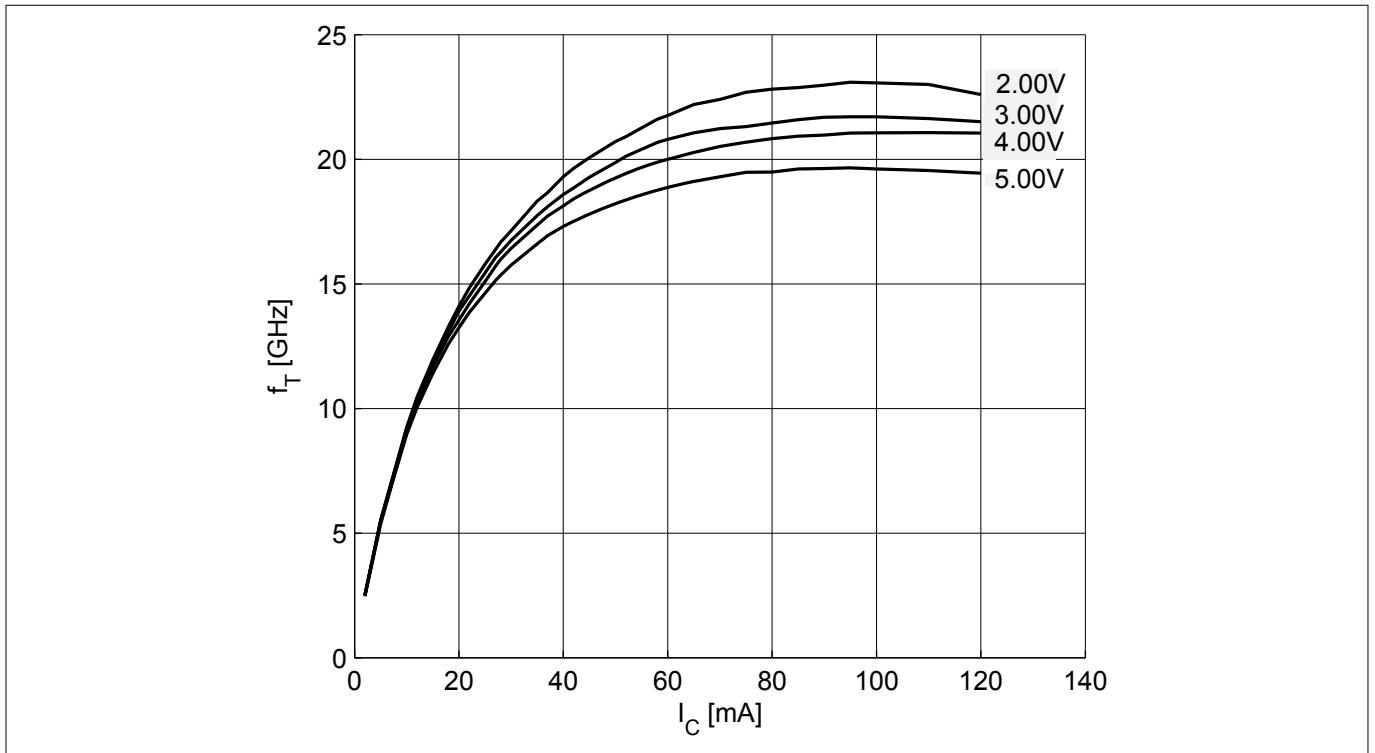

Figure 6 Transition frequency $f_T = f(I_C)$, $V_{CE} = \text{parameter}$

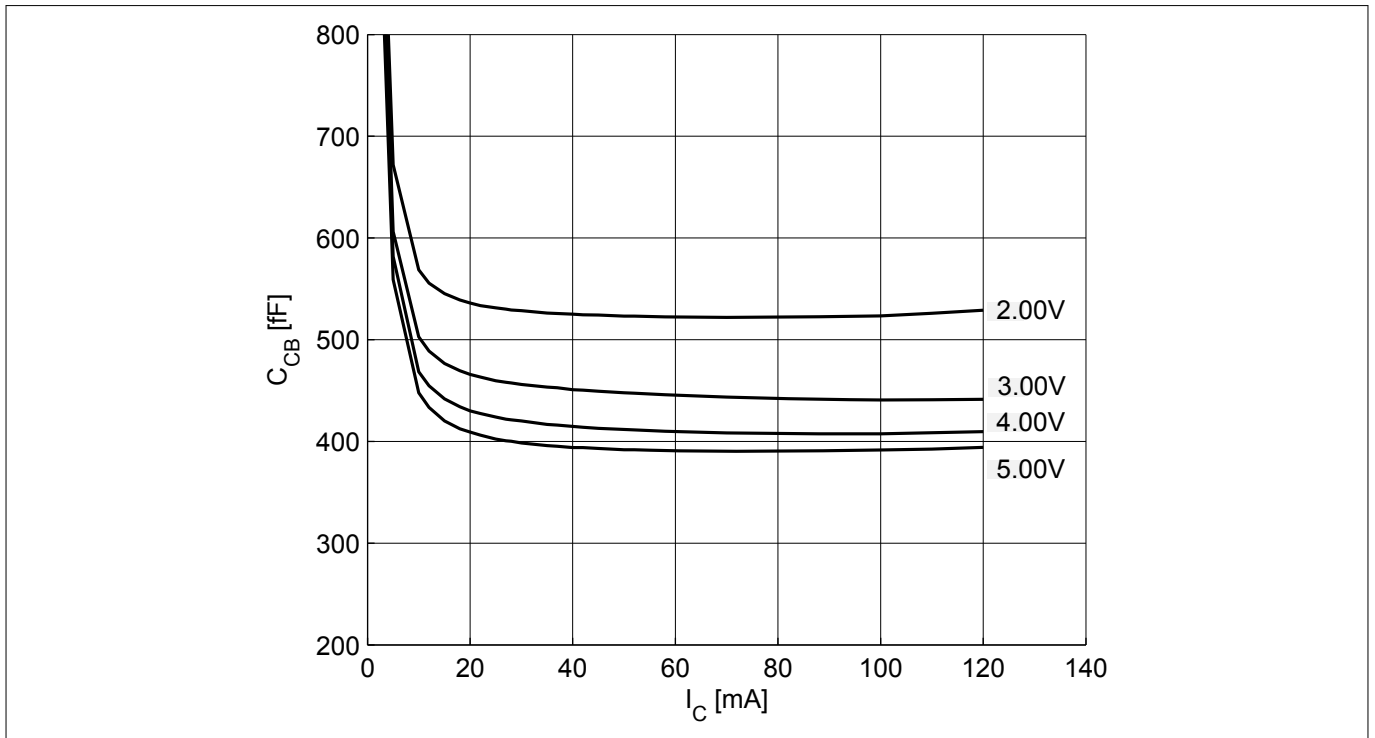

Figure 7 Collector base capacitance $C_{CB} = f(I_C)$, $f = 1 \text{ GHz}$, $V_{CB} = \text{parameter}$

Electrical performance in test fixture

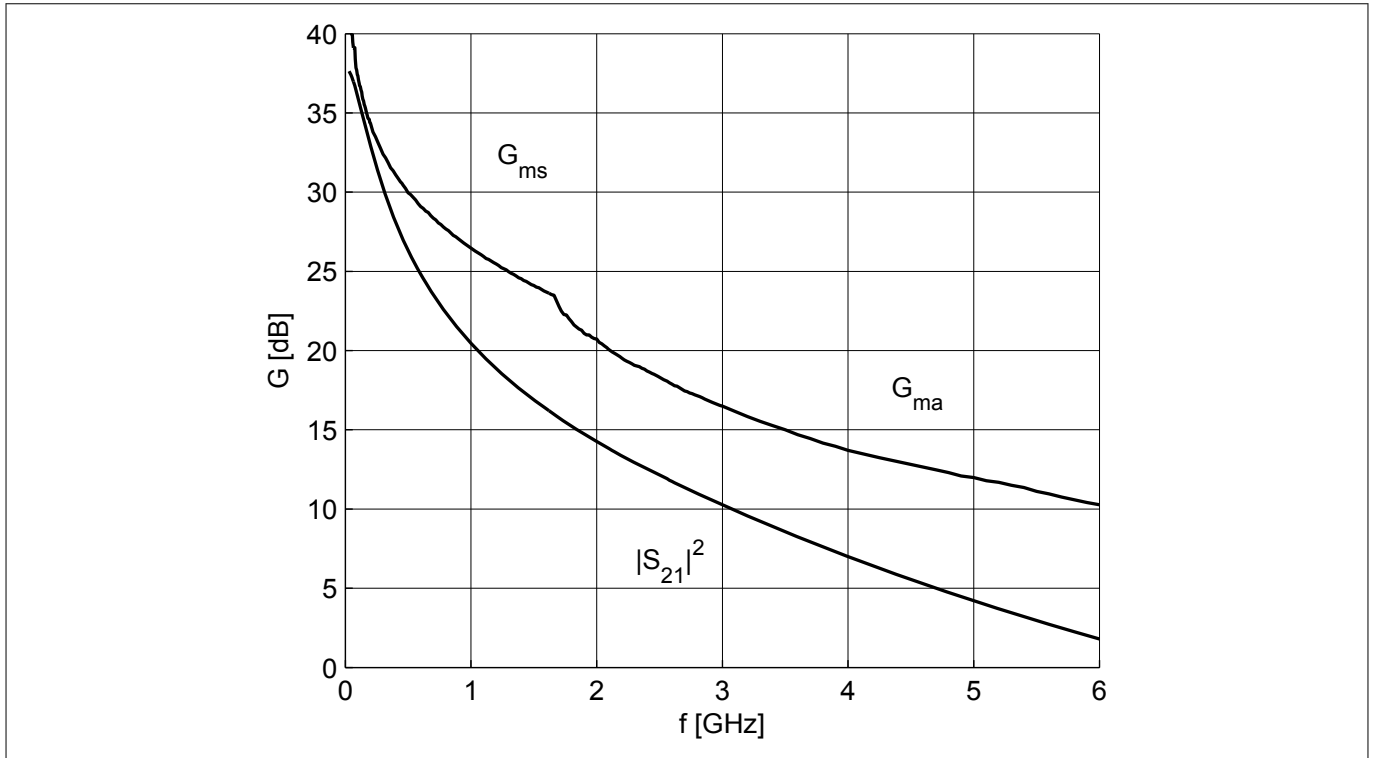

Figure 8 Gain G_{ms} , G_{ma} , $|S_{21}|^2 = f(f)$, $V_{CE} = 5\text{ V}$, $I_C = 90\text{ mA}$

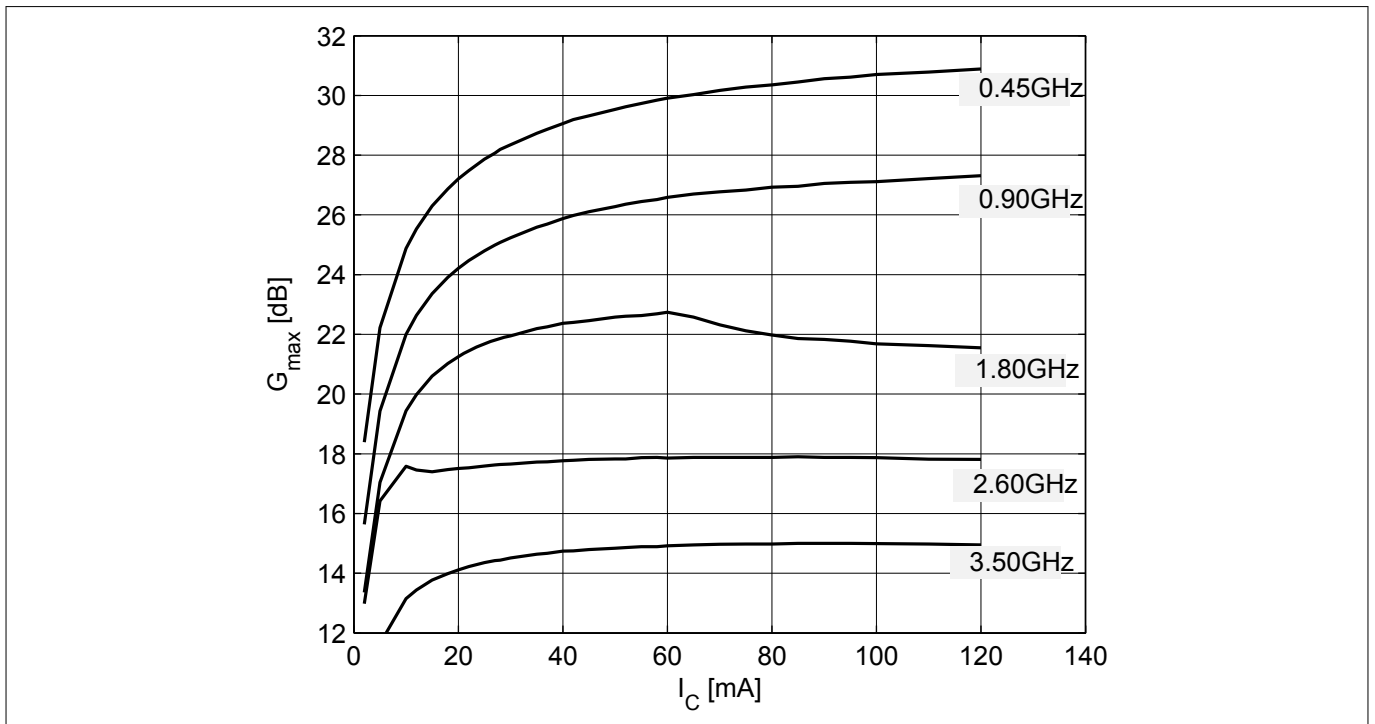

Figure 9 Maximum power gain $G_{max} = f(I_C)$, $V_{CE} = 5\text{ V}$, $f = \text{parameter}$

Electrical performance in test fixture

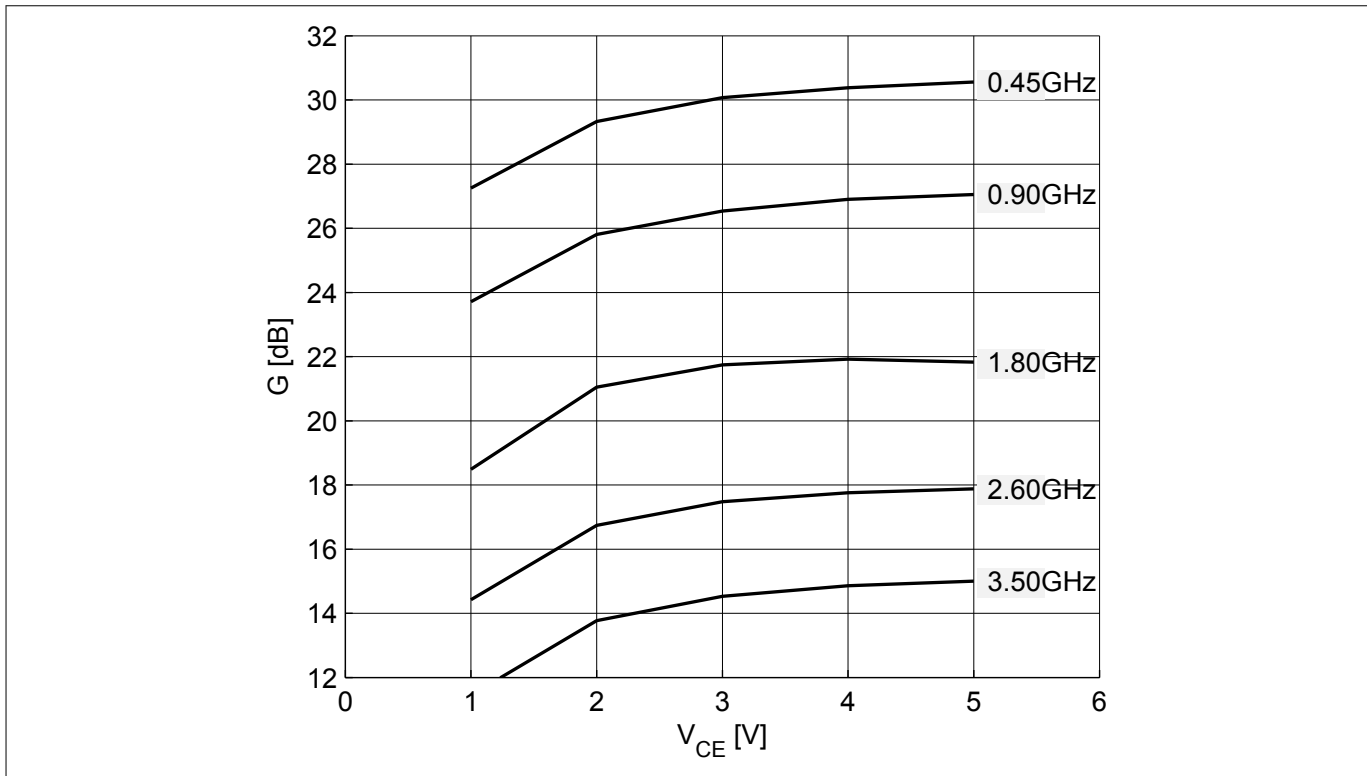

Figure 10 Maximum power gain $G_{max} = f(V_{CE}), I_C = 90 \text{ mA}, f = \text{parameter}$

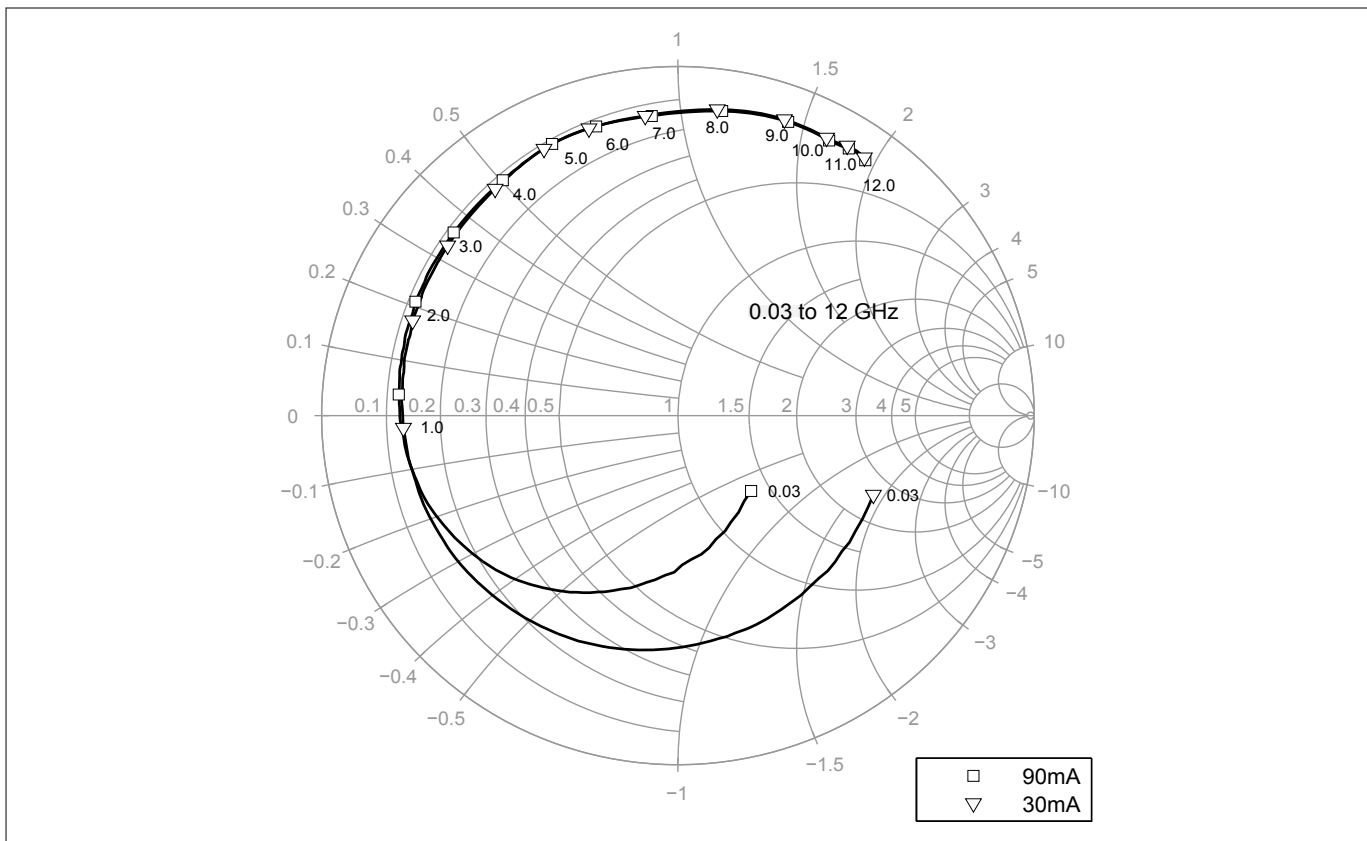

Figure 11 Input reflection coefficient $S_{11} = f(f), V_{CE} = 5 \text{ V}, I_C = \text{parameter}$

Electrical performance in test fixture

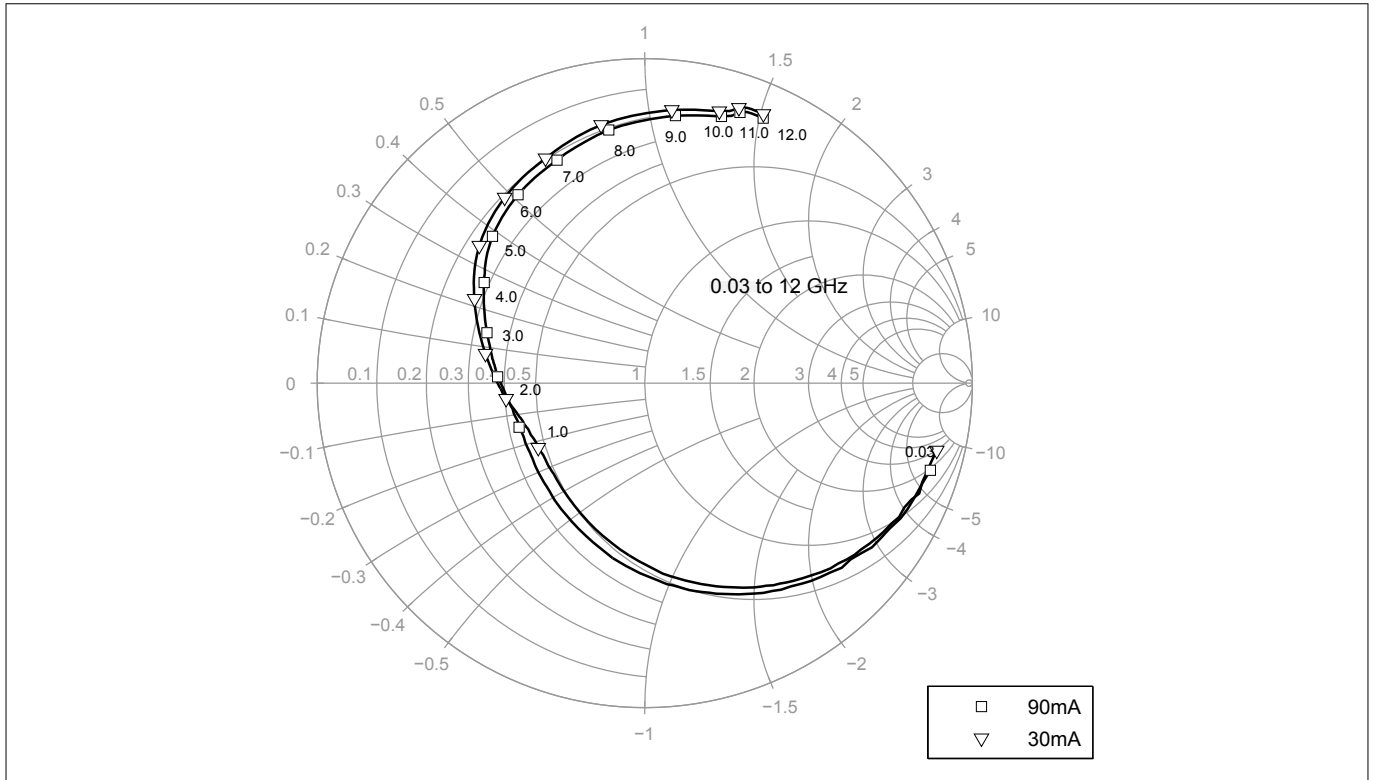

Figure 12 Output reflection coefficient $S_{22} = f(f)$, $V_{CE} = 5\text{ V}$, $I_C = \text{parameter}$

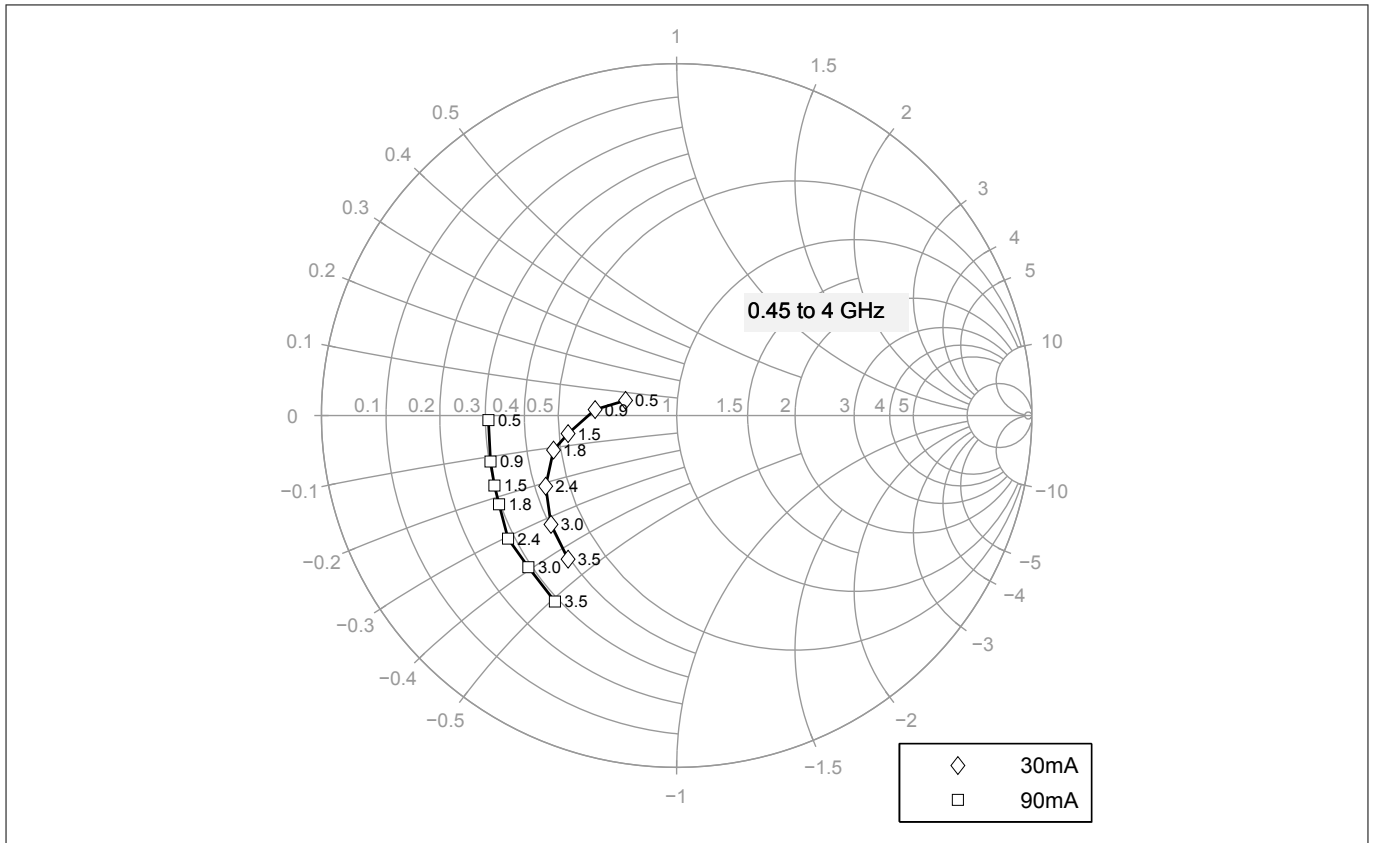

Figure 13 Source impedance for minimum noise figure $Z_{S,opt} = f(f)$, $V_{CE} = 5\text{ V}$, $I_C = \text{parameter}$

Electrical performance in test fixture

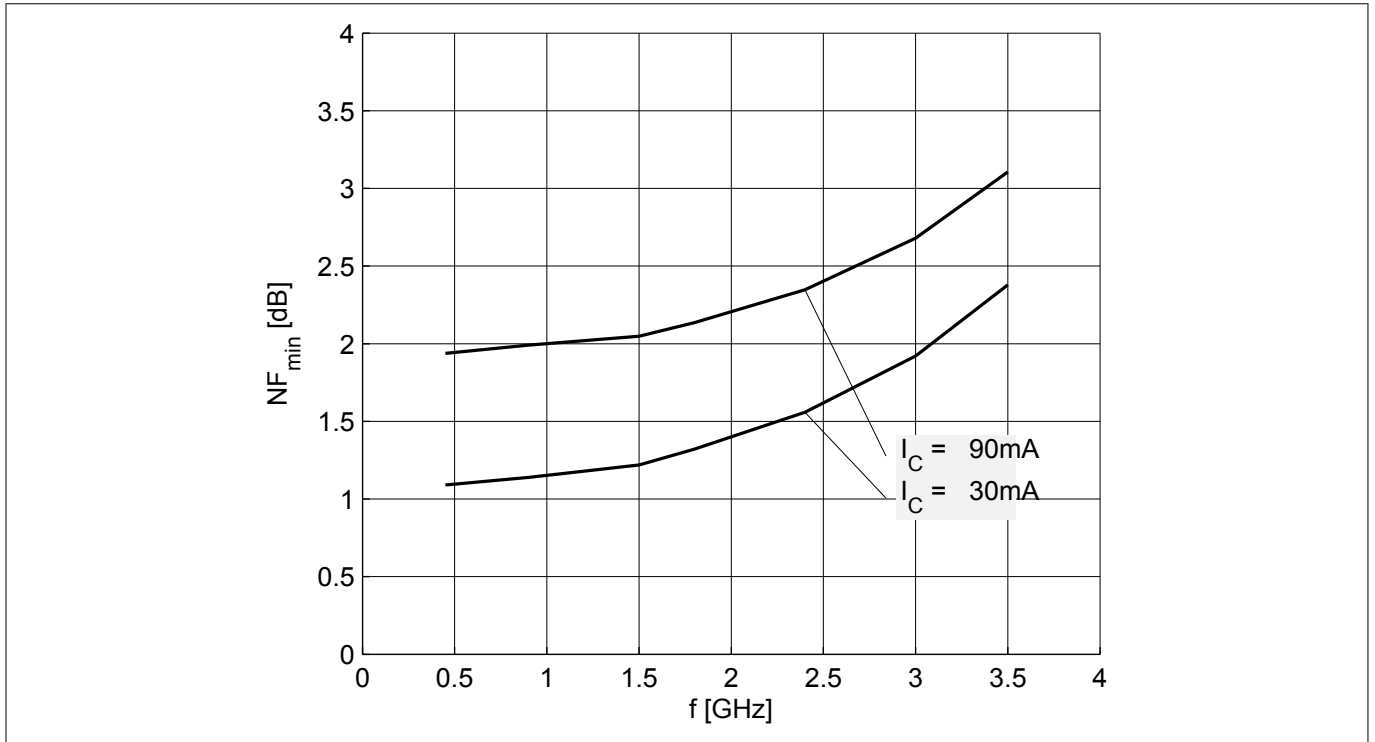

Figure 14 Noise figure $NF_{min} = f(f)$, $V_{CE} = 5\text{ V}$, $Z_S = Z_{S,opt}$, $I_C = \text{parameter}$

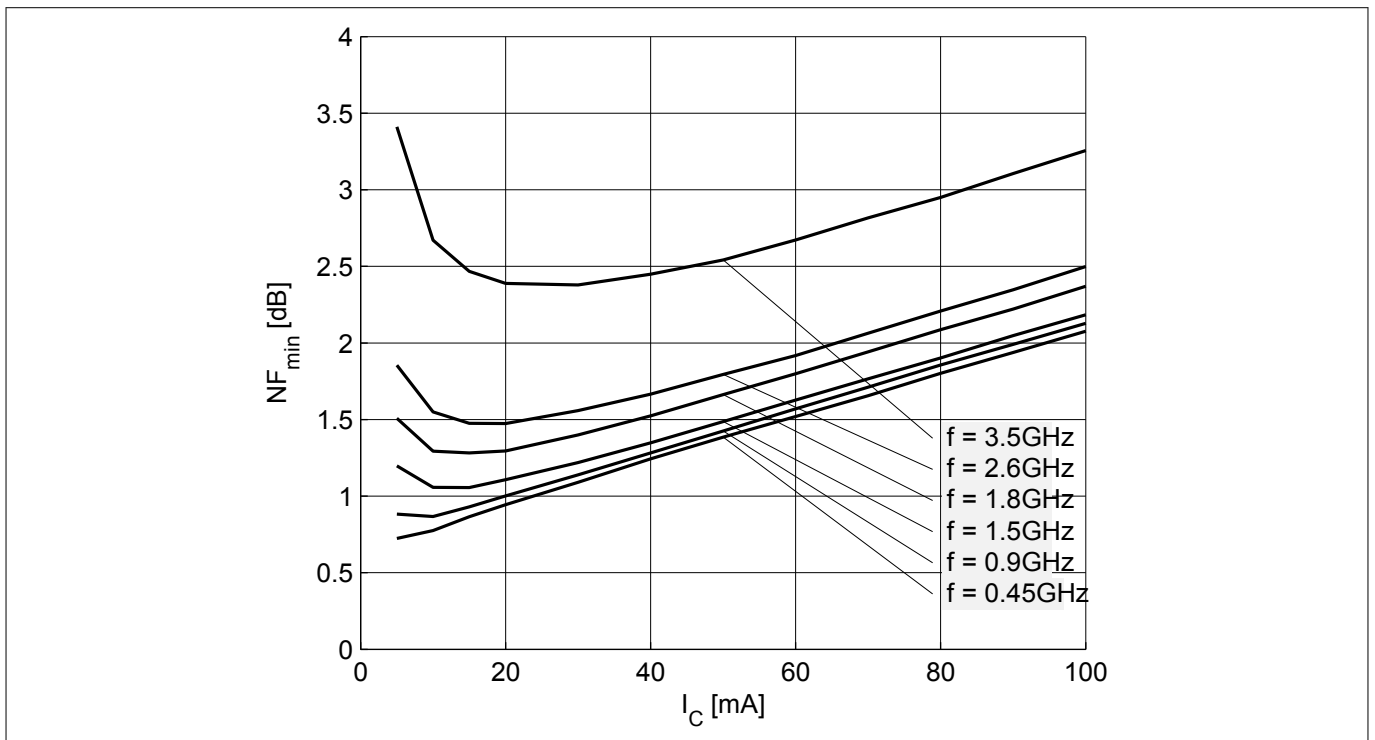

Figure 15 Noise figure $NF_{min} = f(I_C)$, $V_{CE} = 5\text{ V}$, $Z_S = Z_{S,opt}$, $f = \text{parameter}$

Electrical performance in test fixture

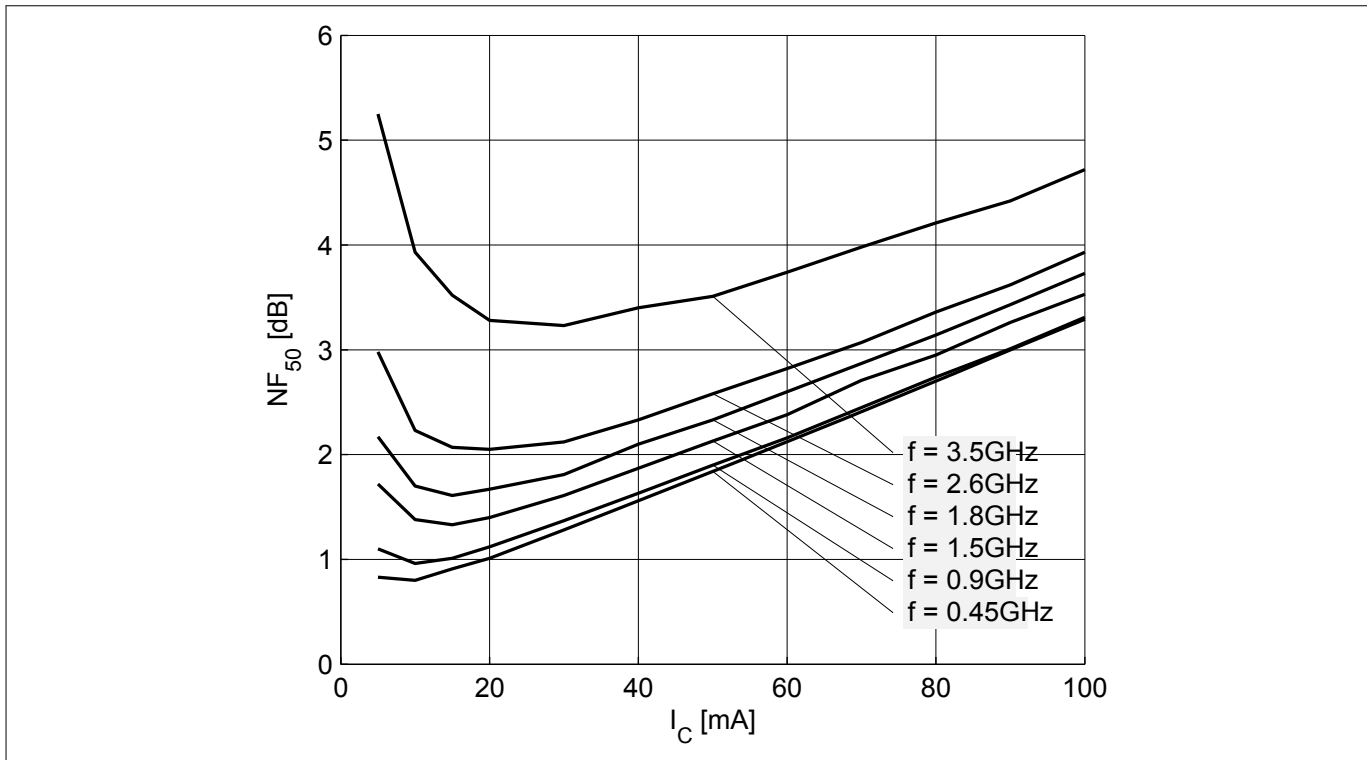

Figure 16 Noise figure $NF_{50} = f(I_C)$, $V_{CE} = 5$ V, $Z_S = 50 \Omega$, $f =$ parameter

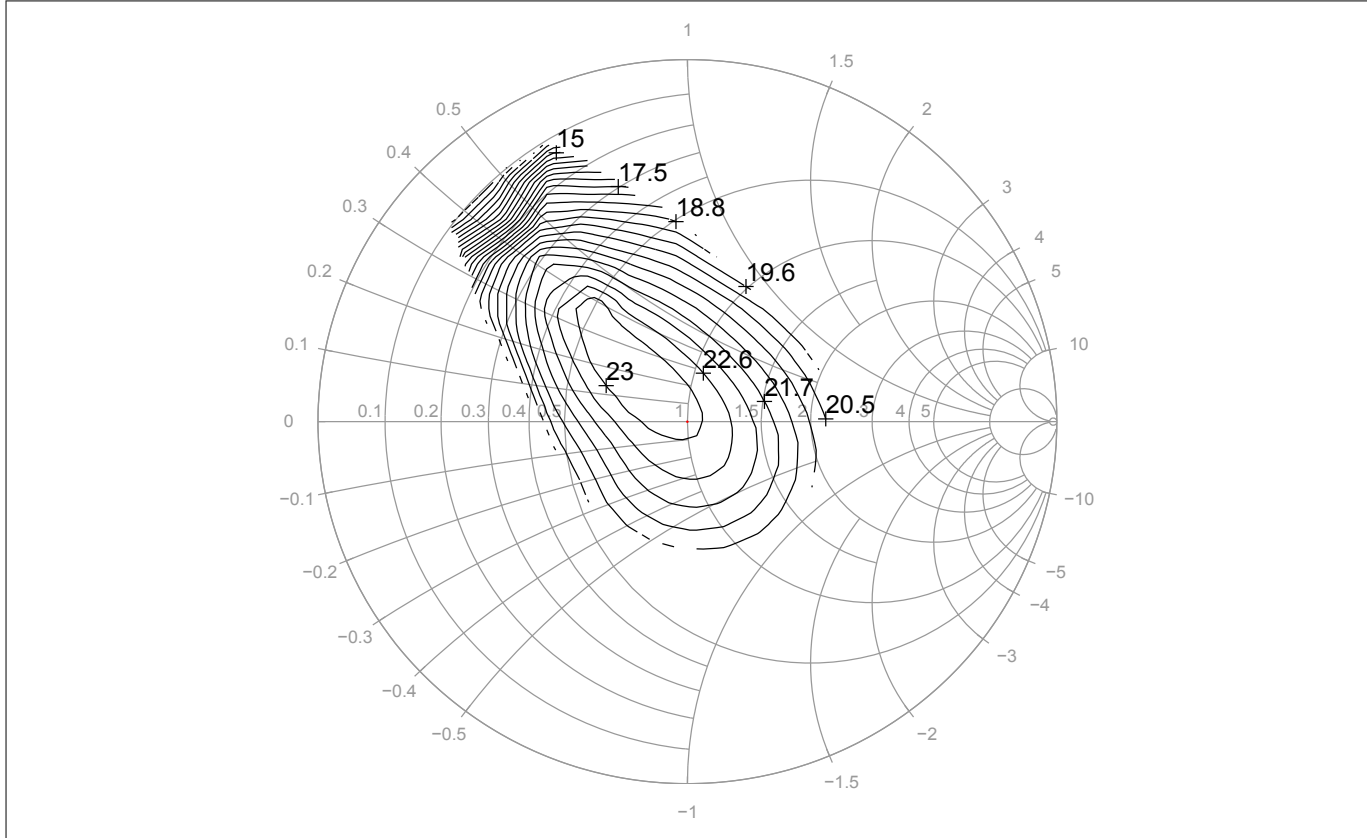

Figure 17 Load pull contour OP_{1dB} [dBm], $V_{CE} = 5$ V, $I_C = 90$ mA, $f = 900$ MHz

Electrical performance in test fixture

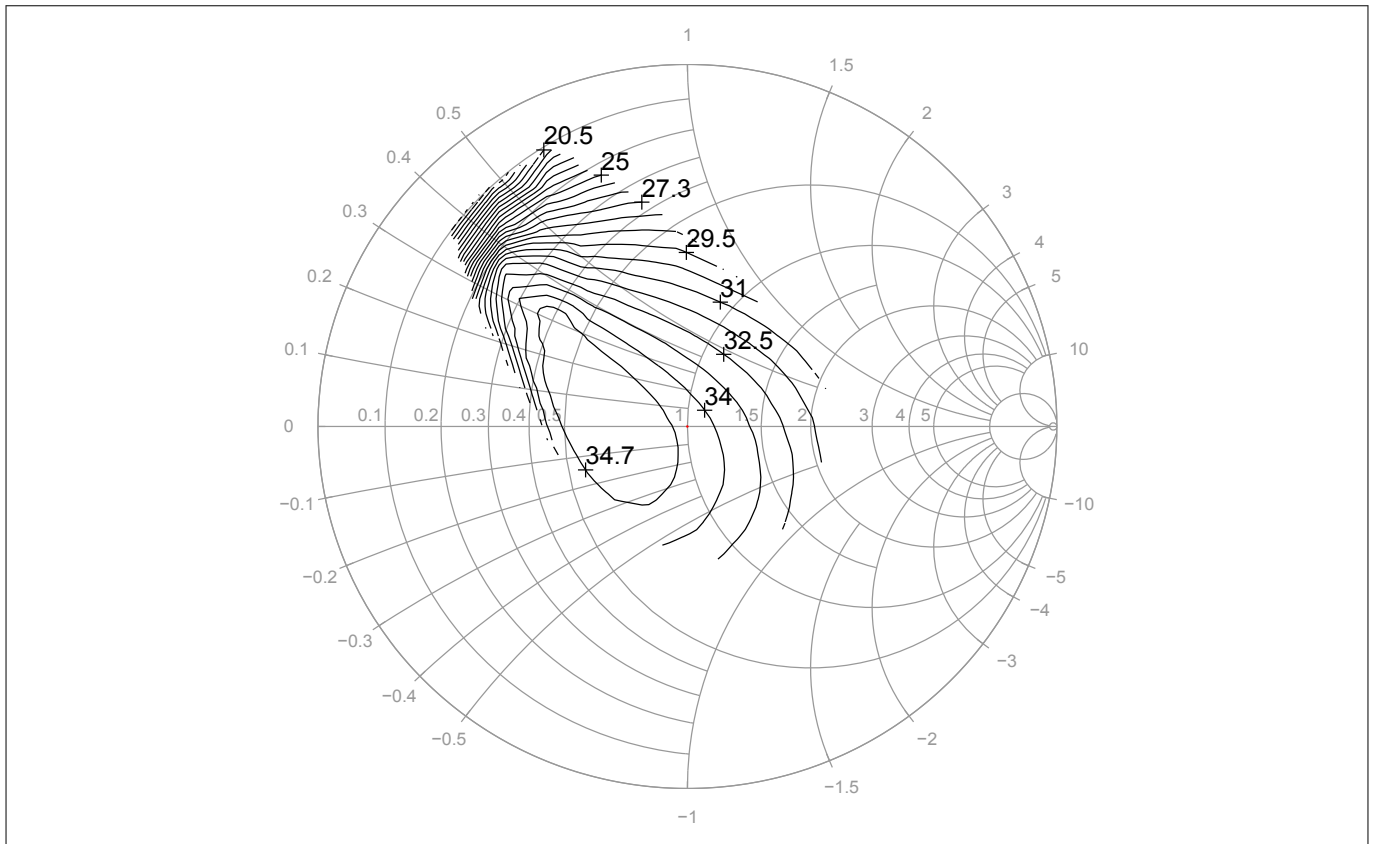

Figure 18 Load pull contour OIP_3 [dBm], $V_{CE} = 5\text{ V}$, $I_C = 90\text{ mA}$, $f = 900\text{ MHz}$

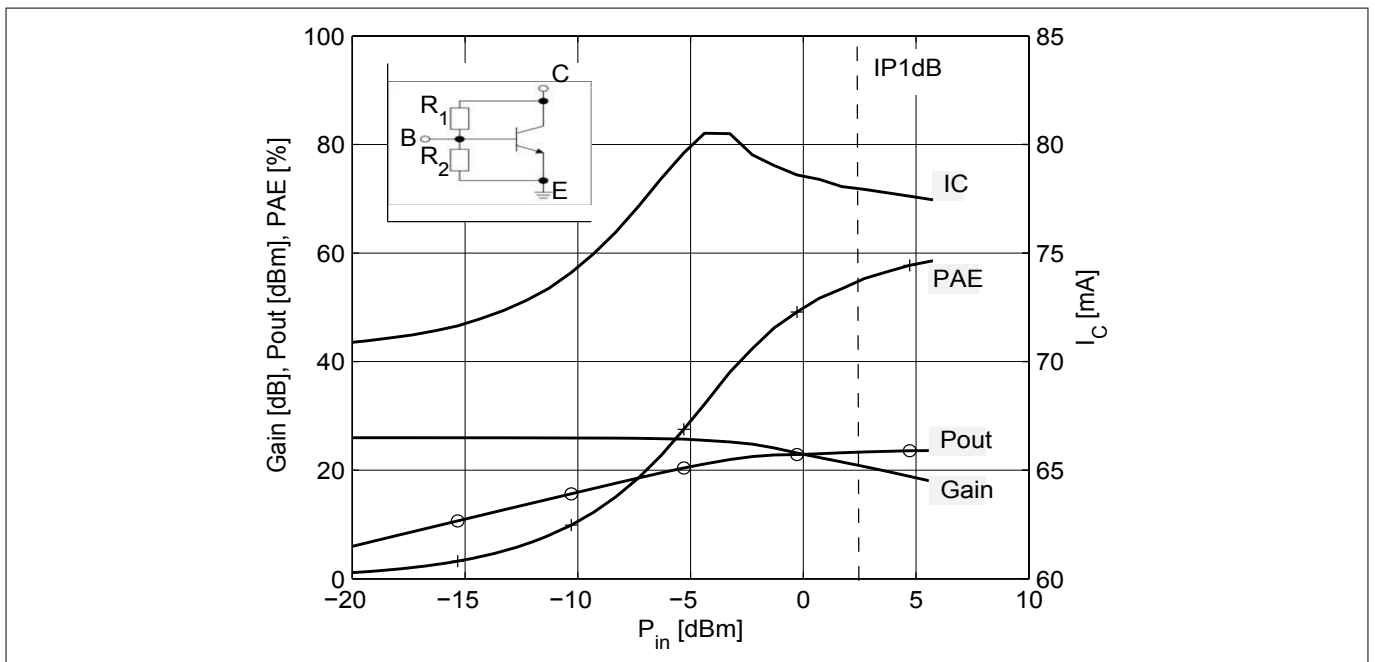

Figure 19 P_{out} , $Gain$, I_C , $PAE = f(P_{in})$, $V_{CE} = 5\text{ V}$, $f = 900\text{ MHz}$, $R_1 = 270\ \Omega$, $R_2 = 8\text{ k}\Omega$, $Z_L = Z_{L,opt}(P_{out})$

Note: The curves shown in this chapter have been generated using typical devices but shall not be understood as a guarantee that all devices have identical characteristic curves. $T_A = 25\text{ }^\circ\text{C}$.

5 Package information SOT343

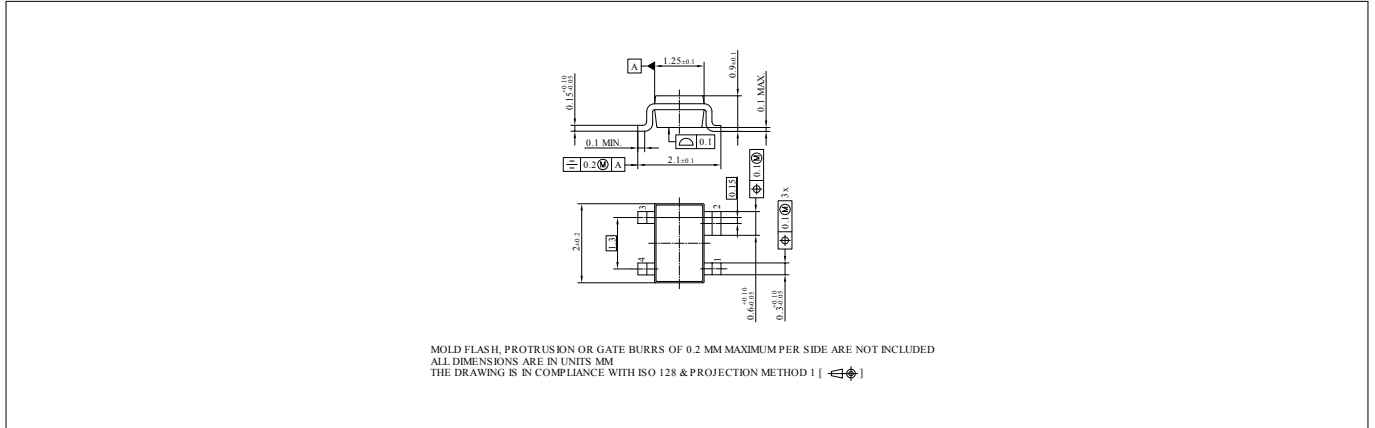

Figure 20 Package outline

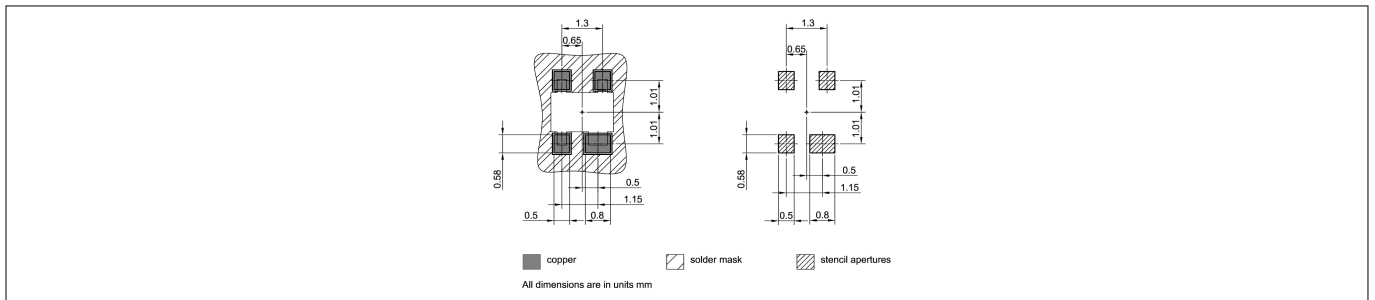

Figure 21 Foot print

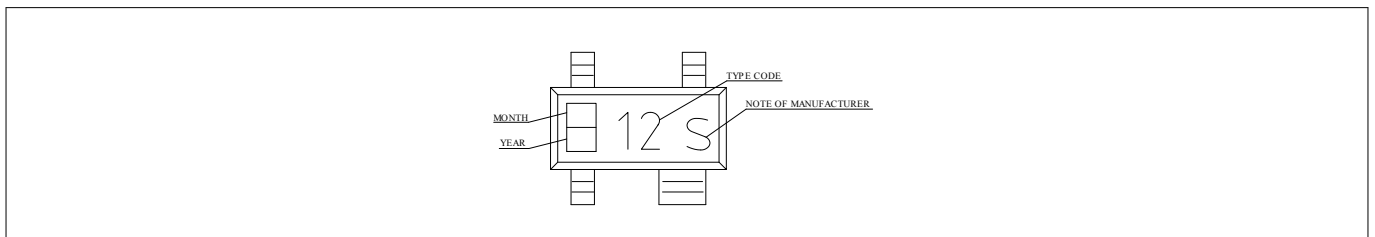

Figure 22 Marking layout example

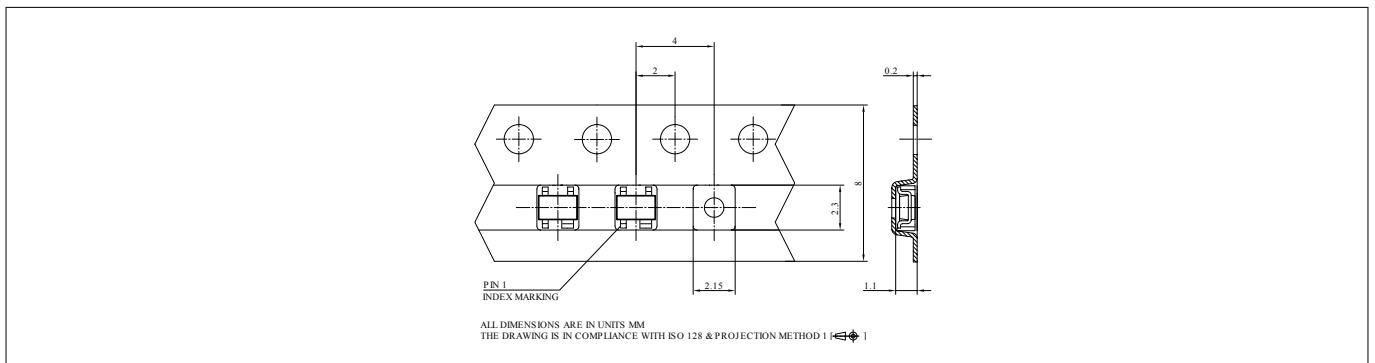

Figure 23 Tape dimensions

Revision history

Revision history

Document version	Date of release	Description of changes
4.0	2018-09-26	New datasheet layout.

Trademarks

All referenced product or service names and trademarks are the property of their respective owners.

Edition 2018-09-26

Published by
Infineon Technologies AG
81726 Munich, Germany

© 2018 Infineon Technologies AG
All Rights Reserved.

Do you have a question about any
aspect of this document?
Email: erratum@infineon.com

Document reference
IFX-ebx1468299694130

IMPORTANT NOTICE

The information given in this document shall in no event be regarded as a guarantee of conditions or characteristics ("Beschaffheitsgarantie").

With respect to any examples, hints or any typical values stated herein and/or any information regarding the application of the product, Infineon Technologies hereby disclaims any and all warranties and liabilities of any kind, including without limitation warranties of non-infringement of intellectual property rights of any third party.

In addition, any information given in this document is subject to customer's compliance with its obligations stated in this document and any applicable legal requirements, norms and standards concerning customer's products and any use of the product of Infineon Technologies in customer's applications.

The data contained in this document is exclusively intended for technically trained staff. It is the responsibility of customer's technical departments to evaluate the suitability of the product for the intended application and the completeness of the product information given in this document with respect to such application.

WARNINGS

Due to technical requirements products may contain dangerous substances. For information on the types in question please contact your nearest Infineon Technologies office.

Except as otherwise explicitly approved by Infineon Technologies in a written document signed by authorized representatives of Infineon Technologies, Infineon Technologies' products may not be used in any applications where a failure of the product or any consequences of the use thereof can reasonably be expected to result in personal injury

Mouser Electronics

Authorized Distributor

Click to View Pricing, Inventory, Delivery & Lifecycle Information:

[Infineon:](#)

[BFP780H6327XTSA1](#)