

Battrax® Series - Single Port Negative - MS-013

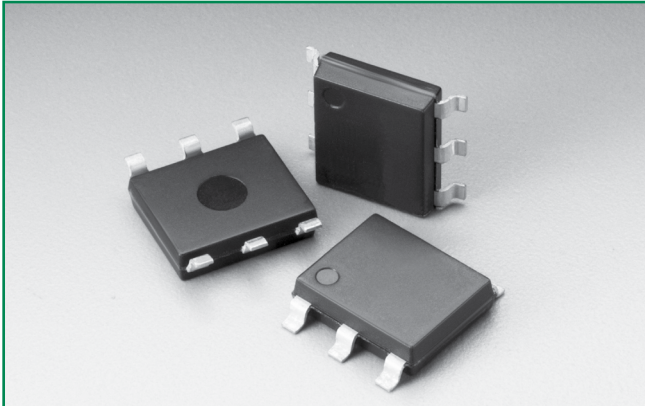

Agency Approvals

Agency	Agency File Number
	E133083

Pinout Designation

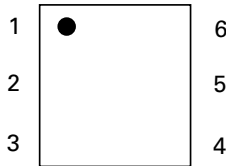

Schematic Symbol

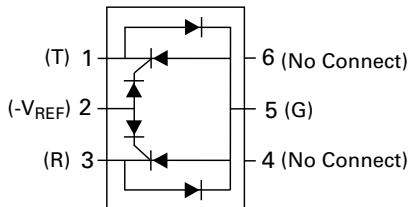

Description

The Battrax® Protection Thyristor series offers programmable SIDACtor® overvoltage protection components for SLIC applications. The Single Port Negative Battrax® Protection Thyristor series provides a programmable device that is referenced to a negative voltage source while internal diodes provide protection from positive surge events.

Features and Benefits

- Low voltage overshoot device
- Low on-state voltage
- Does not degrade surge capability after multiple surge events within limit.
- Fails short circuit when surged in excess of ratings
- Single-port protection
- Gate triggered tracking
- Integrated diodes for positive voltage protection
- Pb-free E3 means 2nd level interconnect is Pb-free and the terminal finish material is tin(Sn) (IPC/JEDEC J-STD-609A.01)
- RoHS compliant and lead-free

Applicable Global Standards

- TIA-968-A
- TIA-968-B
- ITU K.20/21 Enhanced Level
- ITU K.20/21 Basic Level
- GR 1089 Intra-building
- IEC 61000-4-5 2nd edition
- YD/T 1082
- YD/T 993
- YD/T 950

Additional Information



Datasheet



Resources



Samples

Electrical Characteristics

Part Number	Marking	V_{DRM}	V_S	I_H	I_S	I_T	V_T	V_F	Capacitance*	
		@ $I_{DRM} = 5\mu A$	@ 100V/ μs	mA min	mA max	A max	@ $I_T = 2.2$ Amps	V max	pF min	pF max
B1101UALxx	B1101UA	$-V_{REF} + I + 1.2VI$	$-V_{REF} + I + 10VI$	100	100	2.2	4	5	30	200
B1161UALxx	B1161UA	$-V_{REF} + I + 1.2VI$	$-V_{REF} + I + 10VI$	160	100	2.2	4	5	30	200
B1201UALxx	B1201UA	$-V_{REF} + I + 1.2VI$	$-V_{REF} + I + 10VI$	200	100	2.2	4	5	30	200
B1101UCLxx	B1101UC	$-V_{REF} + I + 1.2VI$	$-V_{REF} + I + 10VI$	100	100	2.2	4	5	30	200
B1161UCLxx	B1161UC	$-V_{REF} + I + 1.2VI$	$-V_{REF} + I + 10VI$	160	100	2.2	4	5	30	200
B1201UCLxx	B1201UC	$-V_{REF} + I + 1.2VI$	$-V_{REF} + I + 10VI$	200	100	2.2	4	5	30	200

Notes:
 - Absolute maximum ratings measured at $T_c = 25^\circ C$ (unless otherwise noted).
 - Components are not appropriate for positive ringing systems.
 - All electrical characteristics shown are defined from Tip (pin 1) to Ground (pin 5), and Ring (pin 3) to Ground (pin 5)

- V_{REF} Max Value for the negative Battrax is -200 V.
 - **XX** = Part Number Suffix: **TP** (Tube Pack) or **RP** (Reel Pack).
 * Off-state capacitance (C_o) is measured across pins 1 & 5 and 3 & 5 at 1 MHz with a 2V bias.

Surge Ratings

Series	I_{PP}									I_{TSM} 50/60 Hz	di/dt
	0.2/310 ¹ 0.5/700 ²	2/10 ¹ 2/10 ²	8/20 ¹ 1.2/50 ²	10/160 ¹ 10/160 ²	10/560 ¹ 10/560 ²	5/320 ¹ 9/720 ²	10/360 ¹ 10/360 ²	10/1000 ¹ 10/1000 ²	5/310 ¹ 10/700 ²		
	A min	A min	A min	A min	A min	A min	A min	A min	A min		
A	20	150	150	90	50	75	75	45	75	20	500
C	50	500	400	200	150	200	175	100	200	50	500

Notes:

- 1 Current waveform in μs
- 2 Voltage waveform in μs
- Peak pulse current rating (I_{PP}) is repetitive and guaranteed for the life of the product that remains in thermal equilibrium.
- I_{PP} ratings applicable over temperature range of $-40^{\circ}C$ to $+85^{\circ}C$ (I_{PP} rating assumes V_{REF} equals -48 V)
- The component must initially be in thermal equilibrium with $-40^{\circ}C \leq T_J \leq +150^{\circ}C$

Thermal Considerations

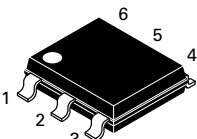
Package	Symbol	Parameter	Value	Unit
 Modified MS-013	T_J	Operating Junction Temperature Range	-40 to +125	$^{\circ}C$
	T_S	Storage Temperature Range	-65 to +150	$^{\circ}C$
	$R_{\theta JA}$	Thermal Resistance: Junction to Ambient	60	$^{\circ}C/W$

V-I Characteristics

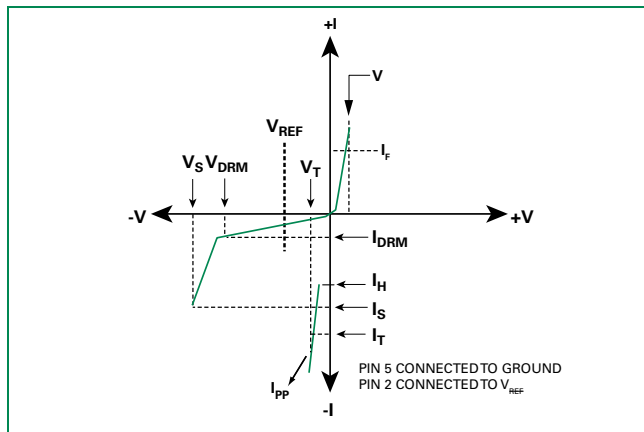

$t_r \times t_d$ Pulse Waveform

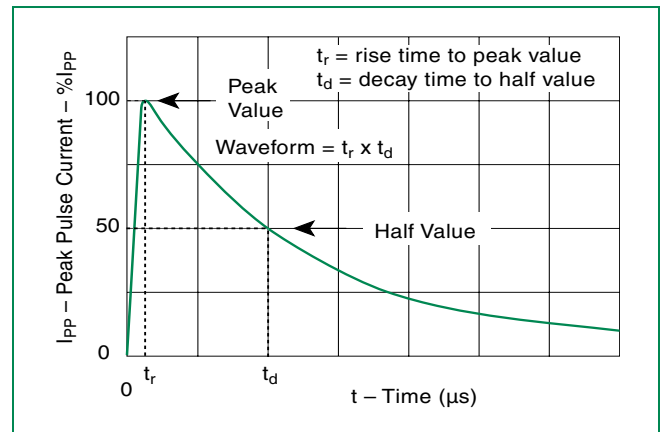

Normalized V_S Change vs. Junction Temperature

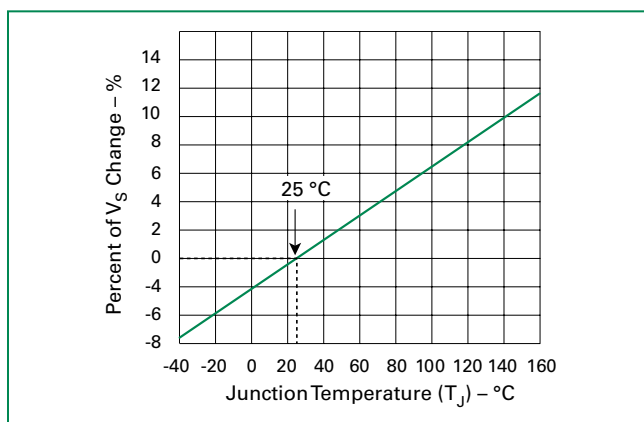

Normalized DC Holding Current vs. Case Temperature

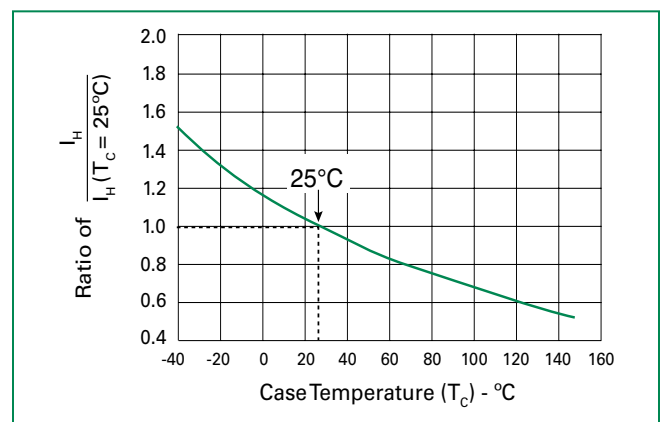

Soldering Parameters

Reflow Condition	Pb-Free assembly (see Fig. 1)	
Pre Heat	-Temperature Min ($T_{s(min)}$)	+150°C
	-Temperature Max ($T_{s(max)}$)	+200°C
	-Time (Min to Max) (t_s)	60-180 secs.
Average ramp up rate (Liquidus Temp (T_L) to peak)	3°C/sec. Max.	
$T_{s(max)}$ to T_L - Ramp-up Rate	3°C/sec. Max.	
Reflow	-Temperature (T_L) (Liquidus)	+217°C
	-Temperature (t_L)	60-150 secs.
Peak Temp (T_p)	+260(+0/-5)°C	
Time within 5°C of actual PeakTemp (t_p)	30 secs. Max.	
Ramp-down Rate	6°C/sec. Max.	
Time 25°C to Peak Temp (T_p)	8 min. Max.	
Do not exceed	+260°C	

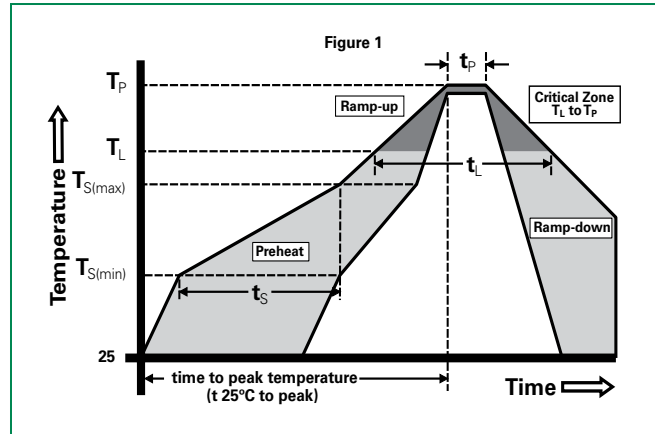

Physical Specifications

Lead Material	Copper Alloy
Terminal Finish	100% Matte-Tin Plated
Body Material	UL Recognized epoxy meeting flammability classification V-0

Environmental Specifications

High Temp Voltage Blocking	80% Rated V_{REF} Max. (V_{DC} Peak) +125°C or +150°C, 504 or 1008 hrs. MIL-STD-750 (Method 1040) JEDEC, JESD22-A-101
Temp Cycling	-65°C to +150°C, 15 min. dwell, 10 up to 100 cycles. MIL-STD-750 (Method 1051) EIA/JEDEC, JESD22-A104
Biased Temp & Humidity	52 V_{DC} (+85°C) 85%RH, 504 up to 1008 hrs. EIA/JEDEC, JESD22-A-101
High Temp Storage	+150°C 1008 hrs. MIL-STD-750 (Method 1031) JEDEC, JESD22-A-101
Low Temp Storage	-65°C, 1008 hrs.
Thermal Shock	0°C to +100°C, 5 min. dwell, 10 sec. transfer, 10 cycles. MIL-STD-750 (Method 1056) JEDEC, JESD22-A-106
Autoclave (Pressure Cooker Test)	+121°C, 100%RH, 2atm, 24 up to 168 hrs. EIA/JEDEC, JESD22-A-102
Resistance to Solder Heat	+260°C, 30 secs. MIL-STD-750 (Method 2031)
Moisture Sensitivity Level	85%RH, +85°C, 168 hrs., 3 reflow cycles (+260°C Peak). JEDEC-J-STD-020, Level 1

Part Numbering

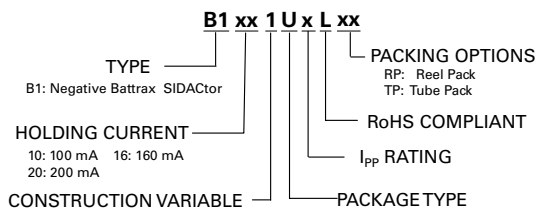

Part Marking

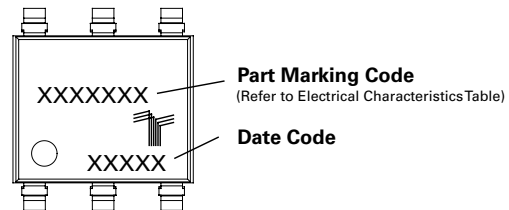

Dimensions — MS-013

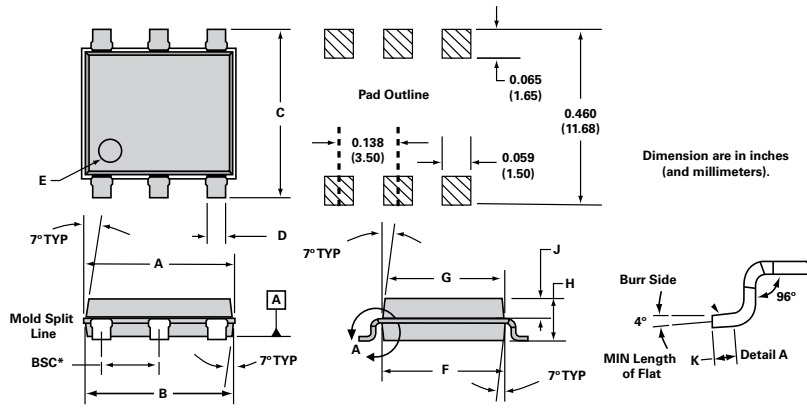

Dimensions	Inches		Millimeters	
	Min	Max	Min	Max
A	0.360	0.364	9.14	9.25
B	0.352	0.356	8.94	9.04
C	0.400	0.412	10.16	10.46
D	0.043	0.045	1.09	1.13
E	0.047	0.055	1.19	1.40
F	0.293	0.297	7.44	7.54
G	0.289	0.293	7.34	7.44
H	0.089	0.093	2.26	2.36
J	0.041	0.049	1.04	1.24
K	0.020		0.51	
BSC*	0.133	0.143	3.38	3.63

* BSC = Basic Spacing between Centers

Packing Options

Package Type	Description	Quantity	Added Suffix	Industry Standard
U	Modified MS-013 6-pin Tape and Reel Pack	1500	RP	EIA-481-D
	Modified MS-013 6-pin Tube Pack	500 (50 per tube)	TP	N/A

Tape and Reel Specification — MS-013

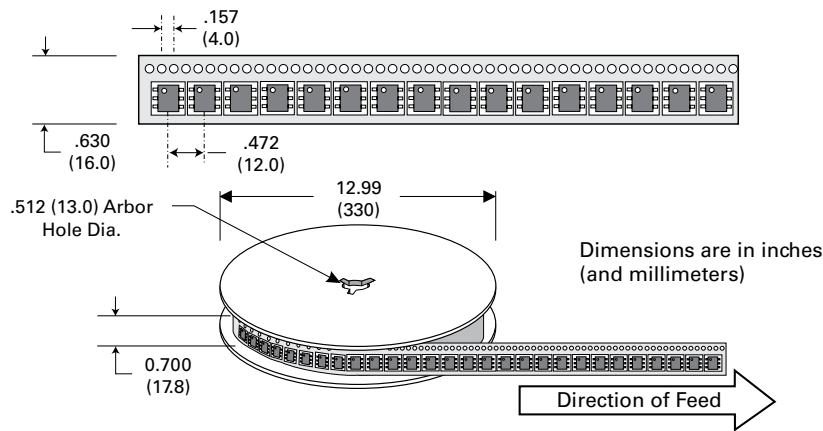

Tube Pack Specification — MS-013

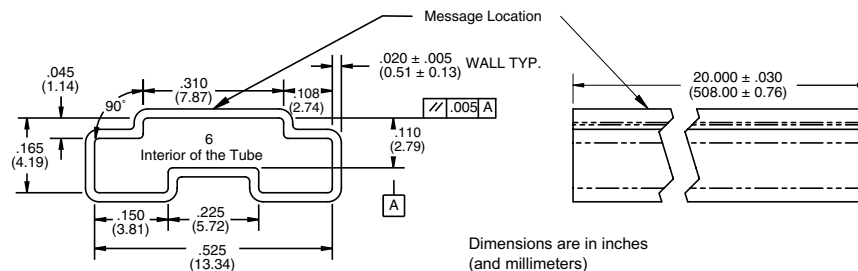

Disclaimer Notice - Information furnished is believed to be accurate and reliable. However, users should independently evaluate the suitability of and test each product selected for their own applications. Littelfuse products are not designed for, and may not be used in, all applications. Read complete Disclaimer Notice at www.littelfuse.com/disclaimer-electronics.

Mouser Electronics

Authorized Distributor

Click to View Pricing, Inventory, Delivery & Lifecycle Information:

Littelfuse:

[B1101UCLRP](#) [B1201UALRP](#) [B1161UALRP](#) [B1101UALRP](#) [B1101UALTP](#) [B1161UALTP](#) [B1201UALTP](#)
[B1161UCLTP](#) [B1101UCLTP](#) [B1201UCLTP](#) [B1201UCLRP](#) [B1161UCLRP](#) [B1201UATP](#) [B1201UCTP](#) [B1201UCRP](#)
[B1201UARP](#) [B1101UARP](#) [B1101UCTP](#) [B1161UATP](#) [B1101UCRP](#) [B1161UCRP](#) [B1161UCTP](#) [B1101UATP](#)
[B1161UARP](#)