



Intel® Server S2600WF Product Family

Intel® Server Board S2600WF Product Family

Intel® Server Chassis R1000WF and R2000WF Product Families

Intel® Server System R1000WF and R2000WF Product Families

Intel® Server System R2000WFTF Product Family

Configuration Guide

A reference document to identify available Intel® Server building blocks, integrated systems, accessories, and spare parts associated with the Intel® Server S2600WF product family.

Rev 2.5

November 2021

Intel® Server Products and Solutions

<Blank page>

Document Revision History

Date Published	Revision	Revision Change Description
June 2017	1.0	Production release
July 2017	1.1	Updated iPC A2U8X25S3DPDK2 Updated cable kit information for 4 port switch for 1U systems Added 1U and 2U back panel illustrations in section 1.2 and 1.3 Updated A2UHANDLKIT illustration in sections 6 and 7 Added Intel® Visual Compute Accelerators VCA1585LMV in section 8
August 2017	1.2	Updated product ordering information for AXXRMM4LITE2 Updated cables required for second fabric processor with AWF1PFABKITM and AWF1PFABKITP Updated product ordering information for AXXRMFBU6 Updated RAID information in section 5 Updated note for R2000WFXXX description, deleted optical drive support Removed A2UHANDLKIT3 handle Updated SAS drive configuration note Updated 2U system information on hot-swap drive bays F2U12X35S3PH Updated information in table Drive Bay #1, 2 & 3 - SAS / SATA / NVMe* Cable Guide for Switch Add-in Cards Updated RAID information on Intel® Server Board S2600WFT to include Intel® Embedded Server RAID Technology 2 1.60 with optional RAID 5 key support Updated Images: A2U8X25S3DPDK2, A2U8X25S3PHS, A2UREARHSDK2
October 2017	1.3	Added Intel® Server Board S2600WFQ information throughout document Added R2312WFQZS to the section 2U 12 x 3.5" – R2312WFxxx SAS / SATA Data Cable Guide (with No SAS Expander) Added R2312WFQZS to the section 2U 12 x 3.5" – R2312WTxxx SAS / SATA Data Cable Guide (with SAS Expander) Updated 2U systems have three riser card A2UL8RISER2 included on the configuration Updated product ordering information for RSP3MD088F Updated chipset information for S2600WFQ on the table The Intel® Server Board S2600WF family Updated chipset information and notes for Intel® Server Board S2600WFQ Updated order code Information for R2312WFQZS Updated resources in Table 4 Updated image for X527DA40CPG1P5 Updated product name for AXX1300TCRPS Updated label OCP* module note for all 1U and 2U systems Added a note of only S2600WF0 and S2600WFQ support on the quad OCP* expansion modules Added note for AWF1PFABKITM and AWF1PFABKITP Added adjustment note for A1UFULLRAIL, A1USHRTRAIL, AXXFULLRAIL, AXXSHRTRAIL Added 1 x A2UX8X4RISER on the 2U systems: R2312WF0NP, R2312WFTZS, R2312WFQZS, R2224WFQZS, R2224WFTZS Updated SAS/SATA/NVMe* Data Cable Guide section Corrected all 2U system BOMs and product feature reference tables to include third riser card option
October 2017	1.3.1	Corrected kit content definitions for the two IFT Carrier Accessory Kits Added 1U/2U fabric CPU clip accessory kit FXXCPUCLIPF Made additional corrections/clarification to NVMe* cable guide sections. Updated chassis illustrations in cable guide sections

Intel® Server S2600WF Product Family Configuration Guide

Date Published	Revision	Revision Change Description
		Clarified SAS cable support for 1U system configurations that include SAS ROC modules with vertical connectors
December 2017	1.3.2	Corrected NVMe* cable lengths for onboard OCuLink connectors routed to drive bay 1 of 2.5" drive configurations
January 2018	1.4	<p>Added 1U/2U Intel® Virtual Raid on CPU (Intel® VROC) key for Intel® SSD only</p> <p>Added 1U 4 port Switch accessory cable kit A1U4PSWCXCVK</p> <p>Updated information on the table 1U 8 x 2.5" – R1208WFxxx SAS / SATA / NVMe* Data Cable Guide for Switch</p> <p>Updated information for cable AXXCBL850HDHRS</p> <p>Updated Maximum Supported Processor Thermal Design Power (TDP) for Table 6. R2000WF Features</p> <p>Corrected the MM# for A2U8X25S3DPDK2</p> <p>Corrected the MM# for RSP3GD016J</p>
August 2018	1.5	<p>Added R2000WFTF information</p> <p>Added DVDROM drive AXXSATADVDRAM</p> <p>Added DVD+/-RW ROM drive AXXSATADVDRWROM</p> <p>Added 4-port PCIe* SSD retimer AIC AXXP3RTX16040</p> <p>Added accessory cable kit A1U4PRTCXCXK</p> <p>Added accessory cable kit A2U4PRTCXCXK</p> <p>Updated section 4.4, 4.6.1, 4.6.2, 4.7.1.1, 4.7.1.2, and 4.7.3.2</p> <p>Updated MM# for R1208WFTYS, R2308WFTZS, R2208WF0ZS, R2208WFTZS, R2208WFQZS, R2312WF0NP, and R2312WFTZS</p>
December 2018	1.6	<p>Updated RAID websites in section 5.5</p> <p>Updated Table 1 51xx Gold processor memory capacity</p> <p>Updated Table 12 to add for 2.5" NVMe* support for R2312WFQZS</p> <p>Removed the support for up to two NVMe* drives for R2312WFQZS</p> <p>Updated the note in R2312WFQZS product table for optional accessories</p> <p>Updated MM# for FR1UFAN10PW</p> <p>Updated information on the first sentence for Chapter 4 SAS/SATA/NVMe* Data Cable Guide</p> <p>Added R1208WFXXX and R2312WFXXX</p> <p>Updated Table 11. Server chassis (KDK) product family summary</p> <p>Added SATA optical drive power cable and bay mounting kit for R1304WFTYS, R1208WFTYS, R2308WFTZS, R2208WF0ZS, and R2208WFTZS.</p> <p>Updated product description for AXXSATADVDRAM and AXXSATADVDRWROM</p> <p>Edited and formatted for clarity</p>
February 2019	1.7	Added Intel® Server System R1000WFTF product family
April 2019	2.0	<p>Added S2600WFxR information including support for 2nd Gen Intel® Xeon® processor Scalable family and Intel® Optane™ DC persistent memory</p> <p>Updated MM# for R1304WFTYS and R2224WFTZS</p> <p>Added optical cable AXXCBL880SATA</p> <p>Updated formatting and edited for clarity</p> <p>Removed Intel® Server System R1000WFTF product family</p>

Intel® Server S2600WF Product Family Configuration Guide

Date Published	Revision	Revision Change Description
October 2019	2.1	Added spare standard processor clip FXXCPUCLIP Updated section 4.7 – PCIe* Switch Card is now supported on Riser #3 Updated image for AWTAXBBUBKT to clarify RMFBU is not included Corrected AXX750DCCRPS power supply for voltage DC and -48v Updated description for A2U4PRTCXCXK to clarify can be used in R2208+8 (Bay 1 only) Removed A1U4PTRICXCVK cable Removed 2U Hot-Swap 8 x 2.5" Dual-Port Upgrade Drive Bay Kit A2U8X25S3DPDK2 Corrected drive tool less carriers FXX25HSCAR3 for R1208WFXXX, R1208WFTYS, R1208WFTYSR and R1208WFQYSR Updated description for Ethernet Network Adapters for OCP Updated image for AXXCMA2 Updated description for A2U4PSWCXCXK1, A2U4PSWCXCXK2, A2U8PSWCXCXK1, A2U8PSWCXCXK2 and A2U8PSWCXCXK3 Corrected Riser Card Support for Table 8 and Table 9
April 2020	2.2	Corrected MM# for R2208WFTZSR Corrected MM# for RSP3WD080E Corrected MM# for RSP3TD160F Corrected MM# for RSP3DD080F Added A1U4PTRICXCVK version 2 EOL items: MM# 952641, 952644, 952645, 952626, 975884, 975886, 975889, 975888, 975890, 975895, 975887, 975892, 975812, 955877, 955875
August 2020	2.3	Updated Table 60 and 64 with item A2U4PSWCXCXK1 Updated description for A1U4PTRICXCVK Added Cable Kit AXXCBL450HD7S EOL items: MM# 974987, 982901, 974993, 982902, 974990, 982903
February 2021	2.4	Removed PSU 750W DC AXX750DCCRPS EOL Update Table 24, 31, 32 and 34 second Note deleted Update Table 24 R1208WFQYSR updated cables 650mm and 850mm not included Update Table 54 corrected sentence Updated A1U4PTRICXCVK description corrected Minor changes throughout for clarity
November 2021	2.5	Update Table 12 Server System (BIK) Product Family to add R1208WFQYSR Adding RS3P4QF160J and RS3P4GF016J Storage Adapters Adding RS3P4TF160F and RS3P4MF088F RAID Adapters Adding CYPBLSLHDKIT to Table 52 Updating MM# R1304WFXXX, from MM#952622 to 99AWZA

Disclaimers

Intel technologies' features and benefits depend on system configuration and may require enabled hardware, software, or service activation. Performance varies depending on system configuration. No computer system can be absolutely secure. Check with your system manufacturer or retailer or learn more at intel.com.

You may not use or facilitate the use of this document in connection with any infringement or other legal analysis concerning Intel products described herein. You agree to grant Intel a non-exclusive, royalty-free license to any patent claim thereafter drafted which includes subject matter disclosed herein.

No license (express or implied, by estoppel or otherwise) to any intellectual property rights is granted by this document.

The products described may contain design defects or errors known as errata, which may cause the product to deviate from published specifications. Current characterized errata are available on request.

Intel disclaims all express and implied warranties, including without limitation, the implied warranties of merchantability, fitness for a particular purpose, and non-infringement, as well as any warranty arising from course of performance, course of dealing, or usage in trade.

This document contains information on products, services and/or processes in development. All information provided here is subject to change without notice. Contact your Intel representative to obtain the latest Intel product specifications.

Copies of documents that have an order number and are referenced in this document may be obtained by calling 1-800-548-4725 or by visiting www.intel.com/design/literature.htm.

Intel, the Intel logo, Xeon, and Xeon Phi are trademarks of Intel Corporation or its subsidiaries in the U.S. and/or other countries.

*Other names and brands may be claimed as the property of others.

© Intel Corporation

Table of Contents

1. Intel® Server Family Overview	14
1.1 Configuration Overview.....	15
1.1.1 Processor Support.....	16
1.1.2 Memory Support.....	20
1.1.3 System Configuration Notes	20
1.2 Additional Information and Software.....	21
1.3 Intel® Server Board S2600WF Product Family	22
1.4 Intel® Server Board S2600WFTF Product Family.....	25
1.5 Intel® Server System R1000WF Product Family	28
1.6 Intel® Server System R2000WF Product Family	31
1.7 Intel® Server System R2000WFTF Product Family.....	36
1.8 Available Server Board, Chassis, and System SKU Summary	40
2. Server Building Block Options.....	42
2.1 Intel® Server Board S2600WF Product Family Options	44
2.2 Intel® Server Chassis Product Family Options.....	47
3. Server System Configurations	52
3.1 Intel® Server System R1000WF Product Family – (1U Rack Mount System).....	53
3.2 Intel® Server System R2000WF Product Family – (2U Rack Mount System).....	61
4. SAS/SATA/NVMe* Data Cable Guide.....	84
4.1 Cable Connector Types	85
4.2 1U/2U Server System SAS/SATA/NVMe* Cable Kits.....	86
4.2.1 Cable Kit Product Code Decoder Examples.....	87
4.2.2 Cable Kit Order Information	87
4.2.3 Cable Recommendations	93
4.3 1U 4 x 3.5" – R1304WFxxx SAS/SATA Data Cable Guide	94
4.4 1U 8 x 2.5" – R1208WFxxx SAS/SATA/NVMe* Data Cable Guide	95
4.5 2U 8 x 3.5" – R2308WFxxx SAS/SATA Data Cable Guide	96
4.6 2U 12 x 3.5 – R2312WFxxx SAS/SATA/NVMe* Data Cable Guide	97
4.6.1 2U 12 x 3.5" – R2312WFxxx SAS/SATA/NVMe* Data Cable Guide (with no SAS Expander)	97

4.6.2	2U 12 x 3.5" – R2312WTxxx SAS/SATA/NVMe* Data Cable Guide (with SAS Expander)	98
4.7	2U 2.5" Front Mount Drive Bay Cable Guide	100
4.7.1	2U – 8x2.5" Drive Bay Module #1 – Cable Guide (with no SAS Expander).....	101
4.7.2	2U – 8x2.5" Drive Bay Module #2 – Cable Guide (with no SAS Expander).....	104
4.7.3	2U – 8x2.5" Drive Bay Module #3 – Cable Guide (with no SAS Expander).....	106
4.7.4	2U 2.5" Front Mount Drive Configurations – Cable Guide (with SAS Expander).....	109
5.	1U/2U System Optional Accessories	111
5.1	2U Rear Mount Hot Swap Drive Bay Accessory Kits.....	111
5.2	1U/2U PCIe* Riser Card Accessory/Spare FRU Options.....	112
5.2.1	1U Riser Card Options	112
5.2.2	2U Riser Card Options	113
5.3	2U 8x2.5" Drive Bay Module Options.....	114
5.4	Intel® Ethernet Network Adapters for OCP*	116
5.5	Intel® RAID Add-in Cards, Modules, and Accessories	118
5.6	Power Supply Modules and Power Cords	130
5.7	1U/2U Rack Mount Kits	132
6.	1U/2U Miscellaneous Accessory Options	135
7.	1U/2U Spare and Replacement Parts (FRUs)	142
8.	Intel® Visual Compute Accelerators.....	145
Appendix A.	Glossary.....	146

List of Tables

Table 1. 1 st Gen Intel® Xeon® processor Scalable family feature comparison	17
Table 2. 1 st Gen Intel® Xeon® processor Scalable family with integrated Intel® Omni-Path Fabric feature comparison.....	18
Table 3. 2 nd Gen Intel® Xeon® processor Scalable family feature comparison	19
Table 4. Product family reference collaterals	21
Table 5. Intel® Server Board S2600WF product family features	23
Table 6. Intel® Server Board S2600WFTF product family features	26
Table 7. Intel® Server System R1000WF product family features	30
Table 8. Intel® Server System R2000WF product family features	34
Table 9. Intel® Server System R2000WFTF product family features table.....	38
Table 10. Server board product family summary	40
Table 11. Server chassis (KDK) product family summary	40
Table 12. Server system (BIK) product family summary	41
Table 13. Intel® Server Board S2600WF product family options.....	44
Table 14. Intel® Server Chassis R1304WFXXX product specifications and configuration requirements.....	48
Table 15. Intel® Server Chassis R1208WFXXX product specifications and configuration requirements.....	49
Table 16. Intel® Server Chassis R2000WFXXX product specifications and configuration requirements.....	50
Table 17. Intel® Server Chassis R2312WFXXX product specifications and configuration requirements.....	51
Table 18. Intel® Server System R1304WF0YS product specifications and configuration requirements	54
Table 19. Intel® Server System R1304WF0YSR product specifications and configuration requirements	55
Table 20. Intel® Server System R1304WFTYS product specifications and configuration requirements	56
Table 21. Intel® Server System R1304WFTYSR product specifications and configuration requirements	57
Table 22. Intel® Server System R1208WFTYS product specifications and configuration requirements	58
Table 23. Intel® Server System R1208WFTYSR product specifications and configuration requirements	59
Table 24. Intel® Server System R1208WFQYSR product specifications and configuration requirements.....	60
Table 25. Intel® Server System R2308WFTZS product specifications and configuration requirements	62
Table 26. Intel® Server System R2308WFTZSR product specifications and configuration requirements	63
Table 27. Intel® Server System R2208WF0ZS product specifications and configuration requirements	64
Table 28. Intel® Server System R2208WF0ZSR product specifications and configuration requirements.....	65
Table 29. Intel® Server System R2208WFTZS product specifications and configuration requirements	66

Table 30. Intel® Server System R2208WFTZSR product specifications and configuration requirements	67
Table 31. Intel® Server System R2208WFQZS product specifications and configuration requirements.....	68
Table 32. Intel® Server System R2208WFQZSR product specifications and configuration requirements.....	69
Table 33. Intel® Server System LFRB2208WFTF801 product specifications and configuration requirements	70
Table 34. Intel® Server System LFRB2208WFTF601 product specifications and configuration requirements	71
Table 35. Intel® Server System LFRB2208WFTF401 product specifications and configuration requirements	72
Table 36. Intel® Server System R2312WF0NP product specifications and configuration requirements.....	73
Table 37. Intel® Server System R2312WF0NPR product specifications and configuration requirements.....	74
Table 38. Intel® Server System R2312WFTZS product specifications and configuration requirements	75
Table 39. Intel® Server System R2312WFTZSR product specifications and configuration requirements	76
Table 40. Intel® Server System R2312WFQZS product specifications and configuration requirements.....	77
Table 41. Intel® Server System LFRB2312WFTF801 product specifications and configuration requirements	78
Table 42. Intel® Server System LFRB2312WFTF601 product specifications and configuration requirements	79
Table 43. Intel® Server System LFRB2312WFTF401 product specifications and configuration requirements	80
Table 44. Intel® Server System R2224WFQZS product specifications and configuration requirements.....	81
Table 45. Intel® Server System R2224WFTZS product specifications and configuration requirements	82
Table 46. Intel® Server System R2224WFTZSR product specifications and configuration requirements	83
Table 47. Single-port SATA cable connector.....	85
Table 48. Multiport mini SAS HD cable connectors.....	85
Table 49. PCIe* OCuLink cable connectors	85
Table 50. Intel® Omni-Path cable connectors	85
Table 51. Data cable connector identification.....	86
Table 52. SATA/SAS/NVMe* data cable kit description and order information	87
Table 53. Data cable guide for Intel® Server System R1304WFxxx.....	94
Table 54. Data cable guide for Intel® Server System R1208WFxxx.....	95
Table 55. Data cable guide for Intel® Server System R2308WFxxx.....	96
Table 56. Data cable guide (no SAS expander) for Intel® Server System R2312WFxxx.....	97
Table 57. SAS expander option	98
Table 58. Data cable guide (with SAS expander) for Intel® Server System R2312WFxxx	99
Table 59. Drive bay module #1 SAS/SATA cable guide	101
Table 60. Drive bay module #1 NVMe* cable guide.....	102

Table 61. Drive bay module #2 SAS/SATA cable guide	104
Table 62. Drive bay module #2 NVMe* cable guide.....	105
Table 63. Drive bay module #3 SAS/SATA cable guide	106
Table 64. Drive bay module #3 NVMe* cable guide.....	107
Table 65. SAS expander option	109
Table 66. Front mount drive cable guide.....	110
Table 67. 2U rear-mount hot-swap drive bay accessory kits.....	111
Table 68. 1U riser card option.....	112
Table 69. 2U riser card options.....	113
Table 70. 8x2.5" drive bay module accessory kits.....	115
Table 71. Intel® Ethernet Network Adapters for OCP*	117
Table 72. Intel® Integrated RAID module RMS3 product family – SAS 3.0 (12 Gb/s).....	118
Table 73. Intel® RAID controller add-in cards – SAS 3.0 (12 Gb/s)	121
Table 74. Intel® RAID accessory options	126
Table 75. Power supply modules and power cords.....	130
Table 76. Rack mount kits	132
Table 77. Miscellaneous accessory options	135
Table 78. Spare and replacement parts.....	142

List of Figures

Figure 1. Intel® Server S2600WF product family overview	14
Figure 2. Intel® Xeon® processor Scalable family generation identification	16
Figure 3. Intel® Server Board S2600WF onboard features.....	22
Figure 4. Intel® Server Board S2600WFTF onboard features	25
Figure 5. Intel® Server System R1000WF feature set identification	28
Figure 6. 1U, 3.5" x 4 drive configuration (Intel® Server System R1304xxx)	29
Figure 7. 1U, 2.5" x 8 drive configuration (Intel® Server System R1208WFxxx)	29
Figure 8. 1U system back panel	29
Figure 9. Intel® Server System R2000WF feature set identification	31
Figure 10. 2U, No drive bays, chassis only building block (Intel® Server Chassis R2000WFxxx)	32
Figure 11. 2U, 3.5" x 8 drive configuration (Intel® Server System R2308WFxxx).....	32
Figure 12. 2U, 3.5" x 12 drive configuration (Intel® Server System R2312WFxxx – storage configuration)	32
Figure 13. 2U, 2.5" x 8 drive configuration (Intel® Server System R2208WFxxx).....	33
Figure 14. 2U, 2.5" x 16 drive configuration (Intel® Server System R2208WFxxx + 8 drive accessory kit)	33
Figure 15. 2U, 2.5" x 24 drive configuration (Intel® Server System R2224WFxxx – storage configuration)	33
Figure 16. 2U System back panel with optional 2 x 2.5" hot swap drive bay.....	34
Figure 17. Intel® Server System R2000WFTF feature set identification.....	36
Figure 18. 2U, 2.5" x 8 drive configuration (Intel® Server System LFRB2208WFTFxxx).....	37
Figure 19. 2U, 3.5" x 12 drive configuration (Intel® Server System LFRB2312WFTFxxx – storage configuration)	37
Figure 20. System back panel for Intel® Server System R2000WFTF with optional 2 x 2.5" hot-swap drive bay.....	37
Figure 21. Illustration of building block options.....	42
Figure 22. Intel® Server Chassis options	47
Figure 23. Intel® Server System options.....	52
Figure 24. Intel® Server System R1000WF product family	53
Figure 25. R2308WFxxx SAS/SATA backplane (no NVMe* support)	96
Figure 26. R2312WFxxx SAS/SATA backplane (NVMe* support for drive 10 & 11 only).....	97
Figure 27. SAS 3.0 12 Gb/s expander.....	98
Figure 28. 2.5" front mount drive bay and 8 x 2.5" combo hot-swap backplane	100
Figure 29. SAS expander module identification and placement	109

Figure 30. SAS expander port mapping	110
Figure 31. 2U rear-mount hot-swap drive bay accessory.....	111
Figure 32. R2208WF based system with front I/O module bay assembly	114
Figure 33. 2U 2.5" drive identification for each drive bay.....	114
Figure 34. Intel® Ethernet Network Adapter for OCP* installation.....	116

1. Intel® Server Family Overview

This document provides a catalog of available Intel® server products, accessories, and spares in the Intel® Server S2600WF product family.

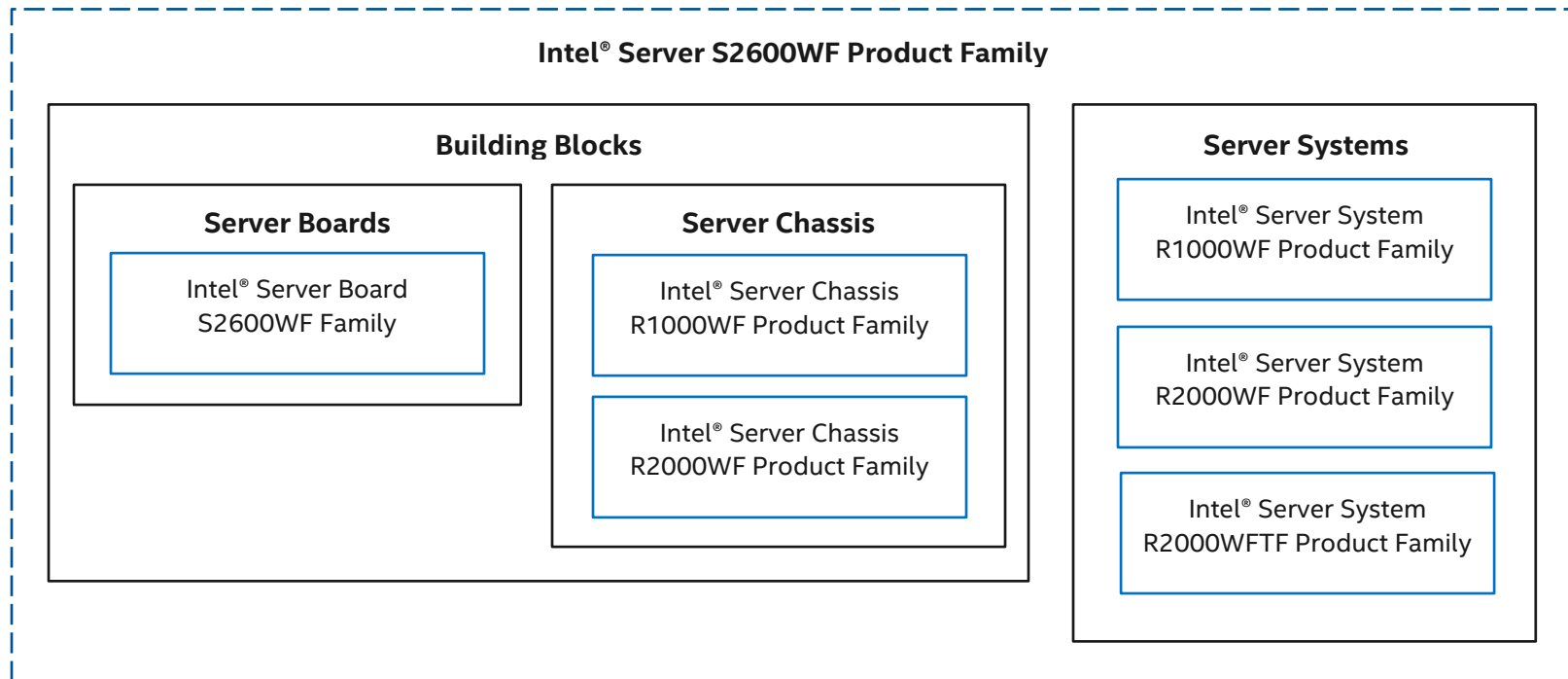


Figure 1. Intel® Server S2600WF product family overview

1.1 Configuration Overview

The Intel® Server S2600WF product family is offered as both building block options and integrated systems.

- Server building blocks:
 - **Intel® Server Board S2600WF family** – A family of server board only products (server building block option and spare FRU).
 - **Intel® Server Chassis R1000WF product family** – A family of 1U rack mount server chassis only products.
 - **Intel® Server Chassis R2000WF product family** – A family of 2U rack mount server chassis only products.
- Integrated server systems:
 - **Intel® Server System R1000WF product family** – A family of 1U rack mount server chassis integrated with an Intel® Server Board S2600WF option.
 - **Intel® Server System R2000WF product family** – A family of 2U rack mount server chassis integrated with an Intel® Server Board S2600WF option.
 - **Intel® Server System R2000WFTF product family** – A family of 2U rack mount server chassis integrated at level L9 with an Intel® Server Board S2600WFTF, processors, and memory.

Important Note: All product order codes ending with 'R' identify new product versions that are available as of revision 2.0 of this document. While product order codes not ending with 'R' may be referenced within this document, only product order codes ending in '(R)' cover both SKU derivations. (i.e. S2600WFT(R) covers S2600WFT and S2600WFTR.)

1.1.1 Processor Support

The Intel® Server S2600WF product family has support for 1st and 2nd Gen Intel® Xeon® processor Scalable family as identified in Figure 2.

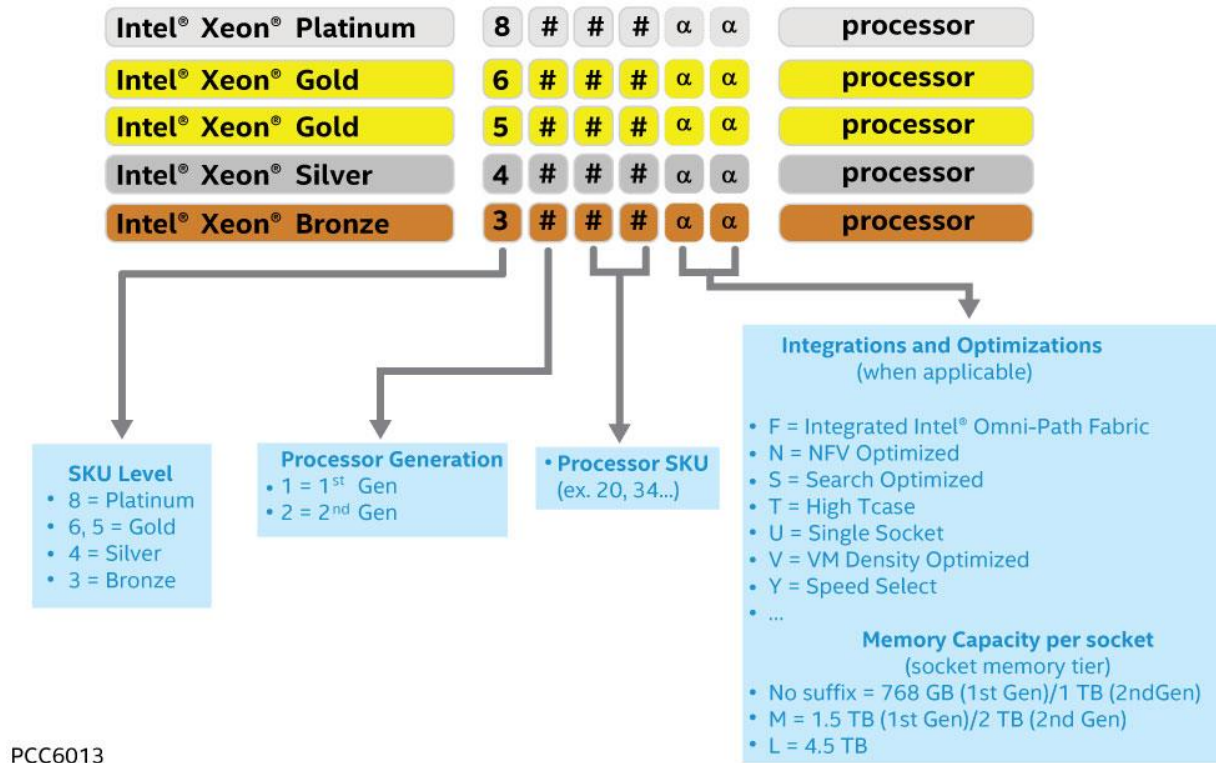


Figure 2. Intel® Xeon® processor Scalable family generation identification

Note: In 2019, Intel released the 2nd Gen Intel® Xeon® processor Scalable family. To enable support for the new processor family, Intel created an updated system software stack including the system BIOS and other system firmware.

In support of the 2nd Gen Intel® Xeon® processor Scalable family, Intel began preloading the supporting system software stack onto all server boards in the Intel® Server S2600WF product family. All server boards with preloaded system software stacks compatible with the 2nd Gen Intel® Xeon® processor Scalable family can be identified by a product order code ending in 'R'.

Existing server boards in the Intel® Server S2600WF product family with product codes that do NOT end in 'R' can be made to support the 2nd Gen Intel® Xeon® processor Scalable family by updating the system software stack. A system update package (SUP) with the latest system software stack can be downloaded from <https://downloadcenter.intel.com>.

The Intel® Server Board S2600WFTF has support for the following Intel® Xeon® processor Scalable family processors:

- Intel® Xeon® Silver 4106H processor
- Intel® Xeon® Gold 6130H processor
- Intel® Xeon® Platinum 8160H processor

Note: Previous generation Intel® Xeon® processors and previous-generation processor heat sinks are not compatible on server boards described in this document.

Table 1. 1st Gen Intel® Xeon® processor Scalable family feature comparison

Feature	81xx Platinum	61xx Gold	51xx Gold	41xx Silver	31xx Bronze
# of Intel® UPI links	3	3	2	2	2
Intel® UPI speed	10.4 GT/s	10.4 GT/s	10.4 GT/s	9.6 GT/s	9.6 GT/s
Supported topologies	2S-2UPI 2S-3UPI 4S-2UPI 4S-3UPI 8S-3UPI	2S-2UPI 2S-3UPI 4S-2UPI 4S-3UPI	2S-2UPI 4S-2UPI	2S-2UPI	2S-2UPI
Node controller support	Yes	Yes	No	No	No
# of memory channels	6	6	6	6	6
Max DDR4 speed	2666 MT/s	2666 MT/s	2400 MT/s	2400 MT/s	2133 MT/s
Memory capacity	768 GB 1.5 TB (select SKUs)	768 GB 1.5 TB (select SKUs)	768 GB	768 GB	768 GB
RAS capability	Advanced	Advanced	Advanced	Standard	Standard
Intel® Turbo Boost Technology	Yes	Yes	Yes	Yes	No
Intel® Hyper-Threading Technology	Yes	Yes	Yes	Yes	No
Intel® AVX-512 ISA support	Yes	Yes	Yes	Yes	Yes
Intel® AVX-512 – # of 512b FMA units	2	2	1	1	1
# of PCIe* lanes	48	48	48	48	48

Table 2. 1st Gen Intel® Xeon® processor Scalable family with integrated Intel® Omni-Path Fabric feature comparison

Feature	81xxF Platinum	61xxF Gold
# of cores	≥ 24	< 24
# of Intel® Omni-Path Fabric ports	1	1
# of Intel® UPI links	2	2
Intel® UPI speed	10.4 GT/s	10.4 GT/s
Supported topologies	2S-2UPI	2S-2UPI
Node controller support	No	No
# of memory channels	6	6
Max DDR4 speed	2666 MT/s	2666 MT/s
Memory capacity	768 GB 1.5 TB (select SKUs)	768 GB 1.5 TB (select SKUs)
RAS capability	Standard	Standard
Intel® Turbo Boost Technology	Yes	Yes
Intel® Hyper-Threading Technology	Yes	Yes
Intel® AVX-512 ISA support	Yes	Yes
Intel® AVX-512 – # of 512b FMA units	2	2
# of PCIe* lanes	48	48

Table 3. 2nd Gen Intel® Xeon® processor Scalable family feature comparison

Feature	82xx Platinum	62xx Gold	52xx Gold	42xx Silver	32xx Bronze
# of Intel® UPI links	3	3	2	2	2
Intel® UPI speed	10.4 GT/s	10.4 GT/s	10.4 GT/s	9.6 GT/s	9.6 GT/s
Supported topologies	2S-2UPI 2S-3UPI 4S-2UPI 4S-3UPI 8S-3UPI	2S-2UPI 2S-3UPI 4S-2UPI 4S-3UPI	2S-2UPI 4S-2UPI	2S-2UPI	2S-2UPI
Node controller support	Yes	Yes	No	No	No
# of memory channels	6	6	6	6	6
Max DDR4 speed (1 DPC)	2933 MT/s	2933 MT/s	2666 MT/s	2400 MT/s	2133 MT/s
Max DDR4 speed (2 DPC)	2666 MT/s	2666 MT/s	2666 MT/s	2400 MT/s	2133 MT/s
Intel® Optane™ DC persistent memory support	Yes ¹	Yes ¹	Yes ¹	4215 only ¹	No
Memory capacity	1 TB 2 TB (select SKUs) 4.5 TB (select SKUs)	1 TB 2 TB (select SKUs) 4.5 TB (select SKUs)	1 TB 2 TB (select SKUs) 4.5 TB (select SKUs)	1 TB	1 TB
RAS capability	Advanced	Advanced	Advanced	Standard	Standard
Intel® Turbo Boost Technology	Yes	Yes	Yes	Yes	No
Intel® Hyper-Threading Technology	Yes	Yes	Yes	Yes	No
Intel® AVX-512 ISA support	Yes	Yes	Yes	Yes	Yes
Intel® AVX-512 – # of 512b FMA units	2	2	1	1	1
Intel® AVX-512 VNNI	Yes	Yes	Yes	Yes	Yes
# of PCIe* lanes	48	48	48	48	48

¹ Intel® Optane™ DC persistent memory module is supported only by Intel® Server Boards S2600WFTR, S2600WF0R, and S2600WFQR with a 2nd Gen Intel® Xeon® Scalable processor.

1.1.2 Memory Support

The Intel® Server Board S2600WF product family has support for the following memory:

- Registered DDR4 (RDIMM), Load Reduced DDR4 (LRDIMM)
- Memory data transfer rates (Processor dependent. See Table 1, Table 2, and Table 3.)
 - DDR4 ECC RDIMM up to 2933 MT/s
 - DDR4 ECC LRDIMM up to 2933 MT/s
 - DDR4-compatible DDDC Intel® Optane™ DC persistent memory module up to 2666 MT/s
- DDR4 standard voltage of 1.2 V

Note: Intel® Optane™ DC persistent memory module is supported only by Intel® Server Boards S2600WFTR, S2600WF0R, and S2600WFQR with a 2nd Gen Intel® Xeon® Scalable processor.

The Intel® Server Board S2600WFTF product family has support for the following memory:

- Registered DDR4 (RDIMM), Load Reduced DDR4 (LRDIMM)
- Memory data transfer rates (Processor dependent. See Table 1 and Table 2.)
 - DDR4 ECC RDIMM up to 2666 MT/s
 - DDR4 ECC LRDIMM up to 2666 MT/s
- DDR4 standard voltage of 1.2 V

1.1.3 System Configuration Notes

- Single processor configurations require the processor to be installed in the processor #1 socket.
- Processor #2 must be installed to use any of its 12 associated DIMM slots.
- To ensure systems meet necessary airflow and thermal requirements, the processor #2 heat sink must be installed at all times, with or without a processor present.
- Support for riser card slots 2 and 3 requires that two processors be installed.
- Riser card slots 1 and 2 can provide a maximum power of 75 W to each installed riser card. PCIe* add-in cards that require more power than is available directly from the riser card must route the additional power directly to the add-in card from either of the two onboard 12V auxiliary power connectors using a 12V-AUX Power Cable available as a stand-alone accessory (AXXGPGPUCABLE) or included with some riser card accessory kits.

1.2 Additional Information and Software

For additional information about this family of products or any of their supported accessories, refer to the following resources available at <http://www.intel.com/support>.

Table 4. Product family reference collaterals

For this information or software	Use this document or software
For in-depth technical information about this product family	<i>Intel® Server Board S2600WF Technical Product Specification</i> <i>Intel® Server System R1000WF Product Family Technical Product Specification</i> <i>Intel® Server System R2000WF Product Family Technical Product Specification</i> <i>Intel® Server System R2000WFTF Product Family Technical Product Specification</i> <i>Intel® Remote Management Module 4 (Intel® RMM4) and BMC Embedded Web Console User Guide</i> <i>Intel® Remote Management Module 4 Technical Product Specification</i> <i>Intel® Server System BIOS Setup Utility Guide</i> <i>Intel® Server System R2000WFTF IPTrak PIT Users Guide</i> <i>Intel® Server Platform Specification Update</i> <i>Safety and Regulatory Compliance Information for Intel® Server System 4600/2600/2400/1600 Families</i>
For system integration and service instructions	<i>Intel® Server System R1000WF Product Family System Integration and Service Guide</i> <i>Intel® Server System R2000WF Product Family System Integration and Service Guide</i> <i>Intel® Server System R2000WFTF Product Family System Integration and Service Guide</i>
For server configuration guidance and compatibility	Intel® Server Configurator Tool (http://serverconfigurator.intel.com/)
For system firmware updates, onboard device drivers, and software	Download Center (https://downloadcenter.intel.com/search?keyword=S2600WF)
For system power budget guidance	Intel® Server Board S2600WF Product Family Power Budget and Thermal Configuration Tool (https://downloadcenter.intel.com/download/28836/)
For a complete list of supported processors, memory, add-in cards, and peripherals	Intel® Server Board S2600WF family support site (https://www.intel.com/content/www/us/en/support/server-products/server-boards/dual-socket-server-boards/intel-server-board-s2600wf-family.html)
Product warranty Information	Warranty Terms and Conditions (https://www.intel.com/content/www/us/en/support/services/000005886.html)

1.3 Intel® Server Board S2600WF Product Family

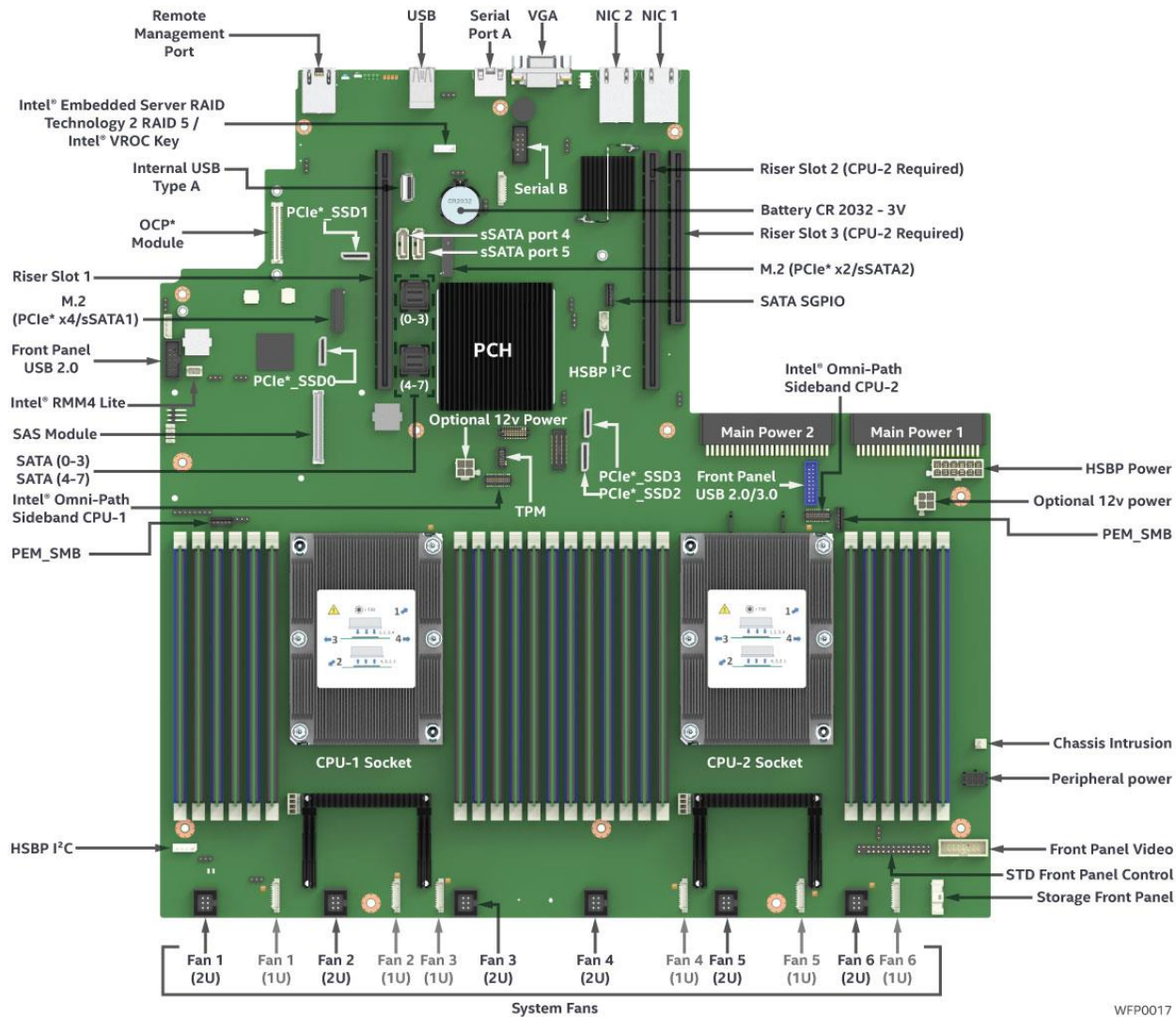


Figure 3. Intel® Server Board S2600WF onboard features

WFP0017

Note: Figure 3 provides an overview of available server board features. Some features may not be present on all available server board options. See Table 5 for a complete list of features supported on a given server board option.

Table 5 lists the features of the available server boards in the Intel® Server Board S2600WF product family.

Table 5. Intel® Server Board S2600WF product family features

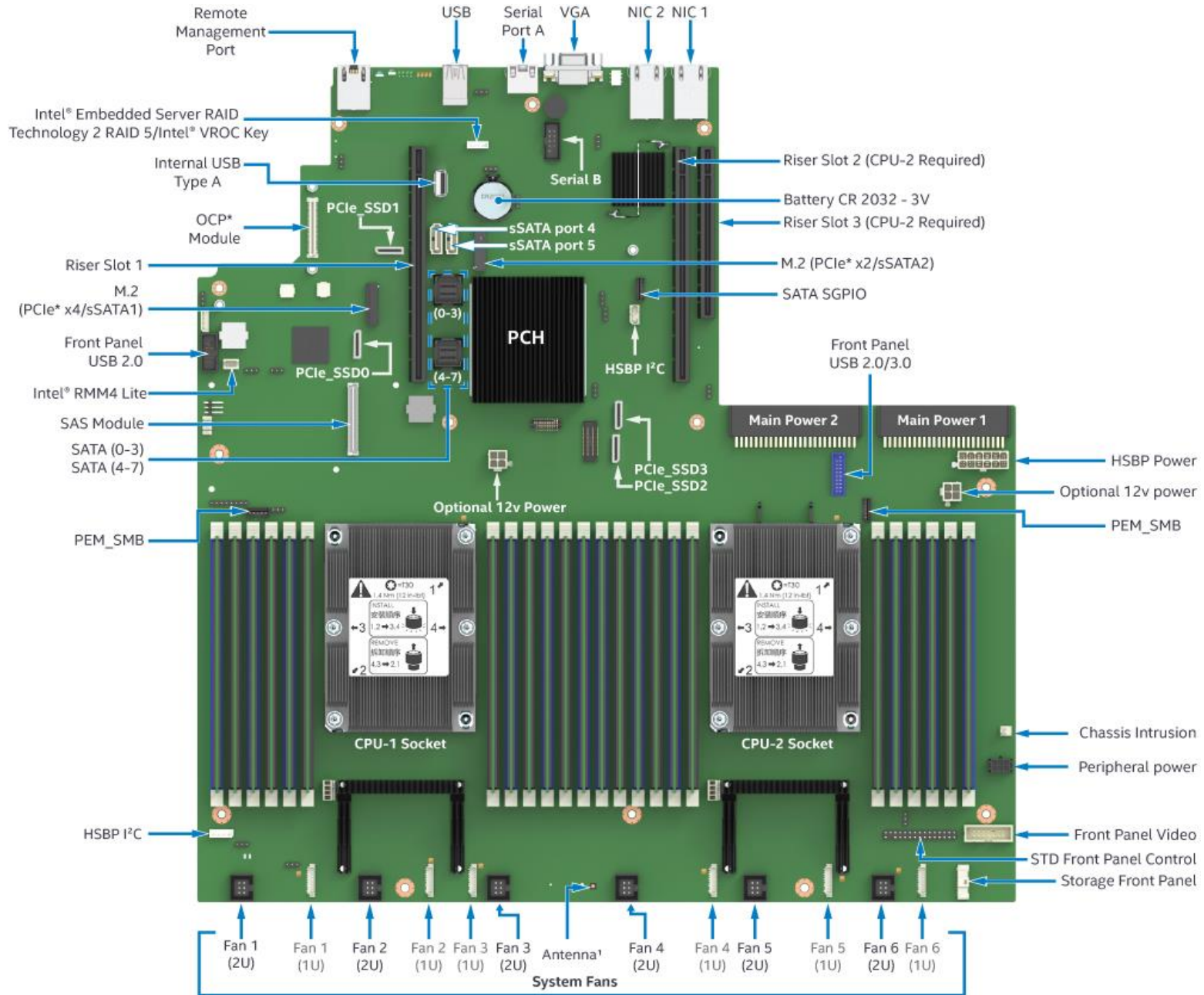
Intel® Server Board Feature	S2600WFT(R)	S2600WF0(R)	S2600WFQ(R)
Processor	<ul style="list-style-type: none"> • (2) – LGA3647-0 (Socket P) processor sockets • Supports (1) or (2) processors from the 1st or 2nd Gen Intel® Xeon® processor Scalable family (Platinum, Gold, Silver, and Bronze). Note: Previous generation Intel® Xeon® processors are not supported. • Maximum supported Thermal Design Power (TDP) of up to 205 W (board only) Note: Intel® Server Systems based on this server board family may support a lower maximum Thermal Design Power (TDP). See the appropriate Intel® System TPS for maximum supported TDP.		
Memory	<ul style="list-style-type: none"> • (24) – total DIMM slots (12 per processor) <ul style="list-style-type: none"> ◦ (6) – memory channels per processor ◦ (2) – DIMMs per channel • DDR4 Registered DIMM (RDIMM) and Load Reduced DIMM (LRDIMM), up to 2933 MT/s (dependent on processor), 1.2 V • DDR4-compatible Intel® Optane™ DC persistent memory module, up to 2666 MT/s, 1.2 V¹ 		
Intel® C62x Series Chipset	Intel® C624 Chipset	Intel® C624 Chipset	Intel® C628 Chipset
Intel® QAT	No	No	Supported
Intel® Omni-Path Fabric	Supported	Supported	Supported
Onboard LAN	Dual Port RJ45 10 GbE	No	No
OCP* Module Support	<ul style="list-style-type: none"> • Dual Port 10Gb RJ45 – iPC 557T2OCPG1P5 • Dual Port SFP+ – iPC 527DA2OCPG1P5 	<ul style="list-style-type: none"> • Quad Port 1Gb RJ45 – iPC I357T4OCPG1P5 • Quad Port SFP+ – iPC X527DA4OCPG1P5 • Dual Port 10Gb RJ45 – iPC X557T2OCPG1P5 • Dual Port SFP+ – iPC X527DA2OCPG1P5 	<ul style="list-style-type: none"> • Quad Port 1Gb RJ45 – iPC I357T4OCPG1P5 • Quad Port SFP+ – iPC X527DA4OCPG1P5 • Dual Port 10Gb RJ45 – iPC X557T2OCPG1P5 • Dual Port SFP+ – iPC X527DA2OCPG1P5
Intel® Integrated SAS Module	Supported	Supported	Supported
Onboard PCIe* NVMe*	<ul style="list-style-type: none"> • (4) – OCuLink connectors • Intel® VMD support • Intel® RSTe/Intel® VROC support (accessory option) 	<ul style="list-style-type: none"> • (4) – OCuLink connectors • Intel® VMD support • Intel® RSTe/Intel® VROC support (accessory option) 	<ul style="list-style-type: none"> • (2) – OCuLink connectors • Intel® VMD support • Intel® RSTe/Intel® VROC support (accessory option)
Onboard SATA	<ul style="list-style-type: none"> • (12) – SATA 6 Gbps ports (6 Gb/s, 3 Gb/s and 1.5 Gb/s transfer rates supported) <ul style="list-style-type: none"> ◦ (2) – single port 7-pin SATA connectors ◦ (2) – M.2 connectors – SATA/PCIe* ◦ (2) – 4-port mini-SAS HD (SFF-8643) connectors • Embedded SATA Software RAID <ul style="list-style-type: none"> ◦ Intel® RSTe 5.0 ◦ Intel® Embedded Server RAID Technology 2 1.60 with optional RAID 5 key support 		<ul style="list-style-type: none"> • (4) – SATA 6 Gbps ports (6 Gb/s, 3 Gb/s and 1.5 Gb/s transfer rates supported) <ul style="list-style-type: none"> ◦ (2) – single port 7-pin SATA connectors ◦ (2) – M.2 connectors – SATA/PCIe* • Embedded SATA Software RAID <ul style="list-style-type: none"> ◦ Intel® RSTe 5.0 Note: 4-port mini-SAS HD connectors are present on S2600WFQ but are not configured as SATA; these cables are used only for Intel® QAT.
Riser Card	Concurrent support for up to three riser cards <ul style="list-style-type: none"> • Riser #1 – PCIe* 3.0 x24 (CPU1 x16, CPU2 x8) – 2 and 3 slot riser card options available • Riser #2 – PCIe* 3.0 x24 (CPU2 x24) – 2 and 3 slot riser card options available • Riser #3 (2U systems only) – PCIe* 3.0 (CPU 2 x12) – 2 slot riser card available 		

Intel® Server S2600WF Product Family Configuration Guide

Intel® Server Board Feature	S2600WFT(R)	S2600WF0(R)	S2600WFQ(R)
Video	<ul style="list-style-type: none"> • Integrated 2D video controller • 16MB of DDR4 video memory • (1) – DB-15 external connector • (1) – 14-pin internal connector for optional front panel video support 		
USB	<ul style="list-style-type: none"> • (3) – external USB 3.0 ports • (1) – internal type-A USB 2.0 port • (1) – internal 20-pin connector for optional 2x USB 3.0 port front panel support • (1) – internal 10-pin connector for optional 2x USB 2.0 port front panel support 		
Serial Port	<ul style="list-style-type: none"> • (1) – external RJ-45 serial-A port connector • (1) – internal DH-10 serial-B port header for optional front or rear serial port support 		
Server Management	<ul style="list-style-type: none"> • Integrated baseboard management controller, IPMI 2.0 compliant • Support for Intel® Server Management software • Dedicated onboard RJ45 management port • Advanced server management via Intel® RMM4 Lite – iPC AXXRMM4LITE2 (accessory option) 		
Security	<ul style="list-style-type: none"> • Trusted platform module 2.0 (Rest of World) – iPC AXXTPMENC8 (accessory option) • Trusted platform module 2.0 (China Version) – iPC AXXTPMCHNE8 (accessory option) 		
System Fan	<ul style="list-style-type: none"> • (6) – system fans supported in two different connector formats: hot swap (2U) and cabled (1U) <ul style="list-style-type: none"> ○ (6) – 10-pin managed system fan headers (sys_fan 1–6) – used for 1U system configuration ○ (6) – 6-pin hot swap capable managed system fan connectors (sys_fan 1–6) – used for 2U system configuration 		

1 Intel® Optane™ persistent memory module is supported only by Intel® Server Boards S2600WFTR, S2600WF0R, and S2600WFQR with 2nd Gen Intel® Xeon® Scalable processor.

1.4 Intel® Server Board S2600WFTF Product Family



1. This feature is available only for Intel® Server Board S2600WFTF product family

Figure 4. Intel® Server Board S2600WFTF onboard features

Table 6. Intel® Server Board S2600WFTF product family features

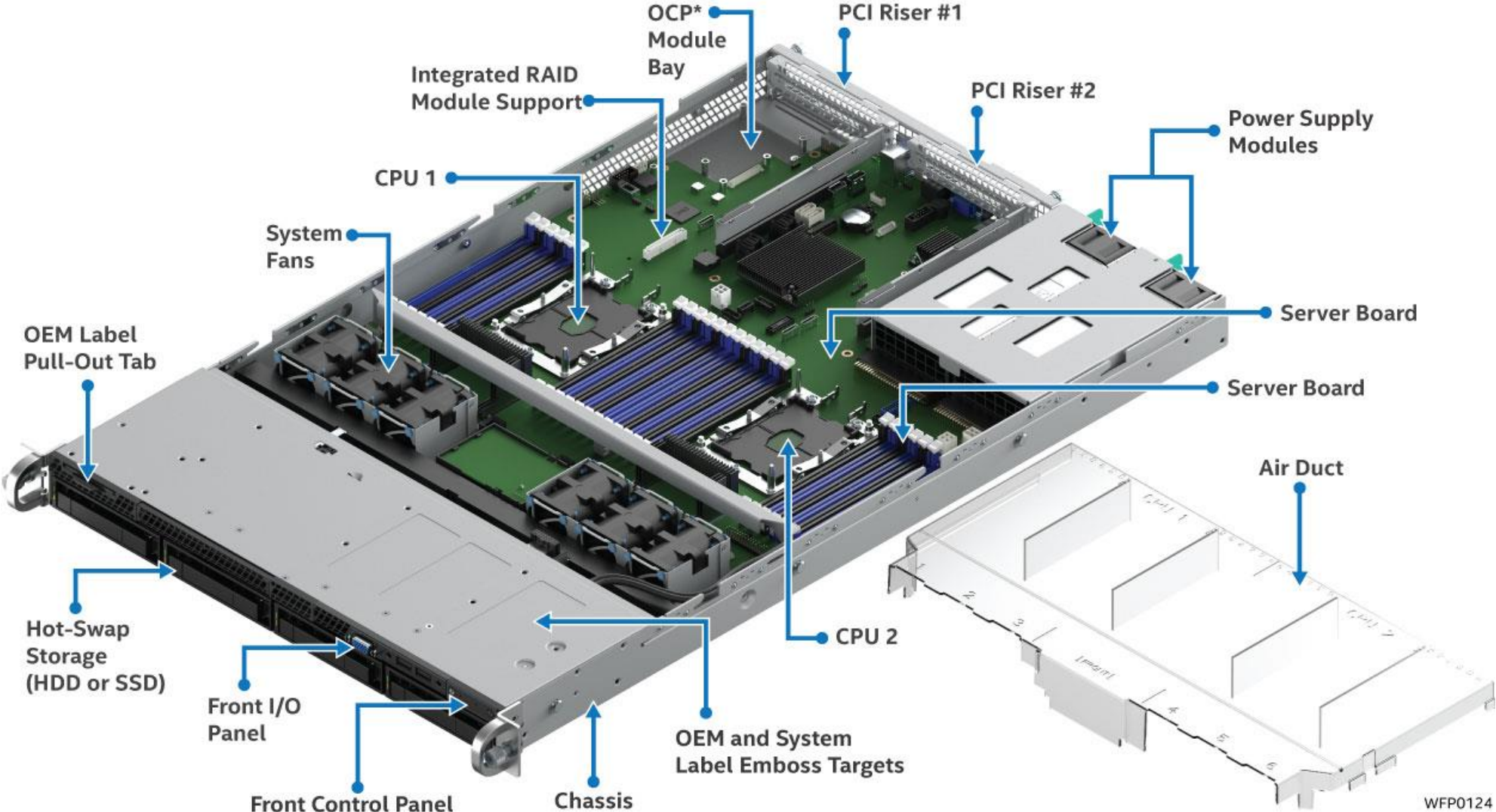
Intel® Server Board Feature	Description
Processor	<ul style="list-style-type: none"> • (2) – LGA3647-0 (Socket P) processor sockets • Supports (1) or (2) of the following processors from the Intel® Xeon® processor Scalable family <ul style="list-style-type: none"> ○ Intel® Xeon® Silver 4106H processor ○ Intel® Xeon® Gold 6130H processor ○ Intel® Xeon® Platinum 8160H processor
Memory	<ul style="list-style-type: none"> • (24) – total DIMM slots (12 per processor) <ul style="list-style-type: none"> ○ (6) – memory channels per processor ○ (2) – DIMMs per channel • Registered DDR4 (RDIMM), Load Reduced DDR4 (LRDIMM) • Memory data transfer rates up to 2666 MT/s (dependent on processor) • DDR4 standard voltage of 1.2 V
Intel® C62x Series Chipset	Intel® C624 Chipset
Intel® Platform Firmware Resilience	Yes
Protect-in-Transit	Yes
Intel® Quick Assist Technology	No
Intel® Omni-Path Fabric Support	No
Onboard LAN	Dual Port RJ45 10GbE
OCP* Module Support	<ul style="list-style-type: none"> • Dual Port 10Gb RJ45 – iPC 557T2OCPG1P5 • Dual Port SFP+ – iPC 527DA2OCPG1P5
Intel® Integrated SAS Module	Supported
Onboard PCIe* NVMe* Support	<ul style="list-style-type: none"> • (4) – OCUlink connectors • Intel® VMD support • Intel® RSTe/Intel® VROC support (accessory option)
Onboard SATA	<ul style="list-style-type: none"> • (12) – SATA 6 Gbps ports (6 Gb/s, 3 Gb/s and 1.5 Gb/s transfer rates supported) <ul style="list-style-type: none"> ○ (2) – single port 7-pin SATA connectors ○ (2) – M.2 connectors – SATA / PCIe* ○ (2) – 4-port mini-SAS HD (SFF-8643) connectors • Embedded SATA Software RAID <ul style="list-style-type: none"> ○ Intel® RSTe 5.0 ○ Intel® Embedded Server RAID Technology 2 1.60 with optional RAID 5 key support
Riser Card	<p>Concurrent support for up to three riser cards</p> <ul style="list-style-type: none"> • Riser #1 – PCIe* 3.0 x24 (CPU1 x16, CPU2 x8) – 2 and 3 slot riser card options available • Riser #2 – PCIe* 3.0 x24 (CPU2 x24) – 2 and 3 slot riser card options available • Riser #3 (2U systems only) – PCIe* 3.0 (CPU 2 x12) – 2 slot riser card available (low-profile add-in cards only)
Video	<ul style="list-style-type: none"> • Integrated 2D video controller • 16MB of DDR4 video memory • (1) – DB-15 external connector • (1) – 14-pin internal connector for optional front panel video support

Intel® Server S2600WF Product Family Configuration Guide

Intel® Server Board Feature	Description
USB Support	<ul style="list-style-type: none"> • (3) – external USB 3.0 ports • (1) – internal type-A USB 2.0 port • (1) – internal 20-pin connector for optional 2x USB 3.0 port front panel support • (1) – internal 10-pin connector for optional 2x USB 2.0 port front panel support
Serial Port Support	<ul style="list-style-type: none"> • (1) – external RJ-45 serial-A port connector • (1) – internal DH-10 serial-B port header for optional front or rear serial port support
Server Management	<ul style="list-style-type: none"> • Integrated baseboard management controller, IPMI 2.0 compliant • Support for Intel® Server Management software • Dedicated onboard RJ45 management port • Advanced server management via Intel® RMM4 Lite – iPC AXXRMM4LITE2 (accessory option)
Security	<ul style="list-style-type: none"> • Trusted platform module 2.0 (Rest of World) – iPC AXXTPMENC8 (accessory option) • Trusted platform module 2.0 (China Version) – iPC AXXTPMCHNE8 (accessory option)
System Fan	<ul style="list-style-type: none"> • (6) – system fans supported in two different connector formats: hot swap (2U) and cabled (1U) • (6) – 10-pin managed system fan headers (sys_fan 1–6) – used for 1U system configuration • (6) – 6-pin hot swap capable managed system fan connectors (sys_fan 1–6) – used for 2U system configuration
Antenna Support	RFID near field antenna, I-PEX connector

1.5 Intel® Server System R1000WF Product Family

This section gives an overview of the available systems in the Intel® Server System R1000WF product family. The “xxx” notation defines the specific product model or code. For complete configuration details, see Section 3.1.



WFP0124

Figure 5. Intel® Server System R1000WF feature set identification



Figure 6. 1U, 3.5" x 4 drive configuration (Intel® Server System R1304xxx)



Figure 7. 1U, 2.5" x 8 drive configuration (Intel® Server System R1208WFxxx)



Figure 8. 1U system back panel

Table 7. Intel® Server System R1000WF product family features

Feature	Description
Chassis Type	1U rack mount chassis
Server Board	Intel® Server Board S2600WF product family
Maximum Supported Processor Thermal Design Power (TDP)	Up to 165 W Note: Intel® Server Systems in this family may support a lower maximum Thermal Design Power (TDP). See the appropriate Intel® System TPS for maximum supported TDP.
External I/O Connections	<ul style="list-style-type: none"> • DB-15 video connectors <ul style="list-style-type: none"> ○ Front and back • RJ-45 serial port A connector on back panel • Dual RJ-45 network interface connectors (S2600WFT-based systems only) • Dedicated RJ-45 server management port on back panel • (3) – USB 3.0 connectors on back panel • (2) – USB 3.0 connectors on front panel (non-storage system configurations only)
Internal I/O Connectors/Headers	<ul style="list-style-type: none"> • (1) – Type-A USB 2.0 connector • (1) – DH-10 serial port B connector
System Fans	<ul style="list-style-type: none"> • (6) – managed 40 mm dual rotor system fans • One power supply fan for each installed power supply module
Riser Card Support	<p>Support for two riser cards:</p> <ul style="list-style-type: none"> • Riser #1 – PCIe* 3.0 x24 • Riser #2 – PCIe* 3.0 x24 <p>With two riser cards installed, up to two possible add-in cards can be supported (one x16 PCIe* 3.0 add-in card slot per riser card):</p> <ul style="list-style-type: none"> • (2) full height/half-length add-in cards via Risers #1 and #2
Power Supply Options	<p>The server system can have up to two power supply modules installed, supporting the following power configurations: 1+0, 1+1 redundant power, and 2+0 combined power.</p> <p>(3) power supply options:</p> <ul style="list-style-type: none"> • AC 1100 W Platinum • AC 1300 W Platinum • DC 750 W Gold
Drive Bay Options	<ul style="list-style-type: none"> • Hot-swap backplane options: <ul style="list-style-type: none"> ○ 4 x 3.5" SAS/SATA backplane ○ 8 x 2.5" combo backplane – SAS/SATA/NVMe <p>Note: All available backplane options have support for SAS 3.0 (12 Gb/sec).</p> <ul style="list-style-type: none"> • Storage bay options: <ul style="list-style-type: none"> ○ 4 x 3.5" SAS/SATA hot swap drive bays + front panel I/O ○ 8 x 2.5" SAS/SATA/NVMe* hot swap drive bays + front panel I/O
Supported Rack Mount Kit Accessory Options	<ul style="list-style-type: none"> • AXXELVRAIL – Enhanced value rack mount rail kit – 424 mm max travel length, 59 kg max supported weight • A1UFULLRAIL – 1U premium rail kit with CMA support – 780 mm max travel length, 18 kg max supported weight • A1USHRTRAIL – 1U premium rail kit without CMA support – 780 mm max travel length, 18 kg max supported weight • AXX2POSTBRCKT – Two post fixed mount bracket kit • AXX1U2UCMA2– Cable management arm (CMA) (supported with AXXFULLRAIL only)

1.6 Intel® Server System R2000WF Product Family

This section gives an overview of the available systems in the Intel® Server System R2000WF product family. The “xxx” notation defines the specific product model or code. For complete configuration details, see Section 3.2.

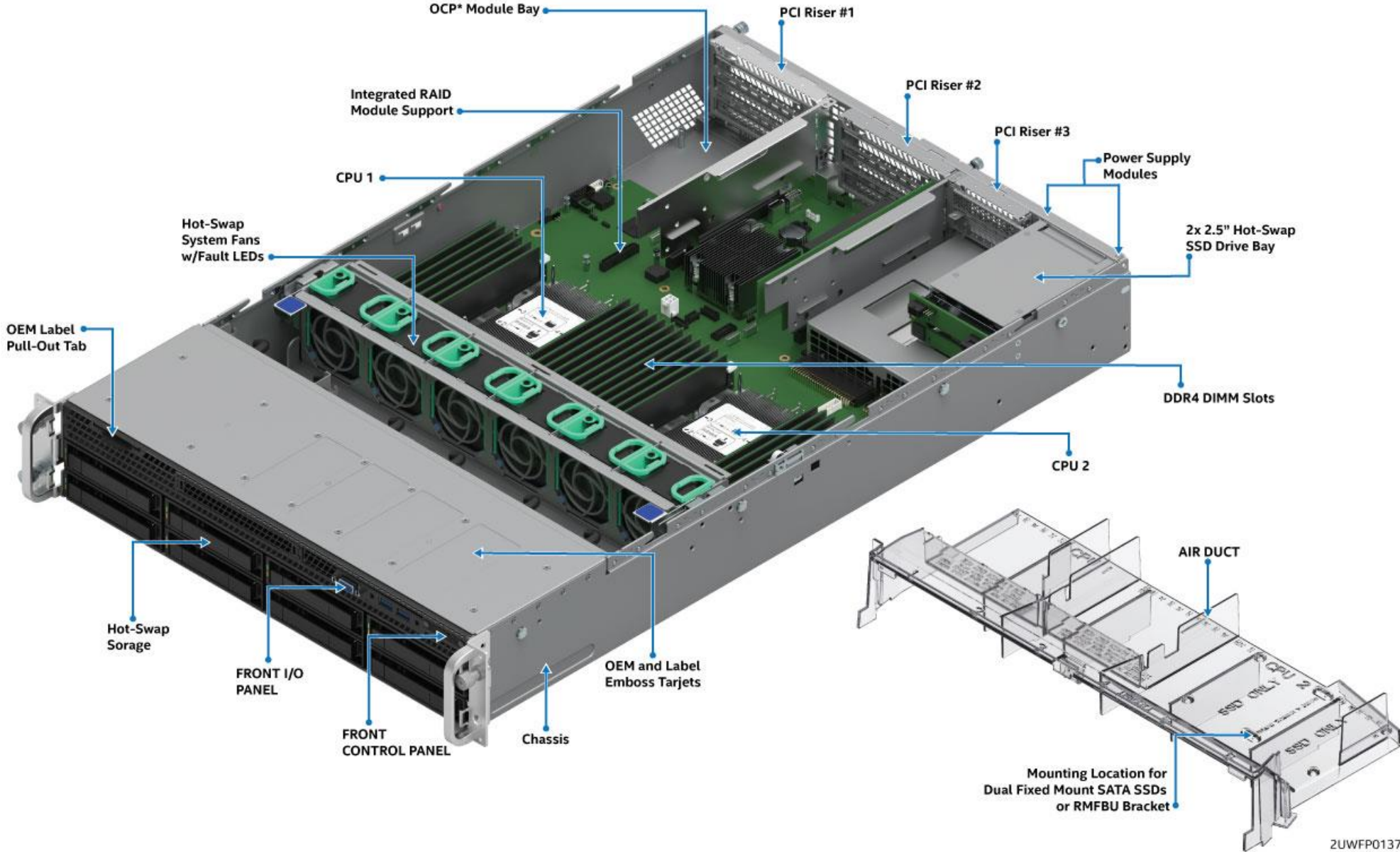


Figure 9. Intel® Server System R2000WF feature set identification

ZUWFP0137



2UWFP087

Figure 10. 2U, No drive bays, chassis only building block (Intel® Server Chassis R2000WFxxx)



Figure 11. 2U, 3.5" x 8 drive configuration (Intel® Server System R2308WFxxx)



Figure 12. 2U, 3.5" x 12 drive configuration (Intel® Server System R2312WFxxx – storage configuration)



Figure 13. 2U, 2.5" x 8 drive configuration (Intel® Server System R2208WFxxx)



Figure 14. 2U, 2.5" x 16 drive configuration (Intel® Server System R2208WFxxx + 8 drive accessory kit)



Figure 15. 2U, 2.5" x 24 drive configuration (Intel® Server System R2224WFxxx – storage configuration)



Figure 16. 2U System back panel with optional 2 x 2.5" hot swap drive bay

Table 8 describes the features of the 2U server system configurations. Storage system configurations include R2312WFxxxx and R2224WFxxxx. Non-storage system configurations include R2308WFxxxx, R2208WFxxxx, and R2208WFxxxx +8 (base 8 drive system with 8 drive add-in module).

Table 8. Intel® Server System R2000WF product family features

Feature	Description
Chassis Type	2U rack mount chassis
Server Board	Intel® Server Board S2600WF product family
Maximum Supported Processor Thermal Design Power (TDP)	Up to 205 W Note: Intel® Server Systems in this family may support a lower maximum Thermal Design Power (TDP). See the appropriate Intel® System TPS for maximum supported TDP.
External I/O Connections	<ul style="list-style-type: none"> • DB-15 video connectors <ul style="list-style-type: none"> ○ Front and back (non-storage system configurations only) • RJ-45 serial port A connector • Dual RJ-45 network interface connectors (S2600WFT-based systems only) • Dedicated RJ-45 server management NIC • (3) – USB 3.0 connectors on back panel • (2) – USB 3.0 connectors on front panel (non-storage system configurations only) • (1) – USB 2.0 connector on rack handle (storage configurations only)
Internal I/O Connectors/Headers	<ul style="list-style-type: none"> • (1) – Type-A USB 2.0 connector • (1) – DH-10 serial port B connector
System Fans	<ul style="list-style-type: none"> • (6) – managed 60 mm hot swap capable system fans • Integrated fans included with each installed power supply module

Feature	Description
Riser Card Support	<p>Support for three riser cards:</p> <ul style="list-style-type: none"> • Riser #1 – PCIe* 3.0 x24 – up to 3 PCIe* slots • Riser #2 – PCIe* 3.0 x24 – up to 3 PCIe* slots • Riser #3 – PCIe* 3.0 x16 – up to 2 PCIe* slots – Low profile cards only (optional) <p>With three riser cards installed, up to eight possible add-in cards can be supported:</p> <ul style="list-style-type: none"> • (4) full height/full-length + (2) full height/half-length add-in cards via Risers #1 and #2 • (2) low profile add-in cards via riser #3 (option)
Power Supply Options	<p>The server system can have up to two power supply modules installed, supporting the following power configurations: 1+0, 1+1 redundant power, and 2+0 combined power.</p> <ul style="list-style-type: none"> • (3) power supply options: <ul style="list-style-type: none"> ○ AC 1100 W Platinum ○ AC 1300 W Titanium ○ DC 750 W Gold
Drive Bay Options	<ul style="list-style-type: none"> • Hot-swap backplane options: <ul style="list-style-type: none"> ○ 8 x 3.5" SAS/ SATA ○ 8 x 2.5" combo backplane – SAS/SATA/NVMe* ○ 12 x 3.5" SAS/ SATA (supports up to 2 NVMe* drives) <p>Note: All available backplane options have support for SAS 3.0 (12 Gb/sec).</p> <ul style="list-style-type: none"> • Storage bay options: <ul style="list-style-type: none"> ○ 8 x 3.5" SAS/SATA hot swap drive bays ○ 12 x 3.5" SAS/SATA hot swap drive bays (supports up to 2 NVMe* drives) ○ 8 x 2.5" SAS/SATA/NVMe* hot swap drive bays ○ 16 x 2.5" SAS/SATA/NVMe* hot swap drive bays ○ 24 x 2.5" SAS/SATA/NVMe* swap drive bays ○ 2 x 2.5" SATA SSD back of chassis hot-swap drive bays (accessory option) ○ 2 x internal fixed mount 2.5" SSDs (all system models)
Supported Rack Mount Kit Accessory Options	<ul style="list-style-type: none"> • AXXELVRAIL – Enhanced value rack mount rail kit – 424 mm max travel length, 59 kg max supported weight • AXXFULLRAIL – 2U premium rail with CMA support – 800 mm max travel length, 45 kg max supported weight • AXXSHRTRAIL – 2U premium rail without CMA support – 788 mm max travel length, 45 kg max supported weight • AXX2POSTBRCKT – Two post fixed mount bracket kit • AXXCMA2– Cable management arm (supported with AXXFULLRAIL only)

1.7 Intel® Server System R2000WFTF Product Family

This section gives an overview of the available systems in the Intel® Server System R2000WFTF product family. The “xxx” notation defines the specific product model or code. For complete configuration details, see Section 3.2.

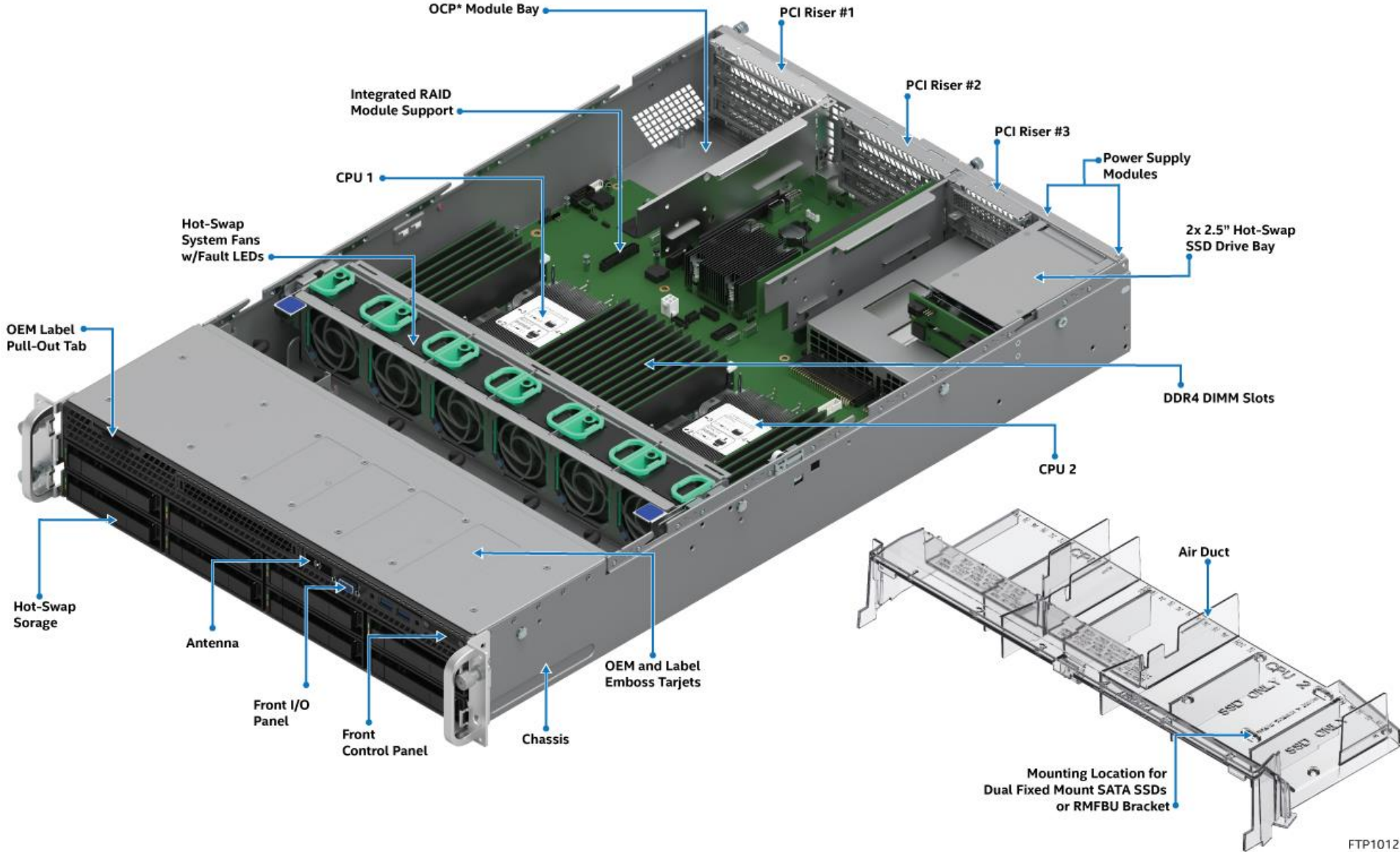


Figure 17. Intel® Server System R2000WFTF feature set identification



Figure 18. 2U, 2.5" x 8 drive configuration (Intel® Server System LFRB2208WFTFxxx)



Figure 19. 2U, 3.5" x 12 drive configuration (Intel® Server System LFRB2312WFTFxxx – storage configuration)



Figure 20. System back panel for Intel® Server System R2000WFTF with optional 2 x 2.5" hot-swap drive bay

Table 9. Intel® Server System R2000WFTF product family features table

Feature	Description
Chassis Type	2U rack mount chassis
Server Board	Intel® Server Board S2600WFTF product family
Maximum Supported Processor Thermal Design Power (TDP)	Up to 150 W
External I/O Connections	<ul style="list-style-type: none"> • DB-15 video connectors <ul style="list-style-type: none"> ○ Front and back (non-storage system configurations only) • RJ-45 serial port A connector • Dual RJ-45 network interface connectors (S2600WFTF-based systems only) • Dedicated RJ-45 server management NIC • (3) – USB 3.0 connectors on back panel • (2) – USB 3.0 connectors on front panel (non-storage system configurations only) • (1) – USB 2.0 connector on rack handle (storage configurations only)
Internal I/O Connectors/Headers	<ul style="list-style-type: none"> • (1) – Type-A USB 2.0 connector • (1) – DH-10 serial port B connector
System Fans	<ul style="list-style-type: none"> • (6) – managed 60 mm hot swap capable system fans • Integrated fans included with each installed power supply module
Riser Card Support	<p>Support for three riser cards:</p> <ul style="list-style-type: none"> • Riser #1 – PCIe* 3.0 x24 – up to 3 PCIe* slots • Riser #2 – PCIe* 3.0 x24 – up to 3 PCIe* slots • Riser #3 – PCIe* 3.0 x16 – up to 2 PCIe* slots – Low profile cards only (optional) <p>With three riser cards installed, up to eight possible add-in cards can be supported:</p> <ul style="list-style-type: none"> • (4) full height/full-length + (2) full height/half-length add-in cards via Risers #1 and #2 • (2) low profile add-in cards via riser #3 (option)
Power Supply Options	<p>The server system can have up to two power supply modules installed, supporting the following power configurations: 1+0, 1+1 redundant power, and 2+0 combined power.</p> <p>(1) power supply option:</p> <ul style="list-style-type: none"> • AC 1300 W Titanium
Remote Management	Intel® Remote Management Module 4 (Intel® RMM4) Lite activation key
Drive Bay Options	<ul style="list-style-type: none"> • Hot-swap backplane options: <ul style="list-style-type: none"> ○ 8 x 2.5" combo backplane – SAS/SATA/NVMe* ○ 12 x 3.5" SAS/ SATA (supports up to 2 NVMe* drives) <p>Note: All available backplane options have support for SAS 3.0 (12 Gb/sec).</p> <ul style="list-style-type: none"> • Storage bay options: <ul style="list-style-type: none"> ○ 12 x 3.5" SAS/SATA hot-swap drive bays (supports up to 2 NVMe* drives) + storage front panel ○ 8 x 2.5" SAS/SATA/NVMe* hot-swap drive bays + PFR front panel ○ 16 (8+8 accessory) x 2.5" SAS/SATA/NVMe* hot-swap drive bays + PFR front panel ○ 2 x 2.5" SATA SSD back of chassis hot-swap drive bays (accessory option) ○ 2 x internal fixed mount 2.5" SSDs (all system models)

Intel® Server S2600WF Product Family Configuration Guide

Feature	Description
Supported Rack Mount Kit Accessory Options	<ul style="list-style-type: none"> • AXSELVRAIL – Enhanced value rack mount rail kit – 424 mm max travel length, 59 kg max supported weight • AXXFULLRAIL – 2U premium rail with CMA support – 800 mm max travel length, 45 kg max supported weight • AXXSHRTRAIL – 2U premium rail without CMA support – 788 mm max travel length, 45 kg max supported weight • AXX2POSTBRCKT – Two post fixed mount bracket kit • AXXCMA2– Cable management arm (supported with AXXFULLRAIL only)

1.8 Available Server Board, Chassis, and System SKU Summary

The following tables provide an overview of available Intel product codes for building blocks and systems within the Intel® S2600WF product family. Each line item identifies key features supported in the shipping Intel SKU. Additional order code information and full product descriptions for each option are provided in later sections.

The following terms are used in the tables:

- **N/A:** Not applicable.
- **Opt:** Accessory option sold separately.
- **Yes:** Option included.
- **KDK:** Knock Down Kit – Intel term for a chassis only product (L3).
- **BIK:** Server board in KDK – Intel term for integrated (L6 and L9) system product.
- **L3:** Server System Building Block – Chassis components only (KDK). No server board installed.
- **L6:** Integrated system – Chassis and server board, with no processors, memory, or storage devices.
- **L9:** Integrated system – Chassis and server board, with processors and memory, no storage devices, some accessory options included. See server system configurations in Chapter 3 for product code specific details. The L9 systems listed are part of the Intel® Data Center Blocks with Firmware Resilience product.

Table 10. Server board product family summary

Intel Product Code (iPC)	# of CPU sockets	# of DIMM Slots	# of Riser Slots	Onboard 10GbE LAN ports	Onboard SATA ports (6 Gb)	Onboard NVMe* Ports	Intel® SAS RAID Module support	Intel® Ethernet Network Adapter for OCP* Support	Onboard Video	Intel® QAT Support	Onboard System Fan Support
S2600WF0(R)	2	24	3	0	12	4	Yes	Yes	Yes	No	Up to 6
S2600WFT(R)	2	24	3	2	12	4	Yes	Yes	Yes	No	Up to 6
S2600WFQ(R)	2	24	3	0	4	2	Yes	Yes	Yes	Yes	Up to 6

Table 11. Server chassis (KDK) product family summary

Intel Product Code (iPC)	Integration Level	Chassis Form Factor	Server Board Option	Drive Form Factor	# of Drives (front)	2.5" NVMe* Support	# of SSDs Drives (rear)	# of PCIe* Add-in Card Slots	3rd Riser	Power Supply Modules	Rails	SAS RAID	SAS Expander
R1304WFXXX	L3	1U	Opt	3.5"/2.5"	4	No	N/A	Opt (up to 2)	N/A	Opt	Opt	Opt	N/A
R1208WFXXX	L3	1U	Opt	2.5"	8	Yes	N/A	Opt (up to 2)	N/A	Opt	Opt	Opt	N/A
R2000WFXXX	L3	2U	Opt	Opt	Opt	Opt	Opt	Opt (up to 8)	Opt	Opt	Opt	Opt	Opt
R2312WFXXX	L3	2U	Opt	3.5"/2.5"	12	Opt	Opt	Opt (up to 8)	Opt	Opt	Opt	Opt	Opt

Note: The Intel® Server Chassis R2000WF can support all available 8x2.5" drive bay accessory options.

Table 12. Server system (BIK) product family summary

Intel Product Code (iPC)	Chassis Form Factor	Server Board Option	Drive Form Factor	# of Drives (front) ¹	2.5" NVMe* Support	# of SSD Drives (rear)	# of PCIe* Add-in Card Slots	3rd Riser	Power Supply Modules	Rails	SAS RAID	SAS Expander	Memory Included	Processor Included
L6 Systems														
R1304WFTYS(R)	1U	S2600WFT(R)	3.5"/2.5"	4	No	N/A	2	N/A	1x 1100W AC	Opt	Opt	N/A	No	No
R1304WFOYS(R)	1U	S2600WFO(R)	3.5"/2.5"	4	No	N/A	2	N/A	1x 1100W AC	Opt	Opt	N/A	No	No
R1208WFTYS(R)	1U	S2600WFT(R)	2.5"	8	Up to 8	N/A	2	N/A	1x 1100W AC	Opt	Opt	N/A	No	No
R1208WFQYSR	1U	S2600WFQ(R)	2.5"	8	Up to 8	N/A	2	N/A	1x 1100W AC	Opt	Opt	N/A	No	No
R2308WFTZS(R)	2U	S2600WFT(R)	3.5"/2.5"	8	No	Opt	8	Yes	1x 1300W AC	Opt	Opt	N/A	No	No
R2312WF0NP(R)	2U	S2600WFO(R)	3.5"/2.5"	12	Up to 2	Opt	8	Yes	Opt	Opt	Opt	Opt	No	No
R2312WFTZS(R)	2U	S2600WFT(R)	3.5"/2.5"	12	Up to 2	Opt	8	Yes	1x 1300W AC	Opt	Opt	Opt	No	No
R2312WFQZS	2U	S2600WFTQ	3.5"/2.5"	12	No	Opt	8	Yes	1x 1300W AC	Opt	Opt	Opt	No	No
R2208WFTZS(R)	2U	S2600WFT(R)	2.5"	8	Up to 8	Opt	8	Yes	1x 1300W AC	Opt	Opt	Opt	No	No
R2208WFOZS(R)	2U	S2600WFO(R)	2.5"	8	Up to 8	Opt	8	Yes	1x 1300W AC	Opt	Opt	Opt	No	No
R2208WFQZS(R)	2U	S2600WFQ(R)	2.5"	8	Up to 8	Opt	8	Yes	1x 1300W AC	Opt	Opt	Opt	No	No
R2224WFTZS(R)	2U	S2600WFT(R)	2.5"	24	Up to 24	Opt	8	Yes	1x 1300W AC	Opt	Opt	Opt	No	No
R2224WFQZS	2U	S2600WFQ	2.5"	24	Up to 24	Opt	8	Yes	1x 1300W AC	Opt	Opt	Opt	No	No
L9 Systems														
LFRB2208WFTF801	2U	S2600WFTF	2.5"	8	Up to 8	Opt	8	Yes	2x 1300W	Opt	Opt	Opt	Yes	Yes
LFRB2208WFTF601	2U	S2600WFTF	2.5"	8	Up to 8	Opt	8	Yes	2x 1300W	Opt	Opt	Opt	Yes	Yes
LFRB2208WFTF401	2U	S2600WFTF	2.5"	8	Up to 8	Opt	8	Yes	2x 1300W	Opt	Opt	Opt	Yes	Yes
LFRB2312WFTF801	2U	S2600WFTF	3.5"/2.5"	12	Up to 2	Opt	8	Yes	2x 1300W	Opt	Opt	Opt	Yes	Yes
LFRB2312WFTF601	2U	S2600WFTF	3.5"/2.5"	12	Up to 2	Opt	8	Yes	2x 1300W	Opt	Opt	Opt	Yes	Yes
LFRB2312WFTF401	2U	S2600WFTF	3.5"/2.5"	12	Up to 2	Opt	8	Yes	2x 1300W	Opt	Opt	Opt	Yes	Yes

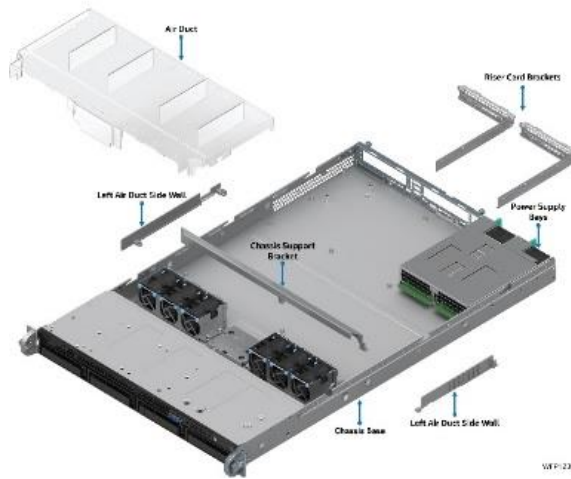
¹ All front drive bays are 12Gb SAS capable.

Note: Intel Product Codes (iPC) without (R) are not longer available to order, refer to replacement part if available.

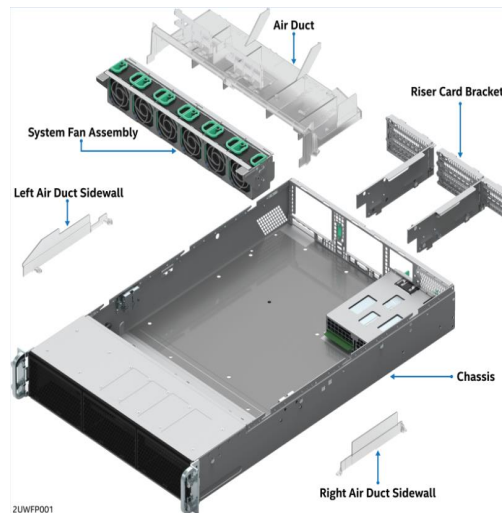
2. Server Building Block Options

Server building blocks are offered to provide the option of choosing from available Intel® server components to create a custom system configuration from the chassis up. Each building block component and optional accessory is purchased separately and assembled by a system integrator. At a minimum, a base functional server system using building blocks requires the following:

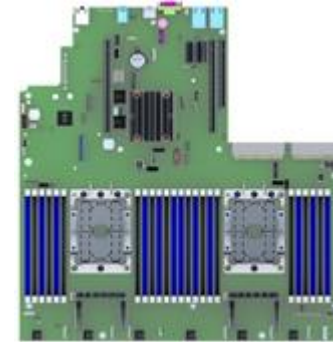
- 1U or 2U Intel® Server Chassis
- Intel® Server Board S2600WF product family option
- Power supply module(s)
- SATA/NVMe* data cables
- Power cord(s)
- Rack mount kit – rails or fixed mount
- Processor
- Memory
- Storage devices



Intel® Server Chassis R1000WF



Intel® Server Chassis R2000WF



Intel® Server Board S2600WF



Power supply modules



PCIe* riser cards

Figure 21. Illustration of building block options

Note: Preconfigured L9 systems are also offered and require only the addition of power cords and storage devices to become a functional server. L9 systems are a part of the Intel® Data Center Block with Firmware Resilience product.

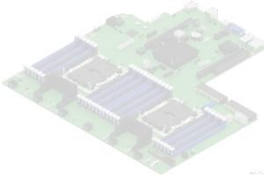
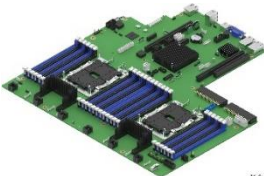
Optional Intel accessories that can be added include the following:

- Riser cards options
- Intel® SAS/SAS RAID support – PCIe* add-in card or module and appropriate SAS data cable(s)
- Intel® Ethernet Network Adapter for OCP* – to add additional features without losing a PCIe* add-in slot
- Intel® Remote Management Module Lite key – to add advanced server management features

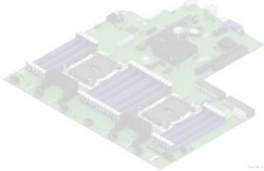
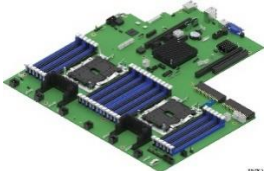
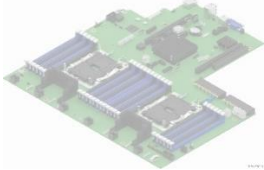
See Chapter 5 for all available options.

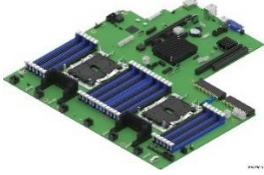
2.1 Intel® Server Board S2600WF Product Family Options

Table 13. Intel® Server Board S2600WF product family options

Product Image	Details	Description
	<p>Intel® Server Board S2600WFT This part is no longer available to order, refer to replacement part MM# 986004. See PCN116894-02 for more details.</p> <p>iPC S2600WFT MM# 952641 UPC 00735858344463 EAN 5032037105255 MOQ 1</p> <p>Product type Server board only Building block/spare FRU</p> <p>Packaged gross wt. 3.3 kg (7.3 lb) Un-packaged net wt. 1.7 kg (4.2 lb)</p>	<p>See Table 5 for the complete feature set. Unique board features include:</p> <ul style="list-style-type: none"> • Intel® C624 chipset • Onboard dual-port RJ45 10 GbE LAN • (4) – onboard PCIe* NVMe* OCuLink connectors • (12) – SATA 6 Gbps ports <p>Box includes: (1) server board</p> <p>Note: All necessary mounting hardware, cabling, and shielding ship with the chassis and optional accessory kits.</p>
	<p>Intel® Server Board S2600WFTR</p> <p>iPC S2600WFTR MM# 986004 UPC 00735858406772 EAN 5032037151030 MOQ 1</p> <p>Product type Server board only Building block/spare FRU</p> <p>Packaged gross wt. 3.3 kg (7.3 lb) Un-packaged net wt. 1.7 kg (4.2 lb)</p>	<p>See Table 5 for the complete feature set. Unique board features include:</p> <ul style="list-style-type: none"> • Intel® C624 chipset • Onboard dual-port RJ45 10 GbE LAN • (4) – onboard PCIe* NVMe* OCuLink connectors • (12) – SATA 6 Gbps ports • Support for Intel® Optane™ DC persistent memory module <p>Box includes: (1) server board</p> <p>Note: All necessary mounting hardware, cabling, and shielding ship with the chassis and optional accessory kits.</p>

Intel® Server S2600WF Product Family Configuration Guide

Product Image	Details	Description
	<p>Intel® Server Board S2600WF0 This part is no longer available to order, refer to replacement part MM# 986005. See PCN116894-02 for more details.</p> <p>iPC S2600WF0 MM# 952644 UPC 00735858344470 EAN 5032037105262 MOQ 1</p> <p>Product type Server board only Building block/spare FRU</p> <p>Packaged gross wt. 3.3 kg (7.3 lb) Un-packaged net wt. 1.7 kg (4.2 lb)</p>	<p>See Table 5 for the complete feature set. Unique board features include:</p> <ul style="list-style-type: none"> • Intel® C624 chipset • No onboard LAN • (4) – onboard PCIe* NVMe* OCuLinkconnectors • (12) – SATA 6 Gbps ports <p>Box includes: (1) server board</p> <p>Note: All necessary mounting hardware, cabling, and shielding ship with the chassis and optional accessory kits.</p>
	<p>Intel® Server Board S2600WFOR</p> <p>iPC S2600WFOR MM# 986005 UPC 00735858406796 EAN 5032037151054 MOQ 1</p> <p>Product type Server board only Building block/spare FRU</p> <p>Packaged gross wt. 3.3 kg (7.3 lb) Un-packaged net wt. 1.7 kg (4.2 lb)</p>	<p>See Table 5 for the complete feature set. Unique board features include:</p> <ul style="list-style-type: none"> • Intel® C624 chipset • No onboard LAN • (4) – onboard PCIe* NVMe* OCuLinkconnectors • (12) – SATA 6 Gbps ports • Support for Intel® Optane™ DC persistent memory module <p>Box includes: (1) server board</p> <p>Note: All necessary mounting hardware, cabling, and shielding ship with the chassis and optional accessory kits.</p>
	<p>Intel® Server Board S2600WFQ This part is no longer available to order, refer to replacement part MM# 986006. See PCN116894-02 for more details.</p> <p>iPC S2600WFQ MM# 952645 UPC 00735858344456 EAN 5032037105248 MOQ 1</p> <p>Product type Server board only Building block/spare FRU</p> <p>Packaged gross wt. 3.3 kg (7.3 lb) Un-packaged net wt. 1.7 kg (4.2 lb)</p>	<p>See Table 5 for the complete feature set. Unique board features include:</p> <ul style="list-style-type: none"> • Intel® C628 chipset • Support for Intel® QuickAssist Technology (Intel® QAT) • No onboard LAN • (2) – onboard PCIe* NVMe* OCuLinkconnectors • (4) – SATA 6 Gbps ports <p>Box includes: (1) server board and (1) Intel® QAT cable</p> <p>Note: All necessary mounting hardware, cabling, and shielding ship with the chassis and optional accessory kits. OCuLink connectors from CPU1 can be used for NVMe* drives. OCuLink connectors from CPU2 are used for the Intel® QAT link and do not work for NVMe* drives.</p>

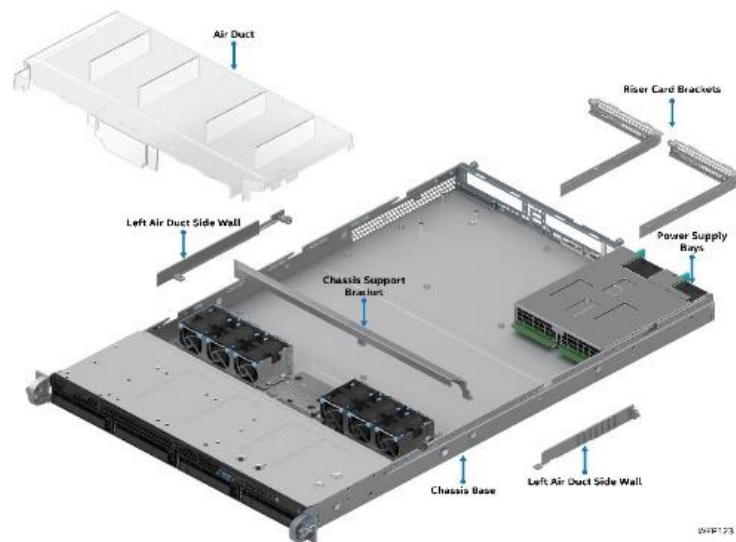
Product Image	Details	Description
	<p>Intel® Server Board S2600WFQR</p> <p>iPC S2600WFQR MM# 986006 UPC 00735858406819 EAN 5032037151078 MOQ 1</p> <p>Product type Server board only Building block/spare FRU</p> <p>Packaged gross wt. 3.3 kg (7.3 lb) Un-packaged net wt. 1.7 kg (4.2 lb)</p>	<p>See Table 5 for the complete feature set. Unique board features include:</p> <ul style="list-style-type: none"> • Intel® C628 chipset • Support for Intel® QuickAssist Technology (Intel® QAT) • No onboard LAN • (2) – onboard PCIe* NVMe* OCuLinkconnectors • (4) – SATA 6 Gbps ports • Support for Intel® Optane™ DC persistent memory module <p>Box includes: (1) server board and (1) Intel® QAT cable</p> <p>Note: All necessary mounting hardware, cabling, and shielding ship with the chassis and optional accessory kits. OCuLink connectors from CPU1 can be used for NVMe* drives. OCuLink connectors from CPU2 are used for the Intel® QAT link and do not work for NVMe* drives.</p>

2.2 Intel® Server Chassis Product Family Options

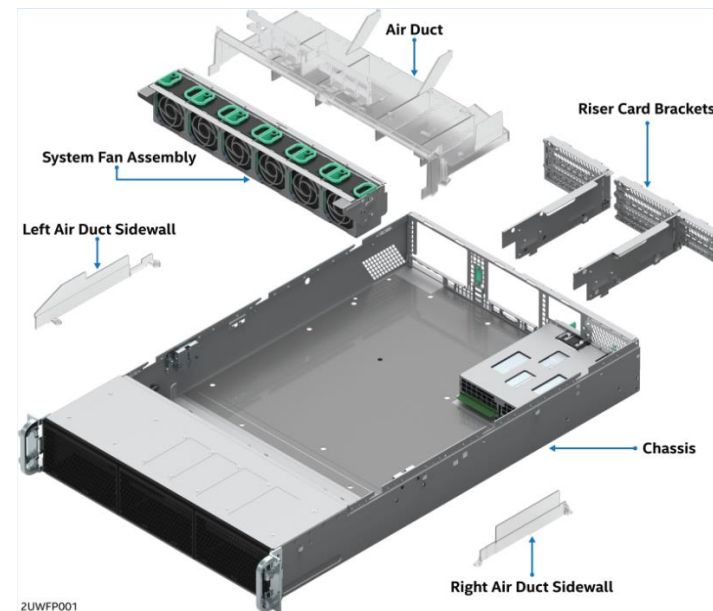
The product tables found in this section provide order code information and detailed descriptions for each available 1U and 2U Intel® server chassis building block option. The lower sections of each table identify:

- **Included** – The ship along components of the specified chassis product code (product BOM).
- **Required items** – Hardware required to be installed to the base system to achieve basic functionality using the default system feature set. Required items are sold separately.
- **Optional accessories** – Some of the available accessories that can be installed to enhance the basic feature set of the server board/chassis. Optional accessories are sold separately. Additional accessories can be found in Chapter 5.

Note: Items identified with an iPC (Intel Product Code) are orderable building block options, accessories, or spare FRUs. In an effort to provide the complete product bill of materials, the ship along components list in each product table include items identified by description and by iPN (Intel Part Number). The iPN information is provided for reference only. These components are not orderable as spares or accessories.



Intel® Server Chassis R1000WF



Intel® Server Chassis R2000WF

Figure 22. Intel® Server Chassis options

Table 14. Intel® Server Chassis R1304WFXML product specifications and configuration requirements


Intel® Server Chassis R1304WFXML 1U, 4 x 3.5" HDD or 4 x 2.5" SSD SATA/SSD front mount drives																									
	<table border="0"> <tr><td>iPC</td><td>R1304WFXML</td></tr> <tr><td>MM#</td><td>99AWZA</td></tr> <tr><td>UPC</td><td>00735858344722</td></tr> <tr><td>EAN</td><td>5032037105439</td></tr> <tr><td>MOQ</td><td>1</td></tr> </table>	iPC	R1304WFXML	MM#	99AWZA	UPC	00735858344722	EAN	5032037105439	MOQ	1	<table border="0"> <tr><td>Product type</td><td>Chassis only</td></tr> <tr><td>Chassis form factor</td><td>1U rack mount</td></tr> <tr><td>Packaged gross wt.</td><td>19 kg (41.9 lb)</td></tr> <tr><td>Un-packaged net wt.</td><td>10.3 kg (22.7 lb)</td></tr> <tr><td>Chassis dimensions</td><td>712 x 439 x 43.2 mm (L x W x H)</td></tr> <tr><td>Package dimensions</td><td>983 x 577 x 260 mm (L x W x H)</td></tr> </table>	Product type	Chassis only	Chassis form factor	1U rack mount	Packaged gross wt.	19 kg (41.9 lb)	Un-packaged net wt.	10.3 kg (22.7 lb)	Chassis dimensions	712 x 439 x 43.2 mm (L x W x H)	Package dimensions	983 x 577 x 260 mm (L x W x H)	
iPC	R1304WFXML																								
MM#	99AWZA																								
UPC	00735858344722																								
EAN	5032037105439																								
MOQ	1																								
Product type	Chassis only																								
Chassis form factor	1U rack mount																								
Packaged gross wt.	19 kg (41.9 lb)																								
Un-packaged net wt.	10.3 kg (22.7 lb)																								
Chassis dimensions	712 x 439 x 43.2 mm (L x W x H)																								
Package dimensions	983 x 577 x 260 mm (L x W x H)																								
Included	Required Items (sold separately)	Optional Accessories (sold separately)																							
<p>(1) – 1U chassis with Quick Reference Label affixed to top cover (4) – 3.5" hot-swap drive bays with drive carriers and drive blanks. Includes:</p> <ul style="list-style-type: none"> • (1) 12 Gb SAS backplane – iPC FR1304S3HSBP • (4) 3.5" hot swap drive tool less carriers – iPC FXX35HSCAR2 <p>(1) – Preinstalled standard control panel assembly (board only – iPC FXXFPANEL2)</p> <ul style="list-style-type: none"> • 260 mm front panel cable – iPN J25698-xxx <p>(1) – Preinstalled front I/O panel assembly (1 x VGA and 2 x USB)</p> <ul style="list-style-type: none"> • 620 mm USB 3.0 cable – iPN H76899-xxx • 400 mm video cable – iPN H62114-xxx <p>(1) – Server board to backplane 150mm I2C cable – iPN H91171-xxx (1) – 850mm mini SAS HD cable – iPC AXXCBL850HDHRT (1) – 350mm backplane power cable – iPN H82100-xxx (1) – Air duct – iPN H90054-xxx (6) – Dual rotor system fans – iPC FR1UFAN10PW (2) – CPU heat sinks, 39 fin passive – iPN J39509-xxx (2) – CPU heat sink "No CPU" label inserts – iPN J16115-xxx (2) – Standard CPU carriers – iPN H72851-xxx (2) – 1 slot PCIe* x16 Riser Card – iPN H88399-xxx (8) – DIMM slot blanks – iPN G75158-xxx (1) – Chassis Stiffener Bar – iPN J16623-xxx (1) – Power supply bay blank insert (2) – AC power cord retention strap assembly – iPN H23961-00x Server board and riser card mounting screws Spares for each screw type included</p>	<ul style="list-style-type: none"> • Intel® Server Board S2600WF (choose one) <ul style="list-style-type: none"> ○ iPC S2600WFT(R) ○ iPC S2600WF0(R) ○ iPC S2600WFQ(R) • Power supply module(s) (choose one type) – (2) common modules required for redundancy <ul style="list-style-type: none"> ○ 1300W AC power supply module – iPC AXX1300TCRPS ○ 1100W AC power supply module – iPC AXX1100PCRPS ○ 750 W DC power supply module – iPC AXX750DCCRPS • Power cord(s) – See Section 5.6 • Rack mount kit – See Section 5.7 • (1) or (2) 1st or 2nd Gen Intel® Xeon® processor Scalable family – see Section 1.1.1 for details on processor support • ECC DDR4 memory (RDIMM or LRDIMM) 	<ul style="list-style-type: none"> • Intel® Ethernet Network Adapter for OCP* – See Section 5.4 for available options • Intel® RAID Card/Module – See Section 5.5 for options • SAS/SATA data cables – Cable selection is dependent on desired storage option. See Chapter 4 for available cable options • Intel® Remote Management Module 4 Lite for advanced management features – iPC AXXRMM4LITE • Storage drives • DDDC DDR-compatible Intel® Optane™ DC persistent memory module (supported by Intel® Server Boards S2600WFT(R), S2600WF0(R), and S2600WFQ(R) with a 2nd Gen Intel® Xeon® Scalable processor) <p>See Chapters 5 and 6 for all available accessory options.</p>																							

Table 15. Intel® Server Chassis R1208WFXML product specifications and configuration requirements


Intel® Server Chassis R1208WFXML				
1U, 8 x 2.5" HDD or 4 x 2.5" SSD SATA/SSD/NVMe* front mount drives				
	iPC	R1208WFXML	Product type	Chassis only
	MM#	952621	Chassis form factor	1U rack mount
	UPC	00735858390316	Packaged gross wt.	18.5 kg (40.9 lb)
	EAN	5032037138574	Un-packaged net wt.	10.3 kg (22.7 lb)
	MOQ	1	Chassis dimensions	712 x 439 x 43.2 mm (L x W x H)
			Package dimensions	983 x 577 x 260 mm (L x W x H)
Included	Required Items (sold separately)		Optional Accessories (sold separately)	
<p>(1) – 1U chassis with Quick Reference Label affixed to top cover</p> <p>(8) – 2.5" hot-swap drive bays with drive carriers and drive blanks. Includes:</p> <ul style="list-style-type: none"> • (1) SAS/NVMe* Combo backplane – iPC F1U8X25S3PHS • (8) 2.5" hot swap drive tool less carriers – iPC FXX25HSCAR3 <p>(1) – Preinstalled standard control panel assembly (board only – iPC FXXFPANEL2)</p> <ul style="list-style-type: none"> • 260 mm front panel cable – iPN J25698-xxx <p>(1) – Preinstalled front I/O panel assembly (1x VGA and 2x USB)</p> <ul style="list-style-type: none"> • 620 mm USB 3.0 cable – iPN H76899-xxx • 400 mm video cable – iPN H62114-xxx <p>(1) – 200mm backplane I2C cable – iPN H91170-xxx</p> <p>(1) – 650mm mini SAS HD Cable – iPC AXXCBL650HDHRT</p> <p>(1) – 850mm mini SAS HD cable – iPC AXXCBL850HDHRT</p> <p>(1) – 400mm backplane power cable – iPN H82099-xxx</p> <p>(1) – Air duct – iPN H90054-xxx</p> <p>(6) – Dual rotor system fans – iPC FR1UFAN10PW</p> <p>(2) – CPU heat sinks, 39 fin passive – iPN J39509-xxx</p> <p>(2) – CPU heat sink "No CPU" label inserts – iPN J16115-xxx</p> <p>(2) – Standard CPU carriers – iPN H72851-xxx</p> <p>(2) – 1 slot PCIe* x16 Riser Card – iPN H88399-xxx</p> <p>(8) – DIMM slot blanks – iPN G75158-xxx</p> <p>(1) – Chassis Stiffener Bar – iPN J16623-xxx</p> <p>(1) – Power supply bay blank insert</p> <p>(2) – AC power cord retention strap assembly – iPN H23961-00x</p> <p>Server board and riser card mounting screws</p> <p>Spares for each screw type included</p>	<ul style="list-style-type: none"> • Intel® Server Board S2600WF (choose one) <ul style="list-style-type: none"> ○ iPC S2600WFT(R) ○ iPC S2600WF0(R) ○ iPC S2600WFQ(R) • Power supply module(s) (choose one type) – (2) common modules required for redundancy <ul style="list-style-type: none"> ○ 1300W AC power supply module – iPC AXX1300TCRPS ○ 1100W AC power supply module – iPC AXX1100PCRPS ○ 750 W DC power supply module – iPC AXX750DCCRPS • Power cord(s) – See Section 5.6 • Rack mount kit – See Section 5.7 • (1) or (2) 1st or 2nd Gen Intel® Xeon® processor Scalable family – see Section 1.1.1 for details on processor support • ECC DDR4 memory (RDIMM or LRDIMM) 		<ul style="list-style-type: none"> • Intel® Ethernet Network Adapter for OCP* – See Section 5.4 for available options • Intel® RAID Card/Module – See Section 5.5 for options • SAS/SATA data cables – Cable selection is dependent on desired storage option. See Chapter 4 for available cable options • Intel® Remote Management Module 4 Lite for advanced management features – iPC AXXRMM4LITE • Storage drives • DDDC DDR-compatible Intel® Optane™ DC persistent memory module (supported by Intel® Server Boards S2600WFT(R), S2600WF0(R), and S2600WFQ(R) with a 2nd Gen Intel® Xeon® Scalable processor) <p>See Chapters 5 and 6 for all available accessory options.</p>	

Table 16. Intel® Server Chassis R2000WFXML product specifications and configuration requirements

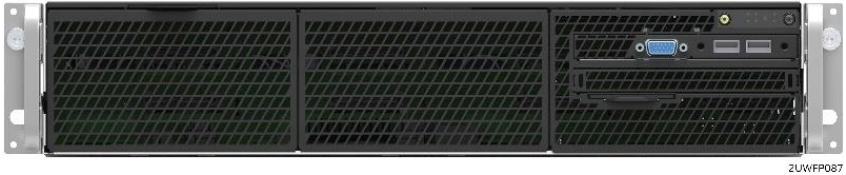

Intel® Server Chassis R2000WFXML 2U, no front mount drives				iPC MM# UPC EAN MOQ	R2000WFXML 975897 00735858344746 5032037105453 1	Product type Chassis form factor Packaged gross wt. Un-packaged net wt. Chassis dimensions Package dimensions	Chassis only 2U rack mount 19 kg (41.9 lb) 13.3 kg (29.3 lb) 712 x 439 x 89 mm (L x W x H) 983 x 577 x 260 mm (L x W x H)
Included		Required Items (sold separately)		Optional Accessories (sold separately)			
(1) – 2U Chassis with Quick Reference Label affixed to top cover (1) – Preinstalled standard control panel assembly (board only – iPC FXXPANEL2) o 300 mm front panel cable – iPN H34381-xxx (1) – Preinstalled front I/O panel assembly (1x VGA and 2x USB 3.0) o 620 mm USB 3.0 cable – iPN H76899-xxx o 400 mm video cable – iPN H62114-xxx (1) – Standard 2U air duct iPN H90554-xxx (6) – 60 mm hot swap system fan – iPC FR2UFAN60HSW (2) – CPU heat sink – iPC H38569-xxx (2) – CPU heat sink “No CPU” label insert – iPN J16115-xx (2) – Standard CPU carrier – iPN H72851-xxx (1) – 3x Intel® RAID Maintenance Free Backup unit mounting bracket – iPN H18238-00x (16) – DIMM slot blank – iPN G75158-xxx (1) – 175 mm I2C cable – iPN H91172-xxx (1) – 250 mm I2C cable – iPN H91166-xxx (1) – 400/525/675 mm HSBP power cable – iPN H82108-xxx (1) – Internal fixed mount 250 mm SSD drive power cable – iPN J29245-xxx (2) – Riser card mounting brackets supporting up to 3 riser cards (riser cards sold separately – see Section 5.2) (1) – Power supply bay blank insert (2) – AC power cord retention strap assembly – iPN H23961-00x Server board and riser card mounting screws Spares for each screw type included		<ul style="list-style-type: none"> • Intel® Server Board S2600WF (choose one) <ul style="list-style-type: none"> o iPC S2600WFT(R) o iPC S2600WF0(R) o iPC S2600WFQ(R) • Power supply module(s) (choose one type) – (2) common modules required for redundancy <ul style="list-style-type: none"> o 1300W AC power supply module – iPC AXX1300TCRPS o 1100W AC power supply module – iPC AXX1100PCRPS o 750 W DC power supply module – iPC AXX750DCCRPS • Power cord(s) – See Section 5.6 • Rack mount kit – See Section 5.7 • (1) or (2) 1st or 2nd Gen Intel® Xeon® processor Scalable family – see Section 1.1.1 for details on processor support • ECC DDR4 memory (RDIMM or LRDIMM) 		<p>Front storage bay option</p> <ul style="list-style-type: none"> • Up to (3) 8 x 2.5" drive bay modules: <ul style="list-style-type: none"> o SAS/SATA/NVMe* combo – iPC A2U8X25S3PHS • 8 x 3.5" drive bay module – iPC A2U8X35S3HSDK1 (Reuses control panel and front I/O panel. Includes SAS/SATA data cables and peripheral power cable) <p>Rear storage bay option</p> <ul style="list-style-type: none"> • Up to (2) hot swap SATA SSDs – iPC A2UREARHSDK2 <p>Riser Cards – Up to (3) can be installed concurrently</p> <ul style="list-style-type: none"> • Risers Slots #1 and #2 – Available riser cards include: <ul style="list-style-type: none"> o 3-slot riser card, (3) x8 PCIe* 3.0 slots – iPC A2UL8RISER2 o 2-slot riser card, (1) x16 PCIe* slot and (1) x8 PCIe* slot – iPC A2UL16RISER2 • Riser Slot #3 – Available riser cards include: <ul style="list-style-type: none"> o 2-slot riser card, (1) low profile x8 PCIe* 3.0 slot and (1) low profile x8 PCIe* 2.0 slot – iPC A2UX8X4RISER <p>Other</p> <ul style="list-style-type: none"> • SAS/SATA/NVMe* data cables – Cable selection is dependent on desired storage option. See Chapter 4 for available cable options • Intel® RAID Card/Module – See Section 5.5 for options • SAS Expander Options – See Sections 4.6.2 and 4.7.4 • Intel® Ethernet Network Adapter for OCP* – See Chapter 5.4 for available options • Intel® Remote Management Module 4 Lite RoHS free key for advanced management features – iPC AXXRMM4LITE2 • DDDC DDR-compatible Intel® Optane™ DC persistent memory module (supported by Intel® Server Boards S2600WFTR, S2600WF0R, and S2600WFQR with a 2nd Gen Intel® Xeon® Scalable processor) <p>See Chapters 5 and 6 for all available accessory options.</p>			

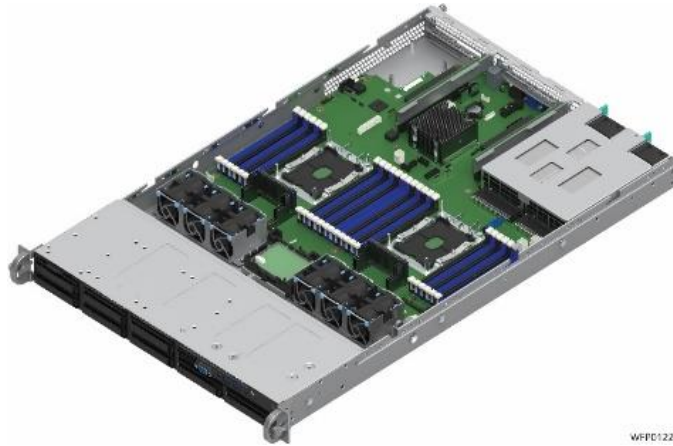
Table 17. Intel® Server Chassis R2312WFXML product specifications and configuration requirements

Intel® Server Chassis R2312WFXML 2U, 2 x 3.5" HDD or 12 x 2.5" SSD SATA/SAS front mount drives (support for up to 2 NVMe* drives)																								
	<table border="0"> <tr> <td>iPC</td> <td>R2312WFXML</td> </tr> <tr> <td>MM#</td> <td>952624</td> </tr> <tr> <td>UPC</td> <td>00735858390309</td> </tr> <tr> <td>EAN</td> <td>5032037138567</td> </tr> <tr> <td>MOQ</td> <td>1</td> </tr> </table>	iPC	R2312WFXML	MM#	952624	UPC	00735858390309	EAN	5032037138567	MOQ	1	<table border="0"> <tr> <td>Product type</td> <td>Chassis only</td> </tr> <tr> <td>Chassis form factor</td> <td>2U rack mount</td> </tr> <tr> <td>Packaged gross wt.</td> <td>19 kg (41.9 lb)</td> </tr> <tr> <td>Un-packaged net wt.</td> <td>13.3 kg (29.3 lb)</td> </tr> <tr> <td>Chassis dimensions</td> <td>712 x 439 x 89 mm (L x W x H)</td> </tr> <tr> <td>Package dimensions</td> <td>983 x 577 x 260 mm (L x W x H)</td> </tr> </table>	Product type	Chassis only	Chassis form factor	2U rack mount	Packaged gross wt.	19 kg (41.9 lb)	Un-packaged net wt.	13.3 kg (29.3 lb)	Chassis dimensions	712 x 439 x 89 mm (L x W x H)	Package dimensions	983 x 577 x 260 mm (L x W x H)
iPC	R2312WFXML																							
MM#	952624																							
UPC	00735858390309																							
EAN	5032037138567																							
MOQ	1																							
Product type	Chassis only																							
Chassis form factor	2U rack mount																							
Packaged gross wt.	19 kg (41.9 lb)																							
Un-packaged net wt.	13.3 kg (29.3 lb)																							
Chassis dimensions	712 x 439 x 89 mm (L x W x H)																							
Package dimensions	983 x 577 x 260 mm (L x W x H)																							
Included	Required Items (sold separately)	Optional Accessories (sold separately)																						
<p>(1) – 2U Chassis with Quick Reference Label affixed to top cover</p> <p>(12) – 3.5" hot-swap drive bays with drive carriers and blanks. Includes:</p> <ul style="list-style-type: none"> o (1) SAS/NVMe* combo backplane – iPC F2U12X35S3PH o (12) 3.5" hot swap drive tool less carriers – iPC FXX35HSCAR2 <p>(1) – Storage Rack Handle Assembly – iPC A2UHANDLKIT</p> <ul style="list-style-type: none"> o 1 set Storage Rack Handles o Mini-front panel (board only – iPN G28538-xxx) o 410 mm front panel cable – iPN H26893-xxx o 640 mm front panel USB 2.0 cable iPN H20005-xxx <p>(1) – 175 mm Backplane I2C Cable – iPN H91172-xxx</p> <p>(1) – 800 mm Mini SAS HD Cable iPC AXXCBL800HDHD</p> <p>(1) – 875 mm Mini SAS HD Cable iPC AXXCBL875HDHD</p> <p>(1) – 525/675 mm Backplane power cable – iPN H82097-xxx</p> <p>(1) – Standard 2U air duct – iPN H90554-xxx</p> <p>(6) – Hot swap system fans – iPC FR2UFAN60HSW</p> <p>(16) – DIMM slot blanks – iPN G75158-00x</p> <p>(1) – Power supply bay blank insert</p> <p>(2) – AC Power Cord retention strap assembly – iPN H23961-00x</p> <p>(2) – CPU heat sinks – iPC FXXCA78X108HS</p> <p>(2) – CPU heat sink “NO CPU” mylar spacer insert – iPN J16115-XXX</p> <p>(2) – Standard CPU carrier – iPN H72851-xxx</p> <p>(1) – 3x Intel® RAID Maintenance Free Backup unit mounting bracket – iPN H18238-00x</p> <p>(1) – 175 mm I2C cable – iPN H91172-xxx</p> <p>(1) – Internal fixed mount 250 mm SSD drive power cable – iPN J29245-xxx</p> <p>(2) – Riser Card mounting brackets supporting up to 3 riser cards (riser cards sold separately – see Section 5.2)</p> <p>(1) – Power supply bay blank insert</p> <p>Server Board and Riser Card mounting screws</p> <p>Spares for each screw type included</p>	<ul style="list-style-type: none"> • Intel® Server Board S2600WF (choose one) <ul style="list-style-type: none"> o iPC S2600WFT(R) o iPC S2600WFO(R) o iPC S2600WFQ(R) • Power supply module(s) (choose one type) – (2) common modules required for redundancy <ul style="list-style-type: none"> o 1300W AC power supply module – iPC AXX1300TCRPS o 1100W AC power supply module – iPC AXX1100PCRPS o 750 W DC power supply module – iPC AXX750DCCRPS • Power cord(s) – See Section 5.6 • Rack mount kit – See Section 5.7 • (1) or (2) 1st or 2nd Gen Intel® Xeon® processor Scalable family – see Section 1.1.1 for details on processor support • ECC DDR4 memory (RDIMM or LRDIMM) 	<p>Rear storage bay option</p> <ul style="list-style-type: none"> • Up to (2) hot swap SATA SSDs – iPC A2UREARHSDK2 <p>Riser Cards – Up to (3) can be installed concurrently</p> <ul style="list-style-type: none"> • Risers Slots #1 and #2 – Available riser cards include: <ul style="list-style-type: none"> o 3-slot riser card, (3) x8 PCIe* 3.0 slots – iPC A2UL8RISER2 o 2-slot riser card, (1) x16 PCIe* slot and (1) x8 PCIe* slot – iPC A2UL16RISER2 • Riser Slot #3 – Available riser cards include: <ul style="list-style-type: none"> o 2-slot riser card, (1) low profile x8 PCIe* 3.0 slot and (1) low profile x8 PCIe* 2.0 slot – iPC A2UX8X4RISER <p>Other</p> <ul style="list-style-type: none"> • SAS/SATA/NVMe* data cables – Cable selection is dependent on desired storage option. See Chapter 4 for available cable options • Intel® RAID Card/Module – See Section 5.5 for options • SAS Expander Options – See Sections 4.6.2 and 4.7.4 • Intel® Ethernet Network Adapter for OCP* – See Chapter 5.4 for available options • Intel® Remote Management Module 4 Lite RoHS free key for advanced management features – iPC AXXRMM4LITE2 • DDDC DDR-compatible Intel® Optane™ DC persistent memory module (supported by Intel® Server Boards S2600WFTR, S2600WFOR, and S2600WFQR with a 2nd Gen Intel® Xeon® Scalable processor) <p>See Chapters 5 and 6 for all available accessory options.</p>																						

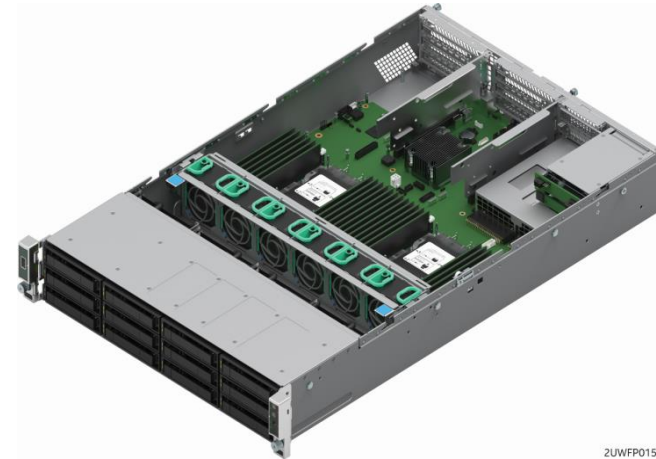
3. Server System Configurations

The Intel® Server S2600WF product family includes several integrated server system options that include a 1U or 2U chassis with different hot swap drive bay configurations, a specific server board, power supply module, and riser cards. At a minimum, building a functional server from one of these options requires the following:

- Rack mount kit – rails or fixed mount
- Power cord(s)
- Processor(s)
- Memory
- Storage drives



Intel® Server System R1000WF product family
(R1208WFxxxx shown)



Intel® Server System R2000WF product family
(R2312WFxxxx shown)

Figure 23. Intel® Server System options

Also offered are preconfigured L9 systems that require only the addition of power cords and storage devices to become a functional server. L9 systems are a part of the Intel® Data Center Block with Firmware Resilience product.

Optional Intel accessories that can be added include:

- Second power supply module to add power redundancy
- Intel® RAID support – PCIe* add-in card or module and appropriate SAS data cable(s)
- Intel® RAID Maintenance Free Backup unit – Intel® RAID backup accessory
- Intel® Ethernet Network Adapter for OCP* – to add additional features without losing a PCIe* add-in slot
- Intel® Remote Management Module Lite key – to add advanced server management features

See Chapters 5 and 6 for a full list of available options.

3.1 Intel® Server System R1000WF Product Family – (1U Rack Mount System)

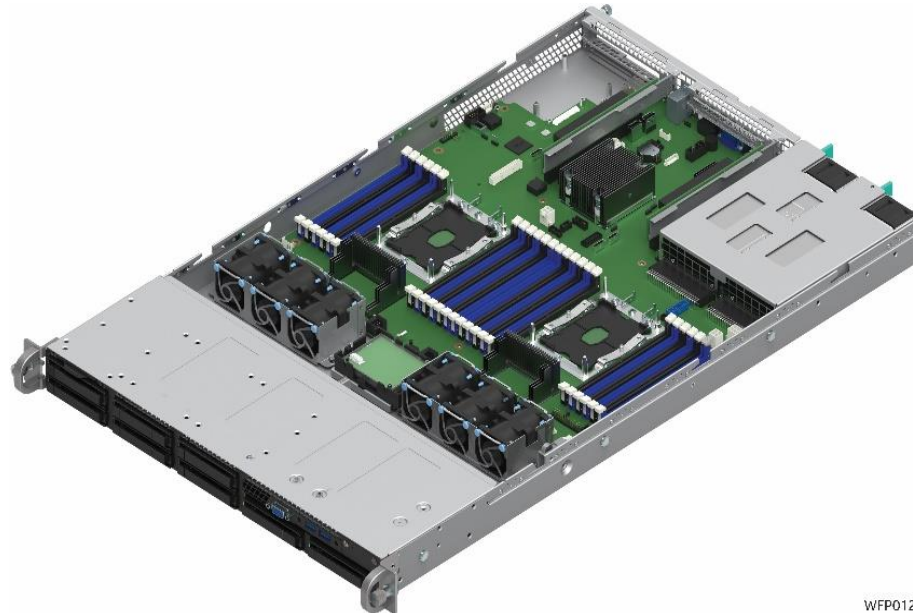
The product tables found in this section provide order code information and detailed descriptions for each available 1U and 2U Intel® server chassis building block option. The lower sections of each table identify:

- **Included** – The ship along components of the specified chassis product code (product BOM).
- **Required items** – Hardware required to be installed to the base system to achieve basic functionality using the default system feature set. Required items are sold separately.
- **Optional accessories** – Some of the available accessories that can be installed to enhance the basic feature set of the server board/chassis. Optional accessories are sold separately. Additional accessories can be found in Chapter 5.

Note: Items identified with an iPC (Intel Product Code) are orderable building block options, accessories, or spare FRUs. In an effort to provide the complete product bill of materials, the ship along components list in each product table include items identified by description and by iPN (Intel Part Number). The iPN information is provided for reference only. These components are not orderable as spares or accessories.

This product family offers two levels of server system integration:

- **L6** – Integrated system: Chassis and server board, with no processors, memory, or storage devices.
- **L9** – Integrated system: Chassis and server board, with processors and memory, no storage devices.



*R1208WFxxxx shown

Figure 24. Intel® Server System R1000WF product family

Table 18. Intel® Server System R1304WFOYS product specifications and configuration requirements


<p>Intel® Server System R1304WFOYS 1U, Intel® Server Board S2600WFO, 4 x 3.5" HDD or 4 x 2.5" SSD SAS/SATA front mount drives</p>		
	<p>This part is no longer available to order, refer to replacement part MM# 986047. See PCN116894-02 for more details.</p>	<p>Product type L6 integrated system Chassis form factor 1U rack mount Packaged gross wt. 20.6 kg (45.3 lb) Un-packaged net wt. 12.3 kg (27.1 lb) Chassis dimensions 712 x 439 x 43.2 mm (L x W x H) Package dimensions 983 x 577 x 260 mm (L x W x H)</p>
	<p>iPC R1304WFOYS MM# 952626 UPC 00735858344715 EAN 5032037105422 MOQ 1</p>	
Included	Required Items (sold separately)	Optional Accessories (sold separately)
<p>(1) – 1U chassis with Quick Reference Label affixed to top cover (1) – Intel® Server Board S2600WFO (no onboard LAN) – iPC S2600WFO (2) – Riser card assembly with 1 slot PCIe* x16 riser card – iPC F1UL16RISER3 (4) – 3.5" hot-swap drive bays with drive carriers and drive blanks. Includes: o (1) 12 Gb SAS backplane – iPC FR1304S3HSBP o (4) 3.5" hot swap drive tool less carriers – iPC FXX35HSCAR2 (1) – Preinstalled standard control panel assembly (board only – iPC FXXFPANEL2) o 260 mm front panel cable – iPN J25698-xxx (1) – Preinstalled front I/O panel assembly (1 x VGA and 2 x USB) o 620 mm USB 3.0 cable – iPN H76899-xxx o 400 mm video cable – iPN H62114-xxx (1) – 150 mm backplane I2C cable – iPN H91171-xxx (1) – 850 mm mini SAS HD cable – iPC AXXCBL850HDHRT (1) – 350 mm backplane power cable – iPN H82100-xxx (1) – Air duct – iPN H90054-xxx (6) – Dual rotor system fans – iPC FR1UFAN10PW (1) – 1100W power supply module – iPC AXX1100PCRPS (2) – CPU heat sinks, 39 fin passive – iPN J39509-xxx (2) – CPU heat sink "No CPU" label inserts – iPN J16115-xxx (2) – Standard CPU Carriers – iPN H72851-xxx (8) – DIMM slot blanks – iPN G75158-xxx (1) – Chassis Stiffener Bar – iPN J16623-xxx (1) – Power supply bay blank insert (2) – AC power cord retention strap assembly – iPN H23961-00x Spares for each screw type included</p>	<ul style="list-style-type: none"> • Power cord(s) – See Section 5.6 • Rack mount kit – See Section 5.7 • (1) or (2) 1st or 2nd Intel® Xeon® processor Scalable family (support for 2nd Gen Intel® Xeon® processor Scalable family requires a system software stack update from http://downloadcenter.intel.com) • ECC DDR4 memory (RDIMM or LRDIMM) 	<p>Note: By default the front drive bays are cabled to onboard SATA only ports. An add-in SAS card or module is needed to support SAS devices.</p> <ul style="list-style-type: none"> • Second 1100W AC power supply module to support power redundancy – iPC AXX1100PCRPS • Intel® Ethernet Network Adapter for OCP* – See Chapter 5.4 for available options • Intel® 12G SAS RAID module and Intel® RAID Maintenance Free Backup unit – See Chapter 5.5 for available options • SAS Data cable – Depending on the location of the SAS Data controller, a new data cable may be necessary. See Chapter 4. • SATA upgrade key for Intel® Embedded Server Technology 2 RAID 5 support – iPC RKSATA4R5 • Storage drives <p>See Chapters 5 and 6 for all available accessory options.</p>

Table 19. Intel® Server System R1304WF0YSR product specifications and configuration requirements


Intel® Server System R1304WF0YSR 1U, Intel® Server Board S2600WF0R, 4 x 3.5" HDD or 4 x 2.5" SSD SAS/SATA front mount drives																									
	<table border="0"> <tr><td>iPC</td><td>R1304WF0YSR</td></tr> <tr><td>MM#</td><td>986047</td></tr> <tr><td>UPC</td><td>00735858406826</td></tr> <tr><td>EAN</td><td>5032037151085</td></tr> <tr><td>MOQ</td><td>1</td></tr> </table>	iPC	R1304WF0YSR	MM#	986047	UPC	00735858406826	EAN	5032037151085	MOQ	1	<table border="0"> <tr><td>Product type</td><td>L6 integrated system</td></tr> <tr><td>Chassis form factor</td><td>1U rack mount</td></tr> <tr><td>Packaged gross wt.</td><td>20.6 kg (45.3 lb)</td></tr> <tr><td>Un-packaged net wt.</td><td>12.3 kg (27.1 lb)</td></tr> <tr><td>Chassis dimensions</td><td>712 x 439 x 43.2 mm (L x W x H)</td></tr> <tr><td>Package dimensions</td><td>983 x 577 x 260 mm (L x W x H)</td></tr> </table>	Product type	L6 integrated system	Chassis form factor	1U rack mount	Packaged gross wt.	20.6 kg (45.3 lb)	Un-packaged net wt.	12.3 kg (27.1 lb)	Chassis dimensions	712 x 439 x 43.2 mm (L x W x H)	Package dimensions	983 x 577 x 260 mm (L x W x H)	
iPC	R1304WF0YSR																								
MM#	986047																								
UPC	00735858406826																								
EAN	5032037151085																								
MOQ	1																								
Product type	L6 integrated system																								
Chassis form factor	1U rack mount																								
Packaged gross wt.	20.6 kg (45.3 lb)																								
Un-packaged net wt.	12.3 kg (27.1 lb)																								
Chassis dimensions	712 x 439 x 43.2 mm (L x W x H)																								
Package dimensions	983 x 577 x 260 mm (L x W x H)																								
Included	Required Items (sold separately)	Optional Accessories (sold separately)																							
<p>(1) – 1U chassis with Quick Reference Label affixed to top cover</p> <p>(1) – Intel® Server Board S2600WF0R (no onboard LAN) – iPC S2600WF0R</p> <p>(2) – Riser card assembly with 1 slot PCIe* x16 riser card – iPC F1UL16RISER3</p> <p>(4) – 3.5" hot-swap drive bays with drive carriers and drive blanks. Includes:</p> <ul style="list-style-type: none"> o (1) 12 Gb SAS backplane – iPC FR1304S3HSBP o (4) 3.5" hot swap drive tool less carriers – iPC FXX35HSCAR2 <p>(1) – Preinstalled standard control panel assembly (board only – iPC FXXFPANEL2)</p> <ul style="list-style-type: none"> o 260 mm front panel cable – iPN J25698-xxx <p>(1) – Preinstalled front I/O panel assembly (1 x VGA and 2 x USB)</p> <ul style="list-style-type: none"> o 620 mm USB 3.0 cable – iPN H76899-xxx o 400 mm video cable – iPN H62114-xxx <p>(1) – 150 mm backplane I2C cable – iPN H91171-xxx</p> <p>(1) – 850 mm mini SAS HD cable – iPC AXXCBL850HDHRT</p> <p>(1) – 350 mm backplane power cable – iPN H82100-xxx</p> <p>(1) – Air duct – iPN H90054-xxx</p> <p>(6) – Dual rotor system fans – iPC FR1UFAN10PW</p> <p>(1) – 1100W power supply module – iPC AXX1100PCRPS</p> <p>(2) – CPU heat sinks, 39 fin passive – iPN J39509-xxx</p> <p>(2) – CPU heat sink “No CPU” label inserts – iPN J16115-xxx</p> <p>(2) – Standard CPU Carriers – iPN H72851-xxx</p> <p>(8) – DIMM slot blanks – iPN G75158-xxx</p> <p>(1) – Chassis Stiffener Bar – iPN J16623-xxx</p> <p>(1) – Power supply bay blank insert</p> <p>(2) – AC power cord retention strap assembly – iPN H23961-00x</p> <p>Spares for each screw type included</p>	<ul style="list-style-type: none"> • Power cord(s) – See Section 5.6 • Rack mount kit – See Section 5.7 • (1) or (2) 1st or 2nd Intel® Xeon® processor Scalable family • ECC DDR4 memory (RDIMM or LRDIMM) 	<p>Note: By default the front drive bays are cabled to onboard SATA only ports. An add-in SAS card or module is needed to support SAS devices.</p> <ul style="list-style-type: none"> • Second 1100W AC power supply module to support power redundancy – iPC AXX1100PCRPS • Intel® Ethernet Network Adapter for OCP* – See Chapter 5.4 for available options • Intel® 12G SAS RAID module and Intel® RAID Maintenance Free Backup unit – See Chapter 5.5 for available options • SAS Data cable – Depending on the location of the SAS Data controller, a new data cable may be necessary. See Chapter 4. • SATA upgrade key for Intel® Embedded Server Technology 2 RAID 5 support – iPC RKSATA4R5 • Storage drives • DDR4-compatible Intel® Optane™ DC persistent memory module (requires an installed 2nd Gen Intel® Xeon® Scalable processor) <p>See Chapters 5 and 6 for all available accessory options.</p>																							

Table 20. Intel® Server System R1304WFTYS product specifications and configuration requirements


Intel® Server System R1304WFTYS 1U, Intel® Server Board S2600WFT, 4 x 3.5" HDD or 4 x 2.5" SSD SAS/SATA front mount drives																								
	<p>This part is no longer available to order, refer to replacement part MM# 986048. See PCN116894-02 for more details.</p> <table border="0"> <tr> <td>iPC</td> <td>R1304WFTYS</td> </tr> <tr> <td>MM#</td> <td>975884</td> </tr> <tr> <td>UPC</td> <td>00735858344708</td> </tr> <tr> <td>EAN</td> <td>5032037105415</td> </tr> <tr> <td>MOQ</td> <td>1</td> </tr> </table>	iPC	R1304WFTYS	MM#	975884	UPC	00735858344708	EAN	5032037105415	MOQ	1	<table border="0"> <tr> <td>Product type</td> <td>L6 integrated system</td> </tr> <tr> <td>Chassis form factor</td> <td>1U rack mount</td> </tr> <tr> <td>Packaged gross wt.</td> <td>20.6 kg (45.3 lb)</td> </tr> <tr> <td>Un-packaged net wt.</td> <td>12.3 kg (27.1 lb)</td> </tr> <tr> <td>Chassis dimensions</td> <td>712 x 439 x 43.2 mm (L x W x H)</td> </tr> <tr> <td>Package dimensions</td> <td>983 x 577 x 260 mm (L x W x H)</td> </tr> </table>	Product type	L6 integrated system	Chassis form factor	1U rack mount	Packaged gross wt.	20.6 kg (45.3 lb)	Un-packaged net wt.	12.3 kg (27.1 lb)	Chassis dimensions	712 x 439 x 43.2 mm (L x W x H)	Package dimensions	983 x 577 x 260 mm (L x W x H)
iPC	R1304WFTYS																							
MM#	975884																							
UPC	00735858344708																							
EAN	5032037105415																							
MOQ	1																							
Product type	L6 integrated system																							
Chassis form factor	1U rack mount																							
Packaged gross wt.	20.6 kg (45.3 lb)																							
Un-packaged net wt.	12.3 kg (27.1 lb)																							
Chassis dimensions	712 x 439 x 43.2 mm (L x W x H)																							
Package dimensions	983 x 577 x 260 mm (L x W x H)																							
Included	Required Items (sold separately)	Optional Accessories (sold separately)																						
<ul style="list-style-type: none"> (1) – 1U chassis with Quick Reference Label affixed to top cover (1) – Intel® Server Board S2600WFT (dual 10 GbE LAN) – iPC S2600WFT (2) – Riser card assembly with 1 slot PCIe* x16 riser card – iPC F1UL16RISER3 (4) – 3.5" hot-swap drive bays with drive carriers and drive blanks. Includes: <ul style="list-style-type: none"> o (1) 12 Gb SAS backplane – iPC FR1304S3HSBP o (4) 3.5" hot swap drive tool less carriers – iPC FXX35HSCAR2 (1) – Preinstalled standard control panel assembly (board only – iPC FXXFPANEL2) <ul style="list-style-type: none"> o 260 mm front panel cable – iPN J25698-xxx (1) – Preinstalled front I/O panel assembly (1 x VGA and 2 x USB) <ul style="list-style-type: none"> o 620 mm USB 3.0 cable – iPN H76899-xxx o 400 mm video cable – iPN H62114-xxx (1) – 150 mm backplane I2C cable – iPN H91171-xxx (1) – 850 mm mini SAS HD cable – iPC AXXCBL850HDHRT (1) – 350 mm backplane power cable – iPN H82100-xxx (1) – SATA optical drive power cable 300 mm – iPN H23901-001 (1) – SATA optical drive bay mounting kit – iPN H19168-xxx (1) – Air duct – iPN H90054-xxx (6) – Dual rotor system fans – iPC FR1UFAN10PW (1) – 1100W power supply module – iPC AXX1100PCRPS (2) – CPU heat sinks, 39 fin passive – iPN J39509-xxx (2) – CPU heat sink "No CPU" label inserts – iPN J16115-xxx (2) – Standard CPU Carriers – iPN H72851-xxx (8) – DIMM slot blanks – iPN G75158-xxx (1) – Chassis Stiffener Bar – iPN J16623-xxx (1) – Power supply bay blank insert (2) – AC power cord retention strap assembly – iPN H23961-00x <p>Spares for each screw type included</p>	<ul style="list-style-type: none"> • Power cord(s) – See Section 5.6 • Rack mount kit – See Section 5.7 • (1) or (2) 1st or 2nd Intel® Xeon® processor Scalable family (support for 2nd Gen Intel® Xeon® processor Scalable family requires a system software stack update from http://downloadcenter.intel.com) • ECC DDR4 memory (RDIMM or LRDIMM) 	<p>Note: By default the front drive bays are cabled to onboard SATA only ports. An add-in SAS card or module is needed to support SAS devices.</p> <ul style="list-style-type: none"> • Second 1100W AC power supply module to support power redundancy – iPC AXX1100PCRPS • Intel® Ethernet Network Adapter for OCP* – See Chapter 5.4 for available options • Intel® 12G SAS RAID module and Intel® RAID Maintenance Free Backup unit – See Chapter 5.5 for available options • SAS Data cable – Depending on the location of the SAS Data controller, a new data cable may be necessary. See Chapter 4. • SATA upgrade key for Intel® Embedded Server Technology 2 RAID 5 support – iPC RKSATA4R5 • Storage drives <p>See Chapters 5 and 6 for all available accessory options.</p>																						

Table 21. Intel® Server System R1304WFTYSR product specifications and configuration requirements


Intel® Server System R1304WFTYSR 1U, Intel® Server Board S2600WFTR, 4 x 3.5" HDD or 4 x 2.5" SSD SAS/SATA front mount drives																									
	<table border="0"> <tr><td>iPC</td><td>R1304WFTYSR</td></tr> <tr><td>MM#</td><td>986048</td></tr> <tr><td>UPC</td><td>00735858406833</td></tr> <tr><td>EAN</td><td>5032037151092</td></tr> <tr><td>MOQ</td><td>1</td></tr> </table>	iPC	R1304WFTYSR	MM#	986048	UPC	00735858406833	EAN	5032037151092	MOQ	1	<table border="0"> <tr><td>Product type</td><td>L6 integrated system</td></tr> <tr><td>Chassis form factor</td><td>1U rack mount</td></tr> <tr><td>Packaged gross wt.</td><td>20.6 kg (45.3 lb)</td></tr> <tr><td>Un-packaged net wt.</td><td>12.3 kg (27.1 lb)</td></tr> <tr><td>Chassis dimensions</td><td>712 x 439 x 43.2 mm (L x W x H)</td></tr> <tr><td>Package dimensions</td><td>983 x 577 x 260 mm (L x W x H)</td></tr> </table>	Product type	L6 integrated system	Chassis form factor	1U rack mount	Packaged gross wt.	20.6 kg (45.3 lb)	Un-packaged net wt.	12.3 kg (27.1 lb)	Chassis dimensions	712 x 439 x 43.2 mm (L x W x H)	Package dimensions	983 x 577 x 260 mm (L x W x H)	
iPC	R1304WFTYSR																								
MM#	986048																								
UPC	00735858406833																								
EAN	5032037151092																								
MOQ	1																								
Product type	L6 integrated system																								
Chassis form factor	1U rack mount																								
Packaged gross wt.	20.6 kg (45.3 lb)																								
Un-packaged net wt.	12.3 kg (27.1 lb)																								
Chassis dimensions	712 x 439 x 43.2 mm (L x W x H)																								
Package dimensions	983 x 577 x 260 mm (L x W x H)																								
Included	Required Items (sold separately)	Optional Accessories (sold separately)																							
<p>(1) – 1U chassis with Quick Reference Label affixed to top cover</p> <p>(1) – Intel® Server Board S2600WFTR (dual 10 GbE LAN) – iPC S2600WFTR</p> <p>(2) – Riser card assembly with 1 slot PCIe* x16 riser card – iPC F1UL16RISER3</p> <p>(4) – 3.5" hot-swap drive bays with drive carriers and drive blanks. Includes:</p> <ul style="list-style-type: none"> o (1) 12 Gb SAS backplane – iPC FR1304S3HSBP o (4) 3.5" hot swap drive tool less carriers – iPC FXX35HSCAR2 <p>(1) – Preinstalled standard control panel assembly (board only – iPC FXXFPANEL2)</p> <ul style="list-style-type: none"> o 260 mm front panel cable – iPN J25698-xxx <p>(1) – Preinstalled front I/O panel assembly (1 x VGA and 2 x USB)</p> <ul style="list-style-type: none"> o 620 mm USB 3.0 cable – iPN H76899-xxx o 400 mm video cable – iPN H62114-xxx <p>(1) – 150 mm backplane I2C cable – iPN H91171-xxx</p> <p>(1) – 850 mm mini SAS HD cable – iPC AXXCBL850HDHRT</p> <p>(1) – 350 mm backplane power cable – iPN H82100-xxx</p> <p>(1) – SATA optical drive power cable 300 mm – iPN H23901-001</p> <p>(1) – SATA optical drive bay mounting kit – iPN H19168-xxx</p> <p>(1) – Air duct – iPN H90054-xxx</p> <p>(6) – Dual rotor system fans – iPC FR1UFAN10PW</p> <p>(1) – 1100W power supply module – iPC AXX1100PCRPS</p> <p>(2) – CPU heat sinks, 39 fin passive – iPN J39509-xxx</p> <p>(2) – CPU heat sink "No CPU" label inserts – iPN J16115-xxx</p> <p>(2) – Standard CPU Carriers – iPN H72851-xxx</p> <p>(8) – DIMM slot blanks – iPN G75158-xxx</p> <p>(1) – Chassis Stiffener Bar – iPN J16623-xxx</p> <p>(1) – Power supply bay blank insert</p> <p>(2) – AC power cord retention strap assembly – iPN H23961-00x</p> <p>Spares for each screw type included</p>	<ul style="list-style-type: none"> • Power cord(s) – See Section 5.6 • Rack mount kit – See Section 5.7 • (1) or (2) 1st or 2nd Intel® Xeon® processor Scalable family • ECC DDR4 memory (RDIMM or LRDIMM) 	<p>Note: By default the front drive bays are cabled to onboard SATA only ports. An add-in SAS card or module is needed to support SAS devices.</p> <ul style="list-style-type: none"> • Second 1100W AC power supply module to support power redundancy – iPC AXX1100PCRPS • Intel® Ethernet Network Adapter for OCP* – See Chapter 5.4 for available options • Intel® 12G SAS RAID module and Intel® RAID Maintenance Free Backup unit – See Chapter 5.5 for available options • SAS Data cable – Depending on the location of the SAS Data controller, a new data cable may be necessary. See Chapter 4. • SATA upgrade key for Intel® Embedded Server Technology 2 RAID 5 support – iPC RKSATA4R5 • Storage drives • DDR4-compatible Intel® Optane™ DC persistent memory module (requires an installed 2nd Gen Intel® Xeon® Scalable processor) <p>See Chapters 5 and 6 for all available accessory options.</p>																							

Table 22. Intel® Server System R1208WFTYS product specifications and configuration requirements


Intel® Server System R1208WFTYS 1U, Intel® Server Board S2600WFT, 8 x 2.5" SSD SATA/SAS/NVMe* front mount drives																								
	<p>This part is no longer available to order, refer to replacement part MM# 986007. See PCN116894-02 for more details.</p> <table border="0"> <tr> <td>iPC</td> <td>R1208WFTYS</td> </tr> <tr> <td>MM#</td> <td>975886</td> </tr> <tr> <td>UPC</td> <td>00735858344814</td> </tr> <tr> <td>EAN</td> <td>5032037105521</td> </tr> <tr> <td>MOQ</td> <td>1</td> </tr> </table>	iPC	R1208WFTYS	MM#	975886	UPC	00735858344814	EAN	5032037105521	MOQ	1	<table border="0"> <tr> <td>Product type</td> <td>L6 integrated system</td> </tr> <tr> <td>Chassis form factor</td> <td>1U rack mount</td> </tr> <tr> <td>Packaged gross wt.</td> <td>21.4 kg (47.1 lb)</td> </tr> <tr> <td>Un-packaged net wt.</td> <td>13.1 kg (28.9 lb)</td> </tr> <tr> <td>Chassis dimensions</td> <td>712 x 439 x 43.2 mm (L x W x H)</td> </tr> <tr> <td>Package dimensions</td> <td>983 x 577 x 260 mm (L x W x H)</td> </tr> </table>	Product type	L6 integrated system	Chassis form factor	1U rack mount	Packaged gross wt.	21.4 kg (47.1 lb)	Un-packaged net wt.	13.1 kg (28.9 lb)	Chassis dimensions	712 x 439 x 43.2 mm (L x W x H)	Package dimensions	983 x 577 x 260 mm (L x W x H)
iPC	R1208WFTYS																							
MM#	975886																							
UPC	00735858344814																							
EAN	5032037105521																							
MOQ	1																							
Product type	L6 integrated system																							
Chassis form factor	1U rack mount																							
Packaged gross wt.	21.4 kg (47.1 lb)																							
Un-packaged net wt.	13.1 kg (28.9 lb)																							
Chassis dimensions	712 x 439 x 43.2 mm (L x W x H)																							
Package dimensions	983 x 577 x 260 mm (L x W x H)																							
Included	Required Items (sold separately)	Optional Accessories (sold separately)																						
<ul style="list-style-type: none"> (1) – 1U chassis with Quick Reference Label affixed to top cover (1) – Intel® Server Board S2600WFT (dual 10GbE LAN) – iPC S2600WFT (2) – Riser card assembly with 1 slot PCIe* x16 riser card – iPC F1UL16RISER3 (8) – 2.5" hot-swap drive bays with drive carriers and drive blanks. Includes: <ul style="list-style-type: none"> o (1) SAS/NVMe* Combo backplane – iPC F1U8X25S3PHS o (8) 2.5" hot swap drive tool less carriers – iPC FXX25HSCAR3 (1) – Preinstalled standard control panel assembly (board only – iPC FXXFPANEL2) <ul style="list-style-type: none"> o 260 mm front panel cable – iPN J25698-xxx (1) – Preinstalled front I/O panel assembly (1x VGA and 2x USB) <ul style="list-style-type: none"> o 620 mm USB 3.0 cable – iPN H76899-xxx o 400 mm video cable – iPN H62114-xxx (1) – 200mm backplane I2C cable – iPN H91170-xxx (1) – 650mm mini SAS HD Cable – iPC AXXCBL650HDHRT (1) – 850mm mini SAS HD cable – iPC AXXCBL850HDHRT (1) – 400mm backplane power cable – iPN H82099-xxx (1) – SATA optical drive power cable 300 mm – iPN H23901-001 (1) – SATA optical drive bay mounting kit – iPN H19168-xxx (1) – Air duct – iPN H90054-xxx (6) – Dual rotor system fans – iPC FR1UFAN10PW (1) – 1100W power supply module – iPC AXX1100PCRPS (2) – CPU heat sinks, 39 fin passive – iPN J39509-xxx (2) – CPU heat sink "No CPU" label inserts – iPN J16115-xxx (2) – Standard CPU carriers – iPN H72851-xxx (8) – DIMM slot blanks – iPN G75158-xxx (1) – Chassis Stiffener Bar – iPN J16623-xxx (1) – Power supply bay blank insert (2) – AC power cord retention strap assembly – iPN H23961-00x <p>Spares for each screw type included</p>	<ul style="list-style-type: none"> • Power cord(s) – See Section 5.6 • Rack mount kit – See Section 5.7 • (1) or (2) 1st or 2nd Intel® Xeon® processor Scalable family (support for 2nd Gen Intel® Xeon® processor Scalable family requires a system software stack update from http://downloadcenter.intel.com) • ECC DDR4 memory (RDIMM or LRDIMM) 	<p>Note: By default the front drive bays are cabled to onboard SATA only ports. An add-in SAS card or module is needed to support SAS devices.</p> <ul style="list-style-type: none"> • Second 1100W AC power supply module to support power redundancy – iPC AXX1100PCRPS • Intel® Ethernet Network Adapter for OCP* – See Chapter 5.4 for available options • Intel® 12G SAS RAID module and Intel® RAID Maintenance Free Backup unit – See Chapter 5.5 for available options • SAS Data cable – Depending on the location of the SAS Data controller, a new data cable may be necessary. See Chapter 4. • PCIe* OCuLink data cables (1 per NVMe* drive) – See Chapter 4 • SATA upgrade key for Intel® Embedded Server Technology 2 RAID 5 support – iPC RKSATA4R5 • Storage drives <ul style="list-style-type: none"> o Up to (8) SAS/SATA/NVMe* drives supported <p>See Chapters 5 and 6 for all available accessory options.</p>																						

Table 23. Intel® Server System R1208WFTYSR product specifications and configuration requirements



Intel® Server System R1208WFTYSR 1U, Intel® Server Board S2600WFTR, 8 x 2.5" SSD SATA/SAS/NVMe* front mount drives																									
	<table border="0"> <tr><td>iPC</td><td>R1208WFTYSR</td></tr> <tr><td>MM#</td><td>986007</td></tr> <tr><td>UPC</td><td>00735858406604</td></tr> <tr><td>EAN</td><td>5032037150866</td></tr> <tr><td>MOQ</td><td>1</td></tr> </table>	iPC	R1208WFTYSR	MM#	986007	UPC	00735858406604	EAN	5032037150866	MOQ	1	<table border="0"> <tr><td>Product type</td><td>L6 integrated system</td></tr> <tr><td>Chassis form factor</td><td>1U rack mount</td></tr> <tr><td>Packaged gross wt.</td><td>21.4 kg (47.1 lb)</td></tr> <tr><td>Un-packaged net wt.</td><td>13.1 kg (28.9 lb)</td></tr> <tr><td>Chassis dimensions</td><td>712 x 439 x 43.2 mm (L x W x H)</td></tr> <tr><td>Package dimensions</td><td>983 x 577 x 260 mm (L x W x H)</td></tr> </table>	Product type	L6 integrated system	Chassis form factor	1U rack mount	Packaged gross wt.	21.4 kg (47.1 lb)	Un-packaged net wt.	13.1 kg (28.9 lb)	Chassis dimensions	712 x 439 x 43.2 mm (L x W x H)	Package dimensions	983 x 577 x 260 mm (L x W x H)	
iPC	R1208WFTYSR																								
MM#	986007																								
UPC	00735858406604																								
EAN	5032037150866																								
MOQ	1																								
Product type	L6 integrated system																								
Chassis form factor	1U rack mount																								
Packaged gross wt.	21.4 kg (47.1 lb)																								
Un-packaged net wt.	13.1 kg (28.9 lb)																								
Chassis dimensions	712 x 439 x 43.2 mm (L x W x H)																								
Package dimensions	983 x 577 x 260 mm (L x W x H)																								
Included	Required Items (sold separately)	Optional Accessories (sold separately)																							
<p>(1) – 1U chassis with Quick Reference Label affixed to top cover</p> <p>(1) – Intel® Server Board S2600WFTR (dual 10GbE LAN) – iPC S2600WFTR</p> <p>(2) – Riser card assembly with 1 slot PCIe* x16 riser card – iPC F1UL16RISER3</p> <p>(8) – 2.5" hot-swap drive bays with drive carriers and drive blanks. Includes:</p> <ul style="list-style-type: none"> o (1) SAS/NVMe* Combo backplane – iPC F1U8X25S3PHS o (8) 2.5" hot swap drive tool less carriers – iPC FXX25HSCAR3 <p>(1) – Preinstalled standard control panel assembly (board only – iPC FXXFPANEL2)</p> <ul style="list-style-type: none"> o 260 mm front panel cable – iPN J25698-xxx <p>(1) – Preinstalled front I/O panel assembly (1x VGA and 2x USB)</p> <ul style="list-style-type: none"> o 620 mm USB 3.0 cable – iPN H76899-xxx o 400 mm video cable – iPN H62114-xxx <p>(1) – 200mm backplane I2C cable – iPN H91170-xxx</p> <p>(1) – 650mm mini SAS HD Cable – iPC AXXCBL650HDHRT</p> <p>(1) – 850mm mini SAS HD cable – iPC AXXCBL850HDHRT</p> <p>(1) – 400mm backplane power cable – iPN H82099-xxx</p> <p>(1) – SATA optical drive power cable 300 mm – iPN H23901-001</p> <p>(1) – SATA optical drive bay mounting kit – iPN H19168-xxx</p> <p>(1) – Air duct – iPN H90054-xxx</p> <p>(6) – Dual rotor system fans – iPC FR1UFAN10PW</p> <p>(1) – 1100W power supply module – iPC AXX1100PCRPS</p> <p>(2) – CPU heat sinks, 39 fin passive – iPN J39509-xxx</p> <p>(2) – CPU heat sink “No CPU” label inserts – iPN J16115-xxx</p> <p>(2) – Standard CPU carriers – iPN H72851-xxx</p> <p>(8) – DIMM slot blanks – iPN G75158-xxx</p> <p>(1) – Chassis Stiffener Bar – iPN J16623-xxx</p> <p>(1) – Power supply bay blank insert</p> <p>(2) – AC power cord retention strap assembly – iPN H23961-00x</p> <p>Spares for each screw type included</p>	<ul style="list-style-type: none"> • Power cord(s) – See Section 5.6 • Rack mount kit – See Section 5.7 • (1) or (2) 1st or 2nd Intel® Xeon® processor Scalable family • ECC DDR4 memory (RDIMM or LRDIMM) 	<p>Note: By default the front drive bays are cabled to onboard SATA only ports. An add-in SAS card or module is needed to support SAS devices.</p> <ul style="list-style-type: none"> • Second 1100W AC power supply module to support power redundancy – iPC AXX1100PCRPS • Intel® Ethernet Network Adapter for OCP* – See Chapter 5.4 for available options • Intel® 12G SAS RAID module and Intel® RAID Maintenance Free Backup unit – See Chapter 5.5 for available options • SAS Data cable – Depending on the location of the SAS Data controller, a new data cable may be necessary. See Chapter 4. • PCIe* OCuLink data cables (1 per NVMe* drive) – See Chapter 4 • SATA upgrade key for Intel® Embedded Server Technology 2 RAID 5 support – iPC RKSATA4R5 • Storage drives • Up to (8) SAS/SATA/NVMe* drives supported • DDR4-compatible Intel® Optane™ DC persistent memory module (requires an installed 2nd Gen Intel® Xeon® Scalable processor) <p>See Chapters 5 and 6 for all available accessory options.</p>																							

Table 24. Intel® Server System R1208WFQYSR product specifications and configuration requirements

Intel® Server System R1208WFQYSR 1U, Intel® Server Board S2600WFQR, 8 x 2.5" SSD SATA/SAS/NVMe* front mount drives																									
	<table border="0"> <tr><td>iPC</td><td>R1208WFQYSR</td></tr> <tr><td>MM#</td><td>986059</td></tr> <tr><td>UPC</td><td>00735858406918</td></tr> <tr><td>EAN</td><td>5032037151177</td></tr> <tr><td>MOQ</td><td>1</td></tr> </table>	iPC	R1208WFQYSR	MM#	986059	UPC	00735858406918	EAN	5032037151177	MOQ	1	<table border="0"> <tr><td>Product type</td><td>L6 integrated system</td></tr> <tr><td>Chassis form factor</td><td>1U rack mount</td></tr> <tr><td>Packaged gross wt.</td><td>21.4 kg (47.1 lb)</td></tr> <tr><td>Un-packaged net wt.</td><td>13.1 kg (28.9 lb)</td></tr> <tr><td>Chassis dimensions</td><td>712 x 439 x 43.2 mm (L x W x H)</td></tr> <tr><td>Package dimensions</td><td>983 x 577 x 260 mm (L x W x H)</td></tr> </table>	Product type	L6 integrated system	Chassis form factor	1U rack mount	Packaged gross wt.	21.4 kg (47.1 lb)	Un-packaged net wt.	13.1 kg (28.9 lb)	Chassis dimensions	712 x 439 x 43.2 mm (L x W x H)	Package dimensions	983 x 577 x 260 mm (L x W x H)	
iPC	R1208WFQYSR																								
MM#	986059																								
UPC	00735858406918																								
EAN	5032037151177																								
MOQ	1																								
Product type	L6 integrated system																								
Chassis form factor	1U rack mount																								
Packaged gross wt.	21.4 kg (47.1 lb)																								
Un-packaged net wt.	13.1 kg (28.9 lb)																								
Chassis dimensions	712 x 439 x 43.2 mm (L x W x H)																								
Package dimensions	983 x 577 x 260 mm (L x W x H)																								
Included	Required Items (sold separately)	Optional Accessories (sold separately)																							
<p>(1) – 1U chassis with Quick Reference Label affixed to top cover</p> <p>(1) – Intel® Server Board S2600WFQR (Intel® QAT support) – iPC S2600WFQR</p> <p>(2) – Riser card assembly with 1 slot PCIe* x16 riser card – iPC F1UL16RISER3</p> <p>(8) – 2.5" hot-swap drive bays with drive carriers and drive blanks. Includes:</p> <ul style="list-style-type: none"> o (1) SAS/NVMe* Combo backplane – iPC F1U8X25S3PHS o (8) 2.5" hot swap drive tool less carriers – iPC FXX25HSCAR3 <p>(1) – Preinstalled standard control panel assembly (board only – iPC FXXFPANEL2)</p> <ul style="list-style-type: none"> o 260 mm front panel cable – iPN J25698-xxx <p>(1) – Preinstalled front I/O panel assembly (1x VGA and 2x USB)</p> <ul style="list-style-type: none"> o 620 mm USB 3.0 cable – iPN H76899-xxx o 400 mm video cable – iPN H62114-xxx <p>(1) – 200mm backplane I2C cable – iPN H91170-xxx</p> <p>(1) – 400mm backplane power cable – iPN H82099-xxx</p> <p>(1) – 290 mm Intel® QAT cable – iPN J61138-xxx</p> <p>(1) – Air duct – iPN H90054-xxx</p> <p>(6) – Dual rotor system fans – iPC FR1UFAN10PW</p> <p>(1) – 1100 W power supply module – iPC AXX1100PCRPS</p> <p>(2) – CPU heat sinks, 39 fin passive – iPN J39509-xxx</p> <p>(2) – CPU heat sink “No CPU” label inserts – iPN J16115-xxx</p> <p>(2) – Standard CPU carriers – iPN H72851-xxx</p> <p>(8) – DIMM slot blanks – iPN G75158-xxx</p> <p>(1) – Chassis Stiffener Bar – iPN J16623-xxx</p> <p>(1) – Power supply bay blank insert</p> <p>(2) – AC power cord retention strap assembly – iPN H23961-00x</p> <p>Spares for each screw type included</p>	<ul style="list-style-type: none"> • Power cord(s) – See Section 5.6 • Rack mount kit – See Section 5.7 • (1) or (2) 1st or 2nd Intel® Xeon® processor Scalable family • ECC DDR4 memory (RDIMM or LRDIMM) 	<p>Note: 4-port mini-SAS HD connectors are present on S2600WFQ but are not configured as SATA; these cables are used only for Intel® QAT. An add-in SAS card or module is needed to support SATA/SAS front devices.</p> <ul style="list-style-type: none"> • Second 1100 W AC power supply module to support power redundancy – iPC AXX1100PCRPS • Intel® Ethernet Network Adapter for OCP* – See Chapter 5.4 for available options • Intel® 12G SAS RAID module and Intel® RAID Maintenance Free Backup unit – See Chapter 5.5 for available options • SAS Data cable – Depending on the location of the SAS Data controller, a new data cable may be necessary. See Chapter 4. • PCIe* OCuLink data cables (1 per NVMe* drive) – See Chapter 4 • SATA upgrade key for Intel® Embedded Server Technology 2 RAID 5 support – iPC RKSATA4R5 • Storage drives <ul style="list-style-type: none"> o Up to (8) SAS/SATA/NVMe* drives supported • DDR4-compatible Intel® Optane™ DC persistent memory module (requires an installed 2nd Gen Intel® Xeon® Scalable processor) 																							
		See Chapters 5 and 6 for all available accessory options.																							

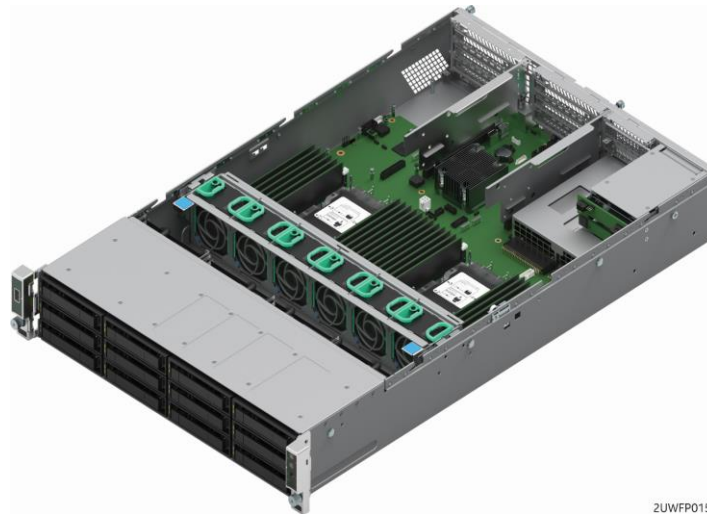
3.2 Intel® Server System R2000WF Product Family – (2U Rack Mount System)

The product tables found in this section provide order code information and detailed descriptions for the specified L6 Integrated 2U Intel® server system. The lower sections of each table identify:

- The ship along components of the specified chassis product code – (product BOM)
- **Required Items** – The options required to be installed to the base system to achieve basic functionality using the default system feature set
- **Optional Accessories** – Some of the available accessories that can be installed to enhance the basic feature set of the server board / chassis. Additional accessories can be found in Chapter 4

NOTES:

- Each **required item** and **optional accessory** are sold separately for the specified Intel® L6 server system
- Items identified as **iPC** (Intel Product Code), are an orderable building block option, accessory or spare FRU
- In an effort to provide the complete product bill of materials, the ship along components list in each product table will include items identified by description and by **iPN** (Intel Part Number). The iPN information is provided for reference only. These components are **not** orderable as a spare or accessory.
- **L6** – Integrated system: Chassis and server board, with no processors, memory, or storage devices
- **L9** – Integrated system: Chassis and server board, with processors and memory, no storage devices.



2UWFP0153

Figure 20. Intel® Server System R2000WF – L6 integrated 2U system (R2312WFxxx shown)

Table 25. Intel® Server System R2308WFTZS product specifications and configuration requirements


Intel® Server System R2308WFTZS 2U, Intel® Server Board S2600WFT, 8 x 3.5" HDD or 8 x 2.5" SSD SATA/SAS front mount drives		
	<p>This part is no longer available to order, refer to replacement part MM# 986052. See PCN116894-02 for more details.</p> <p>iPC R2308WFTZS MM# 975887 UPC 00735858344807 EAN 5032037105514 MOQ 1</p>	<p>Product type L6 integrated system Chassis form factor 2U rack mount Packaged gross wt. 22.9 kg (50.3 lb) Un-packaged net wt. 16.3 kg (35.9 lb) Chassis dimensions 712 x 439 x 89 mm (L x W x H) Package dimensions 983 x 577 x 260 mm (L x W x H)</p>
Included	Required Items (sold separately)	Optional Accessories (sold separately)
<p>(1) – 2U Chassis with Quick Reference Label affixed to top cover (1) – Intel® Server Board S2600WFT (dual 10 GbE LAN) – iPC S2600WFT (2) – PCIe* Riser card brackets. Includes: o (2) 3-slot PCIe* riser cards – iPC A2U8RISER2 o (1) 2-slot low profile PCIe* riser card – iPC A2UX8X4RISER (8) – 3.5" hot-swap drive bays with drive carriers and blanks. Includes: o (1) 12Gb SAS backplane – iPC A2U8X35S3HSDK1 o (8) 3.5" hot-swap drive tool less carriers – iPC FXX35HSCAR2 (1) – Standard control panel assembly (board only – iPC FXXFPANEL2) o 300 mm front panel cable – iPN H34381-xxx (1) – Front I/O panel assembly (1 x VGA and 2 x USB) o 620 mm USB 3.0 cable – iPN H76899-xxx o 400 mm video cable – iPN H62114-xxx (1) – 175 mm backplane I2C cable – iPN H91172-xxx (1) – 730 mm mini SAS HD cable iPC AXXCBL730HDHD (1) – 875 mm mini SAS HD cable iPC AXXCBL875HDHD (1) – 400 mm Backplane power cable – iPN H82099-xxx (1) – SATA optical drive power cable 300 mm – iPN H23901-001 (1) – SATA optical drive bay mounting kit – iPN H19168-xxx (1) – Standard 2U air duct – iPN H90554-xxx (6) – Hot swap system fans – iPC FR2UFAN60HSW (8) – DIMM slot blanks – iPN G75158-00x (1) – 1300W AC power supply module – iPC AXX1300TCRPS (1) – Power supply bay blank insert (2) – AC power cord retention strap assembly – iPN H23961-00x (2) – CPU heat sinks – iPC FXXCA78X108HS (2) – CPU heat sink "NO CPU" Mylar* spacer insert – iPN J16115-XXX (2) – Standard CPU carrier – iPN H72851-xxx (1) – 3x Intel® RAID Maintenance Free Backup unit mounting bracket – iPN H18238-00x (1) – 250 mm fixed mount SSD power cable – iPN J29245-xxx Spares for each screw type included</p>	<ul style="list-style-type: none"> • Power cord(s) – See Section 5.6 • Rack mount kit – See Section 5.7 • (1) or (2) 1st or 2nd Intel® Xeon® processor Scalable family (support for 2nd Gen Intel® Xeon® processor Scalable family requires a system software stack update from http://downloadcenter.intel.com) • ECC DDR4 memory (RDIMM or LRDIMM) 	<p>Note: By default the front drive bays are cabled to onboard SATA only ports. An add-in SAS card or module is needed to support SAS devices.</p> <ul style="list-style-type: none"> • Second 1300W AC power supply module to support power redundancy – iPC AXX1300TCRPS • Intel® Ethernet Network Adapter for OCP* – See Chapter 5.4 for available options • Intel® 12G SAS RAID module and Intel® RAID Maintenance Free Backup unit – See Chapter 5.5 for available options • SAS data cables – Depending on the location of the SAS data controller, new data cables may be necessary. See Chapter 4. • SATA upgrade key for Intel® Embedded Server Technology 2 RAID 5 support – iPC RKSATA4R5 • Rear mount hot-swap drive bay accessory kit – iPC A2UREARHSDK2 • Storage drives <p>See Chapters 5 and 6 for all available accessory options.</p>

Table 26. Intel® Server System R2308WFTZSR product specifications and configuration requirements


Intel® Server System R2308WFTZSR 2U, Intel® Server Board S2600WFTR, 8 x 3.5" HDD or 8 x 2.5" SSD SATA/SAS front mount drives																									
	<table border="0"> <tr><td>iPC</td><td>R2308WFTZSR</td></tr> <tr><td>MM#</td><td>986052</td></tr> <tr><td>UPC</td><td>00735858406871</td></tr> <tr><td>EAN</td><td>5032037151139</td></tr> <tr><td>MOQ</td><td>1</td></tr> </table>	iPC	R2308WFTZSR	MM#	986052	UPC	00735858406871	EAN	5032037151139	MOQ	1	<table border="0"> <tr><td>Product type</td><td>L6 integrated system</td></tr> <tr><td>Chassis form factor</td><td>2U rack mount</td></tr> <tr><td>Packaged gross wt.</td><td>22.9 kg (50.3 lb)</td></tr> <tr><td>Un-packaged net wt.</td><td>16.3 kg (35.9 lb)</td></tr> <tr><td>Chassis dimensions</td><td>712 x 439 x 89 mm (L x W x H)</td></tr> <tr><td>Package dimensions</td><td>983 x 577 x 260 mm (L x W x H)</td></tr> </table>	Product type	L6 integrated system	Chassis form factor	2U rack mount	Packaged gross wt.	22.9 kg (50.3 lb)	Un-packaged net wt.	16.3 kg (35.9 lb)	Chassis dimensions	712 x 439 x 89 mm (L x W x H)	Package dimensions	983 x 577 x 260 mm (L x W x H)	
iPC	R2308WFTZSR																								
MM#	986052																								
UPC	00735858406871																								
EAN	5032037151139																								
MOQ	1																								
Product type	L6 integrated system																								
Chassis form factor	2U rack mount																								
Packaged gross wt.	22.9 kg (50.3 lb)																								
Un-packaged net wt.	16.3 kg (35.9 lb)																								
Chassis dimensions	712 x 439 x 89 mm (L x W x H)																								
Package dimensions	983 x 577 x 260 mm (L x W x H)																								
Included	Required Items (sold separately)	Optional Accessories (sold separately)																							
<ul style="list-style-type: none"> (1) – 2U Chassis with Quick Reference Label affixed to top cover (1) – Intel® Server Board S2600WFTR (dual 10 GbE LAN) – iPC S2600WFTR (2) – PCIe* Riser card brackets. Includes: <ul style="list-style-type: none"> o (2) 3-slot PCIe* riser cards – iPC A2UL8RISER2 o (1) 2-slot low profile PCIe* riser card – iPC A2UX8X4RISER (8) – 3.5" hot-swap drive bays with drive carriers and blanks. Includes: <ul style="list-style-type: none"> o (1) 12Gb SAS backplane – iPC A2U8X35S3HSDK1 o (8) 3.5" hot-swap drive tool less carriers – iPC FXX35HSCAR2 (1) – Standard control panel assembly (board only – iPC FXXFPANEL2) <ul style="list-style-type: none"> o 300 mm front panel cable – iPN H34381-xxx (1) – Front I/O panel assembly (1 x VGA and 2 x USB) <ul style="list-style-type: none"> o 620 mm USB 3.0 cable – iPN H76899-xxx o 400 mm video cable – iPN H62114-xxx (1) – 175 mm backplane I2C cable – iPN H91172-xxx (1) – 730 mm mini SAS HD cable iPC AXXCBL730HDHD (1) – 875 mm mini SAS HD cable iPC AXXCBL875HDHD (1) – 400 mm Backplane power cable – iPN H82099-xxx (1) – SATA optical drive power cable 300 mm – iPN H23901-001 (1) – SATA optical drive bay mounting kit – iPN H19168-xxx (1) – Standard 2U air duct – iPN H90554-xxx (6) – Hot swap system fans – iPC FR2UFAN60HSW (8) – DIMM slot blanks – iPN G75158-00x (1) – 1300W AC power supply module – iPC AXX1300TCRPS (1) – Power supply bay blank insert (2) – AC power cord retention strap assembly – iPN H23961-00x (2) – CPU heat sinks – iPC FXXCA78X108HS (2) – CPU heat sink “NO CPU” Mylar* spacer insert – iPN J16115-XXX (2) – Standard CPU carrier – iPN H72851-xxx (1) – 3x Intel® RAID Maintenance Free Backup unit mounting bracket – iPN H18238-00x (1) – 250 mm fixed mount SSD power cable – iPN J29245-xxx Spares for each screw type included	<ul style="list-style-type: none"> • Power cord(s) – See Section 5.6 • Rack mount kit – See Section 5.7 • (1) or (2) 1st or 2nd Intel® Xeon® processor Scalable family • ECC DDR4 memory (RDIMM or LRDIMM) 	<p>Note: By default the front drive bays are cabled to onboard SATA only ports. An add-in SAS card or module is needed to support SAS devices.</p> <ul style="list-style-type: none"> • Second 1300W AC power supply module to support power redundancy – iPC AXX1300TCRPS • Intel® Ethernet Network Adapter for OCP* – See Chapter 5.4 for available options • Intel® 12G SAS RAID module and Intel® RAID Maintenance Free Backup unit – See Chapter 5.5 for available options • SAS data cables – Depending on the location of the SAS data controller, new data cables may be necessary. See Chapter 4. • SATA upgrade key for Intel® Embedded Server Technology 2 RAID 5 support – iPC RKSATA4R5 • Rear mount hot-swap drive bay accessory kit – iPC A2UREARHSDK2 • Storage drives • DDR4-compatible Intel® Optane™ DC persistent memory module (requires an installed 2nd Gen Intel® Xeon® Scalable processor) <p>See Chapters 5 and 6 for all available accessory options.</p>																							

Table 27. Intel® Server System R2208WFOZS product specifications and configuration requirements


Intel® Server System R2208WFOZS 2U, Intel® Server Board S2600WF0, 8 x 2.5" SATA/SAS/NVMe* front mount drives														
	<p>This part is no longer available to order, refer to replacement part MM# 986050. See PCN116894-02 for more details.</p> <p> iPC R2208WFOZS MM# 975888 UPC 00735858344739 EAN 5032037105446 MOQ 1 </p>	<table border="0"> <tr> <td>Product type</td> <td>L6 integrated system</td> </tr> <tr> <td>Chassis form factor</td> <td>2U rack mount</td> </tr> <tr> <td>Packaged gross wt.</td> <td>22.4 kg (49.2 lb)</td> </tr> <tr> <td>Un-packaged net wt.</td> <td>15.8 kg (34.7 lb)</td> </tr> <tr> <td>Chassis dimensions</td> <td>712 x 439 x 89 mm (L x W x H)</td> </tr> <tr> <td>Package dimensions</td> <td>983 x 577 x 260 mm (L x W x H)</td> </tr> </table>	Product type	L6 integrated system	Chassis form factor	2U rack mount	Packaged gross wt.	22.4 kg (49.2 lb)	Un-packaged net wt.	15.8 kg (34.7 lb)	Chassis dimensions	712 x 439 x 89 mm (L x W x H)	Package dimensions	983 x 577 x 260 mm (L x W x H)
Product type	L6 integrated system													
Chassis form factor	2U rack mount													
Packaged gross wt.	22.4 kg (49.2 lb)													
Un-packaged net wt.	15.8 kg (34.7 lb)													
Chassis dimensions	712 x 439 x 89 mm (L x W x H)													
Package dimensions	983 x 577 x 260 mm (L x W x H)													
Included	Required Items (sold separately)	Optional Accessories (sold separately)												
<ul style="list-style-type: none"> (1) – 2U Chassis with Quick Reference Label affixed to top cover (1) – Intel® Server Board S2600WF0 (no onboard LAN) – iPC S2600WF0 (2) – PCIe* riser card brackets. Includes: <ul style="list-style-type: none"> o (2) 3-slot PCIe* riser cards – iPC A2UL8RISER2 o (1) 2-slot low profile PCIe* riser card – iPC A2UX8X4RISER (8) – 2.5" hot-swap drive bays with drive carriers and blanks. Includes: <ul style="list-style-type: none"> o (1) SAS/NVMe* combo backplane – iPC F2U8X25S3PHS o (8) 2.5" hot-swap drive tool less carriers – iPC FXX25HSCAR3 (1) – Standard control panel assembly (board only – iPC FXXFPANEL2) <ul style="list-style-type: none"> o 300 mm front panel cable – iPN H34381-xxx (1) – Front I/O panel assembly (1 x VGA and 2 x USB) <ul style="list-style-type: none"> o 620 mm USB 3.0 cable – iPN H76899-xxx o 400 mm video cable – iPN H62114-xxx (1) – 250 mm backplane I2C cable – iPN H91166-xxx (2) – 730 mm mini SAS HD cable – iPC AXXCBL730HDHD (1) – 675 mm backplane power cable – iPN H82108-XXX (1) – SATA optical drive power cable 300 mm – iPN H23901-001 (1) – SATA optical drive bay mounting kit – iPN H19168-xxx (1) – Standard 2U Air duct – iPN H90554-xxx (6) – Hot swap system fans – iPC FR2UFAN60HSW (8) – DIMM slot blanks – iPN G75158-00x (1) – 1300W AC power supply module – iPC AXX1300TCRPS (1) – Power supply bay blank insert (2) – AC power cord retention strap assembly – iPN H23961-00x (2) – CPU heat sinks – iPC FXXCA78X108HS (2) – CPU heat sink "NO CPU" Mylar* spacer insert – iPN J16115-XXX (2) – Standard CPU carrier – iPN H72851-xxx (1) – 3x Intel® RAID Maintenance Free Backup unit mounting bracket – iPN H18238-00x (1) – 250 mm fixed mount SSD power cable – iPN J29245-xxx <p>Spares for each screw type included</p>	<ul style="list-style-type: none"> • Power cord(s) – See Section 5.6 • Rack mount kit – See Section 5.7 • (1) or (2) 1st or 2nd Intel® Xeon® processor Scalable family (support for 2nd Gen Intel® Xeon® processor Scalable family requires a system software stack update from http://downloadcenter.intel.com) • ECC DDR4 memory (RDIMM or LRDIMM) 	<p>Note: By default the front drive bays are cabled to onboard SATA only ports. An add-in SAS card or module is needed to support SAS devices.</p> <ul style="list-style-type: none"> • Second 1300W AC power supply module to support power redundancy – iPC AXX1300TCRPS • Intel® Ethernet Network Adapter for OCP* – See Chapter 5.4 for available options • Intel® 12G SAS RAID module and Intel® RAID Maintenance Free Backup unit – See Chapter 5.5 for available options • SAS data cables – Depending on the location of the SAS data controller, new data cables may be necessary. See Chapter 4. • PCIe* OCuLink data cables (1 per NVMe* drive) – See Chapter 4 • 8 x 2.5" drive bay module upgrade kit – See Section 4.7 for available options • SATA upgrade key for Intel® Embedded Server Technology 2 RAID 5 support – iPC RKSATA4R5 • Rear mount hot-swap drive bay accessory kit – iPC A2UREARHSDK2 • Storage drives <p>See Chapters 5 and 6 for all available accessory options.</p>												

Table 28. Intel® Server System R2208WF0ZSR product specifications and configuration requirements


Intel® Server System R2208WF0ZSR 2U, Intel® Server Board S2600WF0R, 8 x 2.5" SATA/SAS/NVMe* front mount drives																								
	<table border="0"> <tr><td>iPC</td><td>R2208WF0ZSR</td></tr> <tr><td>MM#</td><td>986050</td></tr> <tr><td>UPC</td><td>00735858406857</td></tr> <tr><td>EAN</td><td>5032037151115</td></tr> <tr><td>MOQ</td><td>1</td></tr> </table>	iPC	R2208WF0ZSR	MM#	986050	UPC	00735858406857	EAN	5032037151115	MOQ	1	<table border="0"> <tr><td>Product type</td><td>L6 integrated system</td></tr> <tr><td>Chassis form factor</td><td>2U rack mount</td></tr> <tr><td>Packaged gross wt.</td><td>22.4 kg (49.2 lb)</td></tr> <tr><td>Un-packaged net wt.</td><td>15.8 kg (34.7 lb)</td></tr> <tr><td>Chassis dimensions</td><td>712 x 439 x 89 mm (L x W x H)</td></tr> <tr><td>Package dimensions</td><td>983 x 577 x 260 mm (L x W x H)</td></tr> </table>	Product type	L6 integrated system	Chassis form factor	2U rack mount	Packaged gross wt.	22.4 kg (49.2 lb)	Un-packaged net wt.	15.8 kg (34.7 lb)	Chassis dimensions	712 x 439 x 89 mm (L x W x H)	Package dimensions	983 x 577 x 260 mm (L x W x H)
iPC	R2208WF0ZSR																							
MM#	986050																							
UPC	00735858406857																							
EAN	5032037151115																							
MOQ	1																							
Product type	L6 integrated system																							
Chassis form factor	2U rack mount																							
Packaged gross wt.	22.4 kg (49.2 lb)																							
Un-packaged net wt.	15.8 kg (34.7 lb)																							
Chassis dimensions	712 x 439 x 89 mm (L x W x H)																							
Package dimensions	983 x 577 x 260 mm (L x W x H)																							
Included	Required Items (sold separately)	Optional Accessories (sold separately)																						
<ul style="list-style-type: none"> (1) – 2U Chassis with Quick Reference Label affixed to top cover (1) – Intel® Server Board S2600WF0R (no onboard LAN) – iPC S2600WF0R (2) – PCIe* riser card brackets. Includes: <ul style="list-style-type: none"> o (2) 3-slot PCIe* riser cards – iPC A2UL8RISER2 o (1) 2-slot low profile PCIe* riser card – iPC A2UX8X4RISER (8) – 2.5" hot-swap drive bays with drive carriers and blanks. Includes: <ul style="list-style-type: none"> o (1) SAS/NVMe* combo backplane – iPC F2U8X25S3PHS o (8) 2.5" hot-swap drive tool less carriers – iPC FXX25HSCAR3 (1) – Standard control panel assembly (board only – iPC FXXFPANEL2) <ul style="list-style-type: none"> o 300 mm front panel cable – iPN H34381-xxx (1) – Front I/O panel assembly (1 x VGA and 2 x USB) <ul style="list-style-type: none"> o 620 mm USB 3.0 cable – iPN H76899-xxx o 400 mm video cable – iPN H62114-xxx (1) – 250 mm backplane I2C cable – iPN H91166-xxx (2) – 730 mm mini SAS HD cable – iPC AXXCBL730HDHD (1) – 675 mm backplane power cable – iPN H82108-XXX (1) – SATA optical drive power cable 300 mm – iPN H23901-001 (1) – SATA optical drive bay mounting kit – iPN H19168-xxx (1) – Standard 2U Air duct – iPN H90554-xxx (6) – Hot swap system fans – iPC FR2UFAN60HSW (8) – DIMM slot blanks – iPN G75158-00x (1) – 1300W AC power supply module – iPC AXX1300TCRPS (1) – Power supply bay blank insert (2) – AC power cord retention strap assembly – iPN H23961-00x (2) – CPU heat sinks – iPC FXXCA78X108HS (2) – CPU heat sink "NO CPU" Mylar* spacer insert – iPN J16115-XXX (2) – Standard CPU carrier – iPN H72851-xxx (1) – 3x Intel® RAID Maintenance Free Backup unit mounting bracket – iPN H18238-00x (1) – 250 mm fixed mount SSD power cable – iPN J29245-xxx Spares for each screw type included	<ul style="list-style-type: none"> • Power cord(s) – See Section 5.6 • Rack mount kit – See Section 5.7 • (1) or (2) 1st or 2nd Intel® Xeon® processor Scalable family • ECC DDR4 memory (RDIMM or LRDIMM) 	<p>Note: By default the front drive bays are cabled to onboard SATA only ports. An add-in SAS card or module is needed to support SAS devices.</p> <ul style="list-style-type: none"> • Second 1300W AC power supply module to support power redundancy – iPC AXX1300TCRPS • Intel® Ethernet Network Adapter for OCP* – See Chapter 5.4 for available options • Intel® 12G SAS RAID module and Intel® RAID Maintenance Free Backup unit – See Chapter 5.5 for available options • SAS data cables – Depending on the location of the SAS data controller, new data cables may be necessary. See Chapter 4. • PCIe* OCuLink data cables (1 per NVMe* drive) – See Chapter 4 • 8 x 2.5" drive bay module upgrade kit – See Section 4.7 for available options • SATA upgrade key for Intel® Embedded Server Technology 2 RAID 5 support – iPC RKSATA4R5 • Rear mount hot-swap drive bay accessory kit – iPC A2UREARHSDK2 • Storage drives • DDR4-compatible Intel® Optane™ DC persistent memory module (requires an installed 2nd Gen Intel® Xeon® Scalable processor) <p>See Chapters 5 and 6 for all available accessory options.</p>																						

Table 29. Intel® Server System R2208WFTZS product specifications and configuration requirements

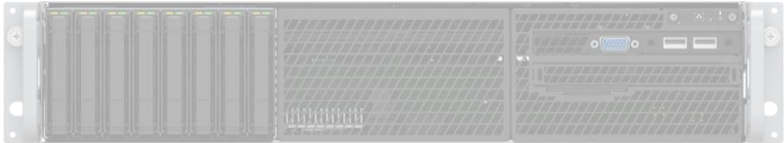
Intel® Server System R2208WFTZS 2U, Intel® Server Board S2600WFT, 8 x 2.5" SATA/SAS/NVMe* front mount drives		
	<p>This part is no longer available to order, refer to replacement part MM# 986049. See PCN116894-02 for more details.</p> <p> iPC R2208WFTZS MM# 975889 UPC 00735858344784 EAN 5032037105491 MOQ 1 </p>	<p> Product type L6 integrated system Chassis form factor 2U rack mount Packaged gross wt. 22.4 kg (49.2 lb) Un-packaged net wt. 15.8 kg (34.7 lb) Chassis dimensions 712 x 439 x 89 mm (L x W x H) Package dimensions 983 x 577 x 260 mm (L x W x H) </p>
Included	Required Items (sold separately)	Optional Accessories (sold separately)
<ul style="list-style-type: none"> (1) – 2U Chassis with Quick Reference Label affixed to top cover (1) – Intel® Server Board S2600WFT (dual 10 GbE LAN) – iPC S2600WFT (2) – PCIe* riser card brackets. Includes: <ul style="list-style-type: none"> o (2) 3-slot PCIe* riser cards – iPC A2UL8RISER2 o (1) 2-slot low profile PCIe* riser card – iPC A2UX8X4RISER (8) – 2.5" hot-swap drive bays with drive carriers and blanks. Includes: <ul style="list-style-type: none"> o (1) SAS/NVMe* combo backplane – iPC F2U8X25S3PHS o (8) 2.5" hot-swap drive tool less carriers – iPC FXX25HSCAR3 (1) – Standard control panel assembly (board only – iPC FXXFPANEL2) <ul style="list-style-type: none"> o 300 mm front panel cable – iPN H34381-xxx (1) – Front I/O panel assembly (1 x VGA and 2 x USB) <ul style="list-style-type: none"> o 620 mm USB 3.0 cable – iPN H76899-xxx o 400 mm video cable – iPN H62114-xxx (1) – 250 mm backplane I2C cable – iPN H91166-xxx (2) – 730 mm mini SAS HD cable – iPC AXXCBL730HDHD (1) – 400/525/675 mm backplane power cable – iPN H82108-XXX (1) – SATA optical drive power cable 300 mm – iPN H23901-001 (1) – SATA optical drive bay mounting kit – iPN H19168-xxx (1) – Standard 2U air duct – iPN H90554-xxx (6) – Hot-swap system fans – iPC FR2UFAN60HSW (8) – DIMM slot blanks – iPN G75158-00x (1) – 1300W AC power supply module – iPC AXX1300TCRPS (1) – Power supply bay blank insert (2) – AC Power cord retention strap assembly – iPN H23961-00x (2) – CPU heat sinks – iPC FXXCA78X108HS (2) – CPU heat sink "NO CPU" Mylar* spacer insert – iPN J16115-XXX (2) – Standard CPU carrier – iPN H72851-xxx (1) – 3x Intel® RAID Maintenance Free Backup unit mounting bracket – iPN H18238-00x (1) – 250 mm fixed mount SSD power cable – iPN J29245-xxx <p>Spares for each screw type included</p>	<ul style="list-style-type: none"> • Power cord(s) – See Section 5.6 • Rack mount kit – See Section 5.7 • (1) or (2) 1st or 2nd Intel® Xeon® processor Scalable family (support for 2nd Gen Intel® Xeon® processor Scalable family requires a system software stack update from http://downloadcenter.intel.com) • ECC DDR4 memory (RDIMM or LRDIMM) 	<p>Note: By default the front drive bays are cabled to onboard SATA only ports. An add-in SAS card or module is needed to support SAS devices.</p> <ul style="list-style-type: none"> • Second 1300W AC power supply module to support power redundancy – iPC AXX1300TCRPS • Intel® Ethernet Network Adapter for OCP* – See Chapter 5.4 for available options • Intel® 12G SAS RAID module and Intel® RAID Maintenance Free Backup unit – See Chapter 5.5 for available options • SAS data cables – Depending on the location of the SAS data controller, new data cables may be necessary. See Chapter 4. • PCIe* OCuLink data cables (1 per NVMe* drive) – See Chapter 4 • 8 x 2.5" drive bay module upgrade kit – See Section 4.7 for available options • SATA upgrade key for Intel® Embedded Server Technology 2 RAID 5 support – iPC RKSATA4R5 • Rear mount hot-swap drive bay accessory kit – iPC A2UREARHSDK2 • Storage drives <p>See Chapters 5 and 6 for all available accessory options.</p>

Table 30. Intel® Server System R2208WFTZSR product specifications and configuration requirements


Intel® Server System R2208WFTZSR 2U, Intel® Server Board S2600WFTR, 8 x 2.5" SATA/SAS/NVMe* front mount drives																									
	<table border="0"> <tr><td>iPC</td><td>R2208WFTZSR</td></tr> <tr><td>MM#</td><td>986049</td></tr> <tr><td>UPC</td><td>00735858406840</td></tr> <tr><td>EAN</td><td>5032037151108</td></tr> <tr><td>MOQ</td><td>1</td></tr> </table>	iPC	R2208WFTZSR	MM#	986049	UPC	00735858406840	EAN	5032037151108	MOQ	1	<table border="0"> <tr><td>Product type</td><td>L6 integrated system</td></tr> <tr><td>Chassis form factor</td><td>2U rack mount</td></tr> <tr><td>Packaged gross wt.</td><td>22.4 kg (49.2 lb)</td></tr> <tr><td>Un-packaged net wt.</td><td>15.8 kg (34.7 lb)</td></tr> <tr><td>Chassis dimensions</td><td>712 x 439 x 89 mm (L x W x H)</td></tr> <tr><td>Package dimensions</td><td>983 x 577 x 260 mm (L x W x H)</td></tr> </table>	Product type	L6 integrated system	Chassis form factor	2U rack mount	Packaged gross wt.	22.4 kg (49.2 lb)	Un-packaged net wt.	15.8 kg (34.7 lb)	Chassis dimensions	712 x 439 x 89 mm (L x W x H)	Package dimensions	983 x 577 x 260 mm (L x W x H)	
iPC	R2208WFTZSR																								
MM#	986049																								
UPC	00735858406840																								
EAN	5032037151108																								
MOQ	1																								
Product type	L6 integrated system																								
Chassis form factor	2U rack mount																								
Packaged gross wt.	22.4 kg (49.2 lb)																								
Un-packaged net wt.	15.8 kg (34.7 lb)																								
Chassis dimensions	712 x 439 x 89 mm (L x W x H)																								
Package dimensions	983 x 577 x 260 mm (L x W x H)																								
Included	Required Items (sold separately)	Optional Accessories (sold separately)																							
<p>(1) – 2U Chassis with Quick Reference Label affixed to top cover</p> <p>(1) – Intel® Server Board S2600WFTR (dual 10 GbE LAN) – iPC S2600WFTR</p> <p>(2) – PCIe* riser card brackets. Includes:</p> <ul style="list-style-type: none"> o (2) 3-slot PCIe* riser cards – iPC A2UL8RISER2 o (1) 2-slot low profile PCIe* riser card – iPC A2UX8X4RISER <p>(8) – 2.5" hot-swap drive bays with drive carriers and blanks. Includes:</p> <ul style="list-style-type: none"> o (1) SAS/NVMe* combo backplane – iPC F2U8X25S3PHS o (8) 2.5" hot-swap drive tool less carriers – iPC FXX25HSCAR3 <p>(1) – Standard control panel assembly (board only – iPC FXXFPANEL2)</p> <ul style="list-style-type: none"> o 300 mm front panel cable – iPN H34381-xxx <p>(1) – Front I/O panel assembly (1 x VGA and 2 x USB)</p> <ul style="list-style-type: none"> o 620 mm USB 3.0 cable – iPN H76899-xxx o 400 mm video cable – iPN H62114-xxx <p>(1) – 250 mm backplane I2C cable – iPN H91166-xxx</p> <p>(2) – 730 mm mini SAS HD cable – iPC AXXCBL730HDHD</p> <p>(1) – 400/525/675 mm backplane power cable – iPN H82108-XXX</p> <p>(1) – SATA optical drive power cable 300 mm – iPN H23901-001</p> <p>(1) – SATA optical drive bay mounting kit – iPN H19168-xxx</p> <p>(1) – Standard 2U air duct – iPN H90554-xxx</p> <p>(6) – Hot-swap system fans – iPC FR2UFAN60HSW</p> <p>(8) – DIMM slot blanks – iPN G75158-00x</p> <p>(1) – 1300W AC power supply module – iPC AXX1300TCRPS</p> <p>(1) – Power supply bay blank insert</p> <p>(2) – AC Power cord retention strap assembly – iPN H23961-00x</p> <p>(2) – CPU heat sinks – iPC FXXCA78X108HS</p> <p>(2) – CPU heat sink “NO CPU” Mylar* spacer insert – iPN J16115-XXX</p> <p>(2) – Standard CPU carrier – iPN H72851-xxx</p> <p>(1) – 3x Intel® RAID Maintenance Free Backup unit mounting bracket – iPN H18238-00x</p> <p>(1) – 250 mm fixed mount SSD power cable – iPN J29245-xxx</p> <p>Spares for each screw type included</p>	<ul style="list-style-type: none"> • Power cord(s) – See Section 5.6 • Rack mount kit – See Section 5.7 • (1) or (2) 1st or 2nd Intel® Xeon® processor Scalable family • ECC DDR4 memory (RDIMM or LRDIMM) 	<p>Note: By default the front drive bays are cabled to onboard SATA only ports. An add-in SAS card or module is needed to support SAS devices.</p> <ul style="list-style-type: none"> • Second 1300W AC power supply module to support power redundancy – iPC AXX1300TCRPS • Intel® Ethernet Network Adapter for OCP* – See Chapter 5.4 for available options • Intel® 12G SAS RAID module and Intel® RAID Maintenance Free Backup unit – See Chapter 5.5 for available options • SAS data cables – Depending on the location of the SAS data controller, new data cables may be necessary. See Chapter 4. • PCIe* OCuLink data cables (1 per NVMe* drive) – See Chapter 4 • 8 x 2.5" drive bay module upgrade kit – See Section 4.7 for available options • SATA upgrade key for Intel® Embedded Server Technology 2 RAID 5 support – iPC RKSATA4R5 • Rear mount hot-swap drive bay accessory kit – iPC A2UREARHSDK2 • Storage drives • DDR4-compatible Intel® Optane™ DC persistent memory module (requires an installed 2nd Gen Intel® Xeon® Scalable processor) <p>See Chapters 5 and 6 for all available accessory options.</p>																							

Table 31. Intel® Server System R2208WFQZS product specifications and configuration requirements

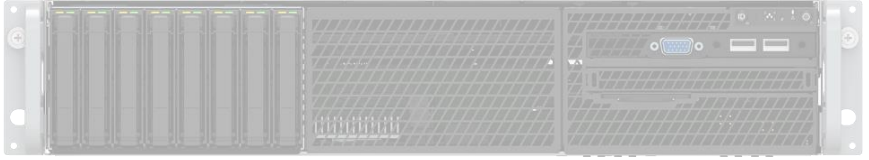
Intel® Server System R2208WFQZS 2U, Intel® Server Board S2600WFQ, 8 x 2.5" SATA/SAS/NVMe* front mount drives		
	<p>This part is no longer available to order, refer to replacement part MM# 986055. See PCN116894-02 for more details.</p> <p>iPC R2208WFQZS MM# 975890 UPC 00735858344753 EAN 5032037105460 MOQ 1</p>	<p>Product type L6 integrated system Chassis form factor 2U rack mount Packaged gross wt. 22.4 kg (49.2 lb) Un-packaged net wt. 15.8 kg (34.7 lb) Chassis dimensions 712 x 439 x 89 mm (L x W x H) Package dimensions 983 x 577 x 260 mm (L x W x H)</p>
Included	Required Items (sold separately)	Optional Accessories (sold separately)
<p>(1) – 2U Chassis with Quick Reference Label affixed to top cover (1) – Intel® Server Board S2600WFQ (Intel® QAT support) – iPC S2600WFQ (2) – PCIe* riser card brackets. Includes: o (2) 3-slot PCIe* riser cards – iPC A2UL8RISER2 o (1) 2-slot low profile PCIe* riser card – iPC A2UX8X4RISER (8) – 2.5" hot-swap drive bays with drive carriers and blanks. Includes: o (1) SAS/NVMe* combo backplane – iPC F2U8X25S3PHS o (8) 2.5" hot-swap drive tool less carriers – iPC FXX25HSCAR3 (1) – Standard control panel assembly (board only – iPC FXXFPANEL2) o 300 mm front panel cable – iPN H34381-xxx o (1) – Front I/O panel assembly (1 x VGA and 2 x USB) o 620 mm USB 3.0 cable – iPN H76899-xxx o 400 mm video cable – iPN H62114-xxx (1) – 250 mm backplane I2C cable – iPN H91166-xxx (1) – 290 mm Intel® QAT cable – iPN J61138-xxx (1) – 400/525/675 mm backplane power cable – iPN H82108-XXX (1) – Standard 2U air duct – iPN H90554-xxx (6) – Hot swap system fans – iPC FR2UFAN60HSW (8) – DIMM slot blanks – iPN G75158-00x (1) – 1300W AC power supply module – iPC AXX1300TCRPS (1) – Power supply bay blank insert (2) – AC power cord retention strap assembly – iPN H23961-00x (2) – CPU heat sinks – iPC FXXCA78X108HS (2) – CPU heat sink "NO CPU" Mylar* spacer insert – iPN J16115-XXX (2) – Standard CPU carrier – iPN H72851-xxx (1) – 3x Intel® RAID Maintenance Free Backup unit mounting bracket – iPN H18238-00x (1) – 250 mm fixed mount SSD power cable – iPN J29245-xxx Spares for each screw type included</p>	<ul style="list-style-type: none"> • Power cord(s) – See Section 5.6 • Rack mount kit – See Section 5.7 • (1) or (2) 1st or 2nd Intel® Xeon® processor Scalable family (support for 2nd Gen Intel® Xeon® processor Scalable family requires a system software stack update from http://downloadcenter.intel.com) • ECC DDR4 memory (RDIMM or LRDIMM) 	<p>Note: 4-port mini-SAS HD connectors are present on S2600WFQ but are not configured as SATA; these cables are used only for Intel® QAT. An add-in SAS card or module is needed to support SATA/SAS front devices.</p> <ul style="list-style-type: none"> • Second 1300W AC power supply module to support power redundancy – iPC AXX1300TCRPS • Intel® Ethernet Network Adapter for OCP* – See Chapter 5.4 for available options • Intel® 12G SAS RAID module and Intel® RAID Maintenance Free Backup unit – See Chapter 5.5 for available options • SAS data cables – Depending on the location of the SAS data controller, new data cables may be necessary. See Chapter 4. • PCIe* OCuLink data cables (1 per NVMe* drive) – See Chapter 4 • 8 x 2.5" drive bay module upgrade kit – See Section 4.7 for available options • SATA upgrade key for Intel® Embedded Server Technology 2 RAID 5 support – iPC RKSATA4R5 • Rear mount hot-swap drive bay accessory kit – iPC A2UREARHSDK2 • Storage drives <p>See Chapters 5 and 6 for all available accessory options.</p>

Table 32. Intel® Server System R2208WFQZSR product specifications and configuration requirements


Intel® Server System R2208WFQZSR 2U, Intel® Server Board S2600WFQR, 8 x 2.5" SATA/SAS/NVMe* front mount drives			
	iPC R2208WFQZSR MM# 986055 UPC 00735858406901 EAN 5032037151160 MOQ 1	Product type L6 integrated system Chassis form factor 2U rack mount Packaged gross wt. 22.4 kg (49.2 lb) Un-packaged net wt. 15.8 kg (34.7 lb) Chassis dimensions 712 x 439 x 89 mm (L x W x H) Package dimensions 983 x 577 x 260 mm (L x W x H)	
Included	Required Items (sold separately)	Optional Accessories (sold separately)	
<p>(1) – 2U Chassis with Quick Reference Label affixed to top cover</p> <p>(1) – Intel® Server Board S2600WFQR (Intel® QAT support) – iPC S2600WFQR</p> <p>(2) – PCIe* riser card brackets. Includes:</p> <ul style="list-style-type: none"> o (2) 3-slot PCIe* riser cards – iPC A2UL8RISER2 o (1) 2-slot low profile PCIe* riser card – iPC A2UX8X4RISER <p>(8) – 2.5" hot-swap drive bays with drive carriers and blanks. Includes:</p> <ul style="list-style-type: none"> o (1) SAS/NVMe* combo backplane – iPC F2U8X25S3PHS o (8) 2.5" hot-swap drive tool less carriers – iPC FXX25HSCAR3 <p>(1) – Standard control panel assembly (board only – iPC FXXFPANEL2)</p> <ul style="list-style-type: none"> o 300 mm front panel cable – iPN H34381-xxx <p>(1) – Front I/O panel assembly (1 x VGA and 2 x USB)</p> <ul style="list-style-type: none"> o 620 mm USB 3.0 cable – iPN H76899-xxx o 400 mm video cable – iPN H62114-xxx <p>(1) – 250 mm backplane I2C cable – iPN H91166-xxx</p> <p>(1) – 290 mm Intel® QAT cable – iPN J61138-xxx</p> <p>(1) – 400/525/675 mm backplane power cable – iPN H82108-XXX</p> <p>(1) – Standard 2U air duct – iPN H90554-xxx</p> <p>(6) – Hot swap system fans – iPC FR2UFAN60HSW</p> <p>(8) – DIMM slot blanks – iPN G75158-00x</p> <p>(1) – 1300W AC power supply module – iPC AXX1300TCRPS</p> <p>(1) – Power supply bay blank insert</p> <p>(2) – AC power cord retention strap assembly – iPN H23961-00x</p> <p>(2) – CPU heat sinks – iPC FXXCA78X108HS</p> <p>(2) – CPU heat sink "NO CPU" Mylar* spacer insert – iPN J16115-XXX</p> <p>(2) – Standard CPU carrier – iPN H72851-xxx</p> <p>(1) – 3x Intel® RAID Maintenance Free Backup unit mounting bracket – iPN H18238-00x</p> <p>(1) – 250 mm fixed mount SSD power cable – iPN J29245-xxx</p> <p>Spares for each screw type included</p>	<ul style="list-style-type: none"> • Power cord(s) – See Section 5.6 • Rack mount kit – See Section 5.7 • (1) or (2) 1st or 2nd Intel® Xeon® processor Scalable family • ECC DDR4 memory (RDIMM or LRDIMM) 	<p>Note: 4-port mini-SAS HD connectors are present on S2600WFQ but are not configured as SATA; these cables are used only for Intel® QAT. An add-in SAS card or module is needed to support SATA/SAS front devices.</p> <ul style="list-style-type: none"> • Second 1300W AC power supply module to support power redundancy – iPC AXX1300TCRPS • Intel® Ethernet Network Adapter for OCP* – See Chapter 5.4 for available options • Intel® 12G SAS RAID module and Intel® RAID Maintenance Free Backup unit – See Chapter 5.5 for available options • SAS data cables – Depending on the location of the SAS data controller, new data cables may be necessary. See Chapter 4. • PCIe* OCuLink data cables (1 per NVMe* drive) – See Chapter 4 • 8 x 2.5" drive bay module upgrade kit – See Section 4.7 for available options • SATA upgrade key for Intel® Embedded Server Technology 2 RAID 5 support – iPC RKSATA4R5 • Rear mount hot-swap drive bay accessory kit – iPC A2UREARHSDK2 • Storage drives • DDR4-compatible Intel® Optane™ DC persistent memory module (requires an installed 2nd Gen Intel® Xeon® Scalable processor) <p>See Chapters 5 and 6 for all available accessory options.</p>	

Table 33. Intel® Server System LFRB2208WTF801 product specifications and configuration requirements

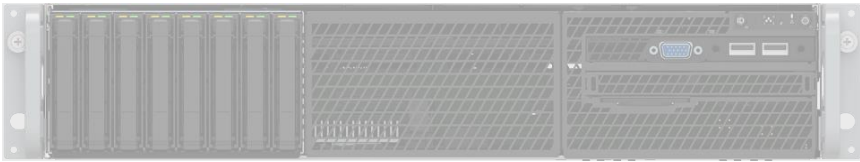
Intel® Server System LFRB2208WTF801 2U, Intel® Server Board S2600WTF, 8 x 2.5" SATA/SAS/NVMe* front mount drives, Intel® Xeon® Platinum 8160H processor		
	<p>This part is no longer available to order. See PCN 116985-00 for more details.</p> <p>iPC LFRB2208WTF801 MM# 974987 UPC 00735858388757 EAN 5032037137300 MOQ 1</p>	<p>Product type L9 integrated system Chassis form factor 2U rack mount Packaged gross wt. 22.8 kg (50.2 lb) Un-packaged net wt. 16.7 kg (36.2 lb) Chassis dimensions 712 x 439 x 89 mm (L x W x H) Package dimensions 983 x 577 x 260 mm (L x W x H)</p>
Included	Required Items (sold separately)	Optional Accessories (sold separately)
<ul style="list-style-type: none"> (1) – 2U Chassis with Quick Reference Label affixed to top cover (1) – Intel® Server Board S2600WTF (dual 10GbE LAN) – iPC S2600WTF (2) – Intel® Xeon® Platinum 8160H processor (2) – 16 GB, RDIMM, DDR4, 2666 memory module – iPN J26609-002 (1) – Intel® Remote Management Module 4 Lite 2 – iPC AXXRMM4LITE2 (2) – PCIe* riser card brackets. Includes: <ul style="list-style-type: none"> o (2) 3-slot PCIe* riser cards – iPC A2UL8RISER2 o (1) 2-slot low profile PCIe* riser card – iPC A2UX8X4RISER (8) – 2.5" hot-swap drive bays with drive carriers and blanks. Includes: <ul style="list-style-type: none"> o (1) SAS/NVMe* combo backplane – iPC F2U8X25S3PHS o (8) 2.5" hot-swap drive tool less carriers – iPC FXX25HSCAR3 (1) – Standard control panel assembly (board only – iPC FXXFPANEL2) <ul style="list-style-type: none"> o 300 mm front panel cable – iPN H34381-xxx (1) – Front I/O panel assembly (1 x VGA and 2 x USB) <ul style="list-style-type: none"> o 620 mm USB 3.0 cable – iPN H76899-xxx o 400 mm video cable – iPN H62114-xxx (1) – RFID antenna – iPN H69566-xxx (1) – 250 mm backplane I2C cable – iPN H91166-xxx (2) – 730 mm mini SAS HD cable – iPC AXXCBL730HDHD (1) – 400/525/675 mm backplane power cable – iPN H82108-XXX (1) – Standard 2U air duct – iPN H90554-xxx (6) – Hot-swap system fans – iPC FR2UFAN60HSW (8) – DIMM slot blanks – iPN G75158-00x (2) – 1300W AC power supply module – iPC AXX1300TCRPS (2) – AC power cord retention strap assembly – iPN H23961-00x (2) – CPU heat sinks – iPC FXXCA78X108HS (2) – Standard CPU carrier – iPN H72851-xxx (1) – 3x Intel® RAID Maintenance Free Backup unit mounting bracket – iPN H18238-00x (1) – 250 mm fixed mount SSD power cable – iPN J29245-xxx <p>Spares for each screw type included</p>	<ul style="list-style-type: none"> • Power cord(s) – See Section 5.6 • Rack mount kit – See Section 5.7 	<p>Note: By default the front drive bays are cabled to onboard SATA only ports. An add-in SAS card or module is needed to support SAS devices.</p> <ul style="list-style-type: none"> • Intel® Ethernet Network Adapter for OCP* – See Chapter 5.4 for available options • Intel® 12G SAS RAID module and Intel® RAID Maintenance Free Backup unit – See Chapter 5.5 for available options • SAS data cables – Depending on the location of the SAS data controller, new data cables may be necessary. See Chapter 4. • PCIe* OCuLink data cables (1 per NVMe* drive) – See Chapter 4 • 8 x 2.5" drive bay module upgrade kit – See Section 4.7 for available options • SATA upgrade key for Intel® Embedded Server Technology 2 RAID 5 support – iPC RKSATA4R5 • Rear mount hot-swap drive bay accessory kit – iPC A2UREARHSDK2 • ECC DDR4 memory (RDIMM or LRDIMM) • Storage drives <p>See Chapters 5 and 6 for all available accessory options.</p>

Table 34. Intel® Server System LFRB2208WTF601 product specifications and configuration requirements

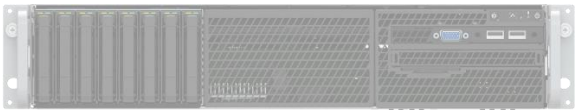
Intel® Server System LFRB2208WTF601 2U, Intel® Server Board S2600WTF, 8 x 2.5" SATA/SAS/NVMe* front mount drives, Intel® Xeon® Gold 6130H processor		
	<p>This part is no longer available to order. See PCN 116985-00 for more details.</p> <p>iPC LFRB2208WTF601 MM# 982901 UPC 00735858387514 EAN 5032037136389 MOQ 1</p>	<p>Product type L9 integrated system Chassis form factor 2U rack mount Packaged gross wt. 22.8 kg (50.2 lb) Un-packaged net wt. 16.7 kg (36.2 lb) Chassis dimensions 712 x 439 x 89 mm (L x W x H) Package dimensions 983 x 577 x 260 mm (L x W x H)</p>
Included	Required Items (sold separately)	Optional Accessories (sold separately)
<p>(1) – 2U Chassis with Quick Reference Label affixed to top cover (1) – Intel® Server Board S2600WTF (dual 10GbE LAN) – iPC S2600WTF (2) – Intel® Xeon® Gold 6130H processor (2) – 16 GB, RDIMM, DDR4, 2666 memory module – iPN J26609-002 (1) – Intel® Remote Management Module 4 Lite 2 – iPC AXXRMM4LITE2 (2) – PCIe* riser card brackets. Includes: o (2) 3-slot PCIe* riser cards – iPC A2UL8RISER2 o (1) 2-slot low profile PCIe* riser card – iPC A2UX8X4RISER (8) – 2.5" hot-swap drive bays with drive carriers and blanks. Includes: o (1) SAS/NVMe* combo backplane – iPC F2U8X25S3PHS o (8) 2.5" hot-swap drive tool less carriers – iPC FXX25HSCAR3 (1) – Standard control panel assembly (board only – iPC FXXFPANEL2) o 300 mm front panel cable – iPN H34381-xxx (1) – Front I/O panel assembly (1 x VGA and 2 x USB) o 620 mm USB 3.0 cable – iPN H76899-xxx o 400 mm video cable – iPN H62114-xxx (1) – RFID antenna – iPN H69566-xxx (1) – 250 mm backplane I2C cable – iPN H91166-xxx (2) – 730 mm mini SAS HD cable – iPC AXXCBL730HDHD (1) – 400/525/675 mm backplane power cable – iPN H82108-XXX (1) – Standard 2U air duct – iPN H90554-xxx (6) – Hot-swap system fans – iPC FR2UFAN60HSW (8) – DIMM slot blanks – iPN G75158-00x (2) – 1300W AC power supply module – iPC AXX1300TCRPS (2) – AC power cord retention strap assembly – iPN H23961-00x (2) – CPU heat sinks – iPC FXXCA78X108HS (2) – Standard CPU carrier – iPN H72851-xxx (1) – 3x Intel® RAID Maintenance Free Backup unit mounting bracket – iPN H18238-00x (1) – 250 mm fixed mount SSD power cable – iPN J29245-xxx Spares for each screw type included</p>	<ul style="list-style-type: none"> • Power cord(s) – See Section 5.6 • Rack mount kit – See Section 5.7 	<p>Note: By default the front drive bays are cabled to onboard SATA only ports. An add-in SAS card or module is needed to support SAS devices.</p> <ul style="list-style-type: none"> • Intel® Ethernet Network Adapter for OCP* – See Chapter 5.4 for available options • Intel® 12G SAS RAID module and Intel® RAID Maintenance Free Backup unit – See Chapter 5.5 for available options • SAS data cables – Depending on the location of the SAS data controller, new data cables may be necessary. See Chapter 4. • PCIe* OCuLink data cables (1 per NVMe* drive) – See Chapter 4 • 8 x 2.5" drive bay module upgrade kit – See Section 4.7 for available options • SATA upgrade key for Intel® Embedded Server Technology 2 RAID 5 support – iPC RKSATA4R5 • Rear mount hot-swap drive bay accessory kit – iPC A2UREARHSDK2 • ECC DDR4 memory (RDIMM or LRDIMM) • Storage drives <p>See Chapters 5 and 6 for all available accessory options.</p>

Table 35. Intel® Server System LFRB2208WTF401 product specifications and configuration requirements

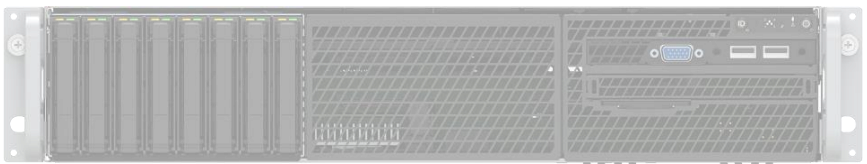
Intel® Server System LFRB2208WTF401 2U, Intel® Server Board S2600WTF, 8 x 2.5" SATA/SAS/NVMe* front mount drives, Intel® Xeon® Silver 4106H processor		
	<p>This part is no longer available to order. See PCN 116985-00 for more details.</p> <p>iPC LFRB2208WTF401 MM# 974993 UPC 00735858388764 EAN 5032037137317 MOQ 1</p>	<p>Product type L9 integrated system Chassis form factor 2U rack mount Packaged gross wt. 22.8 kg (50.2 lb) Un-packaged net wt. 16.7 kg (36.2 lb) Chassis dimensions 712 x 439 x 89 mm (L x W x H) Package dimensions 983 x 577 x 260 mm (L x W x H)</p>
Included	Required Items (sold separately)	Optional Accessories (sold separately)
<p>(1) – 2U Chassis with Quick Reference Label affixed to top cover (1) – Intel® Server Board S2600WTF (dual 10GbE LAN) – iPC S2600WTF (2) – Intel® Xeon® Silver 4106H processor (2) – 16 GB, RDIMM, DDR4, 2666 memory module – iPN J26609-002 (1) – Intel® Remote Management Module 4 Lite 2 – iPC AXXRMM4LITE2 (2) – PCIe* riser card brackets. Includes: o (2) 3-slot PCIe* riser cards – iPC A2UL8RISER2 o (1) 2-slot low profile PCIe* riser card – iPC A2UX8X4RISER (8) – 2.5" hot-swap drive bays with drive carriers and blanks. Includes: o (1) SAS/NVMe* combo backplane – iPC F2U8X25S3PHS o (8) 2.5" hot-swap drive tool less carriers – iPC FXX25HSCAR3 (1) – Standard control panel assembly (board only – iPC FXXFPANEL2) o 300 mm front panel cable – iPN H34381-xxx (1) – Front I/O panel assembly (1 x VGA and 2 x USB) o 620 mm USB 3.0 cable – iPN H76899-xxx o 400 mm video cable – iPN H62114-xxx (1) – RFID antenna – iPN H69566-xxx (1) – 250 mm backplane I2C cable – iPN H91166-xxx (2) – 730 mm mini SAS HD cable – iPC AXXCBL730HDHD (1) – 400/525/675 mm backplane power cable – iPN H82108-XXX (1) – Standard 2U air duct – iPN H90554-xxx (6) – Hot-swap system fans – iPC FR2UFAN60HSW (8) – DIMM slot blanks – iPN G75158-00x (2) – 1300W AC power supply module – iPC AXX1300TCRPS (2) – AC power cord retention strap assembly – iPN H23961-00x (2) – CPU heat sinks – iPC FXXCA78X108HS (2) – Standard CPU carrier – iPN H72851-xxx (1) – 3x Intel® RAID Maintenance Free Backup unit mounting bracket – iPN H18238-00x (1) – 250 mm fixed mount SSD power cable – iPN J29245-xxx Spares for each screw type included</p>	<ul style="list-style-type: none"> • Power cord(s) – See Section 5.6 • Rack mount kit – See Section 5.7 	<p>Note: By default the front drive bays are cabled to onboard SATA only ports. An add-in SAS card or module is needed to support SAS devices.</p> <ul style="list-style-type: none"> • Intel® Ethernet Network Adapter for OCP* – See Chapter 5.4 for available options • Intel® 12G SAS RAID module and Intel® RAID Maintenance Free Backup unit – See Chapter 5.5 for available options • SAS data cables – Depending on the location of the SAS data controller, new data cables may be necessary. See Chapter 4. • PCIe* OCuLink data cables (1 per NVMe* drive) – See Chapter 4 • 8 x 2.5" drive bay module upgrade kit – See Section 4.7 for available options • SATA upgrade key for Intel® Embedded Server Technology 2 RAID 5 support – iPC RKSATA4R5 • Rear mount hot-swap drive bay accessory kit – iPC A2UREARHSDK2 • ECC DDR4 memory (RDIMM or LRDIMM) • Storage drives <p>See Chapters 5 and 6 for all available accessory options.</p>

Table 36. Intel® Server System R2312WF0NP product specifications and configuration requirements


Intel® Server System R2312WF0NP 2U, Intel® Server Board S2600WF0, 12 x 3.5" HDD or 12 x 2.5" SATA/SAS front mount drives (support for up to 2 NVMe* drives)		
	<p>This part is no longer available to order, refer to replacement part MM# 986054. See PCN116894-02 for more details.</p> <p>iPC R2312WF0NP MM# 975812 UPC 00735858344821 EAN 5032037105538 MOQ 1</p>	<p>Product type L6 integrated system Chassis form factor 2U rack mount Packaged gross wt. 23.4 kg (51.5 lb) Un-packaged net wt. 16.9 kg (37.1 lb) Chassis dimensions 712 x 439 x 89 mm (L x W x H) Package dimensions 983 x 577 x 260 mm (L x W x H)</p>
Included	Required Items (sold separately)	Optional Accessories (sold separately)
<p>(1) – 2U Chassis with Quick Reference Label affixed to top cover (1) – Intel® Server Board S2600WF0 (no onboard LAN) – iPC S2600WF0 (2) – PCIe* riser card brackets. Includes: o (2) 3-slot PCIe* riser cards – iPC A2UL8RISER2 o (1) 2-slot low profile PCIe* riser card – iPC A2UX8X4RISER (12) – 3.5" hot-swap drive bays with drive carriers and blanks. Includes: o (1) SAS/NVMe* combo backplane – iPC F2U12X35S3PH o (12) 3.5" hot-swap drive tool less carriers – iPC FXX35HSCAR3 (1) – Storage rack handle assembly – iPC A2UHANDLKIT o 1 set storage rack handles o Mini front panel (board only – iPN G28538-xxx) o 410 mm front panel cable – iPN H26893-xxx o 640 mm front panel USB 2.0 cable iPN H20005-xxx (1) – 175 mm Backplane I2C cable – iPN H91172-xxx (1) – 800 mm Mini SAS HD cable – iPC AXXCBL800HDHD (1) – 875 mm mini SAS HD cable – iPC AXXCBL875HDHD (1) – 950 mm mini SAS HD cable – iPC AXXCBL950HDHD (1) – 525/675 mm backplane power cable – iPN H82097-xxx (1) – Standard 2U air duct – iPN H90554-xxx (6) – Hot-swap system fans – iPC FR2UFAN60HSW (16) – DIMM slot blanks – iPN G75158-00x (1) – Power supply bay blank insert (2) – AC power cord retention strap assembly – iPN H23961-00x (2) – CPU heat sinks – iPC FXXCA78X108HS (2) – CPU heat sink "NO CPU" Mylar* spacer insert – iPN J16115-XXX (2) – Standard CPU carrier – iPN H72851-xxx (2) – Chassis handle (1 set) installed – iPN H18229-xxx (1) – 3x Intel® RAID Maintenance Free Backup unit mounting bracket – iPN H18238-00x (1) – 250 mm fixed mount SSD power cable – iPN J29245-xxx Spares for each screw type included</p>	<ul style="list-style-type: none"> • Power supply module(s) (choose one type) – (2) common modules required for redundancy <ul style="list-style-type: none"> o 1300W AC power supply module – iPC AXX1300TCRPS o 1100W AC power supply module – iPC AXX1100PCRPS o 750 W DC power supply module – iPC AXX750DCCRPS • Power cord(s) – See Section 5.6 • Rack mount kit – See Section 5.7 • (1) or (2) 1st or 2nd Intel® Xeon® processor Scalable family (support for 2nd Gen Intel® Xeon® processor Scalable family requires a system software stack update from http://downloadcenter.intel.com) • ECC DDR4 memory (RDIMM or LRDIMM) 	<p>Note: By default the front drive bays are cabled to onboard SATA only ports. An add-in SAS card or module is needed to support SAS devices.</p> <ul style="list-style-type: none"> • Intel® Ethernet Network Adapter for OCP* – See Chapter 5.4 for available options • Intel® 12G SAS RAID module and Intel® RAID Maintenance Free Backup unit – See Chapter 5.5 for available options • SAS data cables – Depending on the location of the SAS data controller, new data cables may be necessary. See Chapter 4. • PCIe* OCuLink data cables (1 per NVMe* drive) – See Chapter 4 • SATA upgrade key for Intel® Embedded Server Technology 2 RAID 5 support – iPC RKSATA4R5 • Rear mount hot-swap drive bay accessory kit – iPC A2UREARHSDK2 • Storage drives <p>See Chapters 5 and 6 for all available accessory options.</p>

Table 37. Intel® Server System R2312WF0NPR product specifications and configuration requirements


Intel® Server System R2312WF0NPR			
2U, Intel® Server Board S2600WF0R, 12 x 3.5" HDD or 12 x 2.5" SATA/SAS front mount drives (support for up to 2 NVMe* drives)			
		iPC R2312WF0NPR MM# 986054 UPC 00735858406895 EAN 5032037151153 MOQ 1	Product type L6 integrated system Chassis form factor 2U rack mount Packaged gross wt. 23.4 kg (51.5 lb) Un-packaged net wt. 16.9 kg (37.1 lb) Chassis dimensions 712 x 439 x 89 mm (L x W x H) Package dimensions 983 x 577 x 260 mm (L x W x H)
Included	Required Items (sold separately)	Optional Accessories (sold separately)	
<p>(1) – 2U Chassis with Quick Reference Label affixed to top cover</p> <p>(1) – Intel® Server Board S2600WF0R (no onboard LAN) – iPC S2600WF0R</p> <p>(2) – PCIe* riser card brackets. Includes:</p> <ul style="list-style-type: none"> o (2) 3-slot PCIe* riser cards – iPC A2UL8RISER2 o (1) 2-slot low profile PCIe* riser card – iPC A2UX8X4RISER <p>(12) – 3.5" hot-swap drive bays with drive carriers and blanks. Includes:</p> <ul style="list-style-type: none"> o (1) SAS/NVMe* combo backplane – iPC F2U12X35S3PH o (12) 3.5" hot-swap drive tool less carriers – iPC FXX35HSCAR3 <p>(1) – Storage rack handle assembly – iPC A2UHANDLKIT</p> <ul style="list-style-type: none"> o 1 set storage rack handles o Mini front panel (board only – iPN G28538-xxx) o 410 mm front panel cable – iPN H26893-xxx o 640 mm front panel USB 2.0 cable iPN H20005-xxx <p>(1) – 175 mm Backplane I2C cable – iPN H91172-xxx</p> <p>(1) – 800 mm Mini SAS HD cable – iPC AXXCBL800HDHD</p> <p>(1) – 875 mm mini SAS HD cable – iPC AXXCBL875HDHD</p> <p>(1) – 950 mm mini SAS HD cable – iPC AXXCBL950HDHD</p> <p>(1) – 525/675 mm backplane power cable – iPN H82097-xxx</p> <p>(1) – Standard 2U air duct – iPN H90554-xxx</p> <p>(6) – Hot-swap system fans – iPC FR2UFAN60HSW</p> <p>(16) – DIMM slot blanks – iPN G75158-00x</p> <p>(1) – Power supply bay blank insert</p> <p>(2) – AC power cord retention strap assembly – iPN H23961-00x</p> <p>(2) – CPU heat sinks – iPC FXXCA78X108HS</p> <p>(2) – CPU heat sink "NO CPU" Mylar* spacer insert – iPN J16115-XXX</p> <p>(2) – Standard CPU carrier – iPN H72851-xxx</p> <p>(2) – Chassis handle (1 set) installed – iPN H18229-xxx</p> <p>(1) – 3x Intel® RAID Maintenance Free Backup unit mounting bracket – iPN H18238-00x</p> <p>(1) – 250 mm fixed mount SSD power cable – iPN J29245-xxx</p> <p>Spares for each screw type included</p>	<ul style="list-style-type: none"> • Power supply module(s) (choose one type) – (2) common modules required for redundancy <ul style="list-style-type: none"> o 1300W AC power supply module – iPC AXX1300TCRPS o 1100W AC power supply module – iPC AXX1100PCRPS o 750 W DC power supply module – iPC AXX750DCCRPS • Power cord(s) – See Section 5.6 • Rack mount kit – See Section 5.7 • (1) or (2) 1st or 2nd Intel® Xeon® processor Scalable family • ECC DDR4 memory (RDIMM or LRDIMM) 	<p>Note: By default the front drive bays are cabled to onboard SATA only ports. An add-in SAS card or module is needed to support SAS devices.</p> <ul style="list-style-type: none"> • Intel® Ethernet Network Adapter for OCP* – See Chapter 5.4 for available options • Intel® 12G SAS RAID module and Intel® RAID Maintenance Free Backup unit – See Chapter 5.5 for available options • SAS data cables – Depending on the location of the SAS data controller, new data cables may be necessary. See Chapter 4. • PCIe* OCuLink data cables (1 per NVMe* drive) – See Chapter 4 • SATA upgrade key for Intel® Embedded Server Technology 2 RAID 5 support – iPC RKSATA4R5 • Rear mount hot-swap drive bay accessory kit – iPC A2UREARHSDK2 • Storage drives • DDR4-compatible Intel® Optane™ DC persistent memory module (requires an installed 2nd Gen Intel® Xeon® Scalable processor) <p>See Chapters 5 and 6 for all available accessory options.</p>	

Table 38. Intel® Server System R2312WFTZS product specifications and configuration requirements


Intel® Server System R2312WFTZS 2U, Intel® Server Board S2600WFT, 12 x 3.5" HDD or 12 x 2.5" SSD SATA/SAS front mount drives (support for up to 2 NVMe* drives)		
	<p>This part is no longer available to order, refer to replacement part MM# 986053. See PCN116894-02 for more details.</p> <p>iPC R2312WFTZS MM# 975892 UPC 00735858344791 EAN 5032037105507 MOQ 1</p>	<p>Product type L6 integrated system Chassis form factor 2U rack mount Packaged gross wt. 23.4 kg (51.5 lb) Un-packaged net wt. 16.9 kg (37.1 lb) Chassis dimensions 712 x 439 x 89 mm (L x W x H) Package dimensions 983 x 577 x 260 mm (L x W x H)</p>
Included	Required Items (sold separately)	Optional Accessories (sold separately)
<p>(1) – 2U Chassis with Quick Reference Label affixed to top cover (1) – Intel® Server Board S2600WFT (dual 10 GbE LAN) – iPC S2600WFT (2) – PCIe* riser card brackets. Includes: o (2) 3-slot PCIe* riser cards – iPC A2UL8RISER2 o (1) 2-slot low profile PCIe* riser card – iPC A2UX8X4RISER (12) – 3.5" hot-swap drive bays with drive carriers and blanks. Includes: o (1) SAS/NVMe* combo backplane – iPC F2U12X35S3PH o (12) 3.5" hot-swap drive tool less carriers – iPC FXX35HSCAR2 (1) – Storage rack handle assembly – iPC A2UHANDLKIT o 1 set storage rack handles o Mini front panel (board only – iPN G28538-xxx) o 410 mm front panel cable – iPN H26893-xxx o 640 mm front panel USB 2.0 cable iPN H20005-xxx (1) – 175 mm backplane I2C Cable – iPN H91172-xxx (1) – 800 mm mini SAS HD cable – iPC AXXCBL800HDHD (1) – 875 mm mini SAS HD cable – iPC AXXCBL875HDHD (1) – 950 mm mini SAS HD cable – iPC AXXCBL950HDHD (1) – 525/675 mm backplane power cable – iPN H82097-xxx (1) – Standard 2U air duct – iPN H90554-xxx (6) – Hot-swap system fans – iPC FR2UFAN60HSW (16) – DIMM slot blanks – iPN G75158-00x (1) – 1300W AC power supply module – iPC AXX1300TCRPS (1) – Power supply bay blank insert (2) – AC power cord retention strap assembly – iPN H23961-00x (2) – CPU heat sinks – iPC FXXCA78X108HS (2) – CPU heat sink "NO CPU" Mylar* spacer insert – iPN J16115-XXX (2) – Standard CPU carrier – iPN H72851-xxx (2) – Chassis handle (1 set) installed – iPN H18229-xxx (1) – 3x Intel® RAID Maintenance Free Backup unit mounting bracket – iPN H18238-00x (1) – 250 mm fixed mount SSD power cable – iPN J29245-xxx Spares for each screw type included</p>	<ul style="list-style-type: none"> • Power cord(s) – See Section 5.6 • Rack mount kit – See Section 5.7 • (1) or (2) 1st or 2nd Gen Intel® Xeon® processor Scalable family (support for 2nd Gen Intel® Xeon® processor Scalable family requires a system software stack update from http://downloadcenter.intel.com) • ECC DDR4 memory (RDIMM or LRDIMM) 	<p>Note: By default the front drive bays are cabled to onboard SATA only ports. An add-in SAS card or module is needed to support SAS devices.</p> <ul style="list-style-type: none"> • Second 1300W AC power supply module to support power redundancy – iPC AXX1300TCRPS • Intel® Ethernet Network Adapter for OCP* – See Chapter 5.4 for available options • Intel® 12G SAS RAID module and Intel® RAID Maintenance Free Backup unit – See Chapter 5.5 for available options • SAS data cables – Depending on the location of the SAS data controller, new data cables may be necessary. See Chapter 4. • PCIe* OCuLink data cables (1 per NVMe* drive) – See Chapter 4 • SATA upgrade key for Intel® Embedded Server Technology 2 RAID 5 support – iPC RKSATA4R5 • Rear mount hot-swap drive bay accessory kit – iPC A2UREARHSDK2 • Storage drives <p>See Chapters 5 and 6 for all available accessory options.</p>

Table 39. Intel® Server System R2312WFTZSR product specifications and configuration requirements


Intel® Server System R2312WFTZSR			
2U, Intel® Server Board S2600WFTR, 12 x 3.5" HDD or 12 x 2.5" SSD SATA/SAS front mount drives (support for up to 2 NVMe* drives)			
	iPC R2312WFTZSR MM# 986053 UPC 00735858406888 EAN 5032037151146 MOQ 1	Product type L6 integrated system Chassis form factor 2U rack mount Packaged gross wt. 23.4 kg (51.5 lb) Un-packaged net wt. 16.9 kg (37.1 lb) Chassis dimensions 712 x 439 x 89 mm (L x W x H) Package dimensions 983 x 577 x 260 mm (L x W x H)	
Included	Required Items (sold separately)	Optional Accessories (sold separately)	
<p>(1) – 2U Chassis with Quick Reference Label affixed to top cover</p> <p>(1) – Intel® Server Board S2600WFTR (dual 10 GbE LAN) – iPC S2600WFTR</p> <p>(2) – PCIe* riser card brackets. Includes:</p> <ul style="list-style-type: none"> o (2) 3-slot PCIe* riser cards – iPC A2UL8RISER2 o (1) 2-slot low profile PCIe* riser card – iPC A2UX8X4RISER <p>(12) – 3.5" hot-swap drive bays with drive carriers and blanks. Includes:</p> <ul style="list-style-type: none"> o (1) SAS/NVMe* combo backplane – iPC F2U12X35S3PH o (12) 3.5" hot-swap drive tool less carriers – iPC FXX35HSCAR2 <p>(1) – Storage rack handle assembly – iPC A2UHANDLKIT</p> <ul style="list-style-type: none"> o 1 set storage rack handles o Mini front panel (board only – iPN G28538-xxx) o 410 mm front panel cable – iPN H26893-xxx o 640 mm front panel USB 2.0 cable iPN H20005-xxx <p>(1) – 175 mm backplane I2C Cable – iPN H91172-xxx</p> <p>(1) – 800 mm mini SAS HD cable – iPC AXXCBL800HDHD</p> <p>(1) – 875 mm mini SAS HD cable – iPC AXXCBL875HDHD</p> <p>(1) – 950 mm mini SAS HD cable – iPC AXXCBL950HDHD</p> <p>(1) – 525/675 mm backplane power cable – iPN H82097-xxx</p> <p>(1) – Standard 2U air duct – iPN H90554-xxx</p> <p>(6) – Hot-swap system fans – iPC FR2UFAN60HSW</p> <p>(16) – DIMM slot blanks – iPN G75158-00x</p> <p>(1) – 1300W AC power supply module – iPC AXX1300TCRPS</p> <p>(1) – Power supply bay blank insert</p> <p>(2) – AC power cord retention strap assembly – iPN H23961-00x</p> <p>(2) – CPU heat sinks – iPC FXXCA78X108HS</p> <p>(2) – CPU heat sink "NO CPU" Mylar* spacer insert – iPN J16115-XXX</p> <p>(2) – Standard CPU carrier – iPN H72851-xxx</p> <p>(2) – Chassis handle (1 set) installed – iPN H18229-xxx</p> <p>(1) – 3x Intel® RAID Maintenance Free Backup unit mounting bracket – iPN H18238-00x</p> <p>(1) – 250 mm fixed mount SSD power cable – iPN J29245-xxx</p> <p>Spares for each screw type included</p>	<ul style="list-style-type: none"> • Power cord(s) – See Section 5.6 • Rack mount kit – See Section 5.7 • (1) or (2) 1st or 2nd Gen Intel® Xeon® processor Scalable family • ECC DDR4 memory (RDIMM or LRDIMM) 	<p>Note: By default the front drive bays are cabled to onboard SATA only ports. An add-in SAS card or module is needed to support SAS devices.</p> <ul style="list-style-type: none"> • Second 1300W AC power supply module to support power redundancy – iPC AXX1300TCRPS • Intel® Ethernet Network Adapter for OCP* – See Chapter 5.4 for available options • Intel® 12G SAS RAID module and Intel® RAID Maintenance Free Backup unit – See Chapter 5.5 for available options • SAS data cables – Depending on the location of the SAS data controller, new data cables may be necessary. See Chapter 4. • PCIe* OCuLink data cables (1 per NVMe* drive) – See Chapter 4 • SATA upgrade key for Intel® Embedded Server Technology 2 RAID 5 support – iPC RKSATA4R5 • Rear mount hot-swap drive bay accessory kit – iPC A2UREARHSDK2 • Storage drives • DDR4-compatible Intel® Optane™ DC persistent memory module (requires an installed 2nd Gen Intel® Xeon® Scalable processor) <p>See Chapters 5 and 6 for all available accessory options.</p>	

Table 40. Intel® Server System R2312WFQZS product specifications and configuration requirements


Intel® Server System R2312WFQZS 2U, Intel® Server Board S2600WFQ, 12 x 3.5" HDD or 12 x 2.5" SSD SATA/SAS front mount drives																								
	<p>This part is no longer available to order, see PCN116894-02 for more details.</p> <table border="0"> <tr> <td>iPC</td> <td>R2312WFQZS</td> </tr> <tr> <td>MM#</td> <td>955877</td> </tr> <tr> <td>UPC</td> <td>00735858344838</td> </tr> <tr> <td>EAN</td> <td>5032037105545</td> </tr> <tr> <td>MOQ</td> <td>1</td> </tr> </table>	iPC	R2312WFQZS	MM#	955877	UPC	00735858344838	EAN	5032037105545	MOQ	1	<table border="0"> <tr> <td>Product type</td> <td>L6 integrated system</td> </tr> <tr> <td>Chassis form factor</td> <td>2U rack mount</td> </tr> <tr> <td>Packaged gross wt.</td> <td>23.4 kg (51.5 lb)</td> </tr> <tr> <td>Un-packaged net wt.</td> <td>16.9 kg (37.1 lb)</td> </tr> <tr> <td>Chassis dimensions</td> <td>712 x 439 x 89 mm (L x W x H)</td> </tr> <tr> <td>Package dimensions</td> <td>983 x 577 x 260 mm (L x W x H)</td> </tr> </table>	Product type	L6 integrated system	Chassis form factor	2U rack mount	Packaged gross wt.	23.4 kg (51.5 lb)	Un-packaged net wt.	16.9 kg (37.1 lb)	Chassis dimensions	712 x 439 x 89 mm (L x W x H)	Package dimensions	983 x 577 x 260 mm (L x W x H)
iPC	R2312WFQZS																							
MM#	955877																							
UPC	00735858344838																							
EAN	5032037105545																							
MOQ	1																							
Product type	L6 integrated system																							
Chassis form factor	2U rack mount																							
Packaged gross wt.	23.4 kg (51.5 lb)																							
Un-packaged net wt.	16.9 kg (37.1 lb)																							
Chassis dimensions	712 x 439 x 89 mm (L x W x H)																							
Package dimensions	983 x 577 x 260 mm (L x W x H)																							
Included	Required Items (sold separately)	Optional Accessories (sold separately)																						
<p>(1) – 2U Chassis with Quick Reference Label affixed to top cover</p> <p>(1) – Intel® Server Board S2600WFQ (Intel® QAT support) – iPC S2600WFQ</p> <p>(2) – PCIe* riser card brackets. Includes:</p> <ul style="list-style-type: none"> o (2) 3-slot PCIe* riser cards – iPC A2UL8RISER2 o (1) 2-slot low profile PCIe* riser card – iPC A2UX8X4RISER <p>(12) – 3.5" hot-swap drive bays with drive carriers and blanks. Includes:</p> <ul style="list-style-type: none"> o (1) SAS/NVMe* combo backplane – iPC F2U12X35S3PH o (12) 3.5" hot-swap drive tool less carriers – iPC FXX35HSCAR2 <p>(1) – Storage rack handle assembly – iPC A2UHANDLKIT</p> <ul style="list-style-type: none"> o 1 set storage rack handles o Mini front panel (board only – iPN G28538-xxx) o 410 mm front panel cable – iPN H26893-xxx o 640 mm front panel USB 2.0 cable iPN H20005-xxx <p>(1) – 175 mm backplane I2C Cable – iPN H91172-xxx</p> <p>(1) – 950 mm mini SAS HD cable – iPC AXXCBL950HDHD</p> <p>(1) – 525/675 mm backplane power cable – iPN H82097-xxx</p> <p>(1) – 290 mm Intel® QAT cable – iPN J61138-xxx</p> <p>(1) – 250 mm fixed mount SSD power cable – iPN J29245-xxx</p> <p>(1) – Standard 2U air duct – iPN H90554-xxx</p> <p>(6) – Hot-swap system fans – iPC FR2UFAN60HSW</p> <p>(16) – DIMM slot blanks – iPN G75158-00x</p> <p>(1) – 1300W AC power supply module – iPC AXX1300TCRPS</p> <p>(1) – Power supply bay blank insert</p> <p>(2) – AC Power cord retention strap assembly – iPN H23961-00x</p> <p>(2) – CPU heat sinks – iPC FXXCA78X108HS</p> <p>(2) – CPU heat sink "NO CPU" Mylar* spacer insert – iPN J16115-XXX</p> <p>(2) – Standard CPU carrier – iPN H72851-xxx</p> <p>(2) – Chassis handle (1 set) installed – iPN H18229-xxx</p> <p>(1) – 3x Intel® RAID Maintenance Free Backup unit mounting bracket – iPN H18238-00x</p> <p>Spares for each screw type included</p>	<ul style="list-style-type: none"> • Power cord(s) – See Section 5.6 • Rack mount kit – See Section 5.7 • (1) or (2) 1st or 2nd Intel® Xeon® processor Scalable family (support for 2nd Gen Intel® Xeon® processor Scalable family requires a system software stack update from http://downloadcenter.intel.com) • ECC DDR4 memory (RDIMM or LRDIMM) 	<p>Note: 4-port mini-SAS HD connectors are present on S2600WFQ but are not configured as SATA; these cables are used only for Intel® QAT. An add-in SAS card or module is needed to support SATA/SAS front devices.</p> <ul style="list-style-type: none"> • Second 1300W AC power supply module to support power redundancy – iPC AXX1300TCRPS • Intel® Ethernet Network Adapter for OCP* – See Chapter 5.4 for available options • Intel® 12G SAS RAID module and Intel® RAID Maintenance Free Backup unit – See Chapter 5.5 for available options • SAS data cables – Depending on the location of the SAS data controller, new data cables may be necessary. See Chapter 4. • SATA upgrade key for Intel® Embedded Server Technology 2 RAID 5 support – iPC RKSATA4R5 • Rear mount hot-swap drive bay accessory kit – iPC A2UREARHSDK2 • Storage drives <p>See Chapters 5 and 6 for all available accessory options.</p>																						

Table 41. Intel® Server System LFRB2312WTF801 product specifications and configuration requirements


Intel® Server System LFRB2312WTF801 2U, Intel® Server Board S2600WTF, 12 x 3.5" HDD or 12 x 2.5" SSD SATA/SAS front mount drives (support for up to 2 NVMe* drives), Intel® Xeon® Platinum 8160H processor																								
	<p>This part is no longer available to order. See PCN 116985-00 for more details.</p> <table border="0"> <tr> <td>iPC</td> <td>LFRB2312WTF801</td> </tr> <tr> <td>MM#</td> <td>982902</td> </tr> <tr> <td>UPC</td> <td>00735858387330</td> </tr> <tr> <td>EAN</td> <td>5032037136242</td> </tr> <tr> <td>MOQ</td> <td>1</td> </tr> </table>	iPC	LFRB2312WTF801	MM#	982902	UPC	00735858387330	EAN	5032037136242	MOQ	1	<table border="0"> <tr> <td>Product type</td> <td>L9 integrated system</td> </tr> <tr> <td>Chassis form factor</td> <td>2U rack mount</td> </tr> <tr> <td>Packaged gross wt.</td> <td>25.0 kg (55.0 lb)</td> </tr> <tr> <td>Un-packaged net wt.</td> <td>17.9 kg (39.5 lb)</td> </tr> <tr> <td>Chassis dimensions</td> <td>712 x 439 x 89 mm (L x W x H)</td> </tr> <tr> <td>Package dimensions</td> <td>983 x 577 x 260 mm (L x W x H)</td> </tr> </table>	Product type	L9 integrated system	Chassis form factor	2U rack mount	Packaged gross wt.	25.0 kg (55.0 lb)	Un-packaged net wt.	17.9 kg (39.5 lb)	Chassis dimensions	712 x 439 x 89 mm (L x W x H)	Package dimensions	983 x 577 x 260 mm (L x W x H)
iPC	LFRB2312WTF801																							
MM#	982902																							
UPC	00735858387330																							
EAN	5032037136242																							
MOQ	1																							
Product type	L9 integrated system																							
Chassis form factor	2U rack mount																							
Packaged gross wt.	25.0 kg (55.0 lb)																							
Un-packaged net wt.	17.9 kg (39.5 lb)																							
Chassis dimensions	712 x 439 x 89 mm (L x W x H)																							
Package dimensions	983 x 577 x 260 mm (L x W x H)																							
Included	Required Items (sold separately)	Optional Accessories (sold separately)																						
<p>(1) – 2U Chassis with Quick Reference Label affixed to top cover</p> <p>(1) – Intel® Server Board S2600WTF (dual 10GbE LAN) – iPC S2600WTF</p> <p>(2) – Intel® Xeon® Platinum 8160H processor</p> <p>(2) – 16 GB, RDIMM, DDR4, 2666 memory module – iPN J26609-002</p> <p>(1) – Intel® Remote Management Module 4 Lite 2 – iPC AXXRMM4LITE2</p> <p>(2) – PCIe* riser card brackets. Includes:</p> <ul style="list-style-type: none"> o (2) 3-slot PCIe* riser cards – iPC A2UL8RISER2 o (1) 2-slot low profile PCIe* riser card – iPC A2UX8X4RISER <p>(12) – 3.5" hot-swap drive bays with drive carriers and blanks. Includes:</p> <ul style="list-style-type: none"> o (1) SAS/NVMe* combo backplane – iPC F2U12X35S3PH o (12) 3.5" hot-swap drive tool less carriers – iPC FXX35HSCAR2 <p>(1) – Storage rack handles set – iPN H98453-001</p> <p>(1) – Mini front panel (board only – iPN G28538-xxx)</p> <p>(1) – 410 mm front panel cable – iPN H26893-xxx</p> <p>(1) – 640 mm front panel USB 2.0 cable – iPN H20005-xxx</p> <p>(1) – RFID antenna – iPN H69566-xxx</p> <p>(1) – 175 mm backplane I2C cable – iPN H91172-xxx</p> <p>(1) – 800 mm mini SAS HD cable – iPC AXXCBL800HDHD</p> <p>(1) – 875 mm mini SAS HD cable – iPC AXXCBL875HDHD</p> <p>(1) – 950 mm mini SAS HD cable – iPC AXXCBL950HDHD</p> <p>(1) – 525/675 mm backplane power cable – iPN H82097-xxx</p> <p>(1) – Standard 2U air duct – iPN H90554-xxx</p> <p>(6) – Hot-swap system fans – iPC FR2UFAN60HSW</p> <p>(16) – DIMM slot blanks – iPN G75158-00x</p> <p>(2) – 1300W AC power supply module – iPC AXX1300TCRPS</p> <p>(2) – AC power cord retention strap assembly – iPN H23961-00x</p> <p>(2) – CPU heat sinks – iPC FXXCA78X108HS</p> <p>(2) – Standard CPU carrier – iPN H72851-xxx</p> <p>(1) – 3x Intel® RAID Maintenance Free Backup unit mounting bracket – iPN H18238-00x</p> <p>(1) – 250 mm fixed mount SSD power cable – iPN J29245-xxx</p> <p>Spares for each screw type included</p>	<ul style="list-style-type: none"> • Power cord(s) – See Section 5.6 • Rack mount kit – See Section 5.7 	<p>Note: By default, the front drive bays are cabled to onboard SATA only ports. An add-in SAS card or module is needed to support SAS devices.</p> <ul style="list-style-type: none"> • Intel® Ethernet Network Adapter for OCP* – See Chapter 5.4 for available options • Intel® 12G SAS RAID module and Intel® RAID Maintenance Free Backup unit – See Chapter 5.5 for available options • SAS data cables – Depending on the location of the SAS data controller, new data cables may be necessary. See Chapter 4. • PCIe* OCuLink data cables (1 per NVMe* drive) – See Chapter 4 • SATA upgrade key for Intel® Embedded Server Technology 2 RAID 5 support – iPC RKSATA4R5 • Rear mount hot-swap drive bay accessory kit – iPC A2UREARHSDK2 • ECC DDR4 memory (RDIMM or LRDIMM) • Storage drives <p>See Chapters 5 and 6 for all available accessory options.</p>																						

Table 42. Intel® Server System LFRB2312WFTF601 product specifications and configuration requirements


Intel® Server System LFRB2312WFTF601 2U, Intel® Server Board S2600WFTF, 12 x 3.5" HDD or 12 x 2.5" SSD SATA/SAS front mount drives (support for up to 2 NVMe* drives), Intel® Xeon® Gold 6130H processor														
	<p>This part is no longer available to order. See PCN 116985-00 for more details.</p> <p>iPC LFRB2312WFTF601 MM# 974990 UPC 00735858388771 EAN 5032037137324 MOQ 1</p>	<table border="0"> <tr> <td>Product type</td> <td>L9 integrated system</td> </tr> <tr> <td>Chassis form factor</td> <td>2U rack mount</td> </tr> <tr> <td>Packaged gross wt.</td> <td>25.0 kg (55.0 lb)</td> </tr> <tr> <td>Un-packaged net wt.</td> <td>17.9 kg (39.5 lb)</td> </tr> <tr> <td>Chassis dimensions</td> <td>712 x 439 x 89 mm (L x W x H)</td> </tr> <tr> <td>Package dimensions</td> <td>983 x 577 x 260 mm (L x W x H)</td> </tr> </table>	Product type	L9 integrated system	Chassis form factor	2U rack mount	Packaged gross wt.	25.0 kg (55.0 lb)	Un-packaged net wt.	17.9 kg (39.5 lb)	Chassis dimensions	712 x 439 x 89 mm (L x W x H)	Package dimensions	983 x 577 x 260 mm (L x W x H)
Product type	L9 integrated system													
Chassis form factor	2U rack mount													
Packaged gross wt.	25.0 kg (55.0 lb)													
Un-packaged net wt.	17.9 kg (39.5 lb)													
Chassis dimensions	712 x 439 x 89 mm (L x W x H)													
Package dimensions	983 x 577 x 260 mm (L x W x H)													
Included	Required Items (sold separately)	Optional Accessories (sold separately)												
<p>(1) – 2U Chassis with Quick Reference Label affixed to top cover (1) – Intel® Server Board S2600WFTF (dual 10GbE LAN) – iPC S2600WFTF (2) – Intel® Xeon® Gold 6130H processor (2) – 16 GB, RDIMM, DDR4, 2666 memory module – iPN J26609-002 (1) – Intel® Remote Management Module 4 Lite 2 – iPC AXXRMM4LITE2 (2) – PCIe* riser card brackets. Includes: o (2) 3-slot PCIe* riser cards – iPC A2UL8RISER2 o (1) 2-slot low profile PCIe* riser card – iPC A2UX8X4RISER (12) – 3.5" hot-swap drive bays with drive carriers and blanks. Includes: o (1) SAS/NVMe* combo backplane – iPC F2U12X35S3PH o (12) 3.5" hot-swap drive tool less carriers – iPC FXX35HSCAR2 (1) – Storage rack handles set – iPN H98453-001 (1) – Mini front panel (board only – iPN G28538-xxx) (1) – 410 mm front panel cable – iPN H26893-xxx (1) – 640 mm front panel USB 2.0 cable – iPN H20005-xxx (1) – RFID antenna – iPN H69566-xxx (1) – 175 mm backplane I2C cable – iPN H91172-xxx (1) – 800 mm mini SAS HD cable – iPC AXXCBL800HDHD (1) – 875 mm mini SAS HD cable – iPC AXXCBL875HDHD (1) – 950 mm mini SAS HD cable – iPC AXXCBL950HDHD (1) – 525/675 mm backplane power cable – iPN H82097-xxx (1) – Standard 2U air duct – iPN H90554-xxx (6) – Hot-swap system fans – iPC FR2UFAN60HSW (16) – DIMM slot blanks – iPN G75158-00x (2) – 1300W AC power supply module – iPC AXX1300TCRPS (2) – AC power cord retention strap assembly – iPN H23961-00x (2) – CPU heat sinks – iPC FXXCA78X108HS (2) – Standard CPU carrier – iPN H72851-xxx (1) – 3x Intel® RAID Maintenance Free Backup unit mounting bracket – iPN H18238-00x (1) – 250 mm fixed mount SSD power cable – iPN J29245-xxx Spares for each screw type included</p>	<ul style="list-style-type: none"> • Power cord(s) – See Section 5.6 • Rack mount kit – See Section 5.7 	<p>Note: By default, the front drive bays are cabled to onboard SATA only ports. An add-in SAS card or module is needed to support SAS devices.</p> <ul style="list-style-type: none"> • Intel® Ethernet Network Adapter for OCP* – See Chapter 5.4 for available options • Intel® 12G SAS RAID module and Intel® RAID Maintenance Free Backup unit – See Chapter 5.5 for available options • SAS data cables – Depending on the location of the SAS data controller, new data cables may be necessary. See Chapter 4. • PCIe* OCuLink data cables (1 per NVMe* drive) – See Chapter 4 • SATA upgrade key for Intel® Embedded Server Technology 2 RAID 5 support – iPC RKSATA4R5 • Rear mount hot-swap drive bay accessory kit – iPC A2UREARHSDK2 • ECC DDR4 memory (RDIMM or LRDIMM) • Storage drives <p>See Chapters 5 and 6 for all available accessory options.</p>												

Table 43. Intel® Server System LFRB2312WFTF401 product specifications and configuration requirements


Intel® Server System LFRB2312WFTF401 2U, Intel® Server Board S2600WFTF, 12 x 3.5" HDD or 12 x 2.5" SSD SATA/SAS front mount drives (support for up to 2 NVMe* drives), Intel® Xeon® Silver 4106H processor																								
	<p>This part is no longer available to order. See PCN 116985-00 for more details.</p> <table border="0"> <tr> <td>iPC</td> <td>LFRB2312WFTF401</td> </tr> <tr> <td>MM#</td> <td>982903</td> </tr> <tr> <td>UPC</td> <td>00735858387323</td> </tr> <tr> <td>EAN</td> <td>5032037136235</td> </tr> <tr> <td>MOQ</td> <td>1</td> </tr> </table>	iPC	LFRB2312WFTF401	MM#	982903	UPC	00735858387323	EAN	5032037136235	MOQ	1	<table border="0"> <tr> <td>Product type</td> <td>L9 integrated system</td> </tr> <tr> <td>Chassis form factor</td> <td>2U rack mount</td> </tr> <tr> <td>Packaged gross wt.</td> <td>25.0 kg (55.0 lb)</td> </tr> <tr> <td>Un-packaged net wt.</td> <td>17.9 kg (39.5 lb)</td> </tr> <tr> <td>Chassis dimensions</td> <td>712 x 439 x 89 mm (L x W x H)</td> </tr> <tr> <td>Package dimensions</td> <td>983 x 577 x 260 mm (L x W x H)</td> </tr> </table>	Product type	L9 integrated system	Chassis form factor	2U rack mount	Packaged gross wt.	25.0 kg (55.0 lb)	Un-packaged net wt.	17.9 kg (39.5 lb)	Chassis dimensions	712 x 439 x 89 mm (L x W x H)	Package dimensions	983 x 577 x 260 mm (L x W x H)
iPC	LFRB2312WFTF401																							
MM#	982903																							
UPC	00735858387323																							
EAN	5032037136235																							
MOQ	1																							
Product type	L9 integrated system																							
Chassis form factor	2U rack mount																							
Packaged gross wt.	25.0 kg (55.0 lb)																							
Un-packaged net wt.	17.9 kg (39.5 lb)																							
Chassis dimensions	712 x 439 x 89 mm (L x W x H)																							
Package dimensions	983 x 577 x 260 mm (L x W x H)																							
Included	Required Items (sold separately)	Optional Accessories (sold separately)																						
<p>(1) – 2U Chassis with Quick Reference Label affixed to top cover (1) – Intel® Server Board S2600WFTF (dual 10GbE LAN) – iPC S2600WFTF (2) – Intel® Xeon® Silver 4106H processor (2) – 16 GB, RDIMM, DDR4, 2666 memory module – iPN J26609-002 (1) – Intel® Remote Management Module 4 Lite 2 – iPC AXXRMM4LITE2 (2) – PCIe* riser card brackets. Includes: o (2) 3-slot PCIe* riser cards – iPC A2UL8RISER2 o (1) 2-slot low profile PCIe* riser card – iPC A2UX8X4RISER (12) – 3.5" hot-swap drive bays with drive carriers and blanks. Includes: o (1) SAS/NVMe* combo backplane – iPC F2U12X35S3PH o (12) 3.5" hot-swap drive tool less carriers – iPC FXX35HSCAR2 (1) – Storage rack handles set – iPN H98453-001 (1) – Mini front panel (board only – iPN G28538-xxx) (1) – 410 mm front panel cable – iPN H26893-xxx (1) – 640 mm front panel USB 2.0 cable – iPN H20005-xxx (1) – RFID antenna – iPN H69566-xxx (1) – 175 mm backplane I2C cable – iPN H91172-xxx (1) – 800 mm mini SAS HD cable – iPC AXXCBL800HDHD (1) – 875 mm mini SAS HD cable – iPC AXXCBL875HDHD (1) – 950 mm mini SAS HD cable – iPC AXXCBL950HDHD (1) – 525/675 mm backplane power cable – iPN H82097-xxx (1) – Standard 2U air duct – iPN H90554-xxx (6) – Hot-swap system fans – iPC FR2UFAN60HSW (16) – DIMM slot blanks – iPN G75158-00x (2) – 1300W AC power supply module – iPC AXX1300TCRPS (2) – AC power cord retention strap assembly – iPN H23961-00x (2) – CPU heat sinks – iPC FXXCA78X108HS (2) – Standard CPU carrier – iPN H72851-xxx (1) – 3x Intel® RAID Maintenance Free Backup unit mounting bracket – iPN H18238-00x (1) – 250 mm fixed mount SSD power cable – iPN J29245-xxx Spares for each screw type included</p>	<ul style="list-style-type: none"> • Power cord(s) – See Section 5.6 • Rack mount kit – See Section 5.7 	<p>Note: By default, the front drive bays are cabled to onboard SATA only ports. An add-in SAS card or module is needed to support SAS devices.</p> <ul style="list-style-type: none"> • Intel® Ethernet Network Adapter for OCP* – See Chapter 5.4 for available options • Intel® 12G SAS RAID module and Intel® RAID Maintenance Free Backup unit – See Chapter 5.5 for available options • SAS data cables – Depending on the location of the SAS data controller, new data cables may be necessary. See Chapter 4. • PCIe* OCuLink data cables (1 per NVMe* drive) – See Chapter 4 • SATA upgrade key for Intel® Embedded Server Technology 2 RAID 5 support – iPC RKSATA4R5 • Rear mount hot-swap drive bay accessory kit – iPC A2UREARHSDK2 • ECC DDR4 memory (RDIMM or LRDIMM) • Storage drives <p>See Chapters 5 and 6 for all available accessory options.</p>																						

Table 44. Intel® Server System R2224WFQZS product specifications and configuration requirements


Intel® Server System R2224WFQZS 2U, Intel® Server Board S2600WFQ, 12 x 3.5" HDD or 12 x 2.5" SSD SATA/SAS front mount drives														
	<p>This part is no longer available to order, see PCN116894-02 for more details.</p>	<table border="0"> <tr> <td>Product type</td> <td>L6 integrated system</td> </tr> <tr> <td>Chassis form factor</td> <td>2U rack mount</td> </tr> <tr> <td>Packaged gross wt.</td> <td>24.1 kg (53.1 lb)</td> </tr> <tr> <td>Un-packaged net wt.</td> <td>17.6 kg (38.6 lb)</td> </tr> <tr> <td>Chassis dimensions</td> <td>712 x 439 x 89 mm (L x W x H)</td> </tr> <tr> <td>Package dimensions</td> <td>983 x 577 x 260 mm (L x W x H)</td> </tr> </table>	Product type	L6 integrated system	Chassis form factor	2U rack mount	Packaged gross wt.	24.1 kg (53.1 lb)	Un-packaged net wt.	17.6 kg (38.6 lb)	Chassis dimensions	712 x 439 x 89 mm (L x W x H)	Package dimensions	983 x 577 x 260 mm (L x W x H)
Product type	L6 integrated system													
Chassis form factor	2U rack mount													
Packaged gross wt.	24.1 kg (53.1 lb)													
Un-packaged net wt.	17.6 kg (38.6 lb)													
Chassis dimensions	712 x 439 x 89 mm (L x W x H)													
Package dimensions	983 x 577 x 260 mm (L x W x H)													
<p>Included</p>	<p>Required Items (sold separately)</p>	<p>Optional Accessories (sold separately)</p>												
<p>(1) – 2U Chassis with Quick Reference Label affixed to top cover (1) – Intel® Server Board S2600WFQ (Intel® QAT support) – iPC S2600WFQ (2) – PCIe* riser card brackets. Includes: o (2) 3-slot PCIe* riser cards – iPC A2UL8RISER2 o (1) 2-slot low profile PCIe* riser card – iPC A2UX8X4RISER (24) – 2.5" hot-swap drive bays with drive carriers and blanks. Includes: o (3) SAS/NVMe* combo backplane – iPC F2U8X25S3PHS o (24) 2.5" hot-swap drive tool less carriers – iPC FXX25HSCAR3 (1) – Storage rack handle assembly – iPC A2UHANDLKIT o 1 set storage rack handles o Mini front panel (board only – iPN G28538-xxx) o 410 mm front panel cable – iPN H26893-xxx o 640 mm front panel USB 2.0 cable iPN H20005-xxx (1) – 250 mm backplane I2C cable – iPN H91166-xxx (2) – 100 mm backplane to backplane I2C jumper cable – iPN H91163-xxx (4) – 875 mm mini SAS HD VT-VT cable – iPC AXXCBL875HDHD (1) – 400/525/675 mm backplane power cable – iPN H82108-xxx (1) – 290 mm Intel® QAT cable – iPN J61138-xxx (1) – Standard 2U air duct – iPN H90554-xxx (6) – Hot-swap system fans – iPC FR2UFAN60HSW (16) – DIMM slot blanks – iPN G75158-00x (1) – 1300W AC power supply module – iPC AXX1300TCRPS (1) – Power supply bay blank insert (2) – AC Power cord retention strap assembly – iPN H23961-00x (2) – CPU heat sinks – iPC FXXCA78X108HS (2) – CPU heat sink “NO CPU” Mylar* spacer insert – iPN J16115-XXX (2) – Standard CPU carrier – iPN H72851-xxx (1) – 3x Intel® RAID Maintenance Free Backup unit mounting bracket – iPN H18238-00x (1) – 250 mm fixed mount SSD power cable – iPN J29245-xxx Spares for each screw type included</p>	<ul style="list-style-type: none"> • Power cord(s) – See Section 5.6 • Rack mount kit – See Section 5.7 • (1) or (2) 1st or 2nd Intel® Xeon® processor Scalable family (support for 2nd Gen Intel® Xeon® processor Scalable family requires a system software stack update from http://downloadcenter.intel.com) • ECC DDR4 memory (RDIMM or LRDIMM) 	<p>Note: 4-port mini-SAS HD connectors are present on S2600WFQ but are not configured as SATA; these cables are used only for Intel® QAT. An add-in SAS card or module is needed to support SATA/SAS front devices.</p> <ul style="list-style-type: none"> • Second 1300W AC power supply module to support power redundancy – iPC AXX1300TCRPS • Intel® Ethernet Network Adapter for OCP* – See Chapter 5.4 for available options • Intel® 12G SAS RAID module and Intel® RAID Maintenance Free Backup unit – See Chapter 5.5 for available options • SAS data cables – Depending on the location of the SAS data controller, new data cables may be necessary. See Chapter 4. • PCIe* OCuLink data cables (1 per NVMe* drive) – See Chapter 4 • SATA upgrade key for Intel® Embedded Server Technology 2 RAID 5 support – iPC RKSATA4R5 • Rear mount hot-swap drive bay accessory kit – iPC A2UREARHSDK2 • 4-port PCIe* Gen3 x8 switch add-in card – iPC AXXP3SWX08040 • 8-port PCIe* Gen3 x8 switch add-card – iPC AXXP3SWX08080 • Storage drives 												
<p>See Chapters 5 and 6 for all available accessory options.</p>														

Table 45. Intel® Server System R2224WFTZS product specifications and configuration requirements



Intel® Server System R2224WFTZS 2U, Intel® Server Board S2600WFT, 12 x 3.5" HDD or 12 x 2.5" SSD SATA/SAS front mount drives																								
	<p>This part is no longer available to order, refer to replacement part MM# 986051. See PCN116894-02 for more details.</p> <table border="0"> <tr> <td>iPC</td> <td>R2224WFTZS</td> </tr> <tr> <td>MM#</td> <td>975895</td> </tr> <tr> <td>UPC</td> <td>00735858344777</td> </tr> <tr> <td>EAN</td> <td>5032037105484</td> </tr> <tr> <td>MOQ</td> <td>1</td> </tr> </table>	iPC	R2224WFTZS	MM#	975895	UPC	00735858344777	EAN	5032037105484	MOQ	1	<table border="0"> <tr> <td>Product type</td> <td>L6 integrated system</td> </tr> <tr> <td>Chassis form factor</td> <td>2U rack mount</td> </tr> <tr> <td>Packaged gross wt.</td> <td>24.1 kg (53.1 lb)</td> </tr> <tr> <td>Un-packaged net wt.</td> <td>17.6 kg (38.6 lb)</td> </tr> <tr> <td>Chassis dimensions</td> <td>712 x 439 x 89 mm (L x W x H)</td> </tr> <tr> <td>Package dimensions</td> <td>983 x 577 x 260 mm (L x W x H)</td> </tr> </table>	Product type	L6 integrated system	Chassis form factor	2U rack mount	Packaged gross wt.	24.1 kg (53.1 lb)	Un-packaged net wt.	17.6 kg (38.6 lb)	Chassis dimensions	712 x 439 x 89 mm (L x W x H)	Package dimensions	983 x 577 x 260 mm (L x W x H)
iPC	R2224WFTZS																							
MM#	975895																							
UPC	00735858344777																							
EAN	5032037105484																							
MOQ	1																							
Product type	L6 integrated system																							
Chassis form factor	2U rack mount																							
Packaged gross wt.	24.1 kg (53.1 lb)																							
Un-packaged net wt.	17.6 kg (38.6 lb)																							
Chassis dimensions	712 x 439 x 89 mm (L x W x H)																							
Package dimensions	983 x 577 x 260 mm (L x W x H)																							
Included	Required Items (sold separately)	Optional Accessories (sold separately)																						
<ul style="list-style-type: none"> (1) – 2U Chassis with Quick Reference Label affixed to top cover (1) – Intel® Server Board S2600WFT (dual 10 GbE LAN) – iPC S2600WFT (2) – PCIe* riser card brackets. Includes: <ul style="list-style-type: none"> o (2) 3-slot PCIe* riser cards – iPC A2UL8RISER2 o (1) 2-slot low profile PCIe* riser card – iPC A2UX8X4RISER (24) – 2.5" hot-swap drive bays with drive carriers and blanks. Includes: <ul style="list-style-type: none"> o (3) SAS/NVMe* combo backplane – iPC F2U8X25S3PHS o (24) 2.5" hot-swap drive tool less carriers – iPC FXX25HSCAR3 (1) – Storage rack handle assembly – iPC A2UHANDLKIT <ul style="list-style-type: none"> o 1 set storage rack handles o Mini front panel (board only – iPN G28538-xxx) o 410 mm front panel cable – iPN H26893-xxx o 640 mm front panel USB 2.0 cable iPN H20005-xxx (1) – 250 mm backplane I2C cable – iPN H91166-xxx (2) – 75 mm backplane to backplane I2C jumper cable – iPN H91163-xxx (2) – 730 mm mini SAS HD VT-VT cable – iPC AXXCBL730HDHD (4) – 875 mm mini SAS HD VT-VT cable – iPC AXXCBL875HDHD (1) – 400/525/675 mm backplane power cable – iPN H82108-xxx (1) – Standard 2U air duct – iPN H90554-xxx (6) – Hot-swap system fans – iPC FR2UFAN60HSW (16) – DIMM slot blanks – iPN G75158-00x (1) – 1300W AC power supply module – iPC AXX1300TCRPS (1) – Power supply bay blank insert (2) – AC Power cord retention strap assembly – iPN H23961-00x (2) – CPU heat sinks – iPC FXXCA78X108HS (2) – CPU heat sink "NO CPU" Mylar* spacer insert – iPN J16115-XXX (2) – Standard CPU carrier – iPN H72851-xxx (1) – 3x Intel® RAID Maintenance Free Backup unit mounting bracket – iPN H18238-00x (1) – 250 mm fixed mount SSD power cable – iPN J29245-xxx <p>Spares for each screw type included</p>	<ul style="list-style-type: none"> • Power cord(s) – See Section 5.6 • Rack mount kit – See Section 5.7 • (1) or (2) 1st or 2nd Intel® Xeon® processor Scalable family (support for 2nd Gen Intel® Xeon® processor Scalable family requires a system software stack update from http://downloadcenter.intel.com) • ECC DDR4 memory (RDIMM or LRDIMM) 	<p>Note: By default the front drive bays are cabled to onboard SATA only ports. An add-in SAS card or module is needed to support SAS devices.</p> <ul style="list-style-type: none"> • Second 1300W AC power supply module to support power redundancy – iPC AXX1300TCRPS • Intel® Ethernet Network Adapter for OCP* – See Chapter 5.4 for available options • Intel® 12G SAS RAID module and Intel® RAID Maintenance Free Backup unit – See Chapter 5.5 for available options • SAS data cables – Depending on the location of the SAS data controller, new data cables may be necessary. See Chapter 4. • PCIe* OCuLink data cables (1 per NVMe* drive) – See Chapter 4 • SATA upgrade key for Intel® Embedded Server Technology 2 RAID 5 support – iPC RKSATA4R5 • Rear mount hot-swap drive bay accessory kit – iPC A2UREARHSDK2 • 4-port PCIe* Gen3 x8 switch add-in card – iPC AXXP3SWX08040 • 8-port PCIe* Gen3 x8 switch add-card – iPC AXXP3SWX08080 • Storage drives <p>See Chapters 5 and 6 for all available accessory options.</p>																						

Table 46. Intel® Server System R2224WFTZSR product specifications and configuration requirements

Intel® Server System R2224WFTZSR 2U, Intel® Server Board S2600WFTR, 12 x 3.5" HDD or 12 x 2.5" SSD SATA/SAS front mount drives																									
	<table border="0"> <tr><td>iPC</td><td>R2224WFTZSR</td></tr> <tr><td>MM#</td><td>986051</td></tr> <tr><td>UPC</td><td>00735858406864</td></tr> <tr><td>EAN</td><td>5032037151122</td></tr> <tr><td>MOQ</td><td>1</td></tr> </table>	iPC	R2224WFTZSR	MM#	986051	UPC	00735858406864	EAN	5032037151122	MOQ	1	<table border="0"> <tr><td>Product type</td><td>L6 integrated system</td></tr> <tr><td>Chassis form factor</td><td>2U rack mount</td></tr> <tr><td>Packaged gross wt.</td><td>24.1 kg (53.1 lb)</td></tr> <tr><td>Un-packaged net wt.</td><td>17.6 kg (38.6 lb)</td></tr> <tr><td>Chassis dimensions</td><td>712 x 439 x 89 mm (L x W x H)</td></tr> <tr><td>Package dimensions</td><td>983 x 577 x 260 mm (L x W x H)</td></tr> </table>	Product type	L6 integrated system	Chassis form factor	2U rack mount	Packaged gross wt.	24.1 kg (53.1 lb)	Un-packaged net wt.	17.6 kg (38.6 lb)	Chassis dimensions	712 x 439 x 89 mm (L x W x H)	Package dimensions	983 x 577 x 260 mm (L x W x H)	
iPC	R2224WFTZSR																								
MM#	986051																								
UPC	00735858406864																								
EAN	5032037151122																								
MOQ	1																								
Product type	L6 integrated system																								
Chassis form factor	2U rack mount																								
Packaged gross wt.	24.1 kg (53.1 lb)																								
Un-packaged net wt.	17.6 kg (38.6 lb)																								
Chassis dimensions	712 x 439 x 89 mm (L x W x H)																								
Package dimensions	983 x 577 x 260 mm (L x W x H)																								
Included	Required Items (sold separately)	Optional Accessories (sold separately)																							
<p>(1) – 2U Chassis with Quick Reference Label affixed to top cover</p> <p>(1) – Intel® Server Board S2600WFTR (dual 10 GbE LAN) – iPC S2600WFTR</p> <p>(2) – PCIe* riser card brackets. Includes:</p> <ul style="list-style-type: none"> o (2) 3-slot PCIe* riser cards – iPC A2UL8RISER2 o (1) 2-slot low profile PCIe* riser card – iPC A2UX8X4RISER <p>(24) – 2.5" hot-swap drive bays with drive carriers and blanks. Includes:</p> <ul style="list-style-type: none"> o (3) SAS/NVMe* combo backplane – iPC F2U8X25S3PHS o (24) 2.5" hot-swap drive tool less carriers – iPC FXX25HSCAR3 <p>(1) – Storage rack handle assembly – iPC A2UHANDLKIT</p> <ul style="list-style-type: none"> o 1 set storage rack handles o Mini front panel (board only – iPN G28538-xxx) o 410 mm front panel cable – iPN H26893-xxx o 640 mm front panel USB 2.0 cable iPN H20005-xxx <p>(1) – 250 mm backplane I2C cable – iPN H91166-xxx</p> <p>(2) – 75 mm backplane to backplane I2C jumper cable – iPN H91163-xxx</p> <p>(2) – 730 mm mini SAS HD VT-VT cable – iPC AXXCBL730HDHD</p> <p>(4) – 875 mm mini SAS HD VT-VT cable – iPC AXXCBL875HDHD</p> <p>(1) – 400/525/675 mm backplane power cable – iPN H82108-xxx</p> <p>(1) – Standard 2U air duct – iPN H90554-xxx</p> <p>(6) – Hot-swap system fans – iPC FR2UFAN60HSW</p> <p>(16) – DIMM slot blanks – iPN G75158-00x</p> <p>(1) – 1300W AC power supply module – iPC AXX1300TCRPS</p> <p>(1) – Power supply bay blank insert</p> <p>(2) – AC Power cord retention strap assembly – iPN H23961-00x</p> <p>(2) – CPU heat sinks – iPC FXXCA78X108HS</p> <p>(2) – CPU heat sink “NO CPU” Mylar* spacer insert – iPN J16115-XXX</p> <p>(2) – Standard CPU carrier – iPN H72851-xxx</p> <p>(1) – 3x Intel® RAID Maintenance Free Backup unit mounting bracket – iPN H18238-00x</p> <p>(1) – 250 mm fixed mount SSD power cable – iPN J29245-xxx</p> <p>Spares for each screw type included</p>	<ul style="list-style-type: none"> • Power cord(s) – See Section 5.6 • Rack mount kit – See Section 5.7 • (1) or (2) 1st or 2nd Intel® Xeon® processor Scalable family • ECC DDR4 memory (RDIMM or LRDIMM) 	<p>Note: By default the front drive bays are cabled to onboard SATA only ports. An add-in SAS card or module is needed to support SAS devices.</p> <ul style="list-style-type: none"> • Second 1300W AC power supply module to support power redundancy – iPC AXX1300TCRPS • Intel® Ethernet Network Adapter for OCP* – See Chapter 5.4 for available options • Intel® 12G SAS RAID module and Intel® RAID Maintenance Free Backup unit – See Chapter 5.5 for available options • SAS data cables – Depending on the location of the SAS data controller, new data cables may be necessary. See Chapter 4. • PCIe* OCuLink data cables (1 per NVMe* drive) – See Chapter 4 • SATA upgrade key for Intel® Embedded Server Technology 2 RAID 5 support – iPC RKSATA4R5 • Rear mount hot-swap drive bay accessory kit – iPC A2UREARHSDK2 • 4-port PCIe* Gen3 x8 switch add-in card – iPC AXXP3SWX08040 • 8-port PCIe* Gen3 x8 switch add-card – iPC AXXP3SWX08080 • Storage drives • DDR4-compatible Intel® Optane™ DC persistent memory module (requires an installed 2nd Gen Intel® Xeon® Scalable processor) <p>See Chapters 5 and 6 for all available accessory options.</p>																							

4. SAS/SATA/NVMe* Data Cable Guide

By default, all WFT and WF0 L6 integrated systems include SATA data cables routed from the front hot swap backplane to the onboard SATA controller connectors.

SAS/SATA/NVMe* data cables are not included with any of the chassis only building block SKUs. They must be ordered separately to match the desired system configuration.

On the backside of each installed backplane is a multiport SFF-8643 mini-SAS HD data connector for each set of four SATA/SAS drives. Backplanes that include support for 2.5" PCIe* NVMe* drives also include one PCIe* OCUlink connector for each PCIe* NVMe* drive it supports. Drive numbers in the cable configuration tables match the specific cable connectors found on the given backplane.

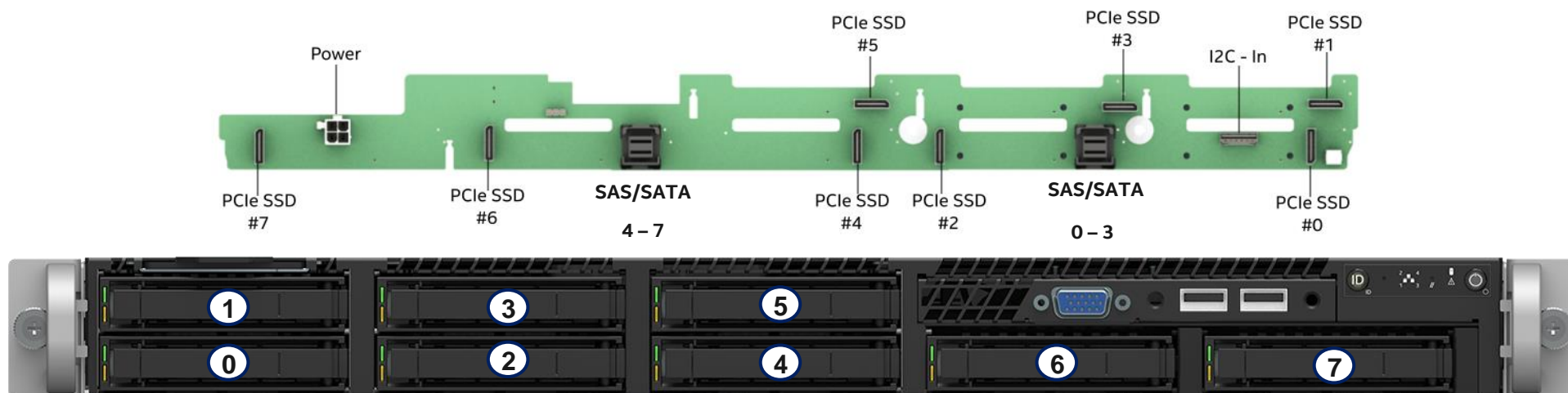


Figure 21. SAS backplane

Note: The back side (cable connector side) of a backplane will have one OCUlink cable connector for each PCIe* NVMe* SFF drive it supports. If a backplane has no OCUlink cable connectors, then it does not have support for NVMe* drives. Drive bay population rules may apply for backplanes that support SATA/SAS and PCIe* NVMe* drives. See the appropriate System Technical Product Specification for drive support information.

4.1 Cable Connector Types

Table 47. Single-port SATA cable connector

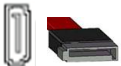
Image	Description
	<p>7-pin Single Port SATA Support for up to 6 GB/sec SATA devices Where used:</p> <ul style="list-style-type: none"> • On the server board – (2) single port SATA connectors (sSATA 4, sSATA 5) • 2U Rear Mount Hot-Swap Backplane (iPC A2UREARHSDK2)

Table 48. Multiport mini SAS HD cable connectors


Image	Description
	<p>SFF-8643 Support for up to 12 Gb/Sec SAS Where used:</p> <ul style="list-style-type: none"> • On the server board – (2) 4-port SATA connectors – (SATA 0–3 & SATA 4–7) • All 12 Gb/sec SAS capable hot swap backplanes • All 12 Gb/sec SAS RAID Controllers • All 12 Gb/sec SAS Expander Cards

Table 49. PCIe* OCuLink cable connectors



Image	Description
	<p>OCuLink connector Support for PCIe* NVMe* SFF (2.5") SSDs Where used:</p> <ul style="list-style-type: none"> • On the server board – 2 or 4 connectors (depending on the board model) • All backplanes that include support for NVMe* SFF SSDs

Table 50. Intel® Omni-Path cable connectors







Image	Description
	<p>Fabric IFT Carrier connector Support for fabric processors Support for IFT Carrier/Mezzanine boards Where Used:</p> <ul style="list-style-type: none"> • Connects a fabric processor to the SB Intel® Omni-Path IFT Carrier Kit Mezz (AWF1PFABKITM) or the SB Intel® Omni-Path IFT Carrier Kit PCIe* (AWF1PFABKITP)

4.2 1U/2U Server System SAS/SATA/NVMe* Cable Kits

Product tables in this section reference specific SAS/SATA and NVMe* cables. Different cable kits are offered to support specific system configurations. The product order code for each cable kit is made up of a string of letters and numbers to identify the type of cable included in the kit.

The following table identifies the different data cable connector types and the identifiers used in the cable kit product codes.

Table 51. Data cable connector identification

Connector Image	Cable Code	Description
	HR	Right angle SFF-8643 mini SAS HD connector
	HD	Straight SFF-8643 mini SAS HD connector
	CV	Straight NVMe* OCuLink SFF-8611 connector
	CR	Right angle NVMe* OCuLink SFF-8611 connector
	R1 L1	IFT Carrier card to Fabric Processor (Fabric Processor side) connector R1 = Right angle, right exit L1 = Right angle, left exit
	IFP	IFT Carrier card to Fabric Processor (Add-in Carrier Board/Mezzanine side) connector

4.2.1 Cable Kit Product Code Decoder Examples

SAS/SATA Data Cable Example – iPC **AXXCBL950HDMS**

- AXXCBL – Identifies an accessory cable kit
- 950 – Identifies the length of the cable in mm
- HD – Identifies that one end of the cable is an SFF-8643 type connector
- MS – Identifies that one end of the cable is an SFF-8087 type connector

NVMe* OCUlink Cable Example – iPC **AXXCBL600CVCR**

- AXXCBL – Identifies an accessory cable kit
- 600 – Identifies the length of the cable in mm
- CV – Identifies that one end of the cable is a straight NVMe* OCUlink SFF-8611 connector
- CR – Identifies that one end of the cable is a right angle NVMe* OCUlink SFF-8611 connector

4.2.2 Cable Kit Order Information

Note: The minimum order quantity (MOQ) refers to the cable kit. The kit contents may include one or more cables as listed in the product description.

Table 52. SATA/SAS/NVMe* data cable kit description and order information




Image	Details	Description
	iPC AXXCBL950HDHD MM# 936122 UPC 00735858286596 EAN 5032037066495 MOQ 1	950 mm long, cable kit (2 cables included) straight SFF8643 to straight SFF8643 Used in multiple systems as spare and/or accessory (R1304, R2308, R2312)
	iPC AXXCBL875HDHD MM# 936123 UPC 00735858284769 EAN 5032037065054 MOQ 1	875 mm long, cable kit (2 cables included) straight SFF8643 to straight SFF8643 Used in multiple systems as spare and/or accessory (R1304, R1208 R2208, R2224, R2312)
	iPC AXXCBL800HDHD MM# 937312 UPC 00735858286015 EAN 5032037066006 MOQ 1	800 mm long, cable kit (2 cables included in kit) straight SFF8643 to straight SFF8643 Used in multiple systems as spare and/or accessory (R1304, R1208, R2308, R2312)






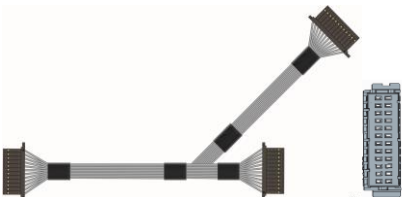
Image	Details	Description
	<p>iPC AXXCBL730HDHD MM# 936178 UPC 00735858284745 EAN 5032037065030 MOQ 1</p>	<p>730 mm long, cable kit (2 cables included) straight SFF8643 to straight SFF8643 Used in multiple systems as spare and/or accessory (R1208, R2208, R2308)</p>
	<p>iPC AXXCBL650HDHD MM# 937129 UPC 00735858284752 EAN 5032037065047 MOQ 1</p>	<p>650 mm long, cable kit (2 cables included) straight SFF8643 to straight SFF8643 Used as accessory when installing 12G ROC module in R1208 for optimal cabling. (longer cable may be used)</p>
	<p>iPC AXXCBL235IFPR1 MM# 958250 UPC 00735858346078 EAN 5032037106351 MOQ 1</p>	<p>Accessory/Spare cable kit – 235 mm long (iPN H79272-xxx), 1 cable included</p> <ul style="list-style-type: none"> • This is an accessory cable for IFT Carrier Kit AWF1PFABKITP. A required cable to connect fabric processor #2 to the PCIe* add-in IFT Carrier card installed to Riser #2 • This is a replacement cable for IFT Carrier kit AWF1PFABKITM.
	<p>iPC AXXCBL235IFPL1 MM# 958252 UPC 00735858346092 EAN 5032037106375 MOQ 1</p>	<p>Spare cable kit – 235 mm long (iPN H79267-xxx), 1 cable included This is a replacement cable for IFT Carrier kit AWF1PFABKITP. Updated 10/19</p>
	<p>iPC AXXCBL370IFPS1 MM# 958251 UPC 00735858346085 EAN 5032037106368 MOQ 1</p>	<p>Accessory cable kit – 370 mm long (iPN H79275-xxx), 1 cable included This is an accessory cable for IFT Carrier Kit AWF1PFABKITM. A required cable to connect fabric processor #2 to the Mezzanine IFT Carrier card. Update 10/19</p>
	<p>iPC AXXCBL430IFTSBY MM# 958253 UPC 00735858346108 EAN 5032037106382 MOQ 1</p>	<p>430 mm long, spare cable kit (1 cable included), bundled straight 430mm, 2x12 HFI Sideband Y Cable, Single Intel® Omni-Path Sideband IFT Carrier to dual Intel® Omni-Path CPU connectors Used to connect SB Intel® Omni-Path IFT Carrier board or Mezzanine to the server board in support of fabric processors</p>

Image	Details	Description
	<p>iPC: AXXCBL450HD7S MM#: 936428 UPC: 00735858287388 EAN: 5032037067126 MOQ: 1</p>	<p>450mm long, cable kit (2 cables included), straight SFF8643 to 7-pin SATA connectors Used in multiple systems as spare and/or accessory (R2208, R2308, R2312, R2224)</p>
	<p>iPC AXXCBL650HDHRT MM# 958254 UPC 00735858346115 EAN 5032037106399 MOQ 1</p>	<p>650 mm long, spare/accessory cable kit (2 cables included), straight HD Mini SAS SFF8643 connector to right angle HD Mini SAS SFF8643 connector Used in a R1208 as a spare and/or accessory to connect onboard mSAS-HD connectors to the HSBP connector for drives 0–3 Not compatible with SAS ROC Modules with vertical connectors in 1U systems</p>
	<p>iPC AXXCBL850HDHRS MM# 958255 UPC 00735858346122 EAN 5032037106405 MOQ 1</p>	<p>850 mm long, spare/accessory cable kit (2 cables included), straight HD Mini SAS SFF8643 connector to right angle HD Mini SAS SFF8643 connector Used in a R1208 as a spare and/or accessory:</p> <ul style="list-style-type: none"> To connect onboard mSAS-HD connectors to the HSBP drives 4–7 Required cable to support SAS ROC Modules with vertical connectors to the HSBP drives 0–3 connectors in 1U based systems
	<p>iPC AXXCBL850HDHRT MM# 958257 UPC 00735858346139 EAN 5032037106412 MOQ 1</p>	<p>850 mm long, cable kit (2 cables included), straight HD Mini SAS SFF8643 connector to right angle HD Mini SAS SFF8643 connector Used in a R1304 as a spare and/or accessory to connect mSAS-HD connectors on the server board to the HSBP to support drives 0–3 Not compatible with SAS ROC Modules with vertical connectors in 1U systems</p>
 <p>CV CR</p>	<p>iPC AXXCBL470CVCR MM# 958258 UPC 00735858346146 EAN 5032037106429 MOQ 1</p>	<p>470 mm long, accessory cable kit (1 cable included), straight OCuLink SFF-8611 connector to right angle OCuLink SFF-8611 connector Used in R1208, R2208, R2208+8, and R2224 systems to connect a server board OCuLink SSD connector to a HSBP SSD connector</p>
 <p>CV CR</p>	<p>iPC AXXCBL530CVCR MM# 958260 UPC 00735858346153 EAN 5032037106436 MOQ 1</p>	<p>530 mm long, accessory cable kit (1 cable included), straight OCuLink SFF-8611 connector to right angle OCuLink SFF-8611 connector Used in R1208, R2208, R2208+8, and R2224 systems to connect the server board OCuLink SSD connector to a HSBP SSD connector</p>
 <p>CV CR</p>	<p>iPC AXXCBL600CVCR MM# 959345 UPC 00735858346160 EAN 5032037106443 MOQ 1</p>	<p>600 mm long, accessory cable kit (1 cable included), straight OCuLink SFF-8611 connector to right angle OCuLink SFF-8611 connector Used to connect a server board OCuLink connector SSD#3 to HSBP drive 11 of the R2312 system SKUs</p>

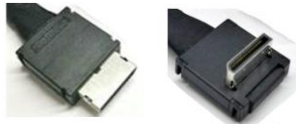
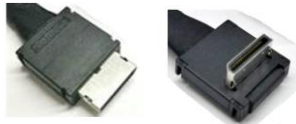
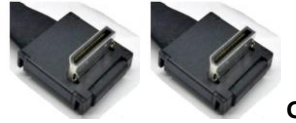




Image	Details	Description
 <p>CV CR</p>	<p>iPC AXXCBL700CVCR MM# 958261 UPC 00735858346177 EAN 5032037106450 MOQ 1</p>	<p>700 mm long, accessory cable kit (1 cable included), straight OCuLink SFF-8611 connector to right angle OCuLink SFF-8611 connector Used in R1208, R2208, R2208+8, and R2224 systems to connect the server board OCuLink SSD connector to a HSBP SSD connector</p>
 <p>CV CR</p>	<p>iPC AXXCBL800CVCR MM# 958262 UPC 00735858346184 EAN 5032037106467 MOQ 1</p>	<p>800 mm long, accessory cable kit (1 cable included), straight OCuLink SFF-8611 connector to right angle OCuLink SFF-8611 connector Used in R1208, R2208, R2208+8, and R2224 systems to connect the server board OCuLink SSD connector to a HSBP SSD connector</p>
 <p>CR CR</p>	<p>iPC AXXCBL620CRCR MM# 958263 UPC 00735858346191 EAN 5032037106474 MOQ 1</p>	<p>620 mm long, accessory cable kit (1 cable included), right angle OCuLink SFF-8611 connector to right angle OCuLink SFF-8611 connector Used to connect a server board OCuLink connector SSD#2 to HSBP drive 10 of the R2312 system SKUs</p>
	<p>iPC A1U4PRTCXCXK MM# 958358 UPC 00735858346207 EAN 5032037106481 MOQ 1</p>	<p>1U Retimer accessory cable kit, Riser 2 (1 cable included). Contains the following OCuLink bundled cable: 945 mm long, four straight OCuLink SFF-8611connectors to four straight OCuLink SFF-8611 connectors Used in the R1208 to connect AXXP3RTX16040 4-Port PCIe* SSD Retimer AIC to a PCIe* SSD capable HSBP SSD ports 4-7</p>
	<p>iPC A2U4PRTCXCXK MM# 958264 UPC 00735858346214 EAN 5032037106498 MOQ 1</p>	<p>2U Retimer accessory cable kit, Riser 2 (1 cable included). Contains the following OCuLink bundled cable: 815 mm long, straight OCuLink SFF-8611connectors to straight OCuLink SFF-8611 connectors Used in the R2208, R2208+8(Bay 1 only) and R2224 to connect AXXP3RTX16040 4-Port PCIe* SSD Retimer AIC to a PCIe* SSD capable HSBP SSD ports (1 cable kit required per retimer installed)</p>
	<p>iPC A1U4PSWCXCVK MM# 964522 UPC 00735858366502 EAN 5032037121002 MOQ 1</p>	<p>1U 4 port Switch accessory cable kit – 1U 4 port Switch accessory cable kit (1 cable included). Contains the following OCuLink bundled cable: 890 mm long, bundled cable kit (1 cable included) right-angle OCuLink SFF-8611 connectors to straight/right angle OCuLink SFF-8611 connectors Used in the R1208 to connect switch AIC to HSBP PCIe* SSD ports</p>
	<p>iPC A2U4PSWCXCXK1 MM# 958266 UPC 00735858346221 EAN 5032037106504 MOQ 1</p>	<p>2U 4 port Switch accessory cable kit (1 cable included). Contains the following OCuLink bundled cable: 755 mm long, bundled cable kit (1 cable included) straight OCuLink SFF-8611connectors to straight/right angle OCuLink SFF-8611 connectors Used in the R2208, R2208+8 and R2224 to connect switch AICs to HSBP PCIe* SSD ports (SSD ports depend on installed location of the switch AIC)</p>







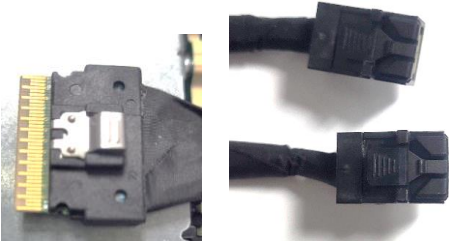
Image	Details	Description
	<p>iPC A2U4PSWCXCXK2 MM# 958267 UPC 00735858346238 EAN 5032037106511 MOQ 1</p>	<p>2U 4 port Switch accessory cable kit (1 cable included). Contains the following OcuLink bundled cable: 875 mm long, bundled cable kit (1 cable included) straight OcuLink SFF-8611 connectors to straight/right angle OcuLink SFF-8611 connectors Used in the R2208+8 to connect switch AIC to HSBP PCIe* SSD ports (SSD ports depend on installed location of the switch AIC)</p>
	<p>iPC A2U8PSWCXCXK1 MM# 958268 UPC 00735858346245 EAN 5032037106528 MOQ 1</p>	<p>2U 8 port Switch accessory cable kit, Riser 1 (2 cables included). Contains the following OcuLink bundled cables: 725 mm long, bundled cable kit (2 cables included) straight OcuLink SFF-8611 connectors to straight/right angle OcuLink SFF-8611 connectors Used in the R2208, R2208+8 and R2224 to connect switch AIC installed in Riser 1 to HSBP PCIe* SSD ports 0–7</p>
	<p>iPC A2U8PSWCXCXK2 MM# 958270 UPC 00735858346252 EAN 5032037106535 MOQ 1</p>	<p>2U 8 port Switch accessory cable kit, Riser 1 or Riser 2 (2 cables included). Contains the following OcuLink bundled cables: 875 mm long, bundled cable kit (2 cables included) straight OcuLink SFF-8611 connectors to straight/right angle OcuLink SFF-8611 connectors Used in the R2208+8 and R2224 to connect switch AIC to HSBP PCIe* SSD ports 0–7</p>
	<p>iPC A2U8PSWCXCXK3 MM# 958272 UPC 00735858346269 EAN 5032037106542 MOQ 1</p>	<p>2U 8 port Switch accessory cable kit, Riser 2 or Riser 3 (2 cables included). Contains the following OcuLink bundled cables: 810 mm long, bundled cable kit (2 cables included) straight OcuLink SFF-8611 connectors to straight/right angle OcuLink SFF-8611 connectors Used in the R2208, R2208+8 and R2224 to connect switch AIC to HSBP PCIe* SSD ports (SSD ports depend on installed location of the switch AIC)</p>
	<p>iPC AXXCBL700HDCV MM# 958273 UPC 00735858346276 EAN 5032037106559 MOQ 1</p>	<p>700 mm long, cable kit (2 cables included) straight SFF-8643 connector to dual straight OcuLink SFF-8611 connectors Used to connect Trimode RAID AICs to HSBP PCIe #0 & PCIe #1 and PCIe #2 & PCIe #3</p>
	<p>iPC A1U4PTRICXCVK MM# 984361 UPC 00735858393270 EAN 5032037140836 MOQ 1</p>	<p>Cable kit includes: (1) – 720 mm dual right angle SFF-8643 connector to dual straight OcuLink SFF-8611 connectors (1) – 750 mm dual right angle SFF-8643 connector to dual straight OcuLink SFF-8611 connectors Used to connect mezzanine Trimode adapters to HSBP PCIe #0 & PCIe #1 and PCIe #2 and PCIe #3 Used to connect mezzanine Trimode adapters to HSBP PCIe #4 & PCIe #5 and PCIe #6 and PCIe #7</p>

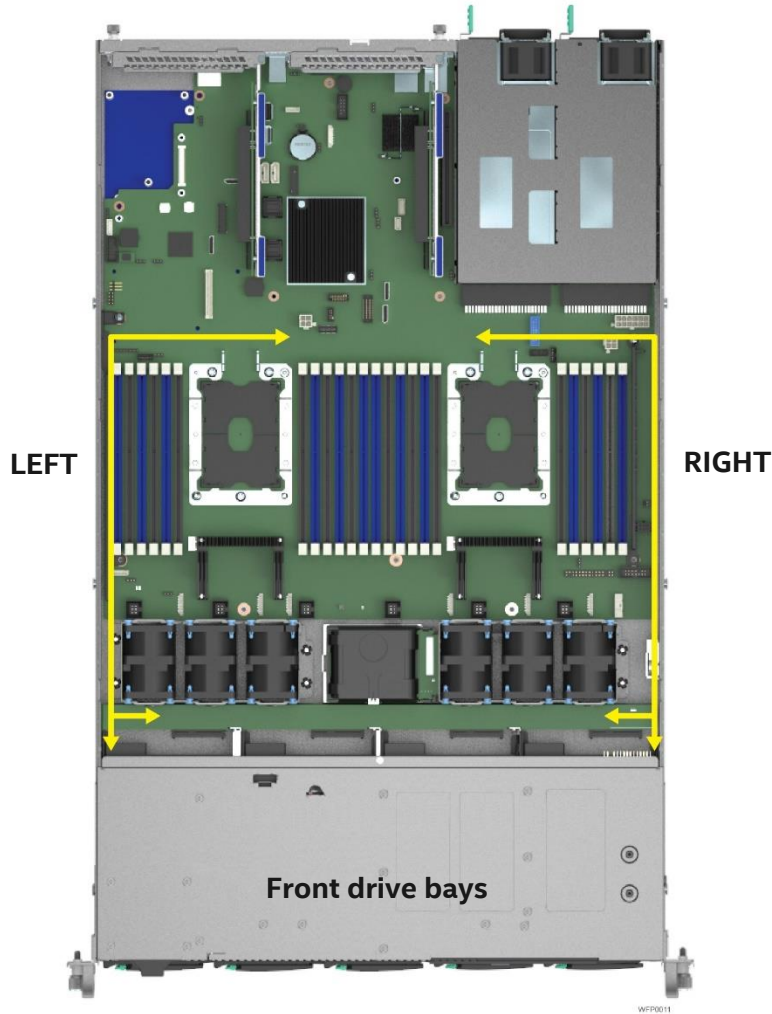
Image	Details	Description
	<p> iPC CYPBLSLHDKIT MM# 99AMXX UPC 00735858497350 EAN 5032037232494 MOQ 1 </p>	<p>Used in 1U/2U systems to connect Intel® Storage Adapter RS3P4QF160J, Intel® RAID Adapter RS3P4TF160F, and Intel® RAID Adapter RS3P4MF088F to HSBP.</p> <p>Kit Includes:</p> <ul style="list-style-type: none"> • (1) – 860 mm cable, RAID x8 SlimSAS connector to HSBP x4 Mini-SAS HD connector • (1) – 660 mm cable, RAID x8 SlimSAS connector to HSBP x4 Mini-SAS HD connector

4.2.3 Cable Recommendations

Each table in the following sections identifies the cable connections and recommended cable lengths for each supported storage controller option in the specified system. Each recommended cable length for a given connector pair provides enough cable to attach the two devices and provides the least amount of excess cable, providing the cleanest cable routing.

Refer to the following diagrams when **Right** or **Left** cable routing is specified for a given cable configuration. All cable recommendations are for a system configured for two processors.

Intel® Server System R1000WF product family cable routing



Intel® Server System R2000WF product family cable routing

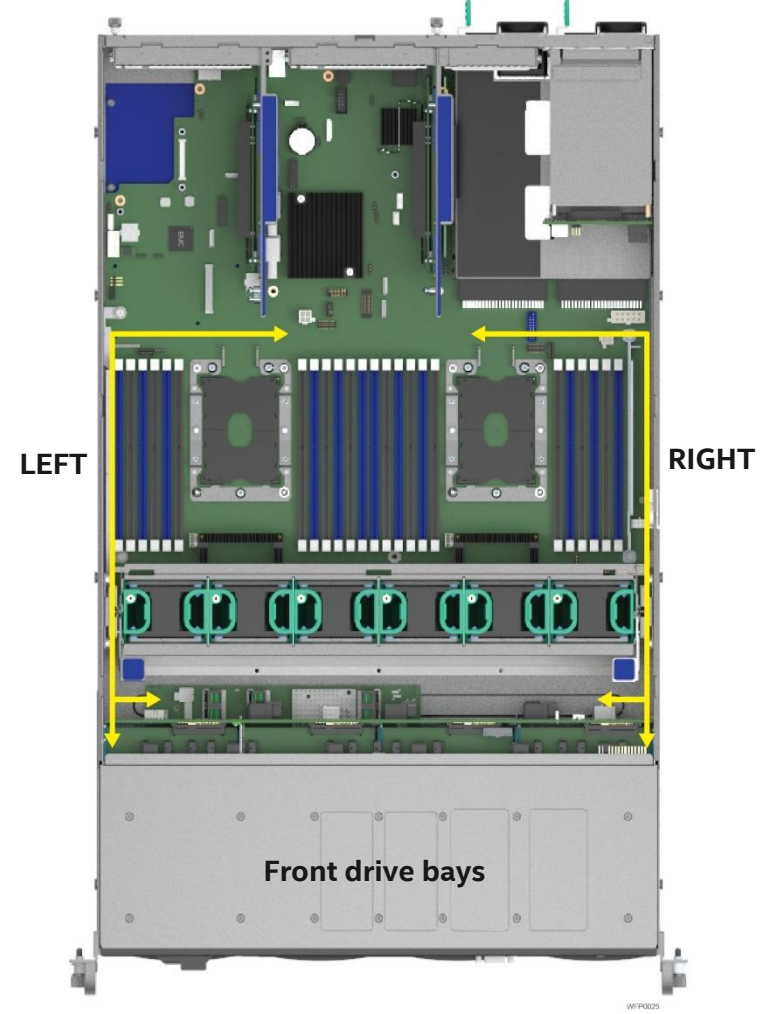


Figure 22. Server system cable routing

4.3 1U 4 x 3.5" – R1304WFxxx SAS/SATA Data Cable Guide

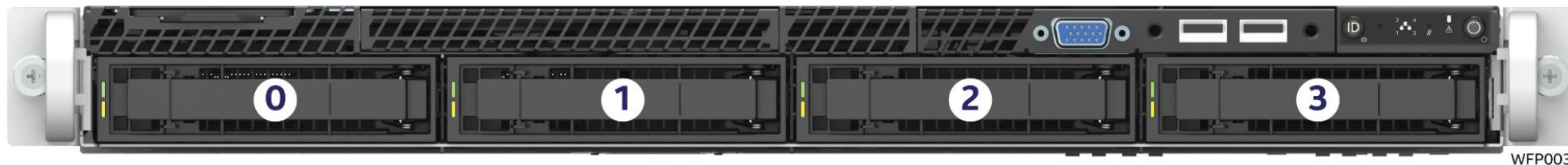


Figure 23. R1304WFxxx SAS/SATA backplane (no NVMe* drive support)

Table 53. Data cable guide for Intel® Server System R1304WFxxx

System Configuration	Drive Support	SATA Onboard Mini-SAS HD SATA Connector to Backplane (BP)	SAS Mezzanine 12 Gb SAS ROC Module to Backplane (BP)	SAS 12 Gb SAS RAID PCIe* Add-in Card to Backplane (BP)
R1304WF...	4 x 3.5" 6 Gb SATA all drives 12 Gb SAS all drives	SATA 0-3 → BP 0-3 850 mm HR --- HD AXXCBL850HDHRT L6 system ships with 1 cable	The following cable is required for Mezzanine SAS ROC modules with Horizontal connectors SAS Mezz → BP 0-3 800 mm HD --- HD AXXCBL800HDHD The following cable is required for Mezzanine SAS ROC modules with Vertical connectors AXXCBL850HDHRS	From Riser #1 SAS PCIe* → BP 0-3 ¹ 875 or 950 mm HD --- HD From Riser #2 SAS PCIe* → BP 0-3 ¹ 730 or 875 mm HD --- HD From data above, select appropriate cable kits from list below: See note below AXXCBL730HDHD AXXCBL875HDHD AXXCBL950HDHD

¹ 1 or 2 cable lengths may be specified for a PCIe* add-in card. Generally, if the cable connector of the add-in card is on the back edge of the card, a shorter cable is specified. Cable connectors on the top edge or near the front of the add-in card will require the longer cable length.

4.4 1U 8 x 2.5" – R1208WFxxx SAS/SATA/NVMe* Data Cable Guide



WFP004

Figure 24. R1208WFxxx SAS/SATA/NVMe* backplane

Table 54. Data cable guide for Intel® Server System R1208WFxxx

System Configuration	Drive Support	SATA Onboard Multiport SATA Ports to Backplane (BP)	SAS Mezzanine 12 Gb SAS ROC Module to Backplane (BP)	SAS 12 Gb SAS RAID PCIe* Add-in Card to Backplane (BP)	NVMe* Onboard PCIe* OCuLink to Backplane (BP)	NVMe 4 Port PCIe* Switch or Retimer Card to Backplane (BP)
R1208WF...	<p>8 x 2.5"</p> <p>6Gb SATA all drives 12 Gb SAS all drives</p> <p>PCIe* NVMe* SFF all drives</p>	<p>SATA 0–3 → BP 0–3 650 mm HR --- HD AXXCBL650HDHRT</p> <p>SATA 4–7 → BP 4–7 850 mm HR --- HD AXXCBL850HDHRS</p>	<p>The following cables are required for Mezzanine SAS ROC modules with Horizontal connectors:</p> <p>SAS Mezz → BP 0–3 650 mm HD --- HD AXXCBL650HDHD</p> <p>SAS Mezz → BP 4–7 800 mm HD --- HD AXXCBL800HDHD</p> <p>Mezzanine SAS ROC Modules with vertical connectors require the following cable kit AXXCBL850HDHRS for backplane drives 0–3</p>	<p>From Riser #1 SAS PCIe* → BP 0–3 650 mm HD --- HD SAS PCIe* → BP 4–7 ¹ 730 or 800 mm HD --- HD</p> <p>From Riser #2 SAS PCIe* → BP 0–3 ¹ 650 or 730mm HD --- HD SAS PCIe* → BP 4–7 ^{**} 800 or 875 mm HD --- HD</p> <p>From data above, select appropriate cable kits from list below: See notes below</p> <p>AXXCBL650HDHD AXXCBL730HDHD AXXCBL800HDHD AXXCBL875HDHD</p>	<p>PCIe* SSD 0 (CR) → BP 0 (CV) 470mm – AXXCBL470CVCR</p> <p>PCIe* SSD 1 (CR) → BP 1 (CV) 530mm – AXXCBL530CVCR</p> <p>PCIe* SSD 2 (CR) → BP 2 (CV) 800mm – AXXCBL800CVCR</p> <p>PCIe* SSD 3 (CR) → BP 3 (CV) 700mm – AXXCBL700CVCR</p>	<p>From Riser #2 Switch Card → BP 4–7 890mm – A1U4PSWCXVK</p> <p>OR</p> <p>From Riser #2 Retimer Card → BP 4–7 945mm – A1U4PRTCXVK</p>

¹ 1 or 2 cable lengths may be specified for a PCIe* add-in card. Generally, if the cable connector of the add-in card is on the back edge of the card, a shorter cable is specified. Cable connectors on the top edge or near the front of the add-in card will require the longer cable length.

4.5 2U 8 x 3.5" – R2308WFxxx SAS/SATA Data Cable Guide



Figure 25. R2308WFxxx SAS/SATA backplane (no NVMe* support)

Table 55. Data cable guide for Intel® Server System R2308WFxxx

System Configuration	Drive Support	SATA Onboard Multiport SATA Ports to Backplane (BP)	SAS Mezzanine 12 Gb SAS ROC Module to Backplane (BP)	SAS 12 Gb SAS RAID PCIe* Add-in Card to Backplane (BP)
R2308WF...	<p>8 x 3.5"</p> <p>6 Gb SATA all drives 12 Gb SAS all drives</p>	<p>SATA 0–3 → BP 0–3 730 mm HD --- HD AXXCBL730HDHD</p> <p>SATA 4–7 → BP 4–7 875 mm HD --- HD AXXCBL875HDHD</p> <p>L6 systems ship with 1 each cable</p>	<p>SAS Mezz → BP 0–3 730 mm HD --- HD AXXCBL730HDHD</p> <p>SAS Mezz → BP 4–7 875 mm HD --- HD AXXCBL875HDHD</p>	<p>From Riser #1: SAS PCIe* → BP 0–3¹ 650 or 730 mm HD --- HD SAS PCIe* → BP 4–7¹ 800 or 950 mm HD --- HD</p> <p>From Riser #2: SAS PCIe* → BP 0–3¹ 730 or 800 mm HD --- HD SAS PCIe* → BP 4–7¹ 730 or 800 mm HD --- HD</p> <p>From data above, select appropriate cable kits from list below: See Notes below AXXCBL650HDHD AXXCBL730HDHD AXXCBL800HDHD AXXCBL950HDHD</p>

¹ 1 or 2 cable lengths may be specified for a PCIe* add-in card. Generally, if the cable connector of the add-in card is on the back edge of the card, a shorter cable is specified. Cable connectors on the top edge or near the front of the add-in card will require the longer cable length.

4.6 2U 12 x 3.5 – R2312WFxxx SAS/SATA/NVMe* Data Cable Guide



Figure 26. R2312WFxxx SAS/SATA backplane (NVMe* support for drive 10 & 11 only)

4.6.1 2U 12 x 3.5" – R2312WFxxx SAS/SATA/NVMe* Data Cable Guide (with no SAS Expander)

Table 56. Data cable guide (no SAS expander) for Intel® Server System R2312WFxxx


System Configuration	Drive Support	SATA Onboard Multiport SATA Ports to Backplane (BP)	SAS Mezzanine 12 Gb SAS ROC Module to Backplane (BP)	SAS 12 Gb SAS RAID PCIe* Add-in Card to Backplane (BP)	Up to 2 x NVMe Onboard PCIe* OcuLink to Backplane (BP) drive bays 10 & 11 only
R2312WF...	<p>12 x 3.5"</p> <p>6 Gb SATA all drives 12 Gb SAS all drives</p> <p>PCIe* NVMe* SFF drives 10 & 11 only</p>	<p>SATA 0–3 → BP 0–3 800mm HD --- HD AXXCBL800HDHD</p> <p>SATA 4–7 → BP 4–7 875 mm HD --- HD AXXCBL875HDHD</p>	<p>SAS Mezz → BP 4–7 875 mm HD --- HD</p> <p>SAS Mezz → BP 8–11 950 mm HD ---HD</p> <p>From data above, select appropriate cable kits from list below:</p> <p>AXXCBL800HDHD AXXCBL875HDHD AXXCBL950HDHD</p> <p>L6 systems ship with 1 each of the cables listed.</p>	<p>From Riser #1 SAS PCIe* → BP 4–7¹ 800 or 875 mm HD --- HD SAS PCIe* → BP 8–11 875 mm HD ---HD</p> <p>From Riser #2 SAS PCIe* → BP 4–7¹ 730 or 875 mm HD --- HD SAS PCIe* → BP 8–11¹ 650 or 800 mm HD --- HD</p> <p>From data above, select appropriate cable kits (see notes below): AXXCBL650HDHD AXXCBL730HDHD AXXCBL800HDHD (1) 800mm Included in L6 AXXCBL875HDHD (1) 875mm Included in L6 AXXCBL950HDHD (1) 950mm included in L6)</p>	<p>PCIe* SSD3 (CR) → BP SSD1 (CV) 600mm AXXCBL600CVCR</p> <p>PCIe* SSD2 (CR) → BP SSD0 (CR) 620mm AXXCBL620CRCR</p> <p>Retimer add-in card is not compatible with R2312WFxxx</p>

¹ 1 or 2 cable lengths may be specified for a PCIe* add-in card. Generally, if the cable connector of the add-in card is on the back edge of the card, a shorter cable is specified. Cable connectors on the top edge or near the front of the add-in card will require the longer cable length.

4.6.2 2U 12 x 3.5" – R2312WTxxx SAS/SATA/NVMe* Data Cable Guide (with SAS Expander)

For server configurations with 12 drives, Intel recommends a 16-port SAS controller. In the 2U 12x3.5" system configuration, the SAS expander must be installed in any available PCIe* add-in slot. Intel provides one SAS expander option to support this drive configuration.

Table 57. SAS expander option

Image	Details	Description
	<p>SAS 3.0 12 Gb/s Expander</p> <p>iPC RES3FV288 MM# 932895 UPC 00735858287548 EAN 5032037067287 MOQ 5</p> <p>Product type 2U accessory kit</p>	<ul style="list-style-type: none"> • 6Gbps data aggregation for 12Gbps data transfer with 6Gb/s devices • Low Profile MD2 PCIe* add-in card form factor • 28 internal ports and 8 external ports • Redundant dual-port capable for HA and high performance systems • Power from PCIe* x1 • Mini-SAS HD 8643 Connectors <p>Kit includes: (1) SAS expander card, (2) HD-HD 250mm Expander-to-RAID card cables, PCI brackets for low profile and full height</p> <p>Required (sold separately): HD-HD SAS data cables – Expander to backplane – See Table 58</p>

Note: The onboard SATA ports are not compatible with SAS expander cards. The onboard SATA ports must be cabled directly to a specified backplane.

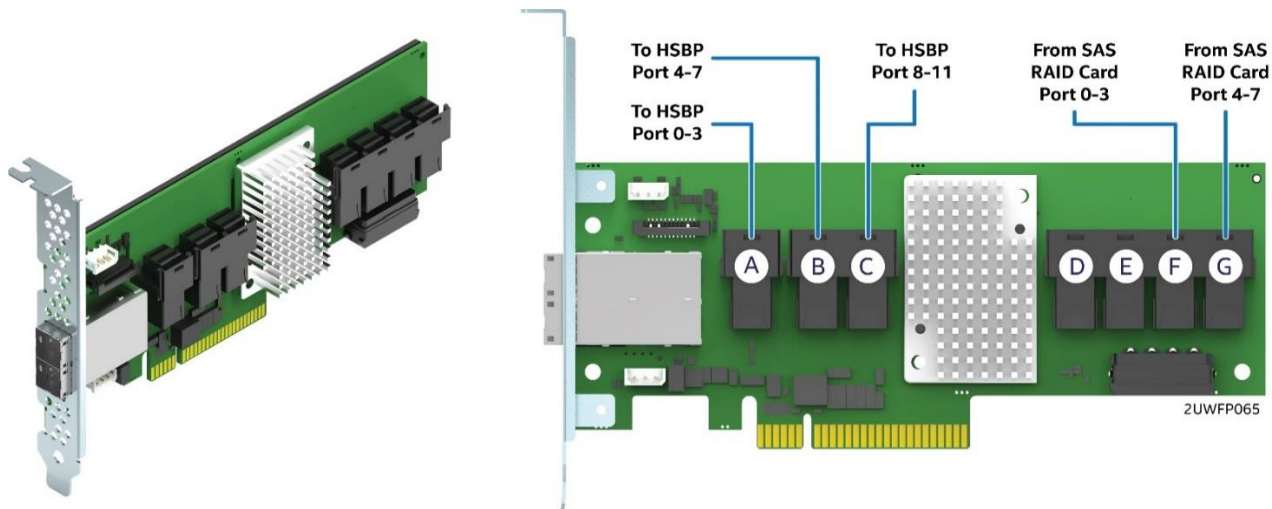


Figure 27. SAS 3.0 12 Gb/s expander

Table 58. Data cable guide (with SAS expander) for Intel® Server System R2312WFxxx

System Configuration	Drive Support	SATA Onboard Multiport SATA Ports	SAS + Expander Mezzanine 12Gb SAS ROC Module + 12 Gb SAS Expander to Backplane (BP)	SAS + Expander 12Gb SAS RAID PCIe* add-in card + 12 Gb SAS Expander to Backplane (BP)	Up to 2 x NVMe* Cables for Onboard PCIe* OcuLink to Backplane (BP) drive bays 10 & 11 only
R2312WF...	<p>12 x 3.5"</p> <p>6 Gb SATA all drives 12 Gb SAS all drives</p> <p>PCIe* NVMe* SFF drives 10 & 11 only</p>	<p>Onboard SATA controllers do not support SAS expanders.</p> <p>If attaching the onboard SATA controller to the Backplane, then use cables that are included in the System SKUs.</p> <p>For building block integration use cable kits:</p> <p>AXXCBL800HDHD AXXCBL875HDHD</p>	<p>With 12 Gb SAS Expander RES3FV288 installed in Riser #1:</p> <p>Use cables in Expander Kit to attach SAS ROC to Expander Card</p> <p>Use the following cables to attach Expander to Backplane:</p> <p>Expander → BP 0–3 800 mm HD --- HD</p> <p>Expander → BP 4–7 875 mm HD --- HD</p> <p>Expander → BP 8–11 950 mm HD ---HD</p> <p>From data above, select appropriate cable kits from list below:</p> <p>AXXCBL800HDHD AXXCBL875HDHD AXXCBL950HDHD</p> <p>L6 systems ship with 1 each of the cables listed.</p>	<p>With 12 Gb PCIe* RAID and 12 Gb SAS Expander RES3FV288 installed in riser #1:</p> <p>Use cables in Expander Kit to attach PCIe* SAS card to Expander Card</p> <p>Use the following cables to attach Expander to Backplane:</p> <p>Expander → BP 0–3 800 mm HD --- HD</p> <p>Expander → BP 4–7 875 mm HD --- HD</p> <p>Expander → BP 8–11 950 mm HD ---HD</p> <p>From data above, select appropriate cable kits from list below:</p> <p>AXXCBL800HDHD AXXCBL875HDHD AXXCBL950HDHD</p>	<p>PCIe* SSD3 (CR) → BP SSD1 (CV) 600 mm AXXCBL600CVCR</p> <p>PCIe* SSD2 (CR) → BP SSD0 (CR) 620 mm AXXCBL620CRCR</p> <p>Note: Retimer add-in card is not compatible with R2312WFxxx</p>

4.7 2U 2.5" Front Mount Drive Bay Cable Guide

The front drive bay of the 2U system can support up to three 2.5" x 8-drive bay modules, and support the following system configurations: 8 drives (**R2208**), 16 drives (**R2208 + 8 Drive Accessory Kit**), or 24 drives (**R2224**). Each of the three drive bay modules is identified by number as shown below. All eight drives of the standard 8 x 2.5" combo backplane can support SAS, SATA, and NVMe* drive types. The backside (Cable connector side) of the standard combo backplane will include two 4-port 8643 Mini-SAS HD data connectors (Ports 0–3 & Ports 4–7) for SAS/SATA support, and eight PCIe* OCuLink connectors for NVMe* support (one connector for each PCIe* NVMe* SFF drive). Each OCuLink connector is labeled with a Drive ID (0–7) which corresponds to a matching drive interface connector on the front side (drive interface side) of the backplane.

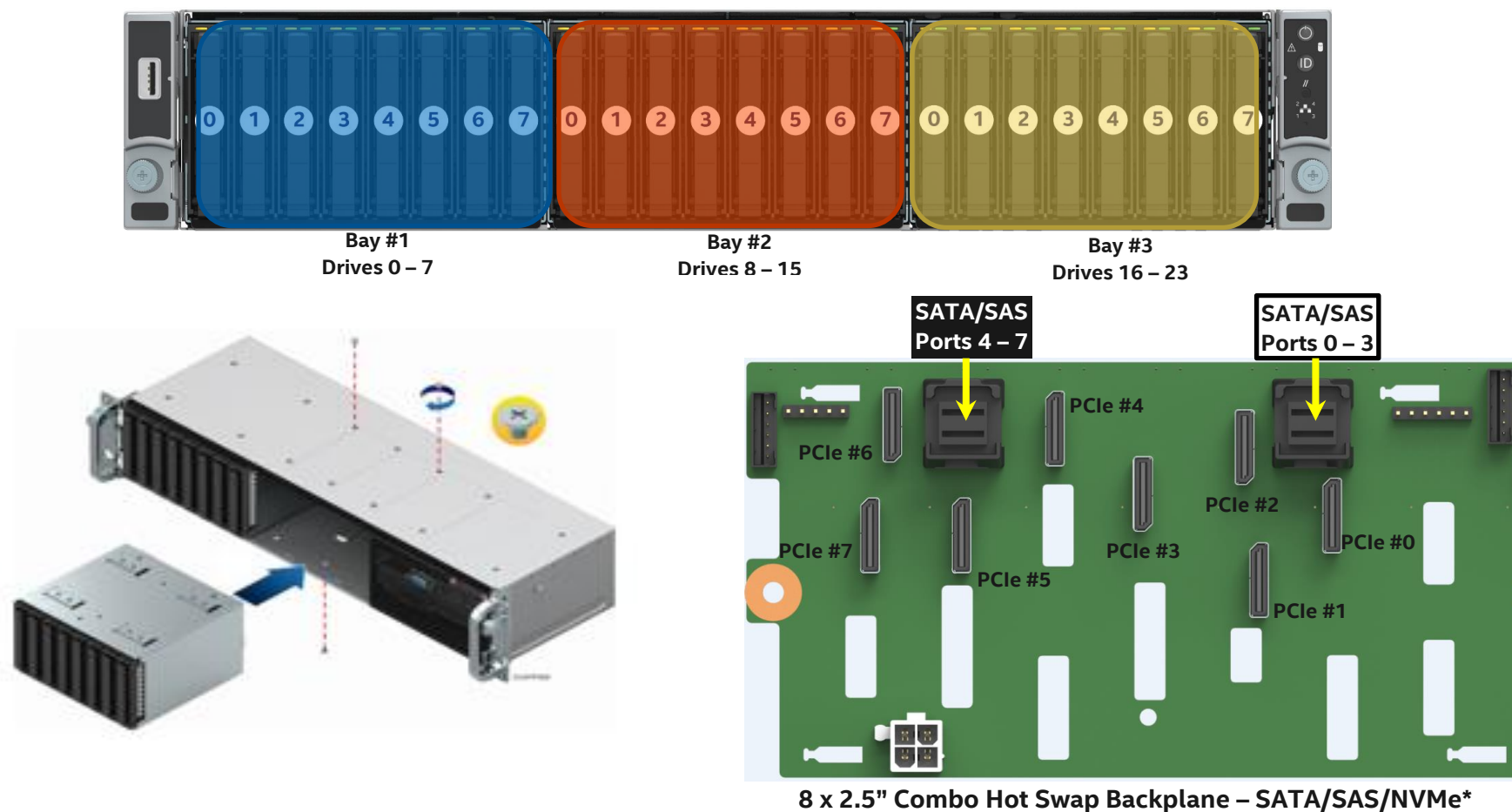


Figure 28.2.5" front mount drive bay and 8 x 2.5" combo hot-swap backplane

The following sections should be used to identify the appropriate data cables to order for specific drive configurations. Each section identifies the data cable kits necessary to route between a given data source and the backplane of a specific Drive Bay Module location within the chassis. Reference each drive bay module section as necessary to determine the cable requirements relevant to your specific drive bay configuration.

4.7.1 2U – 8x2.5" Drive Bay Module #1 – Cable Guide (with no SAS Expander)



Drive Bay #1

4.7.1.1 Drive Bay Module # 1 – SAS/SATA Cable Guide

The following table identifies the appropriate SATA/SAS data cable kit(s) necessary to route data signals from Onboard SATA ports or available SAS RAID mezzanine and PCIe* add-in options to the 8x2.5" backplane installed to **Drive Bay Module #1**.

Table 59. Drive bay module #1 SAS/SATA cable guide

System Configuration	SAS /SATA Drive Support	SATA Onboard Multiport SATA Ports to Backplane (BP) #1	SAS Mezzanine 12 Gb SAS ROC Module to Backplane (BP) #1	SAS 12 Gb SAS RAID PCIe* Add-in Card to Backplane (BP) #1
Drive Bay #1 R2208WF... R2208WF+8 R2224WF	Up to eight 2.5" SAS / SATA Drives	<p>SATA 0–3 → BP 0–3 730mm HD --- HD AXXCBL730HDHD</p> <p>SATA 4–7 → BP 4–7 730 mm HD --- HD AXXCBL730HDHD</p> <p>(2) 730mm Cables included with all WFT and WFO 2.5" L6 Integrated systems</p>	<p>SAS Mezz → BP 0–3 730 mm HD --- HD AXXCBL730HDHD</p> <p>SAS Mezz → BP 4–7 730 mm HD --- HD AXXCBL730HDHD</p> <p>(2) 730mm Cables included with all WFT and WFO 2.5" L6 Integrated systems</p>	<p>From Riser #1: SAS PCIe* → BP 0–3 730 mm HD --- HD SAS PCIe* → BP 4–7 730 mm HD --- HD</p> <p>From Riser #2 SAS PCIe* → BP 0–3 730 mm HD --- HD SAS PCIe* → BP 4–7 730 mm HD --- HD AXXCBL730HDHD</p> <p>(2) 730mm Cables included with all 2.5" L6 Integrated systems</p>

4.7.1.2 Drive Bay Module # 1 – NVMe* Cable Guide

The following table identifies the appropriate PCIe* NVMe* data cable kit(s) necessary to route PCIe* signals from any of the onboard PCIe* OCuLink connectors and / or PCIe* switch add-in card options to the 8x2.5" combo backplane installed to **Drive Bay Module #1**.

Select the cable kit or kits required to support the specific PCIe* source or sources and the appropriate number of NVMe* drives being installed to **Drive Bay Module #1 only**.

Note: CR and CV refer to the connector types at each end of the PCIe* OCuLink cable. See Table 51.

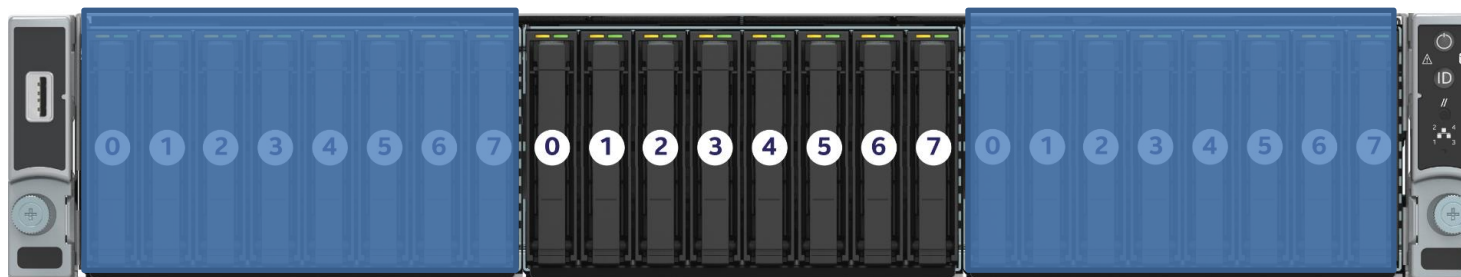
Table 60. Drive bay module #1 NVMe* cable guide

System Configuration	NVMe* Drive Support	Onboard PCIe* OCuLink to Drive Bay Module (BP) #1 Cable Kits	PCIe* Switch Card Option on Riser #1	PCIe* Switch Card Option on Riser #2	PCIe* Switch Card Option on Riser #3	PCIe* Switch Card to Drive Bay Module (BP) #1 Cable Kits	Cable Routing	
Drive Bay #1 R2208WF R2208WF +8 R2224WF	Up to Eight 2.5" NVMe* SSDs	PCIe* SSD 0 (CR) → BP 0 (CV) 470mm – AXXCBL470CVCR	4-port PCIe* Switch Add-in Card AXXP3SWX08040 any open PCIe* slot			Switch → BP ports 0–3 or Switch → BP ports 4–7 A2U4PSWCXCXK1	Left	
		PCIe* SSD 1 (CR) → BP 1 (CV) 530mm – AXXCBL530CVCR		4-port PCIe* Switch Add-in Card AXXP3SWX08040 any open PCIe* slot		Switch → BP ports 0–3 or Switch → BP ports 4–7 A2U4PSWCXCXK1	Left	
		PCIe* SSD 2 (CR) → BP 2 (CV) 700mm – AXXCBL700CVCR			4-port PCIe* Switch Add-in Card AXXP3SWX08040 PCIe* slot#2	Switch → BP ports 0–3 or Switch → BP ports 4–7 A2U4PSWCXCXK1	Left	
		PCIe* SSD 3 (CR) → BP 3 (CV) 700mm – AXXCBL700CVCR				Switch → BP ports 0–3 Cable 1 Switch → BP ports 4–7 Cable 2 A2U8PSWCXCXK1	Left Left	
		PCIe* SSD 0 (CR) → BP 4 (CV) 700mm – AXXCBL700CVCR		8-port PCIe* Switch Add-in Card AXXP3SWX08080 any open PCIe* slot			Switch → BP ports 0–3 Cable 1 Switch → BP ports 4–7 Cable 2 A2U8PSWCXCXK3	Left Left
		PCIe* SSD 1 (CR) → BP 5 (CV) 700mm – AXXCBL700CVCR			8-port PCIe* Switch Add-in Card AXXP3SWX08080 any open PCIe* slot		Switch → BP ports 0–3 Cable 1 Switch → BP ports 4–7 Cable 2 A2U8PSWCXCXK3	Left Left
		PCIe* SSD 2 (CR) → BP 6 (CV) 700mm – AXXCBL700CVCR				8-port PCIe* Switch Add-in Card AXXP3SWX08080 PCIe* slot #2	Switch → BP ports 0–3 Cable 1 Switch → BP ports 4–7 Cable 2 A2U8PSWCXCXK3	Left Left
		PCIe* SSD 3 (CR) → BP 7 (CV) 700mm – AXXCBL700CVCR					Switch → BP ports 0–3 Cable 1 Switch → BP ports 4–7 Cable 2 A2U8PSWCXCXK3	Left Left
		All cables routed left						

System Configuration	NVMe* Drive Support	Onboard PCIe* OCuLink to Drive Bay Module (BP) #1 Cable Kits	PCIe* Retimer Card Option on Riser #1 (NOT SUPPORTED¹)	PCIe* Retimer Card Option on Riser #2	PCIe* Retimer Card to Drive Bay Module (BP) #1 Cable Kits	Cable Routing
<p>Drive Bay #1</p> <p>R2208WF R2208WF +8 R2224WF</p>	<p>Up to Eight 2.5" NVMe* SSDs</p>	<p>PCIe* SSD 0 (CR) → BP 0 (CV) 470mm – AXXCBL470CVCR</p> <p>PCIe* SSD 1 (CR) → BP 1 (CV) 530mm – AXXCBL530CVCR</p> <p>PCIe* SSD 2 (CR) → BP 2 (CV) 600mm – AXXCBL600CVCR</p> <p>PCIe* SSD 3 (CR) → BP 3 (CV) 600mm – AXXCBL600CVCR</p> <p>PCIe* SSD 0 (CR) → BP 4 (CV) 600mm – AXXCBL600CVCR</p> <p>PCIe* SSD 1 (CR) → BP 5 (CV) 600mm – AXXCBL600CVCR</p> <p>PCIe* SSD 2 (CR) → BP 6 (CV) 600mm – AXXCBL600CVCR</p> <p>PCIe* SSD 3 (CR) → BP 7 (CV) 600mm – AXXCBL600CVCR</p> <p>All cables routed left</p>		<p>4-port PCIe* Retimer Add-in Card AXXP3RTX16040 top PCIe* slot #1</p>	<p>Retimer → BP ports 0–3 or Retimer → BP ports 4–7 A2U4PRTCXCXK</p>	<p>Left</p>

¹ PCIe* retimer card installed to Riser #1 is not supported.

4.7.2 2U – 8x2.5" Drive Bay Module #2 – Cable Guide (with no SAS Expander)



Drive Bay #2

4.7.2.1 Drive Bay Module #2 – SAS/SATA Cable Guide

The following table identifies the appropriate SATA/SAS data cable kit(s) necessary to route data signals from Onboard SATA ports or available SAS RAID mezzanine and PCIe* add-in options to the 8x2.5" backplane installed to **Drive Bay Module #2**.

Table 61. Drive bay module #2 SAS/SATA cable guide

System Configuration	Drive Support	SATA Onboard Multiport SATA Ports to Backplane (BP) #2	SAS Mezzanine 12 Gb SAS ROC Module to Backplane (BP) #2	SAS 12 Gb SAS RAID PCIe* Add-in Card to Backplane (BP) #2
Drive Bay #2 (no SAS Expander) R2208WF...+ 8 drive option R2224WF...	8 x 2.5" SATA – All Drives SAS – All Drives	SATA 0–3 → BP 0–3 730mm HD --- HD SATA 4–7 → BP 4–7 875mm HD --- HD From data above, select appropriate cable kits from list below : AXXCBL730HDHD (1) 730mm Included in all 2.5" L6 AXXCBL875HDHD (1) 875mm Included in R2224 L6	SAS Mezz → BP 0–3 730mm HD --- HD SAS Mezz → BP 4–7 875mm HD --- HD From data above, select appropriate cable kits from list below : AXXCBL730HDHD (1) 730mm Included in all 2.5" L6 AXXCBL875HDHD (1) 875mm Included in R2224 L6	From Riser #1: SAS PCIe* → BP 0–3 ¹ 650 or 730mm HD --- HD SAS PCIe* → BP 4–7 ¹ 730 or 800mm HD --- HD From Riser #2: SAS PCIe* → BP 0–3 ¹ 800 or 875mm HD --- HD SAS PCIe* → BP 4–7 ¹ 730 or 875mm HD --- HD From data above, select appropriate cable kits from list below : AXXCBL650HDHD AXXCBL730HDHD (2) 730mm Included in all 2.5" L6 AXXCBL800HDHD AXXCBL875HDHD (4) 875mm Included in R2224 L6

¹ 1 or 2 cable lengths may be specified for a PCIe* add-in card. Generally, if the cable connector of the add-in card is on the back edge of the card, a shorter cable is specified. Cable connectors on the top edge or near the front of the add-in card will require the longer cable length.

4.7.2.2 Drive Bay Module # 2 – NVMe* Cable Guide

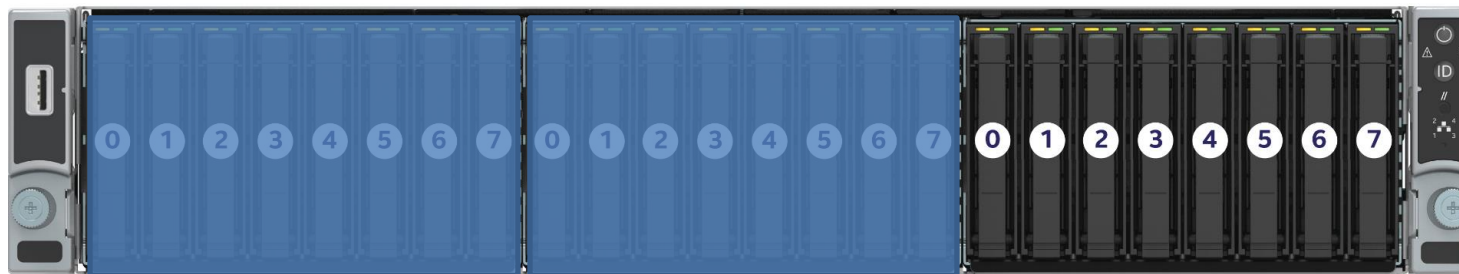
Table 62 identifies the appropriate PCIe* NVMe* data cable kit(s) necessary to route PCIe* signals from any of the onboard PCIe* OCuLink connectors and/or PCIe* switch add-in card options to the 8x2.5" combo backplane installed to **Drive Bay Module #2**. Select the cable kit or kits required to support the specific PCIe* source or sources and appropriate number of NVMe* drives being installed to **Drive Bay Module #2 only**.

Note: CR and CV refer to the connector types at each end of the PCIe* OCuLink cable. See Section 4.1.

Table 62. Drive bay module #2 NVMe* cable guide

System Configuration	NVMe* Drive Support	Onboard PCIe* OCuLink to Drive Bay Module (BP) #2 Cable Kits	PCIe* Switch Card Option on Riser #1	PCIe* Switch Card Option on Riser #2	PCIe* Switch Card Option on Riser #3	PCIe* Switch Card to Drive Bay Module (BP) #2 Cable Kits	Cable Routing	
Drive Bay #2 R2208WF + 8 R2224WF	Up to Eight 2.5" NVMe* SSDs	PCIe* SSD 0 (CR) → BP 0 (CV) 700mm – AXXCBL700CVCR Route Left	4-port PCIe* Switch Add-in Card AXXP3SWX08040 any open PCIe* slot			Switch → BP ports 0–3 Or Switch → BP ports 4–7 A2U4PSWCXCXK2	Left	
		PCIe* SSD 1 (CR) → BP 1 (CV) 700mm – AXXCBL700CVCR Route Left		4-port PCIe* Switch Add-in Card AXXP3SWX08040 any open PCIe* slot		Switch → BP ports 0–3 Or Switch → BP ports 4–7 A2U4PSWCXCXK2	Right	
		PCIe* SSD 2 (CR) → BP 2 (CV) 700mm – AXXCBL700CVCR Route Right			4-port PCIe* Switch Add-in Card AXXP3SWX08040 PCIe* slot #2	Switch → BP ports 0–3 Or Switch → BP ports 4–7 A2U4PSWCXCXK2	Right	
		PCIe* SSD 3 (CR) → BP 3 (CV) 700mm – AXXCBL700CVCR Route Right		8-port PCIe* Switch Add-in Card AXXP3SWX08080 any open PCIe* slot		Switch → BP ports 0–3 Cable 1 Switch → BP ports 4–7 Cable 2 A2U8PSWCXCXK2	Left	
		PCIe* SSD 0 (CR) → BP 4 (CV) 700mm – AXXCBL700CVCR Route Left			8-port PCIe* Switch Add-in Card AXXP3SWX08080 any open PCIe* slot	Switch → BP ports 0–3 Cable 1 Switch → BP ports 4–7 Cable 2 A2U8PSWCXCXK2	Right	
		PCIe* SSD 1 (CR) → BP 5 (CV) 700mm – AXXCBL700CVCR Route Left				8-port PCIe* Switch Add-in Card AXXP3SWX08080 PCIe* slot #2	Switch → BP ports 0–3 Cable 1 Switch → BP ports 4–7 Cable 2 A2U8PSWCXCXK3	Right
		PCIe* SSD 2 (CR) → BP 6 (CV) 700mm – AXXCBL700CVCR Route Right					Switch → BP ports 0–3 Cable 1 Switch → BP ports 4–7 Cable 2 A2U8PSWCXCXK3	Right
		PCIe* SSD 3 (CR) → BP 7 (CV) 700mm – AXXCBL700CVCR Route Right						Right

4.7.3 2U – 8x2.5" Drive Bay Module #3 – Cable Guide (with no SAS Expander)



Drive Bay #3

4.7.3.1 Drive Bay Module #3 – SAS/SATA Cable Guide

The following table identifies the appropriate SATA/SAS data cable kit(s) necessary to route data signals from onboard SATA ports or available SAS RAID mezzanine and PCIe* add-in options to the 8 x 2.5" backplane installed to **Drive Bay Module #3**.

Table 63. Drive bay module #3 SAS/SATA cable guide

System Configuration	Drive Support	Cables for Onboard Multiport SATA Ports to Drive Bay #3	Cables for Mezzanine 12 Gb SAS ROC Module to Drive Bay #3	Cables for 12 Gb SAS RAID PCIe* Add-in Card to Drive Bay #3
Drive Bay #3 (no SAS Expander) R2224WF...	8 x 2.5" SATA – All Drives SAS – All Drives NVMe* – All Drives	SATA 0–3 → BP 0–3 800mm HD --- HD SATA 4–7 → BP 4–7 730mm HD --- HD From data above, select appropriate cable kits from list below : AXXCBL730HDHD (2) 730mm cables Included in all 2.5" L6 AXXCBL800HDHD	SAS Mezz → BP 0–3 730mm HD --- HD SAS Mezz → BP 4–7 730mm HD --- HD From data above, select appropriate cable kits from list below : AXXCBL730HDHD (2) 730mm cables Included in all 2.5" L6)	From Riser #1: SAS PCIe* → BP 0–3 ¹ 730 or 875mm HD --- HD SAS PCIe* → BP 4–7 ¹ 800 or 950mm HD --- HD From Riser #2: SAS PCIe* → BP 0–3 ¹ 730 or 875mm HD --- HD SAS PCIe* → BP 4–7 ¹ 650 or 800mm HD --- HD From data above, select appropriate cable kits from list below : AXXCBL650HDHD AXXCBL730HDHD (2) 730mm Included in all 2.5" L6 AXXCBL800HDHD AXXCBL875HDHD (4) 875mm Included in R2224 L6 AXXCBL950HDHD

¹ 1 or 2 cable lengths may be specified for a PCIe* add-in card. Generally, if the cable connector of the add-in card is on the back edge of the card, a shorter cable is specified. Cable connectors on the top edge or near the front of the add-in card will require the longer cable length.

4.7.3.2 Drive Bay Module #3 – NVMe* Cable Guide

The following table identifies the appropriate PCIe* NVMe* data cable kit(s) necessary to route PCIe* signals from any of the onboard PCIe* OCuLink connectors and/or PCIe* switch add-in card options to the 8 x 2.5" combo backplane installed to **Drive Bay Module #3**.

Select the cable kit or kits required to support the specific PCIe* source or sources and the appropriate number of NVMe* drives being installed to **Drive Bay Module #3 only**.

Note: CR and CV refer to the connector types at each end of the PCIe* OCuLink cable. See Table 9.

Table 64. Drive bay module #3 NVMe* cable guide

System Configuration	NVMe* Drive Support	Onboard PCIe* OCuLink to Drive Bay Module (BP) #3 Cable Kits	PCIe* Switch Card Option on Riser #1	PCIe* Switch Card Option on Riser #2	PCIe* Switch Card Option on Riser #3	PCIe* Switch Card to Drive Bay Module (BP) #3 Cable Kits	Cable Routing	
Drive Bay #3 R2224WF...	Up to Eight 2.5" NVMe* SSDs	PCIe* SSD 0 (CR) → BP 0 (CV) 800mm – AXXCBL800CVCR	4-port PCIe* Switch Add-in Card AXXP3SWX08040 any open PCIe* slot			Switch → BP ports 0–3 Or Switch → BP ports 4–7 A2U4PSWCXCXK2	Right	
		PCIe* SSD 1 (CR) → BP 1 (CV) 800mm – AXXCBL800CVCR			4-port PCIe* Switch Add-in Card AXXP3SWX08040 any open PCIe* slot		Switch → BP ports 0–3 Or Switch → BP ports 4–7 A2U4PSWCXCXK1	Right
		PCIe* SSD 2 (CR) → BP 2 (CV) 600mm – AXXCBL600CVCR			4-port PCIe* Switch Add-in Card AXXP3SWX08040 PCIe* slot #2		Switch → BP ports 0–3 Or Switch → BP ports 4–7 A2U4PSWCXCXK1	Right
		PCIe* SSD 3 (CR) → BP 3 (CV) 600mm – AXXCBL600CVCR	8-port PCIe* Switch Add-in Card AXXP3SWX08080 any open PCIe* slot				Switch → BP ports 0–3 Cable 1 Switch → BP ports 4–7 Cable 2 A2U8PSWCXCXK2	Right
		PCIe* SSD 0 (CR) → BP 4 (CV) 800mm – AXXCBL800CVCR					Switch → BP ports 4–7 Cable 2 A2U8PSWCXCXK2	Right
		PCIe* SSD 1 (CR) → BP 5 (CV) 800mm – AXXCBL800CVCR		8-port PCIe* Switch Add-in Card AXXP3SWX08080 any open PCIe* slot			Switch → BP ports 0–3 Cable 1 Switch → BP ports 4–7 Cable 2 A2U8PSWCXCXK3	Right
		PCIe* SSD 2 (CR) → BP 6 (CV) 530mm – AXXCBL530CVCR					Switch → BP ports 0–3 Cable 1 Switch → BP ports 4–7 Cable 2 A2U8PSWCXCXK3	Right
		PCIe* SSD 3 (CR) → BP 7 (CV) 530mm – AXXCBL530CVCR				8-port PCIe* Switch Add-in Card AXXP3SWX08080 PCIe* slot #2	Switch → BP ports 0–3 Cable 1 Switch → BP ports 4–7 Cable 2 A2U8PSWCXCXK3	Right
		All cables routed Right					Right	

System Configuration	NVMe* Drive Support	Onboard PCIe* OCuLink to Drive Bay Module (BP) #1 Cable Kits	PCIe* Retimer Card Option on Riser #1 (NOT SUPPORTED¹)	PCIe* Retimer Card Option on Riser #2	PCIe* Retimer Card to Drive Bay Module (BP) #3 Cable Kits	Cable Routing
<p>Drive Bay #3</p> <p>R2224WF...</p>	<p>Up to Eight 2.5" NVMe* SSDs</p>	<p>PCIe* SSD 0 (CR) → BP 0 (CV) 800mm – AXXCBL800CVCR</p> <p>PCIe* SSD 1 (CR) → BP 1 (CV) 800mm – AXXCBL800CVCR</p> <p>PCIe* SSD 2 (CR) → BP 2 (CV) 600mm – AXXCBL600CVCR</p> <p>PCIe* SSD 3 (CR) → BP 3 (CV) 600mm – AXXCBL600CVCR</p> <p>PCIe* SSD 0 (CR) → BP 4 (CV) 800mm – AXXCBL800CVCR</p> <p>PCIe* SSD 1 (CR) → BP 5 (CV) 800mm – AXXCBL800CVCR</p> <p>PCIe* SSD 2 (CR) → BP 6 (CV) 530mm – AXXCBL530CVCR</p> <p>PCIe* SSD 3 (CR) → BP 7 (CV) 530mm – AXXCBL530CVCR</p> <p>All cables routed Right</p>	<p>PCIe* Retimer Card Option on Riser #1 (NOT SUPPORTED¹)</p>	<p>4-port PCIe* Retimer Add-in Card</p> <p>AXXP3RTX16040</p> <p>top PCIe* slot #1</p>	<p>Retimer → BP ports 0–3 or Retimer → BP ports 4–7</p> <p>A2U4PRTCXCXK</p>	<p>Right</p>

¹ PCIe* retimer card installed to Riser #1 is not supported.

4.7.4 2U 2.5" Front Mount Drive Configurations – Cable Guide (with SAS Expander)

Server configurations consisting of 8 drive configurations requiring SAS support are recommended to use an 8-port SAS controller. For 12 and 16 drive configurations, Intel recommends a 16-port SAS controller. While for 24 drive configurations, Intel recommends an 8-port SAS controller paired with the RES3TV360 SAS expander. In the 2U 16x2.5" or 24x2.5" system configurations, a SAS expander can be mounted in the area directly behind the drive bays.

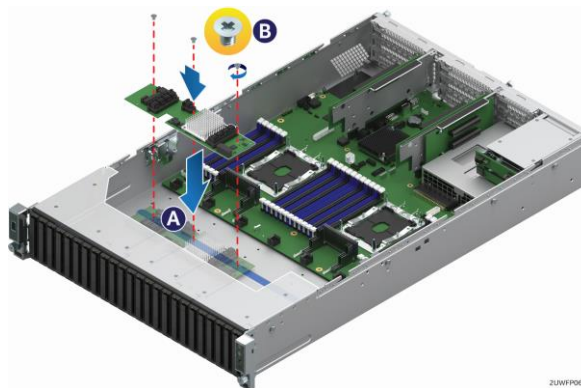



Figure 29. SAS expander module identification and placement

Intel provides the following SAS expander option to support these drive configurations:

Table 65. SAS expander option

Image	Details	Description
	<p>SAS 3.0 12 Gb/s Expander</p> <p>iPC RES3TV360 MM# 932894 UPC 00735858287364 EAN 5032037067102 MOQ 5</p> <p>Product type 2U accessory kit</p>	<ul style="list-style-type: none"> • 6Gbps data aggregation for 12Gbps data transfer with 6Gb/s devices • Internal mount mid-plane form factor • 36 internal ports supporting point-to-point 12, 6, and 3 Gb/s data transfer rates • RA 4-pin power connector • HD Mini-SAS 8643 Connectors <p>Kit includes: (1) SAS expander card; (1) 130mm Power cable; (1 set) Expander-to-backplane cables: (4) HD-HD 165mm, (1) HD-HD 300mm, (1) HD-HD 250mm; (3) Rubber Pads; mounting screws</p> <p>Required (sold separately)</p> <ul style="list-style-type: none"> • HD-HD 12 Gb/sec Raid Controller-to-Expander cables – See Chapter 4

Note: The onboard SATA ports are not compatible with SAS expander cards. The onboard SATA ports must be cabled directly to a specified backplane.

Table 66. Front mount drive cable guide

4 or 8-port Mezzanine 12Gb SAS ROC Module to 12 Gb SAS Expander	4 or 8-port 12Gb SAS RAID PCIe* Add-in Card to 12 Gb SAS Expander
<p>12 Gb SAS Expander RES3TV360 installed:</p> <p>SAS Mezz → Exp 0–3 (G) 730mm HD --- HD</p> <p>SAS Mezz → Exp 4–7 (H) 730mm HD --- HD</p> <p>From data above, select appropriate cable kits from list below:</p> <p>AXXCBL730HDHD (2) 730mm cables Included in all 2.5" L6 systems</p>	<p>12 Gb SAS Expander RES3TV360 installed:</p> <p>From Riser #1:</p> <p>SAS PCIe* → Exp 0–3 (G) 650mm HD --- HD</p> <p>SAS PCIe* → Exp 4–7 (H) 650mm HD --- HD</p> <p>From Riser #2:</p> <p>SAS PCIe* → Exp 0–3 (G) 730mm HD --- HD</p> <p>SAS PCIe* → Exp 4–7 (H) 730mm HD --- HD</p> <p>From data above, select appropriate cable kits from list below:</p> <p>AXXCBL650HDHD AXXCBL730HDHD (2) 730mm cables Included in all 2.5" L6 systems</p>
<p>12 Gb SAS Expander to drive bays</p>	<p>12 Gb SAS Expander to drive bays</p>
<p>Use cables included in SAS Expander Kit</p>	<p>Use cables included in SAS Expander Kit</p>

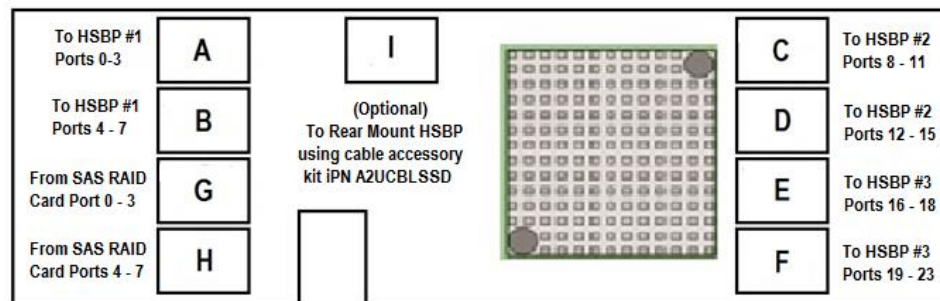


Figure 30. SAS expander port mapping

5. 1U/2U System Optional Accessories

The following sections identify available accessory kits supported within the Intel® Server S2600WF product family.

5.1 2U Rear Mount Hot Swap Drive Bay Accessory Kits

The 2U product family provides the option to support two 2.5" 6 Gb/s hot-swap SSDs installed to a modular drive bay mounted in the back of the system.

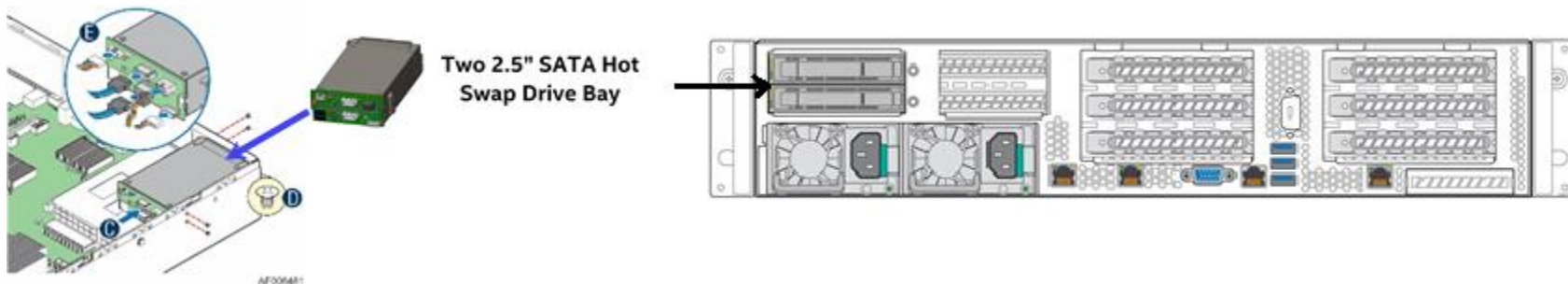




Figure 31. 2U rear-mount hot-swap drive bay accessory

Table 67. 2U rear-mount hot-swap drive bay accessory kits

Image	Details	Description
	<p>2U Rear Mount Hot Swap Drive Bay Accessory Kit</p> <p>iPC A2UREARHSDK2 MM# 958243 UPC 00735858344876 EAN 5032037105583 MOQ 1</p> <p>Product type 2U accessory kit, Building block</p>	<p>Kit Includes:</p> <ul style="list-style-type: none"> (1) Drive Bay Assembly and mounting hardware (2) 2.5" Hot Swap Drive Carriers (2) SATA Data Cables (1) Power Cable (1) I2C Cable (1) SGPIO cable
	<p>2U Fixed Mount SSD and Rear Drive Bay Cable Kit</p> <p>iPC A2UCBLSSD MM# 937328 UPC 735858287005 EAN 5032037066747 MOQ 1</p> <p>Product type 2U cable kit</p>	<p>This kit includes cables to provide simultaneous support for up to two internal fixed mount SATA SSDs and rear drive bay.</p> <p>Kit includes:</p> <ul style="list-style-type: none"> (1) Power Cable – Connectors to support rear drive bay and 2 internal mount SSDs (No CD/DVD Drive support) (1) Fan out multiport SATA Data cable – Cable connectors include (1) HD mini-SAS SFF8643 + (4) 7-pin SATA + (1) SGPIO

5.2 1U/2U PCIe* Riser Card Accessory/Spare FRU Options


Each of the server board options within the Intel® Server S2600WF product family provides three riser slots. Riser slots #1 and #2 can support different riser card options to meet needs of specific system configurations. Riser card options for riser slots #1 and #2 are common. Riser slot 3 is only supported in 2U system configurations and can only support a riser capable of supporting low profile PCIe* add-in cards.

All PCIe* bus lanes to the riser slots are routed from the processors. Riser slot 1 has a total of 24 PCIe* 3.0 bus lanes routed from both processors: 16 lanes from processor #1 and 8 lanes from processor #2. Riser slot #2 has a total of 24 PCIe* 3.0 bus lanes routed from CPU 2. Riser slot #3 has a total of 12 PCIe* 3.0 bus lanes routed from CPU 2. See the product Technical Product Specifications (TPS) for additional information.

Riser slots #1 and #2 can support up to 75W maximum power each. Available power to each add-in card slot on a given riser card is defined by the PCIe* specification. The server board provides two auxiliary 12V power connectors that when cabled (iPC **AXXGPGPUCABLE**), can provide additional power to high power PCIe* add-in cards.

5.2.1 1U Riser Card Options

Table 68. 1U riser card option




Image	Details	Description
	<p>1U 1-Slot PCIe* Riser Card</p> <p>iPC F1UL16RISER3 MM# 958249 UPC 00735858345682 EAN 5032037106177 MOQ 1</p> <p>Product type 1U building block/spare FRU 1U accessory kit</p>	<p>One PCIe* add-in card slot – PCIe* x16, x16 mechanical</p> <p>Kit includes: (1) Riser card PCBA</p>

Each riser card assembly has support for a single full height, ½ length PCIe* add-in card. However, riser card #2 may be limited to ½ length, ½ height add-in cards if either of the two mini-SAS HD connectors on the server board are used.

Note: Add-in cards that exceed the PCI specification for ½ length PCI add-in cards (167.65mm or 6.6in) may interfere with other installed devices on the server board.

5.2.2 2U Riser Card Options

Table 69. 2U riser card options

Image	Details	Description
	<p>2U 3-Slot PCIe* Riser Card</p> <p>iPC A2UL8RISER2 MM# 934885 UPC 00735858288675 EAN 5032037067959 MOQ 1</p> <p>Product type 2U building block/spare FRU 2U accessory kit</p>	<p>Riser card option for riser slots #1 and #2.</p> <p>Each three-slot riser card assembly has support for up to two full height full length add-in cards (top and middle slots) and one full height ½ length add-in card (bottom slot).</p> <ul style="list-style-type: none"> Slot 1 (top) – PCIe* x8 elec, x16 mechanical Slot 2 (middle) – PCIe* x8 elec, x16 mechanical Slot 3 (bottom) – PCIe* x8 elec, x8 mechanical <p>Kit includes: (1) riser card PCBA</p>
	<p>2U 2-Slot PCIe* Riser Card</p> <p>iPC A2UL16RISER2 MM# 934886 UPC 00735858288668 EAN 5032037067942 MOQ 1</p> <p>Product type 2U building block/spare FRU 2U accessory kit</p>	<p>Riser card option for riser slots #1 and #2. Required for Intel® Xeon Phi™ coprocessor or high power PCIe* add-in card support.</p> <p>Each two-slot riser card assembly has support for one full-height full-length add-in card (top slot) and one full-height half-length add-in card (bottom slot).</p> <ul style="list-style-type: none"> Slot 1 (top) – PCIe* x16 elec, x16 mechanical Slot 2 (bottom) – PCIe* x8 elec, x8 mechanical <p>Kit includes: (1) Riser card PCBA (1) 12 V AUX power cable (to provide additional 12 V power for high power PCIe* add-in cards that require it)</p>
	<p>2U 2-Slot Short Riser Card</p> <p>iPC A2UX8X4RISER MM# 934883 UPC 00735858283311 EAN 5032037064378 MOQ 1</p> <p>Product type 2U building block/spare FRU 2U accessory kit</p>	<p>Riser card option for riser slot #3 only.</p> <p>Provided to support up to two additional PCIe* add-in card slots for 2U server configurations. The available riser card option is designed to support low profile add-in cards only.</p> <ul style="list-style-type: none"> Slot 1 (top) – PCIe* x4 elec, x8 mechanical Slot 2 (bottom) – PCIe* x8 elec, x8 mechanical <p>Kit includes: (1) Riser card PCBA</p>

5.3 2U 8x2.5" Drive Bay Module Options

2U system configurations that include support for 2.5" front mount storage devices can support up to three 8x2.5" drive bay modules. Intel makes available different types of 8x2.5" drive bay modules and can support from one to three of the same module or a mix of different modules.

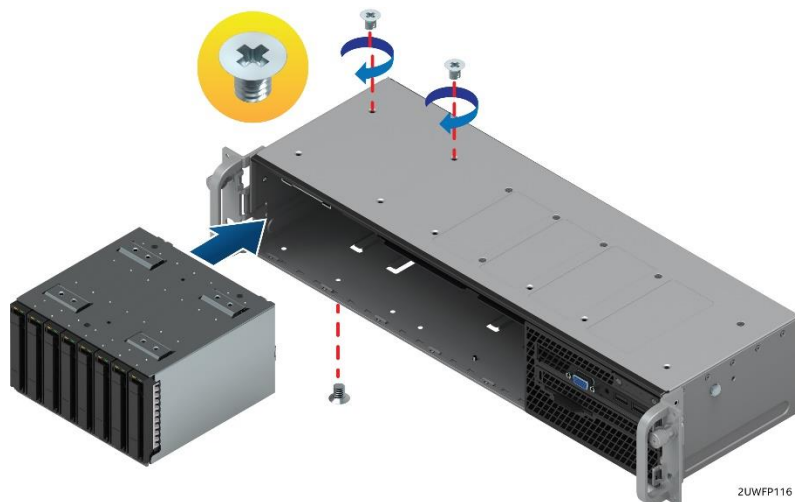


Figure 32. R2208WF based system with front I/O module bay assembly




Figure 33. 2U 2.5" drive identification for each drive bay

Drive numbering in the illustrations above is for general reference only. Actual drive numbering is dependent on SAS/SATA/NVMe* controller configuration and how they are cabled to the backplane. Each drive bay will include a single backplane. Each backplane will include a multiport data connector for each set of four drives. Ex) for an 8 drive configuration, the backplane will include 2 four port data connectors. In the illustration above, drives showing a common Drive ID label color share a common data connector on the backside of the given backplane.

R2208WF (8x2.5" – 1 drive bay) and **R2208WF + 8 drive bay module** (16x2.5" – 2 drive bays) system configurations use the same front I/O module bay assembly containing the System Control Panel and Front I/O Panel (shown in Figure 14). When upgrading a R2208WF based system to a 16 drive based system, all that is needed is the removal of the Bay #2 face plate to insert the new drive bay and adding the required data cables. No other chassis changes or additions are required.

Available 8x2.5" drive bay module accessory kits are listed in Table 70.

Table 70. 8x2.5" drive bay module accessory kits

Image	Details	Description
	<p>2U Hot-Swap 8 x 2.5" SAS/NVMe* Combo Drive Bay Kit</p> <p>iPC A2U8X25S3PHS MM# 955858 UPC 00735858344852 EAN 5032037105569 MOQ 1</p> <p>Product type 2U drive upgrade kit 2U building block</p>	<p>8x2.5" SAS/NVMe* Combo Front Mount Hot Swap Drive Bay Module for all 2U 2.5" systems.</p> <p>Kit includes:</p> <ul style="list-style-type: none"> (1) Drive bay assembly module (1) 8x2.5 SAS/NVMe* combo backplane (8) 2.5" drive carriers and drive blanks (1) 75mm 6pin – 6pin I2C jumper cable (1) 75mm 5pin-6pin I2C jumper cable <p>Required (sold separately):</p> <ul style="list-style-type: none"> SAS/SATA data cables – See Chapter 4 PCIe* OCuLink cables – See Chapter 4

5.4 Intel® Ethernet Network Adapters for OCP*

The Intel® S2600WF product family includes support for a number of optional OCP* modules that install onto proprietary connectors on the server board leaving all available PCIe* add-in cards slots available for other add-in card options.

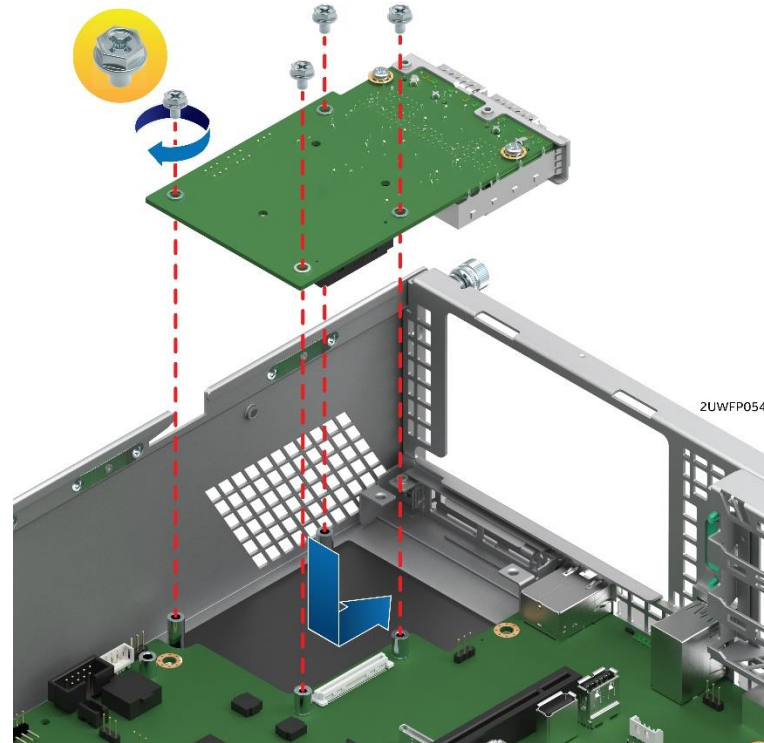
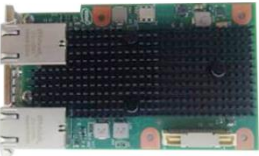

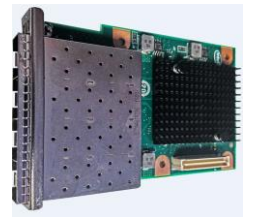



Figure 34. Intel® Ethernet Network Adapter for OCP* installation

Table 71. Intel® Ethernet Network Adapters for OCP*

Image	Details	Description
	<p>Intel® Ethernet Network Connection OCP* X557-T2</p> <p>iPC X557T2OCPG1P5 MM# 950179 UPC 00735858328821 EAN 5032037095020 MOQ 1</p> <p>Product type 1U/2U accessory kit</p>	<p>Dual Port 10GbE RJ45 OCP* Module OCP PHY Mezzanine Type1/Type 2 AIC 2 x 10GBASE-T uplinks 2 x KR host connections via OCP PHY Mezzanine Connector C</p>
	<p>Intel® Ethernet Network Connection OCP* X527-DA2</p> <p>iPC X527DA2OCPG1P5 MM# 950126 UPC 00735858328845 EAN 5032037095044 MOQ 1</p> <p>Product type 1U/2U accessory kit</p>	<p>Dual port 10GbE SFP+ OCP* Module OCP PHY Mezzanine Type1/Type 2 AIC 2 x SFP+ uplinks 2 x KR host connections via OCP PHY Mezzanine Connector C</p>
	<p>Intel® Ethernet Network Connection OCP* X527-DA4</p> <p>iPC X527DA4OCPG1P5 MM# 950127 UPC 00735858328852 EAN 5032037095051 MOQ 1</p> <p>Product type 1U/2U accessory kit</p>	<p>Quad port 10GbE SFP+ OCP* Module OCP PHY Mezzanine Type1/Type 2 AIC 4 x SFP+ uplinks 4 x KR host connections via OCP PHY Mezzanine Connector C</p> <ul style="list-style-type: none"> • Only available for S2600WF0 and S2600WFQ
	<p>Intel® Ethernet Network Connection OCP* I357-T4</p> <p>iPC I357T4OCPG1P5 MM# 948352 UPC 00735858328869 EAN 5032037095068 MOQ 1</p> <p>Product type 1U/2U accessory kit</p>	<p>Quad Port 1GbE RJ45 OCP* Module OCP PHY Mezzanine Type1/Type 2 AIC 4 x 1GBASE-T uplinks 4 x SGMII host connections via OCP PHY Mezzanine Connector C</p> <ul style="list-style-type: none"> • Only available for S2600WF0 and S2600WFQ

5.5 Intel® RAID Add-in Cards, Modules, and Accessories

Intel® RAID offers a broad portfolio of RAID solutions designed to address the storage-related challenges of the modern day data center as well as the small business. The Intel® S2600WF product family includes support for the latest generation of 12 Gb/s SAS Intel® RAID add-in cards, modules, expanders, and accessories. For a full list of validated Intel® RAID cards, see the published Tested Hardware and Operating System List at <http://www.intel.com/support>.

Additional information for Intel® RAID products can be found in the following documents:

- <https://www.intel.com/content/dam/www/public/us/en/documents/product-briefs/integrated-raid-module-rms3-family-brief.pdf>
- <https://www.intel.com/content/dam/www/public/us/en/documents/product-briefs/raid-matrix.pdf>

Table 72. Intel® Integrated RAID module RMS3 product family – SAS 3.0 (12 Gb/s)



Image	Details	Description
	<p>Intel® Integrated RAID Module RMS3CC080</p> <p>iPC RMS3CC080 MM# 932474 UPC 00735858276832 EAN 5032037060448 MOQ 5</p> <p>Product type 1U/2U accessory kit</p>	<p>SAS 3.0 (12 Gb/s) Mezzanine Form Factor HW RAID Module 8 internal SAS / SATA ports Mini-SAS HD SFF8643 connectors LSI* SAS3108 ROC with 1GB DDR3 RAID Levels 0, 1, 5, 6, 10, 50, 60 Embedded 1GB DDR3 Cache Memory Supports Maintenance Free Backup Unit – iPC AXXRMFBU5 Supports the following Intel® RAID Accessory Options:</p> <ul style="list-style-type: none"> • Intel® RAID SSD Cache with Fast Path I/O – iPC AXXRPFKSSD2 • Intel® RAID Drive Encryption Management – iPC AXXRPFKDE2 • Intel® RAID Rapid Recovery Snapshot – iPC AXXRPFKSNSH2 <p>SAS data cables not included and must be purchased separately.</p>
	<p>Intel® Integrated RAID Module RMS3CC040</p> <p>iPC RMS3CC040 MM# 932473 UPC 00735858276849 EAN 5032037060455 MOQ 5</p> <p>Product type 1U/2U accessory kit</p>	<p>SAS 3.0 (12 Gb/s) Mezzanine Form Factor HW RAID Module 4 internal SAS / SATA ports Mini-SAS HD SFF8643 connectors LSI* SAS3108 ROC with 1GB DDR3 RAID Levels 0, 1, 5, 6, 10, 50, 60 Embedded 1GB DDR3 Cache Memory Supports Maintenance Free Backup Unit – iPC AXXRMFBU5 Supports the following Intel® RAID Accessory Options:</p> <ul style="list-style-type: none"> • Intel® RAID SSD Cache with Fast Path I/O – iPC AXXRPFKSSD2 • Intel® RAID Drive Encryption Management – iPC AXXRPFKDE2 • Intel® RAID Rapid Recovery Snapshot – iPC AXXRPFKSNSH2 <p>SAS data cables not included and must be purchased separately.</p>





Image	Details	Description
	<p>Intel® Integrated RAID Module RMS3HC080</p> <p>iPC RMS3HC080 MM# 932469 UPC 00735858276818 EAN 5032037060424 MOQ 5</p> <p>Product type 1U/2U accessory kit</p>	<p>SAS 3.0 (12 Gb/s) Mezzanine Form Factor Entry-RAID Module 8 internal SAS / SATA ports Mini-SAS HD SFF8643 connectors LSI* SAS3008 SAS IOC with Advanced Management Entry hardware RAID levels – JBOD, RAID 0,1,10 and Hybrid 5,50 128MB server board memory used as cache memory for RAID 5/50</p> <p>SAS data cables not included and must be purchased separately.</p>
	<p>Intel® Integrated RAID Module RMS3JC080</p> <p>iPC RMS3JC080 MM# 932472 UPC 00735858276825 EAN 5032037060431 MOQ 5</p> <p>Product type 1U/2U accessory kit</p>	<p>SAS 3.0 (12 Gb/s) Mezzanine Form Factor Entry-RAID Module 8 internal SAS / SATA ports Mini-SAS HD SFF8643 connectors LSI* SAS3008 IOC with Basic Firmware Entry hardware RAID levels – JBOD, RAID 0, 1, 1E, 10</p> <p>SAS data cables not included and must be purchased separately.</p>
	<p>Intel® Integrated RAID Module RMS3VC160</p> <p>iPC RMS3VC160 MM# 946902 UPC 00735858308595 EAN 5032037081351 MOQ 5</p> <p>Product type 1U/2U accessory kit</p>	<p>Mezzanine Form Factor RAID Module Entry Level SAS RAID Controller 16 internal SAS / SATA ports Avago* SAS3216 IOC RAID Levels – JBOD (SAS/SATA Connectivity)</p> <p>SAS data cables not included and must be purchased separately.</p>
	<p>Intel® Integrated RAID Module RMS3AC160</p> <p>iPC RMS3AC160 MM# 947032 UPC 00735858308571 EAN 5032037081337 MOQ 5</p> <p>Product type 1U/2U accessory kit</p>	<p>Mezzanine Form Factor RAID Module Full Featured SAS RAID Controller 16 internal SAS / SATA ports Avago* SAS3316 IOC RAID Levels – 0, 1, 5, 6, 10, 50, and 60 Supports Maintenance Free Backup Unit – iPC AXXRMFBU6</p> <p>SAS data cables not included and must be purchased separately.</p>











Image	Details	Description
	<p>Intel® Integrated RAID Module RMSP3JD160J</p> <p>iPC RMSP3JD160J MM# 954490 UPC 00735858329118 EAN 5032037095235 MOQ 5</p> <p>Product type 1U/2U accessory kit</p>	<p>Mezzanine Form Factor RAID Module Entry Level SAS RAID Controller 16 internal SAS / SATA ports / 4NVMe Avago* SAS3516 IOC RAID Levels – JBOD (SAS/SATA/NVMe* Connectivity) SAS and NVMe* data cables not included and must be purchased separately.</p>
	<p>Intel® Integrated RAID Module RMSP3HD080E</p> <p>iPC RMSP3HD080E MM# 954553 UPC 00735858329125 EAN 5032037095242 MOQ 5</p> <p>Product type 1U/2U accessory kit</p>	<p>Mezzanine Form Factor RAID Module Entry level Tri-Mode RAID Module 8 internal SAS / SATA ports / 2 NVMe Avago* SAS3508 IOC RAID Levels – 0/1/10/5 and JBOD</p> <p>SAS and NVMe* data cables not included and must be purchased separately.</p>
	<p>Intel® Integrated RAID Module RMSP3AD160F</p> <p>iPC RMSP3AD160F MM# 954552 UPC 00735858329149 EAN 5032037095266 MOQ 5</p> <p>Product type 1U/2U accessory kit</p>	<p>Mezzanine Form Factor RAID Module Full Featured Tri-Mode RAID Controller 16 internal SAS / SATA ports / 4 NVMe Avago* SAS3516 ROC RAID Levels – 0/1/10/5/6/50/60 and JBOD Supports Maintenance Free Backup Unit – iPC AXXRMFBU7 Supports the following Intel® RAID Accessory Options:</p> <ul style="list-style-type: none"> • Intel® RAID Drive Encryption Management – iPC AXXRPFKDE2 <p>SAS and NVMe* data cables not included and must be purchased separately.</p>
	<p>Intel® Integrated RAID Module RMSP3CD080F</p> <p>iPC RMSP3CD080F MM# 954489 UPC 00735858329132 EAN 5032037095259 MOQ 5</p> <p>Product type 1U/2U accessory kit</p>	<p>Mezzanine Form Factor RAID Module Full Featured Tri-Mode RAID Controller 8 internal SAS / SATA ports / 2 NVMe Avago* SAS3508 ROC RAID Levels – 0/1/10/5/6/50/60 and JBOD Supports Maintenance Free Backup Unit – iPC AXXRMFBU7 Supports the following Intel® RAID Accessory Options:</p> <ul style="list-style-type: none"> • Intel® RAID Drive Encryption Management – iPC AXXRPFKDE2 <p>SAS and NVMe* data cables not included and must be purchased separately.</p>

Table 73. Intel® RAID controller add-in cards – SAS 3.0 (12 Gb/s)

Image	Details	Description
	<p>Intel® RAID Controller RS3DC080</p> <p>iPC RS3DC080 MM# 934643 UPC 00735858265355 EAN 5032037107174 MOQ 5</p> <p>Product type 1U/2U accessory kit</p>	<p>Low Profile, half length, (MD2 Compliant) PCIe* add-in card 8 internal SAS / SATA ports LSI* SAS3108 ROC RAID Levels – 0, 1, 5, 6, 10, 50, and 60 Embedded 1GB DDR3 Cache Memory Supports Maintenance Free Backup Unit – iPC AXXRMFBU4 Supports the following Intel® RAID Accessory Options:</p> <ul style="list-style-type: none"> • Intel® RAID High Availability Activation Key – iPC AXXRPFKHA2 • Intel® RAID SSD Cache with Fast Path I/O – iPC AXXRPFKSSD2 • Intel® RAID Drive Encryption Management – iPC AXXRPFKDE2 • Intel® RAID Rapid Recovery Snapshot – iPC AXXRPFKSNSH2 <p>SAS data cables not included and must be purchased separately.</p>
	<p>Intel® RAID Controller RS3DC040</p> <p>iPC RS3DC040 MM# 934644 UPC 00735858265362 EAN 5032037107167 MOQ 5</p> <p>Product type 1U/2U accessory kit</p>	<p>Low Profile, half length, (MD2 Compliant) PCIe* add-in card 4 internal SAS / SATA ports LSI* SAS3108 ROC RAID Levels – 0, 1, 5, 6, 10, 50, and 60 Embedded 1GB DDR3 Cache Memory Supports Maintenance Free Backup Unit – iPC AXXRMFBU4 Supports the following Intel® RAID Accessory Options:</p> <ul style="list-style-type: none"> • Intel® RAID SSD Cache with Fast Path I/O – iPC AXXRPFKSSD2 • Intel® RAID Drive Encryption Management – iPC AXXRPFKDE2 • Intel® RAID Rapid Recovery Snapshot – iPC AXXRPFKSNSH2 <p>SAS data cables not included and must be purchased separately.</p>
	<p>Intel® RAID Controller RS3SC008</p> <p>iPC RS3SC008 MM# 928223 UPC 00735858266956 EAN 5032037068567 MOQ 5</p> <p>Product type 1U/2U accessory kit</p>	<p>Low Profile, half length, (MD2 Compliant) PCIe* add-in card 8 external SAS / SATA ports LSI* SAS3108 ROC RAID Levels – 0, 1, 5, 6, 10, 50, and 60 Embedded 1GB DDR3 Cache Memory Supports Maintenance Free Backup Unit – iPC AXXRMFBU4 Supports the following Intel® RAID Accessory Options:</p> <ul style="list-style-type: none"> • Intel® RAID High Availability Activation Key – iPC AXXRPFKHA2 • Intel® RAID SSD Cache with Fast Path I/O – iPC AXXRPFKSSD2 • Intel® RAID Drive Encryption Management – iPC AXXRPFKDE2 • Intel® RAID Rapid Recovery Snapshot – iPC AXXRPFKSNSH2 <p>SAS data cables not included and must be purchased separately.</p>

Intel® Server S2600WF Product Family Configuration Guide

Image	Details	Description
	<p>Intel® RAID Controller RS3GC008</p> <p>iPC RS3GC008 MM# 928220 UPC 00735858267175 EAN 5032037053839 MOQ 5</p> <p>Product type 1U/2U accessory kit</p>	<p>Low Profile, half length, (MD2 Compliant) PCIe* add-in card Entry Level SAS Card 8 external SAS / SATA ports LSI* SAS3008 IOC RAID Levels – JBOD (SAS/SATA Connectivity)</p> <p>SAS data cables not included and must be purchased separately.</p>
	<p>Intel® RAID Controller RS3UC080</p> <p>iPC RS3UC080 MM# 928218 UPC 00735858267649 EAN 5032037053938 MOQ 5</p> <p>Product type 1U/2U accessory kit</p>	<p>Low Profile, half length, (MD2 Compliant) PCIe* add-in card Entry Level SAS RAID Card 8 internal SAS / SATA ports LSI* SAS3008 IOC RAID Levels – 0, 1, 1E, 10, and JBOD</p> <p>SAS data cables not included and must be purchased separately.</p>
	<p>Intel® RAID Controller RS3WC080</p> <p>iPC RS3WC080 MM# 928215 UPC 00735858267656 EAN 5032037053945 MOQ 5</p> <p>Product type 1U/2U accessory kit</p>	<p>Low Profile, half length, (MD2 Compliant) PCIe* add-in card Entry Level SAS RAID Controller 8 internal SAS / SATA ports LSI* SAS3008 IOC RAID Levels – JBOD, 0, 1, 10 & Hybrid 5, 50</p> <p>SAS data cables not included and must be purchased separately.</p>
	<p>Intel® RAID Controller RS3UC080J</p> <p>iPC RS3UC080J MM# 952709 UPC 00735858323840 EAN 5032037090971 MOQ 5</p> <p>Product type 1U/2U accessory kit</p>	<p>Low Profile, half length, (MD2 Compliant) PCIe* add-in card Entry Level SAS RAID Controller 8 internal SAS / SATA ports LSI* SAS3008 IOC RAID Levels – JBOD (SAS/SATA Connectivity)</p> <p>SAS data cables not included and must be purchased separately.</p>

Intel® Server S2600WF Product Family Configuration Guide





Image	Details	Description
	<p>Intel® RAID Controller RSP3QD160J</p> <p>iPC RSP3QD160J MM# 954491 UPC 00735858329101 EAN 5032037095228 MOQ 5</p> <p>Product type 1U/2U accessory kit</p>	<p>Low Profile, half length, (MD2 Compliant) PCIe* add-in card Entry level Tri-Mode SAS/SATA/NVMe* adapter. 16 internal SAS / SATA ports / 4 NVMe LSI* SAS3416 IOC RAID Levels – JBOD (SAS/SATA/NVMe* Connectivity)</p> <p>SAS and NVMe* data cables not included and must be purchased separately.</p>
	<p>Intel® RAID Controller RSP3GD016J</p> <p>iPC RSP3GD016J MM# 954492 UPC 00735858329156 EAN 5032037095273 MOQ 5</p> <p>Product type 1U/2U accessory kit</p>	<p>Low Profile, half length, (MD2 Compliant) PCIe* add-in card Entry level Tri-Mode SAS/SATA/NVMe* adapter. 16 external SAS / SATA ports / 4 NVMe LSI* SAS3416 IOC RAID Levels – JBOD (SAS/SATA/NVMe* Connectivity)</p> <p>SAS and NVMe* data cables not included and must be purchased separately.</p>
	<p>Intel® RAID Controller RSP3WD080E</p> <p>iPC RSP3WD080E MM# 954495 UPC 00735858329170 EAN 5032037095297 MOQ 5</p> <p>Product type 1U/2U accessory kit</p>	<p>Low Profile, half length, (MD2 Compliant) PCIe* add-in card Entry level Tri-Mode RAID Controller 8 internal SAS / SATA ports/2 NVMe Avago* SAS3408 IOC RAID Levels – 0/1/10/5 and JBOD</p> <p>SAS and NVMe* data cables not included and must be purchased separately.</p>
	<p>Intel® RAID Controller RSP3TD160F</p> <p>iPC RSP3TD160F MM# 954493 UPC 00735858329163 EAN 5032037095280 MOQ 5</p> <p>Product type 1U/2U accessory kit</p>	<p>Low Profile, half length, (MD2 Compliant) PCIe* add-in card Full Featured Tri-Mode RAID Controller 16 internal SAS / SATA ports / 4 NVMe Avago* SAS3516 ROC RAID Levels – 0/1/10/5/6/50/60 and JBOD Supports Maintenance Free Backup Unit – iPC AXXRMFBU7</p> <p>SAS and NVMe* data cables not included and must be purchased separately.</p>




Image	Details	Description
	<p>Intel® RAID Controller RSP3DD080F</p> <p>iPC RSP3DD080F MM# 954496 UPC 00735858329187 EAN 5032037095303 MOQ 5</p> <p>Product type 1U/2U accessory kit</p>	<p>Low Profile, half length, (MD2 Compliant) PCIe* add-in card Full Featured Tri-Mode RAID Controller 8 internal SAS / SATA ports / 2 NVMe Avago* SAS3508 ROC RAID Levels – 0/1/10/5/6/50/60 and JBOD Supports Maintenance Free Backup Unit – iPC AXXRMFBU7 Supports the following Intel® RAID Accessory Options:</p> <ul style="list-style-type: none"> • Intel® RAID Drive Encryption Management – iPC AXXRPFKDE2 <p>SAS and NVMe* data cables not included and must be purchased separately.</p>
	<p>Intel® RAID Controller RSP3MD088F</p> <p>iPC RSP3MD088F MM# 954551 UPC 00735858329194 EAN 5032037095310 MOQ 5</p> <p>Product type 1U/2U accessory kit</p>	<p>Low Profile, half length, (MD2 Compliant) PCIe* add-in card Full Featured Tri-Mode RAID Controller 8 internal + 8 external SAS / SATA ports / 4 NVMe* Avago* SAS3516 ROC RAID Levels – 0/1/10/5/6/50/60 and JBOD Supports Maintenance Free Backup Unit – iPC AXXRMFBU7 Supports the following Intel® RAID Accessory Options:</p> <ul style="list-style-type: none"> • Intel® RAID Drive Encryption Management – iPC AXXRPFKDE2 <p>SAS and NVMe* data cables not included and must be purchased separately.</p>
	<p>Intel® Storage Adapter RS3P4QF160J</p> <p>iPC RS3P4QF160J MM# 999RKM UPC 00735858452830 EAN 5032037193115 MOQ 5</p> <p>Product type 1U/2U accessory kit</p>	<p>Low Profile, half length, (MD2 Compliant) PCIe* add-in card Entry level Tri-Mode SAS / SATA adapter 16 internal SAS / SATA ports Broadcom* SAS3816 IOC JBOD (SAS / SATA connectivity)</p> <p>SAS data cables are not included and must be purchased separately.</p> <p>Note: This card is PCIe* 4.0, however, it runs at the highest PCIe* standard supported by the server board (PCIe* 3.0). Note: This card was validated only for SAS / SATA ports, NVMe* drives are not supported on 1U/2U systems.</p>


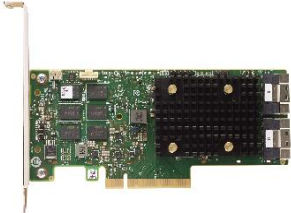

Image	Details	Description
	<p>Intel® Storage Adapter RS3P4GF016J</p> <p>iPC RS3P4GF016J MM# 999TJ3 UPC 00735858452823 EAN 5032037193108 MOQ 5</p> <p>Product type 1U/2U accessory kit</p>	<p>Low Profile, half length, (MD2 Compliant) PCIe* add-in card Entry level Tri-Mode SAS / SATA adapter 16 external SAS / SATA ports Broadcom* SAS3816 IOC JBOD (SAS / SATA connectivity)</p> <p>SAS data cables are not included and must be purchased separately.</p> <p>Note: This card is PCIe* 4.0, however, it runs at the highest PCIe* standard supported by the server board (PCIe* 3.0). Note: This card was validated only for SAS / SATA ports, NVMe* drives are not supported on 1U/2U systems.</p>
	<p>Intel® RAID Adapter RS3P4TF160F</p> <p>iPC RS3P4TF160F MM# 999TJ4 UPC 00735858452816 EAN 5032037193092 MOQ 5</p> <p>Product type 1U/2U accessory kit</p>	<p>Low Profile, half length, (MD2 Compliant) PCIe* add-in card Full Featured Tri-Mode RAID Controller 16 internal SAS / SATA ports Broadcom* SAS3916 ROC RAID Levels – 0/1/10/5/6/50/60 and JBOD Supports Maintenance Free Backup Unit – iPC AXXRMFBU7</p> <p>SAS data cables are not included and must be purchased separately.</p> <p>Note: This card is PCIe* 4.0, however, it runs at the highest PCIe* standard supported by the server board (PCIe* 3.0). Note: This card was validated only for SAS / SATA ports, NVMe* drives are not supported on 1U/2U systems.</p>
	<p>Intel® RAID Adapter RS3P4MF088F</p> <p>iPC RS3P4MF088F MM# 99ADDX UPC 00735858486590 EAN 5032037223287 MOQ 5</p> <p>Product type 1U/2U accessory kit</p>	<p>Low Profile, half length, (MD2 Compliant) PCIe* add-in card Full Featured Tri-Mode RAID Controller 8 internal SAS / SATA ports 8 external SAS Broadcom* SAS3916 ROC RAID Levels – 0/1/10/5/6/50/60 and JBOD Supports Maintenance Free Backup Unit – iPC AXXRMFBU7</p> <p>SAS data cables are not included and must be purchased separately.</p> <p>Note: This card is PCIe* 4.0, however, it runs at the highest PCIe* standard supported by the server board (PCIe* 3.0). Note: This card was validated only for SAS / SATA ports, NVMe* drives are not supported on 1U/2U systems.</p>

Table 74. Intel® RAID accessory options





Image	Details	Description
	<p>Intel® RAID SSD Cache with Fast Path I/O</p> <p>iPC AXXPFKSSD2 MM# 919499 UPC 00735858221467 EAN 5032037051699 MOQ 5</p> <p>Product type 1U/2U accessory kit</p>	<p>Upgrade key to enable SSD cache with fast path I/O for Intel® RAID Controller RS25 and RS3 (based on LSI* 3108) families of ROC products.</p>
	<p>Intel® RAID Drive Encryption Management</p> <p>iPC AXXPFKDE2 MM# 915317 UPC 00735858221474 EAN 5032037051705 MOQ 5</p> <p>Product type 1U/2U accessory kit</p>	<p>Upgrade key to enable drive encryption management for Intel® RAID Controller RS25 and RS3 (based on LSI* 3108) families of ROC products.</p>
	<p>Intel® RAID Rapid Recovery Snapshot</p> <p>iPC AXXPFKSNSH2 MM# 915318 UPC 00735858221481 EAN 5032037051712 MOQ 5</p> <p>Product type 1U/2U accessory kit</p>	<p>Upgrade key to enable rapid recovery snapshot for Intel® RAID Controller RS25 and RS3 (based on LSI* 3108) families of ROC products.</p>
	<p>Intel® RAID High Availability Activation Key</p> <p>iPC AXXPFKHA2 MM# 927236 UPC 00735858257909 EAN 5032037049672 MOQ 1</p> <p>Product type 1U/2U accessory kit</p>	<p>Activation key to enable the Intel® RAID Controller RS3SC008 to provide failover for two servers in a cluster or shared storage environment.</p>





Image	Details	Description
	<p>Intel® Embedded Server RAID Technology 2 SATA Software RAID Activation Key</p> <p>iPC RKSATA4R5 MM# 916346 UPC 00735858238861 EAN 5032037033640 MOQ 5</p> <p>Product type 1U/2U accessory kit</p>	<p>Used to enable onboard SATA controllers to support Intel® Embedded Server RAID Technology 2 software RAID 5</p>
	<p>Intel® Virtual RAID on CPU (Intel® VROC) – Intel® SSD Only Key</p> <p>iPC VROCISSDMOD MM# 956822 UPC 00735858337274 EAN 5032037100021 MOQ 5</p> <p>Product type 1U/2U accessory kit</p>	<p>Activation key to support RAID (0, 1, 5, 10) functionality only on NVMe* SSDs from Intel</p>
	<p>Intel® Virtual RAID on CPU (Intel® VROC) – Standard Model Key</p> <p>iPC VROCSTANMOD MM# 951605 UPC 00735858337243 EAN 5032037100007 MOQ 5</p> <p>Product type 1U/2U accessory kit</p>	<p>Activation key to support non-Intel® SSDs for NVMe* and enable RAID (0, 1, 10) functionality</p>
	<p>Intel® Virtual RAID on CPU (Intel® VROC) – Premium Model Key</p> <p>iPC VROCPREMMOD MM# 951606 UPC 00735858337267 EAN 5032037100014 MOQ 5</p> <p>Product type 1U/2U accessory kit</p>	<p>Activation key to support non-Intel® SSDs for NVMe* and enable Intel® VROC Premium, RAID (0, 1, 5, 10) with RAID write hole closure</p>






Image	Details	Description
	<p>Intel® RAID Maintenance Free Backup Unit AXXRMFBU7</p> <p>iPC AXXRMFBU7 MM# 957677 UPC 00735858336192 EAN 5032037099790 MOQ 5</p> <p>Product type 1U/2U accessory kit</p>	<p>A super-capacitor module designed to protect data in dynamic memory during a power failure or system crash event. The AXXRMFBU7 is used with the full-featured tri-mode RAID modules and controllers.</p> <p>Compatible with:</p> <ul style="list-style-type: none"> • Intel® Integrated RAID Module RMSP3AD160F • Intel® Integrated RAID Module RMSP3CD080F • Intel® RAID Controller RSP3TD160F • Intel® RAID Controller RSP3DD080F • Intel® RAID Controller RSP3MD088F
	<p>Intel® RAID Maintenance Free Backup Unit AXXRMFBU6</p> <p>iPC AXXRMFBU6 MM# 945975 UPC 00735858306768 EAN 5032037080163 MOQ 5</p> <p>Product type 1U/2U accessory kit</p>	<p>A super-capacitor module designed to protect data in dynamic memory during a power failure or system crash event. The AXXRMFBU6 is used with the full-featured RAID controllers.</p> <p>Compatible with:</p> <ul style="list-style-type: none"> • Intel® Integrated RAID Module RMS3AC160
	<p>Intel® RAID Maintenance Free Backup Unit AXXRMFBU5</p> <p>iPC AXXRMFBU5 MM# 933907 UPC 00735858276801 EAN 5032037060417 MOQ 5</p> <p>Product type 1U/2U accessory kit</p>	<p>A super-capacitor module and flash memory card designed to help protect data in dynamic memory during a power failure or system crash event. The AXXRMFBU5 kit is used with the 12 Gb/s Intel® Integrated RAID Modules.</p> <p>Compatible with:</p> <ul style="list-style-type: none"> • Intel® Integrated RAID Module RMS3CC080 • Intel® Integrated RAID Module RMS3CC040
	<p>Intel® RAID Maintenance Free Backup Unit AXXRMFBU4</p> <p>iPC AXXRMFBU4 MM# 937318 UPC 00735858273787 EAN 5032037058544 MOQ 5</p> <p>Product type 1U/2U accessory kit</p>	<p>A super-capacitor module and flash memory card designed to help protect data in dynamic memory during a power failure or system crash event. The AXXRMFBU4 kit is used with the 12 Gb/s Intel® RAID Controller PCIe* Add-in Cards.</p> <p>Compatible with:</p> <ul style="list-style-type: none"> • Intel® RAID Controller RS3DC080 • Intel® RAID Controller RS3DC040 • Intel® RAID Controller RS3SC008 • Intel® RAID Controller RS3MC044

Image	Details	Description
	<p>1U/2U RMFBU Mounting Option Kit</p> <p>iPC AWTAXBBUBKT MM# 937082 UPC 00735858289344 EAN 5032037068321 MOQ 1</p> <p>Product type 1U/2U accessory kit</p>	<p>Kit includes:</p> <p>(1) – 2U RMFBU mounting plate. The mounting plate installs in one of two possible mounting locations on the 2U air duct and can support up to two AXXRMFBU5 or AXXRSBBU9 units. Full length PCIe* cards cannot be supported when this mounting plate is installed behind the given riser slot.</p> <p>(1) – RMFBU plastic housing bracket to support two stacked AXXRMFBU5 units in a 1U chassis.</p>

5.6 Power Supply Modules and Power Cords

Table 75. Power supply modules and power cords




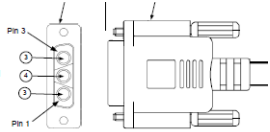

Image	Details	Description
	<p>1100W AC Common Redundant Power Supply</p> <p>iPC AXX1100PCRPS MM# 936183 UPC 00735858287920 EAN 5032037067478 MOQ 1</p> <p>Product type 1U/2U building block/spare FRU 1U/2U accessory kit</p>	<p>1100 W AC common redundant power supply with 80 PLUS* Platinum efficiency. Power cord sold separately.</p>
	<p>1300W AC Common Redundant Power Supply</p> <p>iPC AXX1300TCRPS MM# 956542 UPC 00735858345705 EAN 5032037106191 MOQ 1</p> <p>Product type 1U/2U building block/spare FRU 1U/2U accessory kit</p>	<p>1300 W AC common redundant power supply with 80 PLUS* Titanium efficiency. Power cord sold separately.</p>
	<p>This part is no longer available, see PCN 117538-00 for more details.</p> <p>750W DC Common Redundant Power Supply</p> <p>iPC AXX750DCCRPS MM# 927253 UPC 00735858260862 EAN 5032037051354 MOQ 1</p> <p>Product type 1U/2U building block/spare FRU 1U/2U accessory kit</p>	<p>750 W -48v DC common redundant power supply with 80 PLUS* Gold efficiency.</p> <p>Kit includes: (1) – power supply (1) – O-ring terminal adapter</p> <p>Power cable sold separately.</p>

Image	Details	Description
	<p>4000 mm (13 ft) DC power cable</p> <p>iPC AXXDCCRPSCBL MM# 922062 UPC 00735858247993 EAN 5032037042871 MOQ 1</p> <p>Product type 1U/2U spare FRU 1U/2U accessory kit</p>	<p>Optional power cord for DC input power supplies. Connects directly to power supply instead of O-ring terminals adapter.</p>
	<p>1500 mm (59 in) North America power cable</p> <p>iPC FPWRCABLENA MM# 879287 UPC 00735858181129 EAN 5032037015738 MOQ 1</p> <p>Product type 1U/2U spare FRU 1U/2U accessory kit</p>	<p>1500 mm (59 in) North America power cable</p>

5.7 1U/2U Rack Mount Kits

Caution: Exceeding the rail kit's specified maximum weight limit or misalignment of the server in the rack may result in failure of the rack rails, resulting in damage to the system or personal injury. Using two people or the use of a mechanical assist tool to install and align the server into the rack is highly recommended.

Table 76. Rack mount kits




Image	Details	Description
	<p>1U/2U Enhanced Value Rail Kit</p> <p>iPC AXCELVRAIL MM# 920970 UPC 00735858244367 EAN 5032037038980 MOQ 1</p> <p>Product type 1U/2U accessory kit</p>	<ul style="list-style-type: none"> • Works for all 438 mm wide Intel® Chassis 1U, 2U, 4U • Adjustment within 609.6 mm ~ 765 mm to fit difference depth rack • 424.2 mm maximum travel length • 2/3 extension from rack • 130 lbs. (59 kg) max support weight • Tool-less chassis attach • Tools required to attach to rails to rack <p>Note: No cable management arm support.</p>
	<p>1U Premium quality rails with no CMA support</p> <p>iPC A1USHRTRAIL MM# 939208 UPC 00735858289931 EAN 5032037068772 MOQ 1</p> <p>Product type 1U accessory kit</p>	<ul style="list-style-type: none"> • Travel distance 780 mm • Adjustment within 609.6 mm ~ 762 mm to fit difference depth rack. • Tool-less installation • Full extension from rack <p>Kit includes: Rails, screws, installation manual</p>
	<p>1U Premium quality rails with CMA support</p> <p>iPC A1UFULLRAIL MM# 939207 UPC 00735858291972 EAN 5032037070539 MOQ 1</p> <p>Product type 1U accessory kit</p>	<ul style="list-style-type: none"> • Travel distance 780 mm • Adjustment within 609.6 mm ~ 762 mm to fit difference depth rack. • Tool-less installation • Full extension from rack <p>Kit includes: Rails, screws, installation manual Compatible with Cable Management Arm AXX1U2UCMA</p>




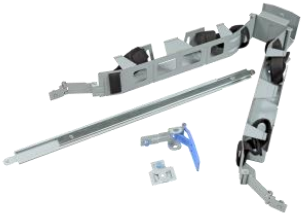
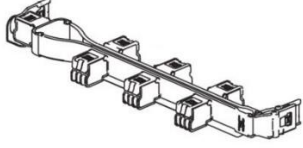
Image	Details	Description
	<p>2U+ Premium quality rails with CMA support</p> <p>iPC AXXFULLRAIL MM# 939209 UPC 00735858291989 EAN 5032037070546 MOQ 1</p> <p>Product type 2U accessory kit</p>	<ul style="list-style-type: none"> • Travel distance 800 mm • Adjustment within 594.8 mm~813 mm to fit difference depth rack. • Tool-less installation • Full extension from rack <p>Kit includes: Rails, screws, installation manual Compatible with Cable Management Arm AXXCMA2</p>
	<p>2U+ Premium quality rails with no CMA support</p> <p>iPC AXXSHRTRAIL MM# 939210 UPC 00735858291996 EAN 5032037070553 MOQ 1</p> <p>Product type 2U accessory kit</p>	<ul style="list-style-type: none"> • Travel distance 788 mm • Adjustment within 594.8 mm ~ 813 mm to fit difference depth rack. • Bracket adjustment from 594.8mm to 813mm • Tool-less installation • Supports up to 45Kg • Full extension from rack <p>Kit includes: Rails, screws, installation manual</p>
	<p>1U/2U 2-Post fixed mount bracket kit</p> <p>iPC AXX2POSTBRCKT MM# 918808 UPC 00735858245319 EAN 5032037039833 MOQ 1</p> <p>Product type 1U/2U accessory kit</p>	<ul style="list-style-type: none"> • 1U and 2U compatible • Tools required to attach components to rack
	<p>1U/2U Cable Management Arm (CMA)</p> <p>iPC AXX1U2UCMA MM# 913117 UPC 00735858224604 EAN 5032037019972 MOQ 1</p> <p>Product type 1U accessory kit</p>	<p>Compatible with Premium 1U A1UFULLRAIL rail kit option only</p>

Image	Details	Description
	<p>Cable Management Arm (CMA)</p> <p>iPC AXXCMA2 MM# 939211 UPC 00735858292009 EAN 5032037070560 MOQ 1</p> <p>Product type 2U accessory kit</p>	<p>Compatible with Premium 2U+ AXXFULLRAIL only</p>

6. 1U/2U Miscellaneous Accessory Options

Table 77. Miscellaneous accessory options




Image	Details	Description
	<p>Slimline SATA DVDROM Drive</p> <p>iPC AXXSATADVDROM MM# 937569 UPC 00735858197663 EAN 5032037015127 MOQ 1</p> <p>Product type 1U/2U accessory kit</p>	<p>Includes 880 mm SATA cable AXXCBL880SATA Peripheral power cable and mounting kit are included with systems that have support for an optical drive. Optical drives are not supported in R2312WF and R2224WF based systems</p>
	<p>Slimline SATA DVD+/- ROM Drive</p> <p>iPC AXXSATADVDRWROM MM# 937575 UPC 00735858197670 EAN 5032037015134 MOQ 1</p> <p>Product type 1U/2U accessory kit</p>	<p>Includes 880 mm SATA cable AXXCBL880SATA Peripheral power cable and mounting kit are included with systems that have support for an optical drive. Optical drives are not supported in R2312WF and R2224WF based systems</p>
	<p>1U/2U Rack Handle Kit</p> <p>iPC A2UHANDLKIT MM# 936038 UPC 00735858288866 EAN 5032037068147 MOQ 1</p> <p>Product type 2U drive upgrade kit 1U/2U spares kit</p>	<p>This kit includes (3) different rack handles, including:</p> <ul style="list-style-type: none"> • (1) – Set of 2U storage rack handles with control panel and USB support (R2312WFxxxx & R2224WFxxxx) • (1) – Set of 2U non –storage rack handles (R2208WFxxxx & R2208WFxxxx + 8 Drive Accessory Kit) • (1) – Set of 1U rack handles (R1304WFxxxx & R1208WFxxxx) <p>This kit includes replacement chassis handles for all product family 1U and 2U systems. In addition, this kit must be purchased for 2U building block configurations consisting of 24x2.5" drives (3 drive bay modules) or when upgrading a R2208WF or R2208WF + 8 Drive Accessory Kit system to a 24 drive R2224WF system, where the standard chassis rack handles must be replaced with a pair of storage rack handles that include the system front panel and front USB 2.0 port.</p> <p>See the appropriate <i>Intel® Server System Product Family System Integration and Service Guide</i> for complete system integration, upgrade, and part replacement instructions.</p> <p>Note: The 2U storage rack handles are not supported on R2312WFTF systems.</p>





Image	Details	Description
	<p>Serial Port Cable Kit</p> <p>iPC AXXRJ45DB93 MM# 920430 UPC 00735858242820 EAN 5032037037525 MOQ 1</p> <p>Product type 1U/2U accessory kit</p>	<p>This kit provides serial port cables for use with systems that include a back panel cut out to support a DB9 Serial 'B' port as routed from the server board and for systems that include an external RJ45 Serial 'A' port that need to convert the connector to a DB9 style connector.</p> <p>Kit includes: (1) – 1040 mm Internal Serial 'B' port cable – Onboard DH10 header- to- External Mount DB9 – for 2U systems (1) – 520 mm Internal Serial 'B' port cable – Onboard DH10 header- to- External mount DB9 – for 2U systems (1) – 100 mm DCD RJ45 to DB9 Dongle (1) – 100 mm DSR RJ45 to DB9 Dongle</p>
	<p>Intel® Remote Management Module 4 Lite Activation Key</p> <p>iPC AXXRMM4LITE2 MM# 946514 UPC 00735858307413 EAN 5032037080750 MOQ 1</p> <p>Product type 1U/2U accessory kit</p>	<p>Installation of this activation key on to the server board enables support for the following advanced server management features:</p> <ul style="list-style-type: none"> • Integrated KVM • Media Redirection <p>See the <i>Intel® Remote Management Module 4 and Integrated Web Console Users Guide</i> for more information.</p>
	<p>Trusted Platform Module (TPM) 2.0</p> <p>iPC AXXTPMENC8 MM# 955867 UPC 00735858345712 EAN 5032037106207 MOQ 1</p> <p>Product type 1U/2U accessory kit</p>	<p>A TPM is a hardware-based security device that addresses the growing concern on boot process integrity and offers better data protection. TPM protects the system start-up process by ensuring it is tamper-free before releasing system control to the operating system. A TPM device provides secured storage to store data, such as security keys and passwords. In addition, a TPM device has encryption and hash functions.</p> <p>AXXTPMENC8 implements TPM as per TPM PC Client specifications revision 2.0 by the Trusted Computing Group (TCG)</p> <p>Note: Products having an S2600WFTF baseboard have the TPM installed down rather than using this module.</p>
	<p>Intel® Trusted Platform Module (TPM) 2.0</p> <p>iPC AXXTPMCHNE8 MM# 960608 UPC 00735858347341 EAN 5032037107068 MOQ 1</p> <p>Product type 1U/2U accessory kit</p>	<p>Note: AXXTPMCHNE8 compatible for use in China.</p> <p>A TPM is a hardware-based security device that addresses the growing concern on boot process integrity and offers better data protection. TPM protects the system start-up process by ensuring it is tamper-free before releasing system control to the operating system. A TPM device provides secured storage to store data, such as security keys and passwords. In addition, a TPM device has encryption and hash functions.</p> <p>AXXTPMCHNE8 implements TPM as per TPM PC Client specifications revision 2.0 by the Trusted Computing Group (TCG)</p>

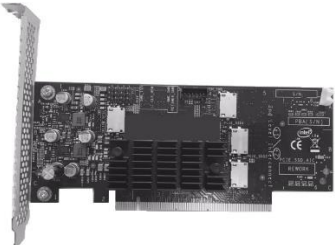


Image	Details	Description
	<p>4-Port PCIe* (x16 to x16) SSD Retimer Add-in Card 4P (OCuLink)</p> <p>iPC AXXP3RTX16040 MM# 958240 UPC 00735858345613 EAN 5032037106108 MOQ 1</p> <p>Product type 1U/2U accessory kit</p>	<p>Note: For Riser #2 only.</p> <p>The SSD retimer add-in card connects up to four x4 PCIe* Gen3 links from any standard x16 PCIe* slot on the baseboard to a PCIe* SSD capable HSBP via four bundled OCuLink cables. The retimer is a low profile form factor standard x16 PCIe* card.</p> <p>Kit includes: (1) – 4-Port PCIe* SSD Retimer AIC – iPN H88402-xxx (1) – 350 mm PEM Cable – iPN J14812-xxx (1) – Low profile bracket – iPN J32838-xxx</p> <p>Additional required accessory: Connection to a PCIe* capable HSBP requires the addition of one of the following cable kits for each retimer:</p> <ul style="list-style-type: none"> • R1208 – iPC A1U4PRTCXCXK • R2208, R2208+8 and R2224 – iPC A2U4PRTCXCXK <p>Note: PCIe* retimer card installed to Riser #1 is not supported. PCIe* retimer card is not compatible with R2312WFxxx systems.</p>
	<p>4 Port PCIe* x8 Switch Add-in Card</p> <p>iPC AXXP3SWX08040 MM# 958241 UPC 00735858345620 EAN 5032037106115 MOQ 1</p> <p>Product type 1U/2U accessory kit</p>	<p>This switch add-in card is used to increase the number of PCIe* SSD drives within the system by 4. The 4-drive switch is a low profile MD2 form factor PCIe* card.</p> <p>Additional required accessory: The following cable kit is required to connect the 4-port switch to the HSBP in R1208 system:</p> <ul style="list-style-type: none"> • iPC A1U4PSWCXCXK <p>One of the following cable kits is required to connect the 4 port switch to the HSBP in R2208, R2208+8 and R2224 systems:</p> <ul style="list-style-type: none"> • iPC A2U4PSWCXCXK1 • iPC A2U4PSWCXCXK2
	<p>8 Port PCIe* x8 Switch Add-in Card</p> <p>iPC AXXP3SWX08080 MM# 958242 UPC 00735858345637 EAN 5032037106122 MOQ 1</p> <p>Product type 2U accessory kit</p>	<p>This switch add-in card is used to increase the number of PCIe* SSD drives within the system by 8. The 8-drive switch is a full height form factor PCIe* card.</p> <p>Additional required accessory: One of the following cable kits is required to connect the 8 port switch to the HSBP in R2208, R2208+8 and R2224 systems:</p> <ul style="list-style-type: none"> • iPC A2U8PSWCXCXK1 • iPC A2U8PSWCXCXK2 • iPC A2U8PSWCXCXK3



Image	Details	Description
	<p>Processor Clip</p> <p>iPC FXXCPUCLIP MM# 958248 UPC 00735858344425 EAN 5032037105217 MOQ 2</p> <p>Product type 1U/2U accessory kit 1U/2U spare kit</p>	<p>Spare standard processor clip</p> <p>Kit Includes: (1) standard processor clip</p>
	<p>Fabric Processor Clip</p> <p>iPC FXXCPUCLIPF MM# 958275 UPC 00735858344432 EAN 5032037105224 MOQ 2</p> <p>Product type 1U/2U accessory kit 1U/2U spare kit</p>	<p>This accessory kit provides the clip necessary to attach a fabric supported Intel® Xeon® Scalable processor to the CPU heat sink.</p> <p>This kit must be ordered to support dual fabric CPU configurations when installing either of the following IFT Carrier Accessory Kits:</p> <ul style="list-style-type: none"> • iPC AWF1PFABKITM • iPC AWF1PFABKITP <p>Kit includes: (1) fabric processor clip</p>

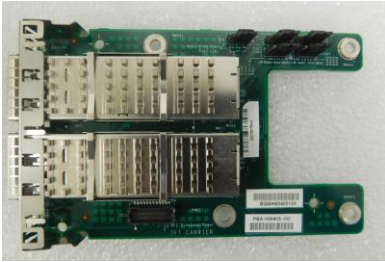
Image	Details	Description
	<p>Mezzanine Fabric Carrier Kit</p> <p>iPC AWF1PFABKITM MM# 955873 UPC 00735858345644 EAN 5032037106139 MOQ 1</p> <p>Product type 1U/2U accessory kit</p>	<p>This board allows external access to the Intel® Omni-Path Host Fabric Interface (Intel® OP HFI) of fabric supported processors. The connection to the external access is done through two QSFP+28 style connections.</p> <p>The mezzanine fabric carrier board is designed to be mounted within the OCP* module bay of either the 1U or 2U chassis. All required signals/power for the board are passed through the included sideband cable.</p> <p>Kit includes:</p> <ul style="list-style-type: none"> (1) – IFT Carrier Mezzanine Board – iPN H88405-xxx (1) – 235 mm cable (iPN H79272-xxx), 1 port, Mezzanine card to Fabric Processor #1 (1) – 430 mm cable (iPN H77497-xxx), 2x12 HFI Sideband Y Cable, Single Intel® Omni-Path Sideband IFT Carrier to dual Intel® Omni-Path CPU connectors (Mezzanine card to server board CPU HFI Sideband connectors) (1) – Fabric Processor Clip (iPN J61895-xxx) <p>Note: The 4 screws used to mount the IFT Mezzanine card to the OCP Mezz stand-offs are preinstalled in the chassis/system.</p> <p>Additional required accessory for dual fabric processor support:</p> <p>Dual Fabric processor configurations require the following additional accessory kits to be ordered separately:</p> <ul style="list-style-type: none"> • Cable kit AXXCBL370IFPS1 (Mezzanine card to Fabric Processor #2) • Fabric Processor Clip Kit FXXCPUCLIPF – Used to attach fabric enabled processor to processor heat sink <p>Important: This product is only compatible with external Intel® Omni-Path passive cables (copper) and active cables (optical) up to class 3. For a list of recommended cables, contact your Intel representative.</p>




Image	Details	Description
	<p>PCIe* Add-in Fabric Carrier Kit</p> <p>iPC AWF1PFABKITP MM# 955859 UPC 00735858345651 EAN 5032037106146 MOQ 1</p> <p>Product type 1U/2U accessory kit</p>	<p>This kit allows external access to the Intel® Omni-Path Host Fabric Interface (Intel® OP HFI) of fabric supported processors. The connection to the external access is done through two QSFP+28 style connections.</p> <p>The IFT Carrier add-in card can only be supported when installed to a PCIe* add-in card slot on Riser 2. No PCIe* related signals are passed through; the slot is only being used for mechanical mounting along with drawing power and SMBus signals.</p> <p>Kit includes:</p> <ul style="list-style-type: none"> (1) – IFT Carrier PCIe* Add-in Board (1) – 235 mm cable (iPN H79267-xxx), 1 port, PCIe* add-in card to Fabric Processor #1 (1) – 430 mm 2x12 HFI Sideband Y Cable, Single Intel® Omni-Path Sideband IFT Carrier to dual Intel® Omni-Path CPU connectors (PCIe* add-in card to server board CPU HFI Sideband connectors) (1) – Fabric Processor Clip <p>Additional required accessory for dual fabric processor support: Dual Fabric processor configurations require the following additional accessory kits to be ordered separately:</p> <ul style="list-style-type: none"> • Cable kit AXXCBL235IFPR1 – 235mm cable (iPN H79272-xxx), PCIe* Add-in card to Fabric Processor #2 • Fabric Processor Clip Kit FXXCPUCLIPF – Used to attach fabric enabled processor to processor heat sink <p>Important: This product is only compatible with external Intel® Omni-Path passive cables (copper) and active cables (optical) up to class 3. For a list of recommended cables, contact your Intel representative.</p>
	<p>High Airflow Air Duct Kit</p> <p>iPC AWFCOPRODUCTAD MM# 961767 UPC 00735858351270 EAN 5032037109666 MOQ 1</p> <p>Product type 2U accessory kit</p>	<p>Required 2U accessory kit when installing an Intel® Xeon Phi™ coprocessor card with passive heat sink (heat sink only, no fan) or non-Intel GPGPU with passive heat sink.</p> <p>Kit includes:</p> <ul style="list-style-type: none"> (1) – High airflow air duct <p>Note: Intel® Xeon Phi™ cards with active heat sinks are not supported in systems configured with the high airflow air duct.</p> <p>Additional required accessory:</p> <ul style="list-style-type: none"> • High Airflow Air Duct Bracket Kit, which includes the metal shipping bracket and non-Intel GPGPU secure mounting adapters – iPC AWFCOPRODUCTBKT • 2-slot PCIe* Riser card option, which includes a 2-slot riser PCBA and a 12V AUX power cable – iPC A2UL16RISER2

Image	Details	Description
	<p>High Airflow Air Duct Bracket Kit</p> <p>iPC AWFCOPRODUCTBKT MM# 961675 UPC 00735858351720 EAN 5032037109949 MOQ 1</p> <p>Product type 2U accessory kit</p>	<p>Required 2U accessory kit when installing an Intel® Xeon Phi™ coprocessor card with passive heat sink (heat sink only, no fan) or non-Intel GPGPU with passive heat sink.</p> <p>Kit includes: (1) – Metal shipping bracket (2) – Non-Intel GPGPU secure mounting adapters</p> <p>Note: Intel® Xeon Phi™ cards with active heat sinks are NOT supported in systems configured with the high airflow air duct.</p> <p>Note: Systems configured with any type of Intel® Xeon Phi™ card and/or non-Intel GPGPU card must have the shipping bracket installed before the system is exposed to any level of shock or vibration or is shipped to the end user location. Failure to install the shipping bracket has the potential to cause serious damage to various components within the system.</p> <p>Additional required accessory: High Airflow Duct Kit which includes a high flow air duct – iPC AWFCOPRODUCTAD 2-slot PCIe* Riser card option which includes a 2-slot riser PCBA and a 12V AUX power cable – iPC A2UL16RISER2</p>

7. 1U/2U Spare and Replacement Parts (FRUs)

System integrators and distributors may choose to hold additional stock of individual system components. Intel makes available the following spare and replacement parts (FRUs) compatible with the specified Intel® server family.

Table 78. Spare and replacement parts





Image	Details	Description
	<p>Front Panel Board</p> <p>iPC FXXFPANEL2 MM# 937543 UPC 00735858288712 EAN 5032037067997 MOQ 1</p> <p>Product type 1U/2U spare FRU</p>	<p>Front Panel board spare for all R1000WF and R2000WF systems, except R2224 and R2312.</p> <p>Includes one front panel board.</p>
	<p>1U Spare Fan Assembly (3 Fans)</p> <p>iPC FR1UFAN10PW MM# 974906 UPC 00735858283342 EAN 5032037064408 MOQ 1</p> <p>Product type 1U spare FRU</p>	<p>Three spare fans for R1000WF systems as an assembly. 40x56 mm dual rotor with 10p connector.</p> <p>Includes three fans in the bracket with grommets preinstalled.</p>
	<p>2U Spare Fan (2 Fans/Kit)</p> <p>iPC FR2UFAN60HSW MM# 934990 UPC 00735858283359 EAN 5032037064415 MOQ 1</p> <p>Product type 2U spare FRU</p>	<p>Two spare fans for R2000WF systems. 60x38mm, with hot swap connector.</p> <p>Includes two fans with finger guards and housing.</p>
	<p>4x3.5" Spare Hot Swap Backplane</p> <p>iPC FR1304S3HSBP MM# 934887 UPC 00735858288835 EAN 5032037068116 MOQ 1</p> <p>Product type 1U spare FRU</p>	<p>Hot swap backplane board spare for R1304 systems.</p> <p>Includes one backplane board.</p>

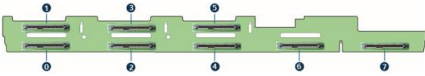







Image	Details	Description
	<p>8x2.5" SAS/NVMe* Hot Swap Backplane</p> <p>iPC F1U8X25S3PHS MM# 955868 UPC 00735858344890 EAN 5032037105606 MOQ 1</p> <p>Product type 1U spare FRU</p>	<p>Combination hot swap backplane board spare supporting SAS and NVMe* drives in the R1208 system.</p> <p>Includes one backplane board.</p>
	<p>8x3.5" Hot Swap Backplane</p> <p>iPC F2U8X35S3HSBP MM# 934892 UPC 00735858288811 EAN 5032037068093 MOQ 1</p> <p>Product type 2U spare FRU</p>	<p>Hot swap backplane board spare for R2308 systems.</p> <p>Includes one backplane board.</p>
	<p>8x2.5" SAS/NVMe* Hot Swap Backplane</p> <p>iPC F2U8X25S3PHS MM# 955870 UPC 00735858344913 EAN 5032037105620 MOQ 1</p> <p>Product type 2U spare FRU</p>	<p>Combination hot swap backplane board spare supporting SAS and NVMe* drives in the R2208 systems.</p> <p>Includes one backplane board.</p>
	<p>12x3.5" SAS and 2x NVMe* Hot Swap Backplane</p> <p>iPC F2U12X35S3PH MM# 955869 UPC 00735858344906 EAN 5032037105613 MOQ 1</p> <p>Product type 2U spare FRU</p>	<p>Hot-swap backplane board spare supporting 12GB SAS drives plus 2 NVMe* drives.</p> <p>Includes one backplane board.</p>

Image	Details	Description
	<p>2.5" Tool Less Hot Swap Drive Carrier</p> <p>iPC FXX25HSCAR3 MM# 958244 UPC 00735858345668 EAN 5032037106153 MOQ 1</p> <p>Product type 1U/2U spare FRU</p>	<p>Spare 2.5" tool less drive hot swap carrier</p>
	<p>3.5" Tool Less Hot Swap Drive Carrier</p> <p>iPC FXX35HSCAR2 MM# 958245 UPC 00735858345675 EAN 5032037106160 MOQ 1</p> <p>Product type 1U/2U spare FRU</p>	<p>Spare 3.5" tool less drive hot swap drive carrier Includes mounting screws for mounting 2.5" SSDs.</p>
	<p>ODD Data Cable</p> <p>iPC AXXCBL880SATA MM# 922988 UPC 00735858250290 EAN 50320370448060 MOQ 10</p> <p>Product type 1U/2U spare FRU</p>	<p>Spare optical disk drive data cable for rack chassis family, 880 mm long. Included with optical drives AXXSATADVDRAM and AXXSATADVDRWROM.</p>

8. Intel® Visual Compute Accelerators

The Intel® Visual Compute Accelerator 2 (Intel® VCA 2) brings high definition (HD) and ultra-high definition (UHD) media processing capabilities to Intel® Xeon® processor Scalable family platforms. The Intel® VCA 2 card integrates three Intel® Xeon® E3 processors with Intel® Iris® Pro Graphics P580 enabled hardware accelerated video processing into a PCIe* card form factor that fits into servers based on Intel® Xeon® processor Scalable family.

- Equips Intel® Server Systems with powerful rendering performance of P580 Iris Pro Graphics and ultra-fast media transcode performance of Intel® Quick Sync Video.
- Full complement of bare metal operating systems for the onboard Intel® Xeon® processor E3-1500 v5 nodes for application software support across multiple market segments: CentOS 7.x, Windows* 10, Windows* Server 2016.
- PCIe* x8 to each of the three onboard Intel® Xeon® processor E3-1500L v5 nodes highly supports bandwidth intensive media ingest.
- Multiple 1U and 2U server system options and a strong ISV ecosystem for ease of solution deployment.

Image	Details	Description
	<p>Intel® Visual Compute Accelerator 2</p> <p>iPC VCA1585LMV MM# 954907 UPC 00735858334532 EAN 5032037099127 MOQ 1</p> <p>Product type 1U/2U accessory kit</p>	<ul style="list-style-type: none"> • Full-length, full-height, double-width Gen3 PCIe* x16, 8 lanes per processor • 4 cores supported • 45W TDP • Processor number E3-1585LV5 • Base freq. 3.0 GHz, Max turbo freq 3.7 GHz • Max memory size 192 GB (DDR4 2133/2400 at 1.2V)

Appendix A. Glossary

Term	Definition
AIC	Add-in card
BIK	Baseboard In Knock-Down-Kit – Integrated System
CMA	Cable Management Arm
CRPS	Common Redundant Power Supply
DDDC	Double Device Data Correction
EAN	International Article Number (Barcode)
ECC	Error Correcting Code
EMI	Electromagnetic Interference
FRU	Field Replaceable Unit
GPGPU	General Purpose computing on Graphics Processing Unit
iPC	Intel Product Code
iPN	Intel Product Number
JBOD	Just a bunch of drives
L6 BIK	Integrated system with no processors, memory, or storage devices installed
L9 BIK	Integrated system including storage devices, but no processors or memory
KDK	Knock-Down-Kit – (Chassis only product)
KVM	Keyboard, Video, Mouse
MM#	Master Material order number
MOQ	Minimum Order Quantity
NVMe*	NVM Express* – based on Non-Volatile Memory Host Controller Interface Specification (NVMHCI)
ODD	Optical disk drive
Intel® OP HFI	Intel® Omni-Path Host Fabric Interface
Optional Accessory	Hardware that can be added to the system to enhance the default feature set of the shipping configuration
PCBA	Printed Circuit Board Assembly
Intel® QAT	Intel® QuickAssist Technology
QSFP	Quad Small Form factor Pluggable
RAID	Redundant Array of Independent Drives
Required Option	Hardware that must be added to the shipping configuration for the system to operate
RMFBU	RAID Maintenance Free Backup Unit
Intel® RMM4 Lite	Intel® Remote Management Module 4 Lite Activation key
ROC	RAID on Chip
Intel® RSTe	Intel® Rapid Storage Technology enterprise

Term	Definition
SAS	Serial Attached SCSI
SATA	Serial ATA
SFF NVMe*	NVMe* SSD in a 2.5" form factor
SFP	Small Form factor Pluggable
SKU	Stock Keeping Unit
SSD	Solid State Drive
TPM	Trusted Platform Manager
UPC	Universal Product Code (Barcode)
Intel® VCA	Intel® Visual Compute Accelerator
Intel® VROC	Intel® Virtual RAID on CPU
PCN	Product Change Notification

Mouser Electronics

Authorized Distributor

Click to View Pricing, Inventory, Delivery & Lifecycle Information:

[Intel:](#)

[AXX1300TCRPS](#) [AXXP3SWX08080](#)