

Product Brief

Introduction

The AVR® DB Family of microcontrollers is using the AVR® CPU with hardware multiplier running at clock speeds up to 24 MHz, with up to 128 KB of Flash, 16 KB of SRAM, and 512 bytes of EEPROM in 28-, 32-, 48- or 64-pin packages. The AVR® DB Family uses the latest technologies from Microchip with a flexible and low-power architecture, including Event System, accurate analog subsystems, and advanced digital peripherals.

AVR® DB Family Overview

The figure below shows the AVR® DB Family of devices, laying out pin count variants and memory sizes:

- Vertical migration is possible without code modification, as these devices are fully pin and feature compatible
- Horizontal migration to the left reduces the pin count and therefore the available features

Figure 1. AVR® DB Family Overview

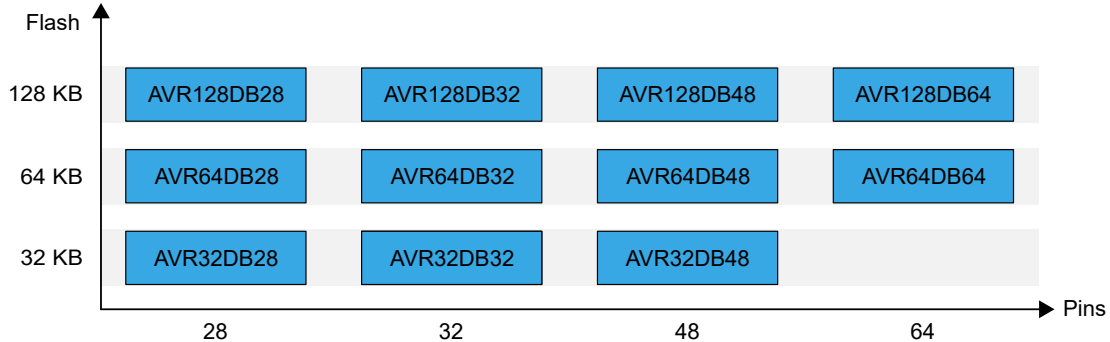

The name of a device in the AVR® DB Family is decoded as follows:

Figure 2. AVR® DB Family Device Designation

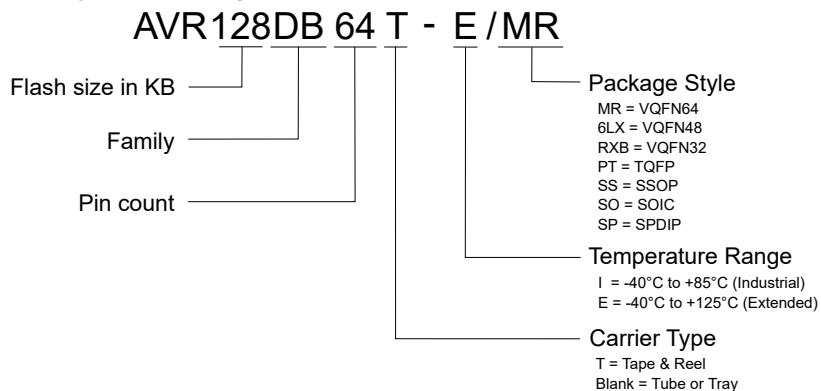

Memory Overview

Table 1. Memory Overview

Devices	AVR32DB28 AVR32DB32 AVR32DB48	AVR64DB28 AVR64DB32 AVR64DB48 AVR64DB64	AVR128DB28 AVR128DB32 AVR128DB48 AVR128DB64
Flash memory	32 KB	64 KB	128 KB
SRAM	4 KB	8 KB	16 KB
EEPROM	512B	512B	512B
User row	32B	32B	32B

Peripheral Overview

Table 2. Peripheral Overview

Feature	AVR32DB28 AVR64DB28 AVR128DB28	AVR32DB32 AVR64DB32 AVR128DB32	AVR32DB48 AVR64DB48 AVR128DB48	AVR64DB64 AVR128DB64
Pins	28	32	48	64
Max. frequency (MHz)	24	24	24	24
16-bit Timer/Counter type A (TCA)	1	1	2	2
16-bit Timer/Counter type B (TCB)	3	3	4	5
12-bit Timer/Counter type D (TCD)	1	1	1	1
Real-Time Counter (RTC)	1	1	1	1
USART	3	3	5	6
SPI	2	2	2	2
TWI/I ² C	1 ⁽¹⁾	2 ⁽¹⁾	2 ⁽¹⁾	2 ⁽¹⁾
12-bit differential ADC (channels)	1 (9)	1 (13)	1 (18)	1 (22)
10-bit DAC (outputs)	1 (1)	1 (1)	1 (1)	1 (1)
Analog Comparator (AC)	3	3	3	3
Zero-Cross Detector (ZCD)	1	1	2	3
Peripheral Touch Controller (PTC)	-	-	-	-
Op amp (OP)	2	2	3	3
Configurable Custom Logic Look-up Table (CCL LUT)	4	4	6	6
Watchdog Timer (WDT)	1	1	1	1
Event System channels (EVSYS)	8	8	10	10
General Purpose I/O ⁽²⁾	22/21 ⁽²⁾	26/25 ⁽²⁾	41/40 ⁽²⁾	55/54 ⁽²⁾

.....continued				
Feature	AVR32DB28 AVR64DB28 AVR128DB28	AVR32DB32 AVR64DB32 AVR128DB32	AVR32DB48 AVR64DB48 AVR128DB48	AVR64DB64 AVR128DB64
Pins	28	32	48	64
PORT	PA[7:0] PC[3:0] PD[7:1] PF[6,1,0]	PA[7:0] PC[3:0] PD[7:1] PF[6:0]	PA[7:0] PB[5:0] PC[7:0] PD[7:0] PE[3:0] PF[6:0]	PA[7:0] PB[7:0] PC[7:0] PD[7:0] PE[7:0] PF[6:0] PG[7:0]
External Interrupts	22	26	41	55
CRCSCAN	1	1	1	1
Unified Program and Debug Interface (UPDI)	1	1	1	1

Notes:

1. The TWI/I²C can operate simultaneously as host and client on different pins.
2. PF6/RESET pin is input only.

Features

- AVR® CPU
 - Running at up to 24 MHz
 - Single-cycle I/O register access
 - Two-level interrupt controller
 - Two-cycle hardware multiplier
 - Supply voltage range: 1.8V-5.5V
- Memories
 - 32/64/128 KB In-System self-programmable Flash memory
 - 512B EEPROM
 - 4/8/16 KB SRAM
 - 32B of user row in nonvolatile memory that can keep data during chip-erase and be programmed while the device is locked
 - Write/erase endurance
 - Flash: 10,000 cycles
 - EEPROM: 100,000 cycles
 - Data retention: 40 Years at 55°C
- System
 - Power-on Reset (POR) circuit
 - Brown-out Detector (BOD) with user-programmable levels
 - Voltage Level Monitor (VLM) with interrupt at a programmable level above the BOD level
 - Clock failure detection
 - Clock options
 - High-precision internal oscillator with selectable frequency up to 24 MHz (OSCHF)
 - Auto-tuning for improved internal oscillator accuracy
 - Internal PLL up to 48 MHz for high-frequency operation of Timer/Counter type D (PLL)
 - Internal ultra-low power 32.768 kHz oscillator (OSC32K)
 - External 32.768 kHz crystal oscillator (XOSC32K)
 - External clock input
 - External high-frequency crystal oscillator (XOSCHF) with clock failure detection
 - Single pin Unified Program and Debug Interface (UPDI)
 - Three sleep modes
 - Idle with all peripherals running for immediate wake-up
 - Standby
 - Configurable operation of selected peripherals
 - SleepWalking peripherals
 - Power-Down with full data retention
- Peripherals
 - Up to two 16-bit Timer/Counters type A (TCA) with three compare channels for PWM and waveform generation
 - Up to five 16-bit Timer/Counters type B (TCB) with input capture for capture and signal measurements
 - One 12-bit PWM Timer/Counter type D (TCD) optimized for power control
 - One 16-bit Real-Time Counter (RTC) that can run from external crystal or internal oscillator
 - Up to six USARTs
 - Operation modes: RS-485, LIN client, host SPI, and IrDA
 - Fractional baud rate generator, auto-baud, and start-of-frame detection
 - Two SPIs with host/client operation modes
 - Up to two Two-Wire Interface (TWI) with dual address match
 - Independent host and client operation (Dual mode)

- Phillips I²C compatible
- Standard mode (Sm, 100 kHz)
- Fast mode (Fm, 400 kHz)
- Fast mode plus (Fm+, 1 MHz)⁽¹⁾
- Event System for CPU independent and predictable inter-peripheral signaling
- Configurable Custom Logic (CCL) with up to six programmable Look-up Tables (LUTs)
- One 12-bit 130 kps differential Analog-to-Digital Converter (ADC)
- Three Analog Comparators (ACs) with window compare functions
- One 10-bit Digital-to-Analog Converter (DAC)
- Up to three Zero-Cross Detectors (ZCDs)
- Analog Signal Conditioning (OPAMP) peripheral with up to three op amps, each with an internal resistor ladder that allows for many useful configurations with no external components
- Multiple voltage references (VREF)
 - 1.024V
 - 2.048V
 - 2.500V
 - 4.096V
 - External Voltage Reference (VREFA)
 - Supply Voltage (V_{DD})
- Automated Cyclic Redundancy Check (CRC) Flash program memory scan
- Watchdog Timer (WDT) with Window mode, and separate on-chip oscillator
- External interrupt on all general purpose pins
- I/O and Packages:
 - Multi-Voltage I/O (MVIO) on I/O port C
 - Selectable input voltage threshold
 - Up to 55/54 programmable I/O pins
 - 28-pin SSOP, SOIC and SPDIP
 - 32-pin VQFN 5x5 mm and TQFP 7x7 mm
 - 48-pin VQFN 5x5 mm and TQFP 7x7 mm
 - 64-pin VQFN 9x9 mm and TQFP 10x10 mm
- Temperature Ranges
 - Industrial: -40°C to 85°C
 - Extended: -40°C to 125°C

Note:

1. I²C Fm+ is only supported for supply voltage V_{DD} above 2.7 VDC.

Table of Contents

Introduction.....	1
AVR® DB Family Overview.....	1
1. Memory Overview.....	2
2. Peripheral Overview.....	2
Features.....	4
1. Block Diagram.....	7
2. Pinout.....	8
2.1. 28-pin SSOP, SOIC and SPDIP.....	8
2.2. 32-pin VQFN and TQFP.....	9
2.3. 48-pin VQFN and TQFP.....	10
2.4. 64-pin VQFN and TQFP.....	11
3. I/O Multiplexing and Considerations.....	12
3.1. I/O Multiplexing.....	12
4. Product Brief Revision History.....	15
4.1. Revision History.....	15
The Microchip Website.....	16
Product Change Notification Service.....	16
Customer Support.....	16
Product Identification System.....	17
Microchip Devices Code Protection Feature.....	17
Legal Notice.....	17
Trademarks.....	18
Quality Management System.....	18
Worldwide Sales and Service.....	19

1. Block Diagram

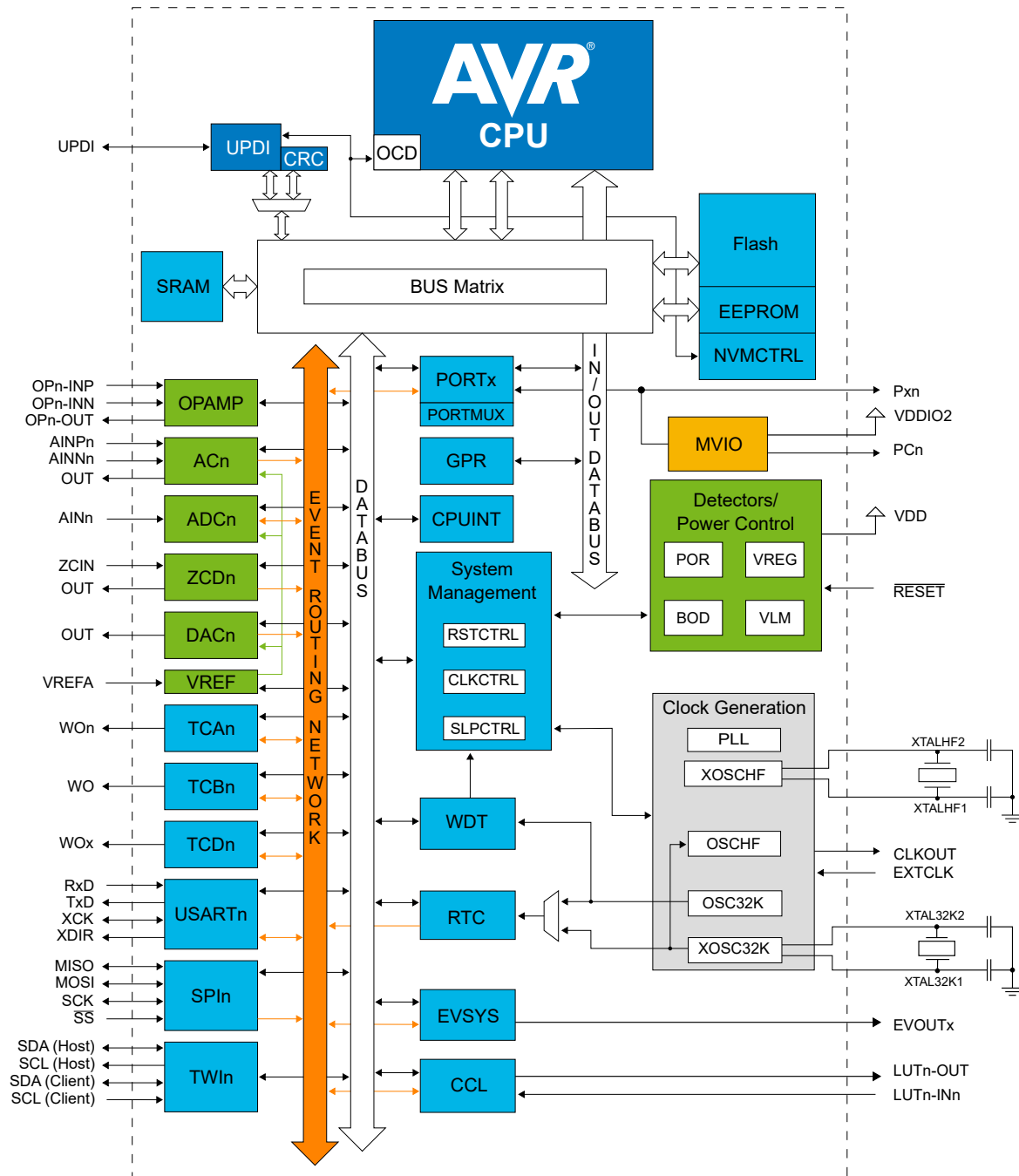

2. Pinout

2.1 28-pin SSOP, SOIC and SPDIP

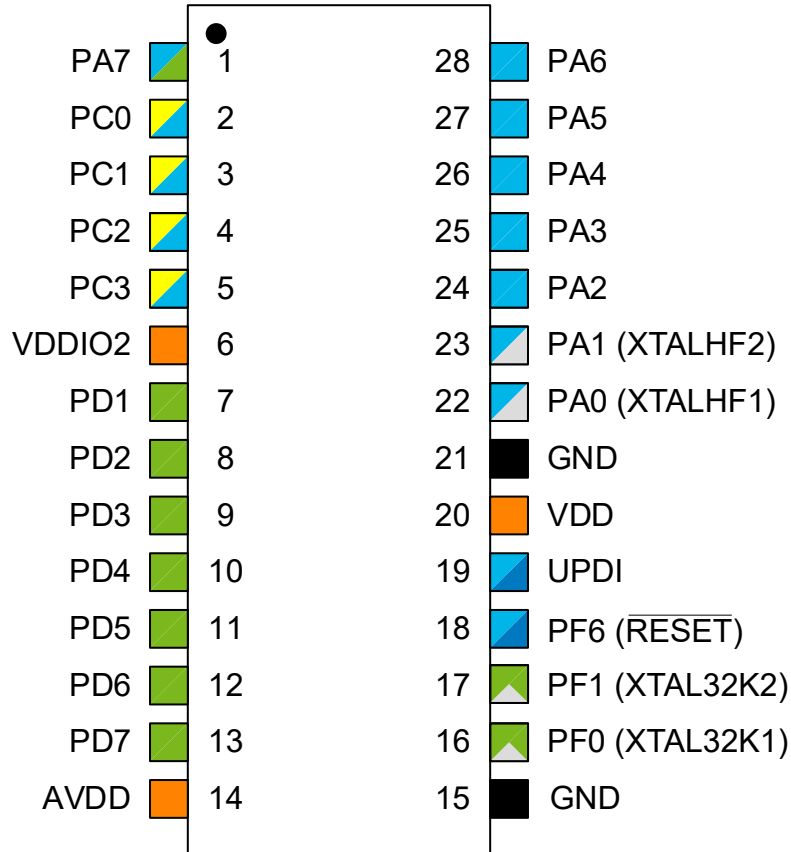

Note: For the AVR® DB Family of devices, AVDD is internally connected to VDD (not separate power domains).

Power

- Power Supply
- Ground
- Pin on VDD Power Domain
- Pin on AVDD Power Domain
- Pin on VDDIO2 Power Domain







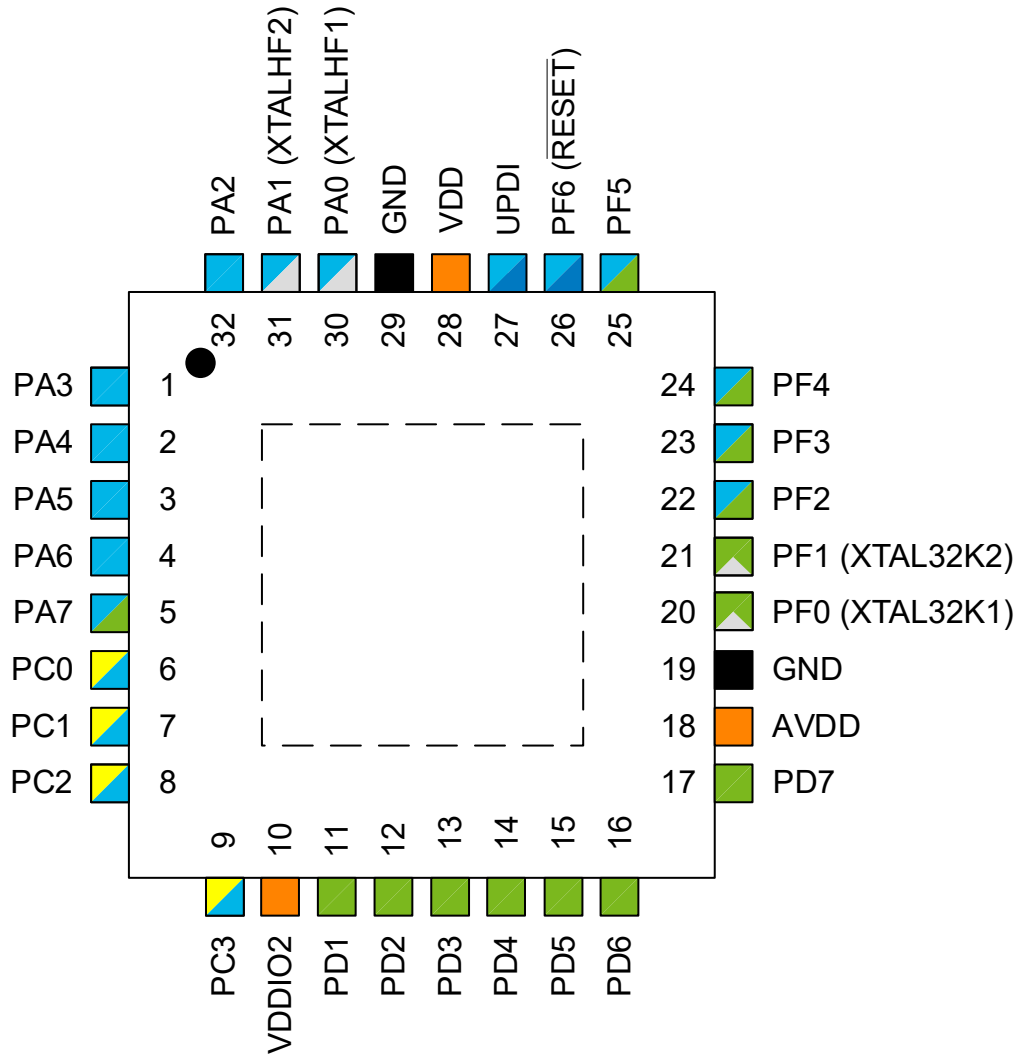

Functionality

- Programming/Debug
- Clock/Crystal
- Digital Function Only
- Analog Function

2.2 32-pin VQFN and TQFP



Note: For the AVR® DB Family of devices, AVDD is internally connected to VDD (not separate power domains).



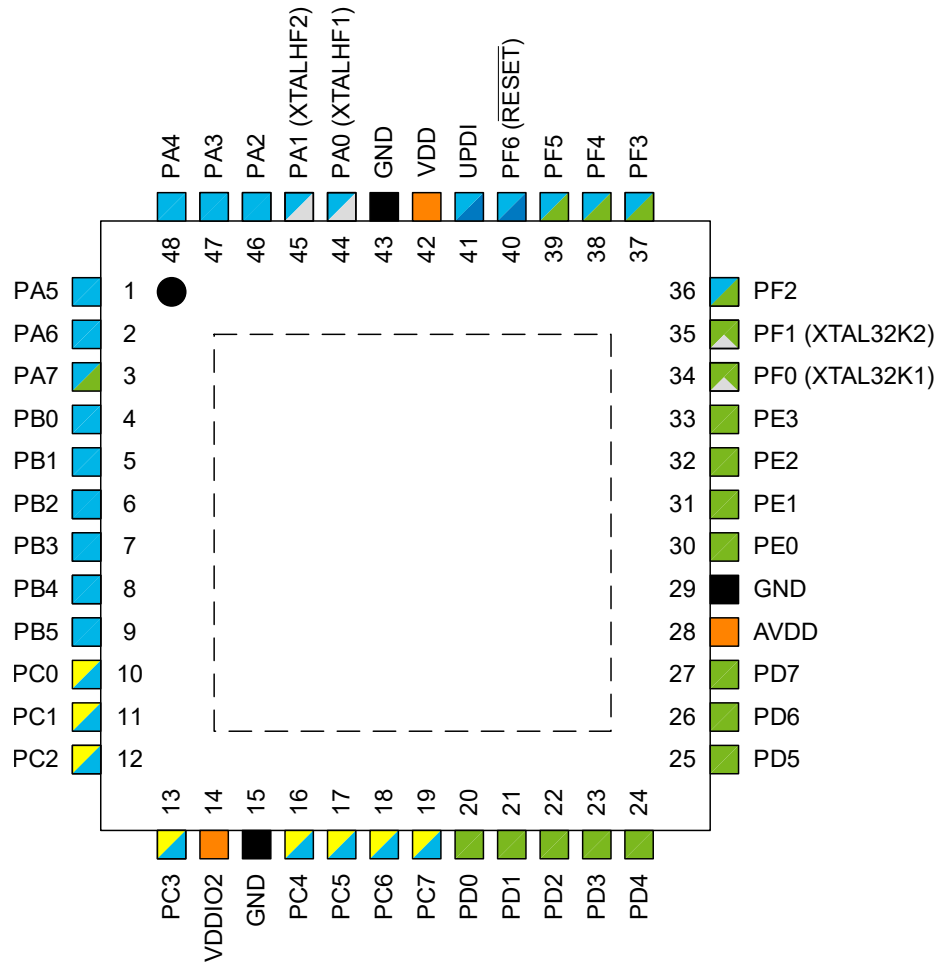

Power	Functionality
 Power Supply	 Programming/Debug
 Ground	 Clock/Crystal
 Pin on VDD Power Domain	 Digital Function Only
 Pin on AVDD Power Domain	 Analog Function
 Pin on VDDIO2 Power Domain	

2.3 48-pin VQFN and TQFP







Note: For the AVR® DB Family of devices, AVDD is internally connected to VDD (not separate power domains).

Power

-  Power Supply
-  Ground
-  Pin on VDD Power Domain
-  Pin on AVDD Power Domain
-  Pin on VDDIO2 Power Domain

Functionality

-  Programming/Debug
-  Clock/Crystal
-  Digital Function Only
-  Analog Function

2.4 64-pin VQFN and TQFP

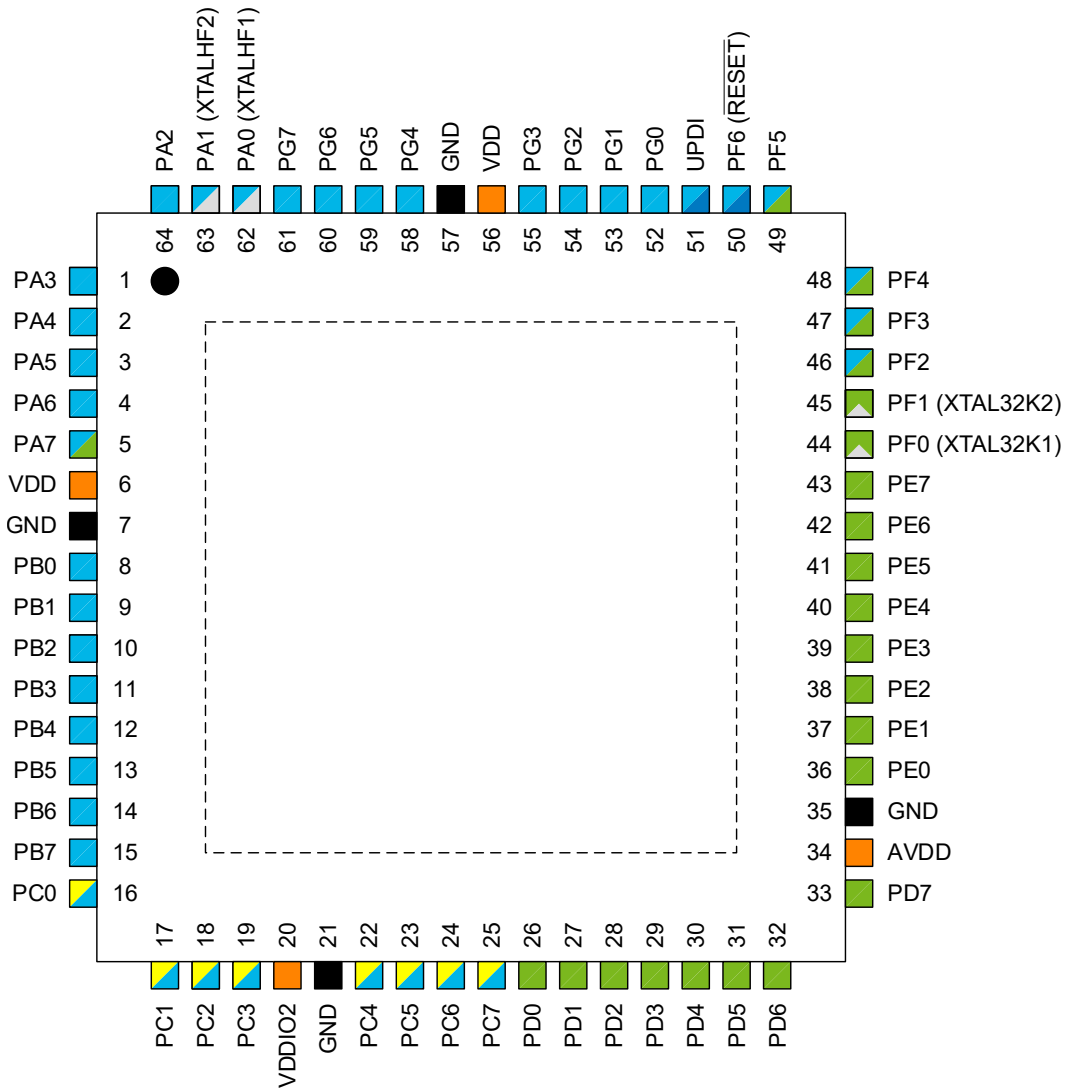

Note: For the AVR® DB Family of devices, AVDD is internally connected to VDD (not separate power domains).

Power

- Power Supply
- Ground
- Pin on VDD Power Domain
- Pin on AVDD Power Domain
- Pin on VDDIO2 Power Domain

Functionality

- Programming/Debug
- Clock/Crystal
- Digital Function Only
- Analog Function

3. I/O Multiplexing and Considerations

3.1 I/O Multiplexing

VQFN64/ TQFP64	VQFN48/ TQFP48	VQFN32/ TQFP32	SOIC28/ SSOP28/SPDIP28	Pin name ^(1,2)	Special	ADC0	ACn	DAC0	OPAMP	Zcdn	USARTn	SPI _n	TWIn ⁽⁴⁾	TCAn	TCBn	TCD0	EVSYS	CCL
62	44	30	22	PA0	XTALHF1 EXTCLK						0, TxD			0, WO0				LUT0, IN0
63	45	31	23	PA1	XTALHF2						0, RxD			0, WO1				LUT0, IN1
64	46	32	24	PA2	TWI Fm+						0, XCK		0, SDA(HC)	0, WO2	0, WO		EVOUTA	LUT0, IN2
1	47	1	25	PA3	TWI Fm+						0, XDIR		0, SCL(HC)	0, WO3	1, WO			LUT0, OUT
2	48	2	26	PA4							0, TxD ⁽³⁾	0, MOSI		0, WO4		WOA		
3	1	3	27	PA5							0, RxD ⁽³⁾	0, MISO		0, WO5		WOB		
4	2	4	28	PA6							0, XCK ⁽³⁾	0, SCK				WOC		LUT0, OUT ⁽³⁾
5	3	5	1	PA7	CLKOUT		0, OUT 1, OUT 2, OUT			0, OUT 1, OUT 2, OUT	0, XDIR ⁽³⁾	0, SS				WOD	EVOUTA ⁽³⁾	
6				VDD														
7				GND														
8	4			PB0							3, TxD			0, WO0 ⁽³⁾ 1, WO0				LUT4, IN0
9	5			PB1							3, RxD			0, WO1 ⁽³⁾ 1, WO1				LUT4, IN1
10	6			PB2	TWI						3, XCK		1, SDA(HC) (3)	0, WO2 ⁽³⁾ 1, WO2			EVOUTB	LUT4, IN2
11	7			PB3	TWI						3, XDIR		1, SCL(HC) (3)	0, WO3 ⁽³⁾ 1, WO3				LUT4, OUT
12	8			PB4							3, TxD ⁽³⁾	1, MOSI ⁽³⁾		0, WO4 ⁽³⁾ 1, WO4	2, WO ⁽³⁾	WOA ⁽³⁾		
13	9			PB5							3, RxD ⁽³⁾	1, MISO ⁽³⁾		0, WO5 ⁽³⁾ 1, WO5	3, WO	WOB ⁽³⁾		
14				PB6							3, XCK ⁽³⁾	1, SCK ⁽³⁾	1, SDA(C) (3)			WOC ⁽³⁾		LUT4, OUT ⁽³⁾
15				PB7							3, XDIR ⁽³⁾	1, SS ⁽³⁾	1, SCL(C) ⁽³⁾			WOD ⁽³⁾	EVOUTB ⁽³⁾	
16	10	6	2	PC0							1, TxD	1, MOSI		0, WO0 ⁽³⁾	2, WO			LUT1, IN0
17	11	7	3	PC1							1, RxD	1, MISO		0, WO1 ⁽³⁾	3, WO ⁽³⁾			LUT1, IN1
18	12	8	4	PC2	TWI Fm+						1, XCK	1, SCK	0, SDA(HC) (3)	0, WO2 ⁽³⁾			EVOUTC	LUT1, IN2
19	13	9	5	PC3	TWI Fm+						1, XDIR	1, SS	0, SCL(HC) (3)	0, WO3 ⁽³⁾				LUT1, OUT
20	14	10	6	VDDIO2														
21	15			GND														
22	16			PC4							1, TxD ⁽³⁾	1, MOSI ⁽³⁾		0, WO4 ⁽³⁾ 1, WO0 ⁽³⁾				
23	17			PC5							1, RxD ⁽³⁾	1, MISO ⁽³⁾		0, WO5 ⁽³⁾ 1, WO1 ⁽³⁾				
24	18			PC6			0, OUT ⁽³⁾ 1, OUT ⁽³⁾ 2, OUT ⁽³⁾				1, XCK ⁽³⁾	1, SCK ⁽³⁾	0, SDA(C) (3)	1, WO2 ⁽³⁾				LUT1, OUT ⁽³⁾

.....continued

VQFN64/ TQFP64	VQFN48/ TQFP48	VQFN32/ TQFP32	SOIC28/ SSOP28/SPDIP28	Pin name(1,2)	Special	ADC0	ACn	DAC0	OPAMP	ZCDn	USARTn	SPI n	TWI n(4)	TCA n	TCBn	TCDO	EVSYS	CCL		
25	19			PC7						0, OUT(3) 1, OUT(3) 2, OUT(3)	1, XDIR(3)	1, SS(3)	0, SCL(C)(3)					EVOUTC(3)		
26	20			PD0		AIN0	0, AINN1 1, AINN1 2, AINN1							0, WO0(3)					LUT2, IN0	
27	21	11	7	PD1		AIN1			OP0, INP	0, ZCIN				0, WO1(3)					LUT2, IN1	
28	22	12	8	PD2		AIN2	0, AINP0 1, AINP0 2, AINP0		OP0, OUT					0, WO2(3)				EVOUTD	LUT2, IN2	
29	23	13	9	PD3		AIN3	0, AINN0 1, AINP1		OP0, INN					0, WO3(3)					LUT2, OUT	
30	24	14	10	PD4		AIN4	1, AINP2 2, AINP1		OP1, INP					0, WO4(3)						
31	25	15	11	PD5		AIN5	1, AINN0		OP1, OUT					0, WO5(3)						
32	26	16	12	PD6		AIN6	0, AINP3 1, AINP3 2, AINP3	OUT											LUT2, OUT(3)	
33	27	17	13	PD7	VREFA	AIN7	0, AINN2 1, AINN2 2, AINN0/ AINN2		OP1, INN										EVOUTD(3)	
34	28	18	14	AVDD																
35	29	19	15	AGND																
36	30			PE0		AIN8	0, AINP1				4, TxD	0, MOSI(3)		0, WO0(3)						
37	31			PE1		AIN9	2, AINP2		OP2, INP		4, RxD	0, MISO(3)		0, WO1(3)						
38	32			PE2		AIN10	0, AINP2		OP2, OUT		4, XCK	0, SCK(3)		0, WO2(3)					EVOUTE	
39	33			PE3		AIN11			OP2, INN	1, ZCIN	4, XDIR	0, SS(3)		0, WO3(3)						
40				PE4		AIN12					4, TxD(3)			0, WO4(3) 1, WO0(3)						
41				PE5		AIN13					4, RxD(3)			0, WO5(3) 1, WO1(3)						
42				PE6		AIN14					4, XCK(3)			1, WO2(3)						
43				PE7		AIN15				2, ZCIN	4, XDIR(3)								EVOUTE(3)	
44	34	20	16	PF0	XTAL32K1	AIN16(5)					2, TxD			0, WO0(3)				WOA(3)	LUT3, IN0	
45	35	21	17	PF1	XTAL32K2	AIN17(5)					2, RxD			0, WO1(3)				WOB(3)	LUT3, IN1	
46	36	22		PF2	TWI Fm+	AIN18(5)					2, XCK		1, SDA(HC)	0, WO2(3)				WOC(3)	EVOUTF	LUT3, IN2
47	37	23		PF3	TWI Fm+	AIN19(5)					2, XDIR		1, SCL(HC)	0, WO3(3)				WOD(3)	LUT3, OUT	
48	38	24		PF4		AIN20(5)					2, TxD(3)			0, WO4(3) 0, WO(3)						
49	39	25		PF5		AIN21(5)					2, RxD(3)			0, WO5(3) 1, WO(3)						
50	40	26	18	PF6(6)	RESET															
51	41	27	19	UPDI	UPDI															

.....continued

VQFN64/ TQFP64	VQFN48/ TQFP48	VQFN32/ TQFP32	SOIC28/ SSOP28/SPDIP28	Pin name(1,2)	Special	ADC0	ACn	DAC0	OPAMP	ZCDn	USARTn	SPI _n	TWI _n (4)	TCA _n	TCB _n	TCD0	EVSYS	CCL
52				PG0							5, TxD			0, WO0 ⁽³⁾ 1, WO0 ⁽³⁾				LUT5, IN0
53				PG1							5, RxD			0, WO1 ⁽³⁾ 1, WO1 ⁽³⁾				LUT5, IN1
54				PG2							5, XCK			0, WO2 ⁽³⁾ 1, WO2 ⁽³⁾			EVOUTG	LUT5, IN2
55				PG3							5, XDIR			0, WO3 ⁽³⁾ 1, WO3 ⁽³⁾	4, WO			LUT5, OUT
56	42	28	20	VDD														
57	43	29	21	GND														
58				PG4							5, TxD ⁽³⁾	0, MOSI ⁽³⁾		0, WO4 ⁽³⁾ 1, WO4 ⁽³⁾			WOA ⁽³⁾	
59				PG5							5, RxD ⁽³⁾	0, MISO ⁽³⁾		0, WO5 ⁽³⁾ 1, WO5 ⁽³⁾			WOB ⁽³⁾	
60				PG6							5, XCK ⁽³⁾	0, SCK ⁽³⁾					WOC ⁽³⁾	LUT5, OUT ⁽³⁾
61				PG7							5, XDIR ⁽³⁾	0, SS ⁽³⁾					WOD ⁽³⁾	EVOUTG ⁽³⁾

Notes:

1. Pin names are of type P_xn, with *x* being the PORT instance (A, B, C, ...) and *n* the pin number. Notation for signals is PORT_x_PIN_n. All pins can be used as event inputs.
2. All pins can be used for external interrupt, where pins P_x2 and P_x6 of each port have full asynchronous detection.
3. Alternative pin positions.
4. TWI pins are marked *HC* if they can be used as TWI Host or Client pins, and *C* if they can only be used as TWI Client pins.
5. AIN16 - AIN21 cannot be used as a negative ADC input for differential measurements.
6. Input only.

4. Product Brief Revision History

Note: The product brief revision is independent of the die revision and the device variant (last letter of the ordering number).

4.1 Revision History

Doc. Rev.	Date	Comments
B	10/2020	Updated the document to include the latest data sheet updates
A	11/2019	Initial release

The Microchip Website

Microchip provides online support via our website at www.microchip.com/. This website is used to make files and information easily available to customers. Some of the content available includes:

- **Product Support** – Data sheets and errata, application notes and sample programs, design resources, user's guides and hardware support documents, latest software releases and archived software
- **General Technical Support** – Frequently Asked Questions (FAQs), technical support requests, online discussion groups, Microchip design partner program member listing
- **Business of Microchip** – Product selector and ordering guides, latest Microchip press releases, listing of seminars and events, listings of Microchip sales offices, distributors and factory representatives

Product Change Notification Service

Microchip's product change notification service helps keep customers current on Microchip products. Subscribers will receive email notification whenever there are changes, updates, revisions or errata related to a specified product family or development tool of interest.

To register, go to www.microchip.com/pcn and follow the registration instructions.

Customer Support

Users of Microchip products can receive assistance through several channels:

- Distributor or Representative
- Local Sales Office
- Embedded Solutions Engineer (ESE)
- Technical Support

Customers should contact their distributor, representative or ESE for support. Local sales offices are also available to help customers. A listing of sales offices and locations is included in this document.

Technical support is available through the website at: www.microchip.com/support

Product Identification System

To order or obtain information, e.g., on pricing or delivery, refer to the factory or the listed sales office.

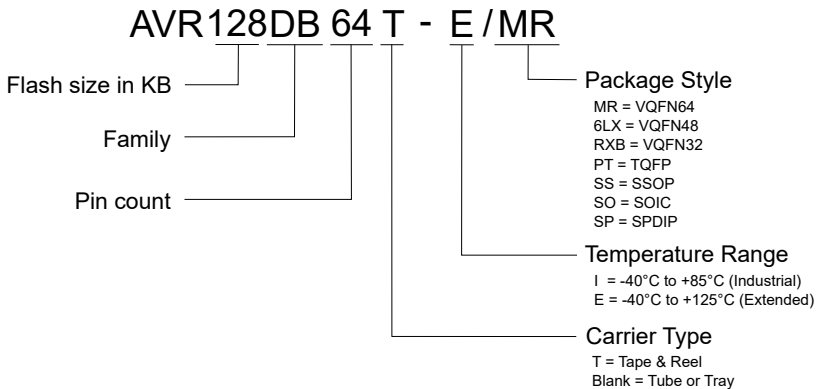

Note: Tape and Reel identifier only appears in the catalog part number description. This identifier is used for ordering purposes. Check with your Microchip Sales Office for package availability with the Tape and Reel option.

Microchip Devices Code Protection Feature

Note the following details of the code protection feature on Microchip devices:

- Microchip products meet the specifications contained in their particular Microchip Data Sheet.
- Microchip believes that its family of products is secure when used in the intended manner and under normal conditions.
- There are dishonest and possibly illegal methods being used in attempts to breach the code protection features of the Microchip devices. We believe that these methods require using the Microchip products in a manner outside the operating specifications contained in Microchip's Data Sheets. Attempts to breach these code protection features, most likely, cannot be accomplished without violating Microchip's intellectual property rights.
- Microchip is willing to work with any customer who is concerned about the integrity of its code.
- Neither Microchip nor any other semiconductor manufacturer can guarantee the security of its code. Code protection does not mean that we are guaranteeing the product is "unbreakable." Code protection is constantly evolving. We at Microchip are committed to continuously improving the code protection features of our products. Attempts to break Microchip's code protection feature may be a violation of the Digital Millennium Copyright Act. If such acts allow unauthorized access to your software or other copyrighted work, you may have a right to sue for relief under that Act.

Legal Notice

Information contained in this publication is provided for the sole purpose of designing with and using Microchip products. Information regarding device applications and the like is provided only for your convenience and may be superseded by updates. It is your responsibility to ensure that your application meets with your specifications.

THIS INFORMATION IS PROVIDED BY MICROCHIP "AS IS". MICROCHIP MAKES NO REPRESENTATIONS OR WARRANTIES OF ANY KIND WHETHER EXPRESS OR IMPLIED, WRITTEN OR ORAL, STATUTORY OR OTHERWISE, RELATED TO THE INFORMATION INCLUDING BUT NOT LIMITED TO ANY IMPLIED WARRANTIES OF NON-INFRINGEMENT, MERCHANTABILITY, AND FITNESS FOR A PARTICULAR PURPOSE OR WARRANTIES RELATED TO ITS CONDITION, QUALITY, OR PERFORMANCE.

IN NO EVENT WILL MICROCHIP BE LIABLE FOR ANY INDIRECT, SPECIAL, PUNITIVE, INCIDENTAL OR CONSEQUENTIAL LOSS, DAMAGE, COST OR EXPENSE OF ANY KIND WHATSOEVER RELATED TO THE INFORMATION OR ITS USE, HOWEVER CAUSED, EVEN IF MICROCHIP HAS BEEN ADVISED OF THE POSSIBILITY OR THE DAMAGES ARE FORESEEABLE. TO THE FULLEST EXTENT ALLOWED BY LAW, MICROCHIP'S TOTAL LIABILITY ON ALL CLAIMS IN ANY WAY RELATED TO THE INFORMATION OR ITS USE WILL NOT EXCEED THE AMOUNT OF FEES, IF ANY, THAT YOU HAVE PAID DIRECTLY TO MICROCHIP FOR

THE INFORMATION. Use of Microchip devices in life support and/or safety applications is entirely at the buyer's risk, and the buyer agrees to defend, indemnify and hold harmless Microchip from any and all damages, claims, suits, or expenses resulting from such use. No licenses are conveyed, implicitly or otherwise, under any Microchip intellectual property rights unless otherwise stated.

Trademarks

The Microchip name and logo, the Microchip logo, Adaptec, AnyRate, AVR, AVR logo, AVR Freaks, BesTime, BitCloud, chipKIT, chipKIT logo, CryptoMemory, CryptoRF, dsPIC, FlashFlex, flexPWR, HELDO, IGLOO, JukeBlox, KeeLoq, Klear, LANCheck, LinkMD, maXStylus, maXTouch, MediaLB, megaAVR, Microsemi, Microsemi logo, MOST, MOST logo, MPLAB, OptoLyzer, PackeTime, PIC, picoPower, PICSTART, PIC32 logo, PolarFire, Prochip Designer, QTouch, SAM-BA, SenGenuity, SpyNIC, SST, SST Logo, SuperFlash, Symmetricom, SyncServer, Tachyon, TimeSource, tinyAVR, UNI/O, Vectron, and XMEGA are registered trademarks of Microchip Technology Incorporated in the U.S.A. and other countries.

AgileSwitch, APT, ClockWorks, The Embedded Control Solutions Company, EtherSynch, FlashTec, Hyper Speed Control, HyperLight Load, IntelliMOS, Libero, motorBench, mTouch, Powermite 3, Precision Edge, ProASIC, ProASIC Plus, ProASIC Plus logo, Quiet-Wire, SmartFusion, SyncWorld, Temux, TimeCesium, TimeHub, TimePictra, TimeProvider, WinPath, and ZL are registered trademarks of Microchip Technology Incorporated in the U.S.A.

Adjacent Key Suppression, AKS, Analog-for-the-Digital Age, Any Capacitor, AnyIn, AnyOut, Augmented Switching, BlueSky, BodyCom, CodeGuard, CryptoAuthentication, CryptoAutomotive, CryptoCompanion, CryptoController, dsPICDEM, dsPICDEM.net, Dynamic Average Matching, DAM, ECAN, Espresso T1S, EtherGREEN, IdealBridge, In-Circuit Serial Programming, ICSP, INICnet, Intelligent Paralleling, Inter-Chip Connectivity, JitterBlocker, maxCrypto, maxView, memBrain, Mindi, MiWi, MPASM, MPF, MPLAB Certified logo, MPLIB, MPLINK, MultiTRAK, NetDetach, Omniscient Code Generation, PICDEM, PICDEM.net, PICKit, PICtail, PowerSmart, PureSilicon, QMatrix, REAL ICE, Ripple Blocker, RTAX, RTG4, SAM-ICE, Serial Quad I/O, simpleMAP, SimpliPHY, SmartBuffer, SMART-I.S., storClad, SQI, SuperSwitcher, SuperSwitcher II, Switchtec, SynchronPHY, Total Endurance, TSHARC, USBCheck, VariSense, VectorBlox, VeriPHY, ViewSpan, WiperLock, XpressConnect, and ZENA are trademarks of Microchip Technology Incorporated in the U.S.A. and other countries.

SQTP is a service mark of Microchip Technology Incorporated in the U.S.A.

The Adaptec logo, Frequency on Demand, Silicon Storage Technology, and Symmcom are registered trademarks of Microchip Technology Inc. in other countries.

GestIC is a registered trademark of Microchip Technology Germany II GmbH & Co. KG, a subsidiary of Microchip Technology Inc., in other countries.

All other trademarks mentioned herein are property of their respective companies.

© 2020, Microchip Technology Incorporated, Printed in the U.S.A., All Rights Reserved.

ISBN: 978-1-5224-6905-6

Quality Management System

For information regarding Microchip's Quality Management Systems, please visit www.microchip.com/quality.

Worldwide Sales and Service

AMERICAS	ASIA/PACIFIC	ASIA/PACIFIC	EUROPE
<p>Corporate Office 2355 West Chandler Blvd. Chandler, AZ 85224-6199 Tel: 480-792-7200 Tel: 480-792-7277 Technical Support: www.microchip.com/support Web Address: www.microchip.com</p> <p>Atlanta Duluth, GA Tel: 678-957-9614 Fax: 678-957-1455</p> <p>Austin, TX Tel: 512-257-3370</p> <p>Boston Westborough, MA Tel: 774-760-0087 Fax: 774-760-0088</p> <p>Chicago Itasca, IL Tel: 630-285-0071 Fax: 630-285-0075</p> <p>Dallas Addison, TX Tel: 972-818-7423 Fax: 972-818-2924</p> <p>Detroit Novi, MI Tel: 248-848-4000</p> <p>Houston, TX Tel: 281-894-5983</p> <p>Indianapolis Noblesville, IN Tel: 317-773-8323 Fax: 317-773-5453 Tel: 317-536-2380</p> <p>Los Angeles Mission Viejo, CA Tel: 949-462-9523 Fax: 949-462-9608 Tel: 951-273-7800</p> <p>Raleigh, NC Tel: 919-844-7510</p> <p>New York, NY Tel: 631-435-6000</p> <p>San Jose, CA Tel: 408-735-9110 Tel: 408-436-4270</p> <p>Canada - Toronto Tel: 905-695-1980 Fax: 905-695-2078</p>	<p>Australia - Sydney Tel: 61-2-9868-6733</p> <p>China - Beijing Tel: 86-10-8569-7000</p> <p>China - Chengdu Tel: 86-28-8665-5511</p> <p>China - Chongqing Tel: 86-23-8980-9588</p> <p>China - Dongguan Tel: 86-769-8702-9880</p> <p>China - Guangzhou Tel: 86-20-8755-8029</p> <p>China - Hangzhou Tel: 86-571-8792-8115</p> <p>China - Hong Kong SAR Tel: 852-2943-5100</p> <p>China - Nanjing Tel: 86-25-8473-2460</p> <p>China - Qingdao Tel: 86-532-8502-7355</p> <p>China - Shanghai Tel: 86-21-3326-8000</p> <p>China - Shenyang Tel: 86-24-2334-2829</p> <p>China - Shenzhen Tel: 86-755-8864-2200</p> <p>China - Suzhou Tel: 86-186-6233-1526</p> <p>China - Wuhan Tel: 86-27-5980-5300</p> <p>China - Xian Tel: 86-29-8833-7252</p> <p>China - Xiamen Tel: 86-592-2388138</p> <p>China - Zhuhai Tel: 86-756-3210040</p>	<p>India - Bangalore Tel: 91-80-3090-4444</p> <p>India - New Delhi Tel: 91-11-4160-8631</p> <p>India - Pune Tel: 91-20-4121-0141</p> <p>Japan - Osaka Tel: 81-6-6152-7160</p> <p>Japan - Tokyo Tel: 81-3-6880-3770</p> <p>Korea - Daegu Tel: 82-53-744-4301</p> <p>Korea - Seoul Tel: 82-2-554-7200</p> <p>Malaysia - Kuala Lumpur Tel: 60-3-7651-7906</p> <p>Malaysia - Penang Tel: 60-4-227-8870</p> <p>Philippines - Manila Tel: 63-2-634-9065</p> <p>Singapore Tel: 65-6334-8870</p> <p>Taiwan - Hsin Chu Tel: 886-3-577-8366</p> <p>Taiwan - Kaohsiung Tel: 886-7-213-7830</p> <p>Taiwan - Taipei Tel: 886-2-2508-8600</p> <p>Thailand - Bangkok Tel: 66-2-694-1351</p> <p>Vietnam - Ho Chi Minh Tel: 84-28-5448-2100</p>	<p>Austria - Wels Tel: 43-7242-2244-39 Fax: 43-7242-2244-393</p> <p>Denmark - Copenhagen Tel: 45-4485-5910 Fax: 45-4485-2829</p> <p>Finland - Espoo Tel: 358-9-4520-820</p> <p>France - Paris Tel: 33-1-69-53-63-20 Fax: 33-1-69-30-90-79</p> <p>Germany - Garching Tel: 49-8931-9700</p> <p>Germany - Haan Tel: 49-2129-3766400</p> <p>Germany - Heilbronn Tel: 49-7131-72400</p> <p>Germany - Karlsruhe Tel: 49-721-625370</p> <p>Germany - Munich Tel: 49-89-627-144-0 Fax: 49-89-627-144-44</p> <p>Germany - Rosenheim Tel: 49-8031-354-560</p> <p>Israel - Ra'anana Tel: 972-9-744-7705</p> <p>Italy - Milan Tel: 39-0331-742611 Fax: 39-0331-466781</p> <p>Italy - Padova Tel: 39-049-7625286</p> <p>Netherlands - Druenen Tel: 31-416-690399 Fax: 31-416-690340</p> <p>Norway - Trondheim Tel: 47-72884388</p> <p>Poland - Warsaw Tel: 48-22-3325737</p> <p>Romania - Bucharest Tel: 40-21-407-87-50</p> <p>Spain - Madrid Tel: 34-91-708-08-90 Fax: 34-91-708-08-91</p> <p>Sweden - Gothenberg Tel: 46-31-704-60-40</p> <p>Sweden - Stockholm Tel: 46-8-5090-4654</p> <p>UK - Wokingham Tel: 44-118-921-5800 Fax: 44-118-921-5820</p>

Mouser Electronics

Authorized Distributor

Click to View Pricing, Inventory, Delivery & Lifecycle Information:

Microchip:

[AVR32DB32-E/PT](#) [AVR32DB32-E/RXB](#) [AVR32DB32-I/PT](#) [AVR32DB32-I/RXB](#) [AVR32DB32T-E/PT](#) [AVR32DB32T-E/RXB](#) [AVR32DB32T-I/PT](#) [AVR32DB32T-I/RXB](#) [AVR32DB48-E/6LX](#) [AVR32DB48-E/PT](#) [AVR32DB48-I/6LX](#) [AVR32DB48-I/PT](#) [AVR32DB48T-E/6LX](#) [AVR32DB48T-E/PT](#) [AVR32DB48T-I/6LX](#) [AVR32DB48T-I/PT](#) [AVR64DB48-E/6LX](#) [AVR64DB48-E/PT](#) [AVR64DB48-I/6LX](#) [AVR64DB48-I/PT](#) [AVR64DB48T-E/6LX](#) [AVR64DB48T-E/PT](#) [AVR64DB48T-I/6LX](#) [AVR64DB48T-I/PT](#) [AVR64DB64-E/MR](#) [AVR64DB64-E/PT](#) [AVR64DB64-I/MR](#) [AVR64DB64-I/PT](#) [AVR64DB64T-E/MR](#) [AVR64DB64T-E/PT](#) [AVR64DB64T-I/MR](#) [AVR64DB64T-I/PT](#)