



MICROCHIP

CL88020
120 V_{AC} Offline LED Driver
Evaluation Board
User's Guide

Note the following details of the code protection feature on Microchip devices:

- Microchip products meet the specification contained in their particular Microchip Data Sheet.
- Microchip believes that its family of products is one of the most secure families of its kind on the market today, when used in the intended manner and under normal conditions.
- There are dishonest and possibly illegal methods used to breach the code protection feature. All of these methods, to our knowledge, require using the Microchip products in a manner outside the operating specifications contained in Microchip's Data Sheets. Most likely, the person doing so is engaged in theft of intellectual property.
- Microchip is willing to work with the customer who is concerned about the integrity of their code.
- Neither Microchip nor any other semiconductor manufacturer can guarantee the security of their code. Code protection does not mean that we are guaranteeing the product as "unbreakable."

Code protection is constantly evolving. We at Microchip are committed to continuously improving the code protection features of our products. Attempts to break Microchip's code protection feature may be a violation of the Digital Millennium Copyright Act. If such acts allow unauthorized access to your software or other copyrighted work, you may have a right to sue for relief under that Act.

Information contained in this publication regarding device applications and the like is provided only for your convenience and may be superseded by updates. It is your responsibility to ensure that your application meets with your specifications. MICROCHIP MAKES NO REPRESENTATIONS OR WARRANTIES OF ANY KIND WHETHER EXPRESS OR IMPLIED, WRITTEN OR ORAL, STATUTORY OR OTHERWISE, RELATED TO THE INFORMATION, INCLUDING BUT NOT LIMITED TO ITS CONDITION, QUALITY, PERFORMANCE, MERCHANTABILITY OR FITNESS FOR PURPOSE. Microchip disclaims all liability arising from this information and its use. Use of Microchip devices in life support and/or safety applications is entirely at the buyer's risk, and the buyer agrees to defend, indemnify and hold harmless Microchip from any and all damages, claims, suits, or expenses resulting from such use. No licenses are conveyed, implicitly or otherwise, under any Microchip intellectual property rights unless otherwise stated.

Microchip received ISO/TS-16949:2009 certification for its worldwide headquarters, design and wafer fabrication facilities in Chandler and Tempe, Arizona; Gresham, Oregon and design centers in California and India. The Company's quality system processes and procedures are for its PIC® MCUs and dsPIC® DSCs, KEELOQ® code hopping devices, Serial EEPROMs, microperipherals, nonvolatile memory and analog products. In addition, Microchip's quality system for the design and manufacture of development systems is ISO 9001:2000 certified.

**QUALITY MANAGEMENT SYSTEM
CERTIFIED BY DNV
= ISO/TS 16949 =**

Trademarks

The Microchip name and logo, the Microchip logo, AnyRate, AVR, AVR logo, AVR Freaks, BeaconThings, BitCloud, CryptoMemory, CryptoRF, dsPIC, FlashFlex, flexPWR, Helder, JukeBlox, KEELOQ, KEELOQ logo, Klear, LANCheck, LINK MD, maXStylus, maXTouch, MediaLB, megaAVR, MOST, MOST logo, MPLAB, OptoLyzr, PIC, picoPower, PICSTART, PIC32 logo, Prochip Designer, QTouch, RightTouch, SAM-BA, SpyNIC, SST, SST Logo, SuperFlash, tinyAVR, UNI/O, and XMEGA are registered trademarks of Microchip Technology Incorporated in the U.S.A. and other countries.

ClockWorks, The Embedded Control Solutions Company, EtherSynch, Hyper Speed Control, HyperLight Load, IntelliMOS, mTouch, Precision Edge, and Quiet-Wire are registered trademarks of Microchip Technology Incorporated in the U.S.A.

Adjacent Key Suppression, AKS, Analog-for-the-Digital Age, Any Capacitor, AnyIn, AnyOut, BodyCom, chipKIT, chipKIT logo, CodeGuard, CryptoAuthentication, CryptoCompanion, CryptoController, dsPICDEM, dsPICDEM.net, Dynamic Average Matching, DAM, ECAN, EtherGREEN, In-Circuit Serial Programming, ICSP, Inter-Chip Connectivity, JitterBlocker, KlearNet, KlearNet logo, Mindi, MiWi, motorBench, MPASM, MPF, MPLAB Certified logo, MPLIB, MPLINK, MultiTRAK, NetDetach, Omniscient Code Generation, PICDEM, PICDEM.net, PICkit, PICtail, PureSilicon, QMatrix, RightTouch logo, REAL ICE, Ripple Blocker, SAM-ICE, Serial Quad I/O, SMART-I.S., SQI, SuperSwitcher, SuperSwitcher II, Total Endurance, TSHARC, USBCheck, VariSense, ViewSpan, WiperLock, Wireless DNA, and ZENA are trademarks of Microchip Technology Incorporated in the U.S.A. and other countries.

SQTP is a service mark of Microchip Technology Incorporated in the U.S.A.

Silicon Storage Technology is a registered trademark of Microchip Technology Inc. in other countries.

GestIC is a registered trademark of Microchip Technology Germany II GmbH & Co. KG, a subsidiary of Microchip Technology Inc., in other countries.

All other trademarks mentioned herein are property of their respective companies.

© 2017, Microchip Technology Incorporated, All Rights Reserved.
ISBN: 978-1-5224-1675-3



Table of Contents

Preface	7
Introduction.....	7
Document Layout	7
Conventions Used in this Guide	8
Warranty Registration.....	8
Recommended Reading.....	9
The Microchip Web Site	9
Product Change Notification Service.....	9
Customer Support	9
Document Revision History	9
Chapter 1. Product Overview	
1.1 Introduction	10
1.2 CL88020 Device Overview	10
1.3 CL88020 Device Key Features	10
1.4 CL88020 120 V _{AC} Offline LED Driver Evaluation Board	13
1.5 Evaluation Board Kit Contents	14
Chapter 2. Installation and Operation	
2.1 Introduction	15
2.2 Getting Started	16
2.3 Setup Procedure	16
2.4 How Does the CL88020 120 V _{AC} Offline LED Driver Evaluation Board Work?	17
2.5 Board Testing	18
Appendix A. Schematic and Layouts	
A.1 Introduction	19
A.2 Board Schematic - ADM00766	20
A.3 Board Schematic - ADM00767	21
A.4 ADM00766 – Top Silk	22
A.5 ADM00766 – Top Copper And Silk.....	22
A.6 ADM00766 – Top Copper	23
A.7 ADM00766 – Bottom Copper	23
A.8 ADM00766 – Bottom Copper and Silk	24
A.9 ADM00766 – Bottom Silk	24
A.10 ADM00767 – Top Silk	25
A.11 ADM00767 – Top Copper and Silk	25

CL88020

120 V_{AC} Offline LED Driver Evaluation Board User's Guide

A.12 ADM00767 – Top Copper	26
A.13 ADM00767 – Bottom Copper	26
A.14 ADM00767 – Bottom Copper and Silk	27
A.15 ADM00767 – Bottom Silk	27
Appendix B. Bill of Materials (BOM)	29
Appendix C. Waveforms	
C.1 CL88020 120 V _{AC} Offline LED Driver Evaluation Board Typical Waveforms	31
Worldwide Sales and Service	39

Object of Declaration: CL88020 120 V_{AC} Offline LED Driver Evaluation Board

EU Declaration of Conformity

This declaration of conformity is issued by the manufacturer.

The development/evaluation tool is designed to be used for research and development in a laboratory environment. This development/evaluation tool is not a Finished Appliance, nor is it intended for incorporation into Finished Appliances that are made commercially available as single functional units to end users under EU EMC Directive 2004/108/EC and as supported by the European Commission's Guide for the EMC Directive 2004/108/EC (8th February 2010).

This development/evaluation tool complies with EU RoHS2 Directive 2011/65/EU.

This development/evaluation tool, when incorporating wireless and radio-telecom functionality, is in compliance with the essential requirement and other relevant provisions of the R&TTE Directive 1999/5/EC and the FCC rules as stated in the declaration of conformity provided in the module datasheet and the module product page available at www.microchip.com.

For information regarding the exclusive, limited warranties applicable to Microchip products, please see Microchip's standard terms and conditions of sale, which are printed on our sales documentation and available at www.microchip.com.

Signed for and on behalf of Microchip Technology Inc. at Chandler, Arizona, USA.

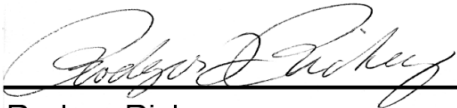

Rodger Richey
Director of Development Tools



Date

NOTES:

Preface

NOTICE TO CUSTOMERS

All documentation becomes dated, and this manual is no exception. Microchip tools and documentation are constantly evolving to meet customer needs, so some actual dialogs and/or tool descriptions may differ from those in this document. Please refer to our web site (www.microchip.com) to obtain the latest documentation available.

Documents are identified with a “DS” number. This number is located on the bottom of each page, in front of the page number. The numbering convention for the DS number is “DSXXXXA”, where “XXXX” is the document number and “A” is the revision level of the document.

For the most up-to-date information on development tools, see the MPLAB® IDE online help. Select the Help menu, and then Topics to open a list of available online help files.

INTRODUCTION

This chapter contains general information that will be useful to know before using the CL88020 120 V_{AC} Offline LED Driver Evaluation Board. Items discussed in this chapter include:

- [Document Layout](#)
- [Conventions Used in this Guide](#)
- [Recommended Reading](#)
- [The Microchip Web Site](#)
- [Product Change Notification Service](#)
- [Customer Support](#)
- [Document Revision History](#)

DOCUMENT LAYOUT

This document describes how to use the CL88020 120 V_{AC} Offline LED Driver Evaluation Board to evaluate and demonstrate the CL88020 LED driver capabilities. The manual layout is as follows:

- **Chapter 1. “Product Overview”** – Important information about the CL88020 120 V_{AC} Offline LED Driver Evaluation Board.
- **Chapter 2. “CL88020 120 V_{AC} Offline LED Driver Evaluation Board Installation and Operation”** – This chapter includes a detailed description of each function of the demonstration board and instructions on how to use the board.
- **Appendix A. “Schematic and Layouts”** – Shows the schematic and layout diagrams for the CL88020 120 V_{AC} Offline LED Driver Evaluation Board.
- **Appendix B. “Bill of Materials (BOM)”** – Lists the parts used to build the CL88020 120 V_{AC} Offline LED Driver Evaluation Board.
- **Appendix C. “CL88020 120 V_{AC} Offline LED Driver Evaluation Board User’s Guide**CL88020 120 V_{AC} Offline LED Driver Evaluation Board User’s

CL88020 120 V_{AC} Offline LED Driver Evaluation Board User's Guide

GuideWaveforms – Describes the waveforms for the CL88020 120 V_{AC} Offline LED Driver Evaluation Board.

CONVENTIONS USED IN THIS GUIDE

This manual uses the following documentation conventions:

DOCUMENTATION CONVENTIONS

Description	Represents	Examples
Arial font:		
Italic characters	Referenced books	<i>MPLAB[®] IDE User's Guide</i>
	Emphasized text	...is the <i>only</i> compiler...
Initial caps	A window	the Output window
	A dialog	the Settings dialog
	A menu selection	select Enable Programmer
Quotes	A field name in a window or dialog	"Save project before build"
Underlined, italic text with right angle bracket	A menu path	<u><i>File>Save</i></u>
Bold characters	A dialog button	Click OK
	A tab	Click the Power tab
N'Rnnnn	A number in verilog format, where N is the total number of digits, R is the radix and n is a digit.	4'b0010, 2'hF1
Text in angle brackets < >	A key on the keyboard	Press <Enter>, <F1>
Courier New font:		
Plain Courier New	Sample source code	#define START
	Filenames	autoexec.bat
	File paths	c:\mcc18\h
	Keywords	_asm, _endasm, static
	Command-line options	-Opa+, -Opa-
	Bit values	0, 1
	Constants	0xFF, 'A'
Italic Courier New	A variable argument	<i>file.o</i> , where <i>file</i> can be any valid filename
Square brackets []	Optional arguments	mcc18 [options] <i>file</i> [options]
Curly brackets and pipe character: { }	Choice of mutually exclusive arguments; an OR selection	errorlevel {0 1}
Ellipses...	Replaces repeated text	var_name [, var_name...]
	Represents code supplied by user	void main (void) { ... }

RECOMMENDED READING

This user's guide describes how to use the CL88020 120 V_{AC} Offline LED Driver Evaluation Board. Other useful documents are listed below. The following Microchip documents are available and recommended as supplemental reference resources.

- **CL88020 Data Sheet – “Sequential Linear LED Driver with 4 Taps”**
(DS20005753)

THE MICROCHIP WEB SITE

Microchip provides online support via our web site at www.microchip.com. This web site is used as a means to make files and information easily available to customers. Accessible by using your favorite Internet browser, the web site contains the following information:

- **Product Support** – Data sheets and errata, application notes and sample programs, design resources, user's guides and hardware support documents, latest software releases and archived software
- **General Technical Support** – Frequently Asked Questions (FAQs), technical support requests, online discussion groups, Microchip consultant program member listing
- **Business of Microchip** – Product selector and ordering guides, latest Microchip press releases, listing of seminars and events, listings of Microchip sales offices, distributors and factory representatives

PRODUCT CHANGE NOTIFICATION SERVICE

Microchip's customer notification service helps keep customers current on Microchip products. Subscribers will receive e-mail notifications whenever there are changes, updates, revisions or errata related to a specified product family or development tool of interest.

To register, access the Microchip web site at www.microchip.com, click on **Product Change Notification** and follow the registration instructions.

CUSTOMER SUPPORT

Users of Microchip products can receive assistance through several channels:

- Distributor or Representative
- Local Sales Office
- Field Application Engineer (FAE)
- Technical Support

Customers should contact their distributor, representative or field application engineer (FAE) for support. Local sales offices are also available to help customers. A listing of sales offices and locations is included in the back of this document.

Technical support is available through the web site at:
<http://www.microchip.com/support>

DOCUMENT REVISION HISTORY

Revision A (May 2017)

- Initial Release of this Document.

Chapter 1. Product Overview

1.1 INTRODUCTION

This chapter provides an overview of the CL88020 120 V_{AC} Offline LED Driver Evaluation Board and covers the following topics:

- CL88020 Device Overview
- CL88020 Device Key Features
- CL88020 120 V_{AC} Offline LED Driver Evaluation Board
- Evaluation Board Kit Contents

1.2 CL88020 DEVICE OVERVIEW

The CL88020 LED driver integrated circuit (IC) is targeted at general LED lighting products, such as A19 bulb with a maximum power rating of about 8.5W at 120 V_{AC} (60W incandescent equivalent bulbs).

1.3 CL88020 DEVICE KEY FEATURES

- Monolithic
 - No external FETs, minimum driver component count
- No inductors
 - Reduces BOM cost and circuit complexity
- Efficient operation
 - Typical electrical efficiencies of 80% to 83% across the AC input voltage range.
- No high frequencies
 - Inherently low conducted EMI, no need for input filters
- Inherently dimmer compatible
 - Works with most leading-edge and trailing-edge phase-cut dimmers
 - TRIAC dimmer compatible
- 120 V_{AC} only
 - Reduces die size by optimizing output FET voltages and sizes
- Targeted for 8.5W output
 - 60W incandescent equivalent (most popular), assuming minimum 94 Lm/W efficacy
- 4 taps
 - Fewer pins reduces footprint size

-
-
- Reduced light output ripple (optional)
 - An external capacitor with four diodes provides lower light output ripple
 - Use of a ceramic capacitor instead of an electrolytic means lamp life can match the LED lifetime (more than 40,000 hours versus 5,000 hours)
 - Provides continuous power to the driver
 - Active line regulation
 - Active circuitry provides better regulated output power over variations in AC line voltage
 - Between 0% to –12% line regulation typical
 - Prevents driver from overheating at high AC line voltages
 - Prevents excessive currents at low line
 - Provides reasonable line regulation and efficient operation with only 4 taps
 - Over temperature protection
 - Optional
 - An inexpensive external NTC thermistor provides remote temperature sensing. The thermistor may be located in close proximity to the LEDs to provide nearly direct monitoring of LED temperature.
 - OTP is linear (no on/off cycling)
 - A widely available, 470 k Ω NTC provides 85°C maximum temperature
 - Temperature adjustable via selection of NTC thermistor resistance
 - Two current-setting resistors
 - Different hold-up and direct AC currents lowers THD and output ripple
 - Tap current ratios internally set
 - Reduces component count
 - Fewer pins
 - Simplifies application design
 - Single-point current control for reduced EMI
 - 8-pin power SOIC
 - Higher HV creepage distances
 - Pinout arranged to minimize pin-to-pin voltage differentials
 - Pinout accommodates single-layer PCB
 - Available in a thermally-enhanced 8-Lead SOIC package with heat slug

Figure 1-1 presents the typical CL88020 offline LED driver application circuit.

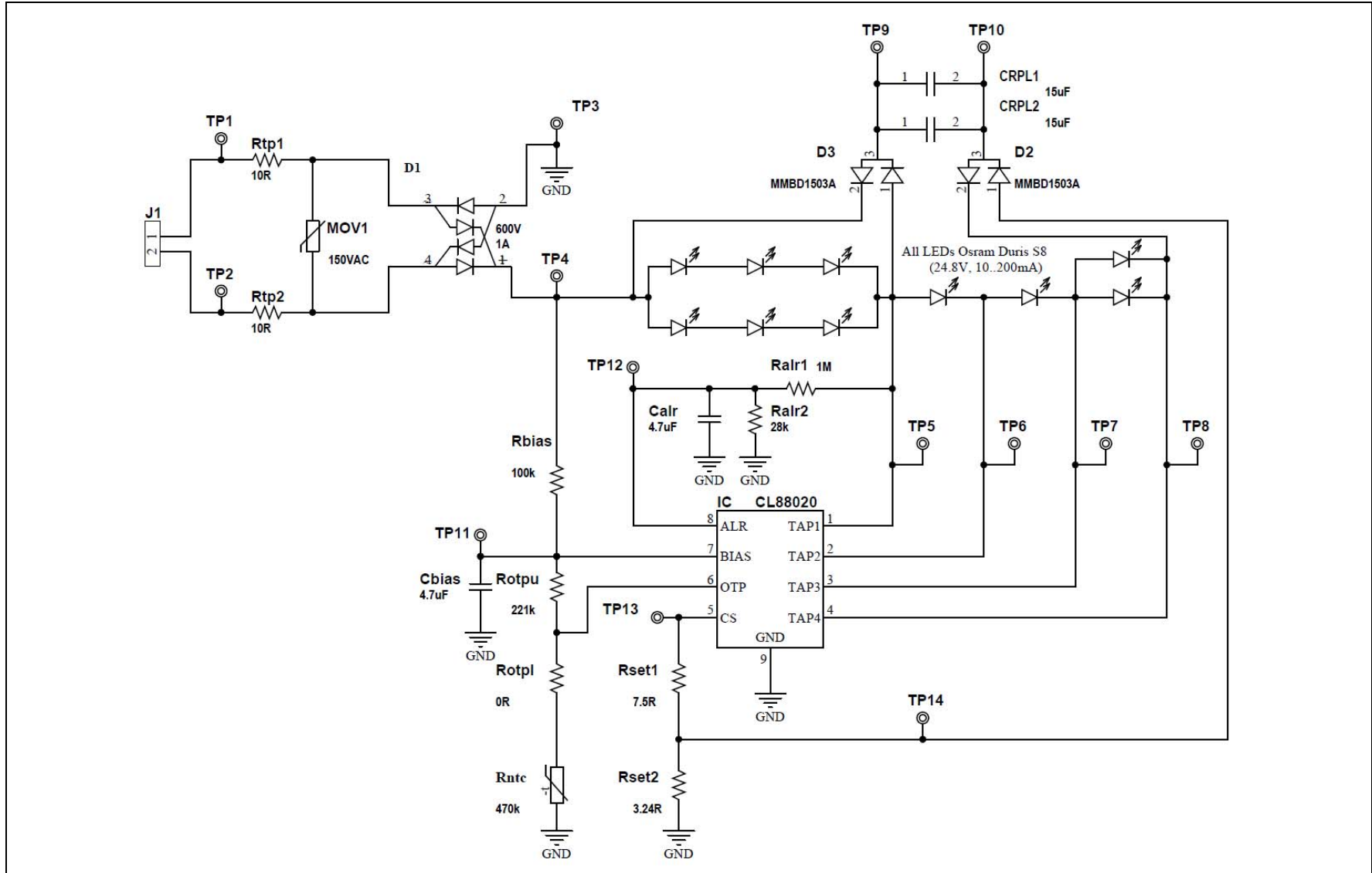

FIGURE 1-1: Typical CL88020 120 V_{AC} Offline LED Driver Evaluation Board Circuit.

1.4 CL88020 120 V_{AC} OFFLINE LED DRIVER EVALUATION BOARD

The CL88020 120 V_{AC} Offline LED Driver Evaluation Board is a complete solution consisting of an LED Driver (ADM00766) and an LED Load Board (ADM00767) powered directly from the 120V_{AC} line and based on Microchip Technology's CL88020 sequential linear LED driver. The application achieves efficient operation without using any magnetics or conventional switching techniques and is a flexible solution that allows users to design and to test their own LED Load solution. The included LED Load is made with 10 LEDs. Since no high frequencies are present, it exhibits inherently low conducted and radiated EMI without needing input filters or shielding. Because the current through the LEDs follows the AC input voltage, PFC circuitry is also not needed. The CL88020 is inherently compatible with both leading-edge and trailing-edge dimmers, with no need for special circuitry to detect and respond to them.

The LED Load is provided on a double-layer 60 mm diameter FR4 PCB (0.6 mm thick) mounted on a pin-fin heat sink. The LED Driver PCB (ADM00766) is made on 1.6 mm standard double-layer FR4. The kit includes an 8-wire flat cable to connect the LED Driver Board to the LED Load, and a black anodized pin fin heat sink with double-sided adhesive thermal tape necessary to mount the LED Load Board on it. All circuitry and hardware is provided, along with transient protection and overtemperature protection. Just plug into a 120 V_{AC} outlet (50 Hz or 60 Hz) to get started.

Figure 1-2 presents the CL88020 LED Driver Evaluation Board.

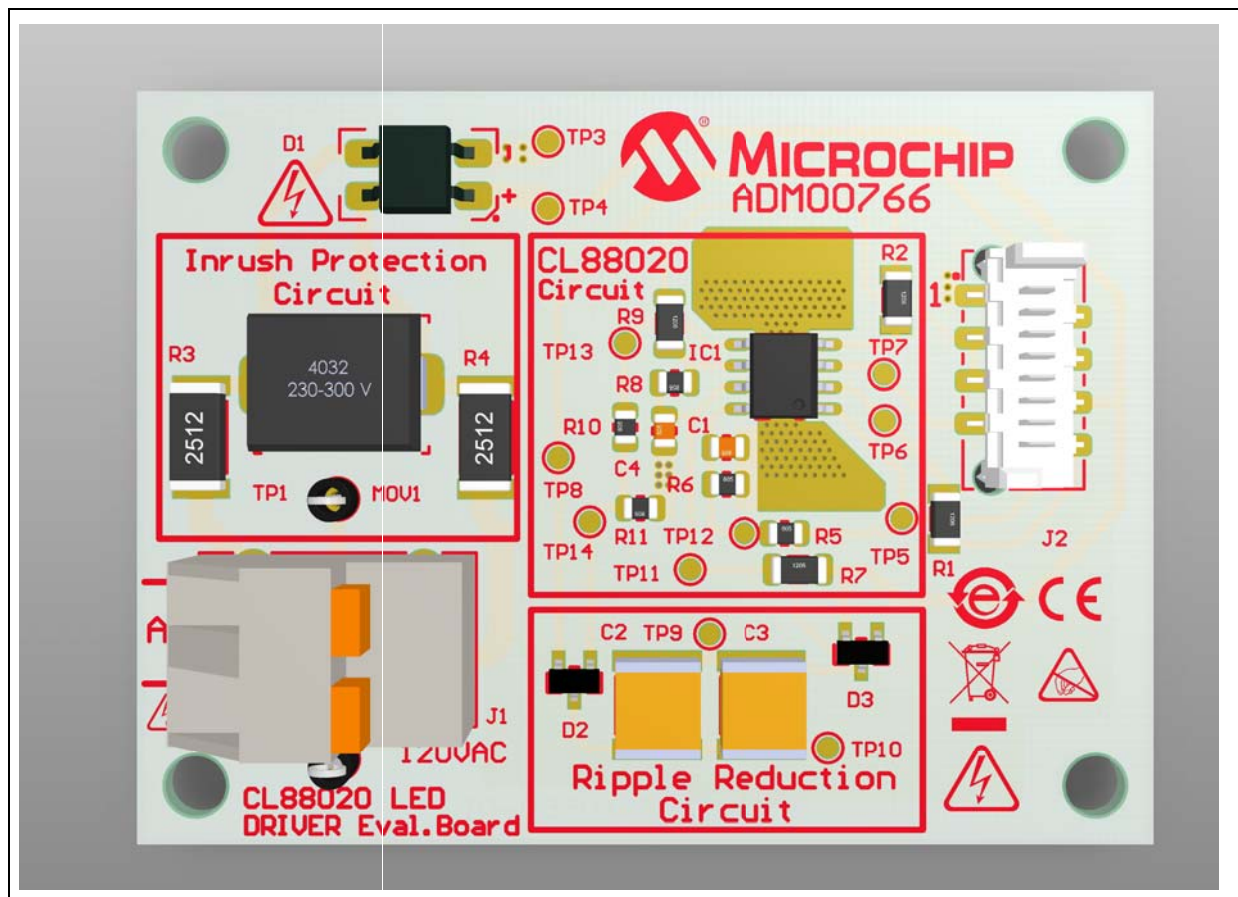

FIGURE 1-2: CL88020 LED Driver Evaluation Board Source Board (ADM00766) - Top View.

Figure 1-3 presents the CL88020 LED Load Board.

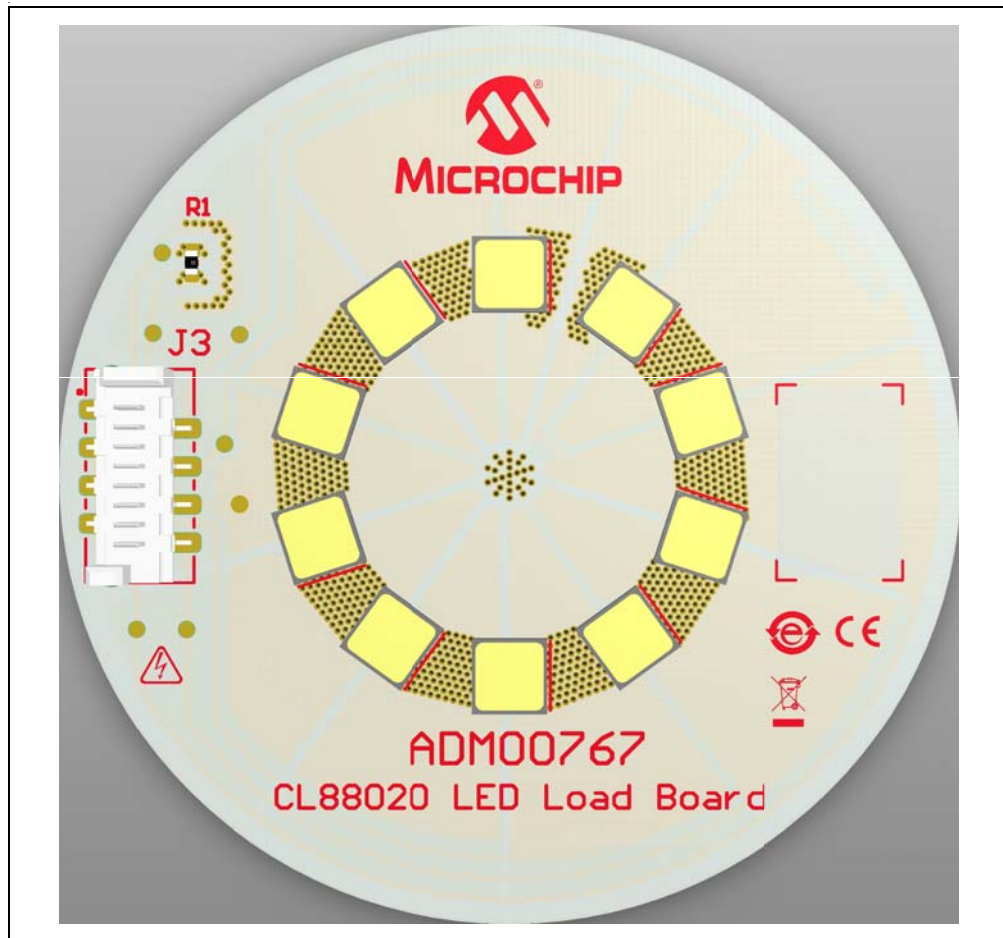

FIGURE 1-3: CL88020 LED Load Board (ADM00767) - Top View.

1.5 EVALUATION BOARD KIT CONTENTS

The CL88020 120 V_{AC} Offline LED Driver Evaluation Board Kit includes:

- CL88020 LED Driver Evaluation Board (ADM00766)
- 8-wire interconnection flat cable
- 4 nylon stand-offs with corresponding screw
- Important Information Sheet

The CL88020 LED Load Board (ADM00767) is available for purchase from www.microchipdirect.com. The CL88020 LED Load Board (ADM00767) kit includes:

- CL88020 LED Load Board (ADM00767)
- LED Load pin fin heat sink
- Thermal double-sided adhesive tape
- Important Information Sheet

Note: Since the power of the application is about 10W for longer operation of the LED Load (more than 30 sec), attach the provided heat sink using the double adhesive thermal tape by following these steps:

1. Be sure that before you start, the surface of the heatsink and of the PCB to be dry and clean (use a cotton made smooth material to clean if needed).
2. Detach the protection foil on the thermal tape from one side
3. Attach the open portion of the thermal tape on the base of the heatsink
4. Detach the second protection foil from the thermal tape
5. Attach the PCB (ADM00767) to the heat sink.
6. Slowly press on the top of the PCB to be sure that the thermal contact will be made all-over the board

Chapter 2. CL88020 120 V_{AC} Offline LED Driver

Evaluation Board Installation and Operation

2.1 INTRODUCTION

CL88020 120 V_{AC} Offline LED Driver Evaluation Board User's Guide is intended to drive a long string of low-current LEDs directly from the AC mains. A basic driver circuit consists of CL88020, six resistors and a bridge rectifier. Two to four additional components are optional for various levels of transient protection, also with a low-price NTC to assure remote overtemperature protection (OTP). No capacitors, EMI filters or power factor correction circuits are needed.

A string of series/parallel LEDs is tapped at four locations. Four linear current regulators sink current at each tap through a single control point and are sequentially turned on and off. High efficiency is achieved by shutting off upstream regulators when downstream regulators achieve regulation. This makes controlling overall input current easier than trying to control multiple current paths, thereby tracking the input sine wave voltage. Voltage across each regulator is minimized when conducting, providing high efficiency. It implements a self-commutation technique using only the tap currents; this technique inherently provides smooth transitions from one regulator to the next, without relying on tap voltages or the rectified AC to coordinate the transitions. The current waveform can be tailored to optimize for input voltage range, active line/load regulation, output power/current, efficiency, power factor, THD, dimmer compatibility and LED utilization. With the addition of an RC network, the driver is compatible with a wider range of phase-cut dimmers. The data sheet includes a description of how the driver operates, with design guidelines and examples.

2.1.1 CL88020 LED Driver Evaluation Board Features

The CL88020 LED Driver Evaluation Board (ADM00766) has the following features:

- Input Voltage: 120 V_{rms} +/-15%, 50/60 Hz
- Typical Output Capability: up to 130 mA
- Efficiency: Over 83%
- Max Output Power: 8.5W (depends on the cooling provided)

The CL88020 LED Load Board (ADM00767), has the following features:

- Contains 10 LEDs (GW P9LR31.EM) grouped in 4 taps
- An 8-wire flat cable input connector
- One NTC for overtemperature protection

2.2 GETTING STARTED

The CL88020 120 V_{AC} Offline LED Driver Evaluation Board is fully tested to evaluate and demonstrate the CL88020 LED Driver.

WARNING

The CL88020 LED Driver Evaluation Board (ADM00766) and CL88020 LED Load Board (ADM00767) do NOT provide electrical isolation between the AC line and the lamp circuitry. Dangerous voltages are present when connected to the AC line. Exercise caution!

Take into account the following recommendations before starting the setup process:

- Place the CL88020 LED Driver Evaluation Board and the LED Load assembly on a non-conductive surface when connected to the AC line.
- Do not come into contact with any of the two demonstration unit boards while they are connected to the AC line.
- Disconnect the demo units from the mains before performing any work on any of them.
- Do not connect instruments having earth-referenced inputs, such as most oscilloscopes.
- It is suggested that utility power for testing be provide from an AC source with a floating output, and that differential voltage probes are used.

2.3 SETUP PROCEDURE

Powering the CL88020 120 V_{AC} Offline LED Driver Evaluation Board is easy; the only connections to be made are from ADM00766 LED driver to the LED Load ADM00767 assembled on a pin-fin heat sink, using the 8-wire flat cable provided, and from the LED Driver Board to the AC line through a power cord.

Follow these steps:

1. Read the above recommendations and precautions.
2. Connect the CL88020 LED Driver Evaluation Board and the CL88020 LED Load Board by means of the provided 8-wire flat cable, between J2-J3 connectors. It is recommended to exercise caution, as the connectors on the flat cable are protected from being connected incorrectly.
3. Connect power cord on J1 on the LED Driver board, ADM00766. The Input connector J1 is placed on the left side of the LED Driver board, which is marked with the inscription: AC.
4. Plug the power cord into a 120 V_{AC} outlet and apply 120 V_{AC} ±15%, 60 Hz. While it is possible for the values to be below this range, it is recommended not to exceed 144 V_{AC}. In this case the Transient Protection feature is automatically activated. Line frequency is not critical (50 Hz or 60 Hz).

A variable AC power supply is needed for testing and evaluation in the laboratory. The power supply requires an output capability of at least 20W and a voltage range from 0 to 150 V_{AC}. This can be obtained also from an autotransformer supplied from the mains or an electronic AC/AC power supply (for example, the Chroma ATE Inc. 61500 series).

Note: Auto-transformers do not provide isolation from the utility mains.

Figure 2-1 illustrates the connection between ADM00766 and ADM00767.

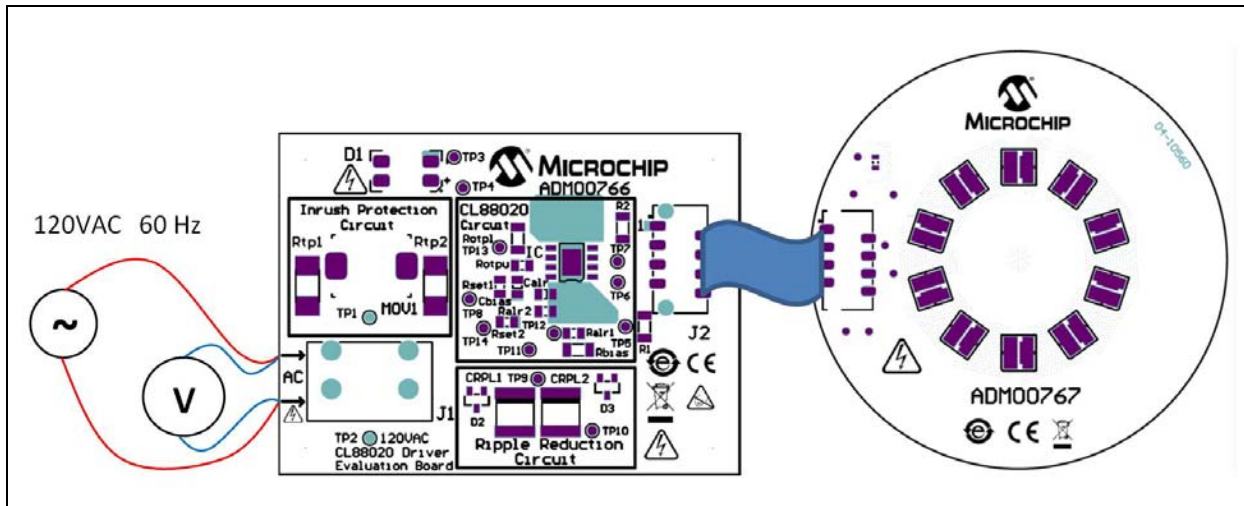

FIGURE 2-1: Connection Diagram.

2.4 HOW DOES THE CL88020 120 V_{AC} OFFLINE LED DRIVER EVALUATION BOARD WORK?

The CL88020 120 V_{AC} Offline LED Driver Evaluation Board is designed to control the current through the four LED taps while maintaining high-input power factor (PF) and low total harmonic distortion (THD). The CL88020 120 V_{AC} Offline LED Driver Evaluation Board includes a CL88020 IC, which is a sequential linear LED driver controlling four taps. Tap sequencing assures the regulators are turned on and off at the proper times. Tap sequencing also controls the smooth transition from one regulator to the next without generating EMI-causing glitches in input current. Two concepts are involved:

- The first is single-point control. All tap currents pass through a single control point. This makes controlling overall input current easier than trying to control multiple current paths.
- The second concept is called self-commutation. Using only the tap currents themselves, this technique inherently provides smooth transitions from one regulator to the next without relying on tap voltages or the rectified AC to coordinate the transitions. This avoids having to monitor high voltages and is more precise.

These two concepts work together to properly sequence the current regulators and to provide glitch-free operation and thus avoiding conducted EMI.

The CL88020 120 V_{AC} Offline LED Driver Evaluation Board and the CL88020 LED Load Board contain all the circuitry necessary to perform, as well as overtemperature protection (OTP), active line regulation (ALR) and output light ripple reduction.

The OTP protection operates linearly, gradually reducing output power as temperature increases. This uses an inexpensive, external NTC thermistor to remotely sense LED temperature. The thermistor is located on the LED load board, ADM00767, in close proximity to the LEDs, providing near-direct LED temperature monitoring. The OTP temperature is adjustable via selection of NTC resistance.

The ALR circuit maintains fairly constant output power over variations in AC line voltage. It is not a closed loop system that directly monitors and corrects output power. Instead, it monitors the average voltage applied to the LED string and uses it to adjust the reference voltage provided to the tap current regulators.

The Ripple Reduction Circuit (RRC), providing low output ripple, consists of a capacitor and four diodes. The capacitor may be one or more paralleled capacitors, preferably ceramic types to preserve long life expectancy for the LED application. The CL88020 with RRC operates in four phases: recharge, hold-up, direct and, under certain conditions, idle. All active current paths includes Segment 1 (TAP1), assuring uninterrupted light output on it during all phases of operation, excluding idle. That is why it is important to have a much greater number of LEDs on TAP 1 compared to the rest of the taps, in this case six. This reduces overall ripple, which provides about 0.15 flicker index.

For more information, see the CL88020 data sheet.

2.5 BOARD TESTING

To start testing the evaluation board, follow these steps:

1. Connect the input AC source and the output LED Load as shown in [Figure 2-1](#).
2. Use an eye protection filter to check that all the 4 taps light up on the CL88020 LED Driver Evaluation Board.
3. Power the board at 120 V_{AC}.
4. Verify each tap current through the LEDs. It should be within 65 mA to 134 mA. It can be measured by separating each wire from the inter-connection 8-wire flat cable between the CL88020 LED Driver Evaluation Board (ADM00766) and CL88020 LED Load Board (ADM00767).
5. If a variable AC source is available, set the input voltage to any value between 100 V_{AC} and 135 V_{AC}. The LED Load delivers nearly constant lumen power.
6. Power-down the AC source.

Appendix A. Schematic and Layouts

A.1 INTRODUCTION

This appendix contains the following schematics and layouts for the CL88020 120 V_{AC} Offline LED Driver Evaluation Board and for the CL88020 LED Load Board:

- Board Schematic - ADM00766
- Board Schematic - ADM00767
- CL88020 LED Driver Evaluation Board
 - ADM00766 – Top Silk
 - ADM00766 – Top Copper And Silk
 - ADM00766 – Top Copper
 - ADM00766 – Bottom Copper
 - ADM00766 – Bottom Copper and Silk
 - ADM00766 – Bottom Silk
- CL88020 LED Load Board
 - ADM00767 – Top Silk
 - ADM00767 – Top Copper and Silk
 - ADM00767 – Top Copper
 - ADM00767 – Bottom Copper
 - ADM00767 – Bottom Copper and Silk
 - ADM00767 – Bottom Silk

A.2 BOARD SCHEMATIC - ADM00766

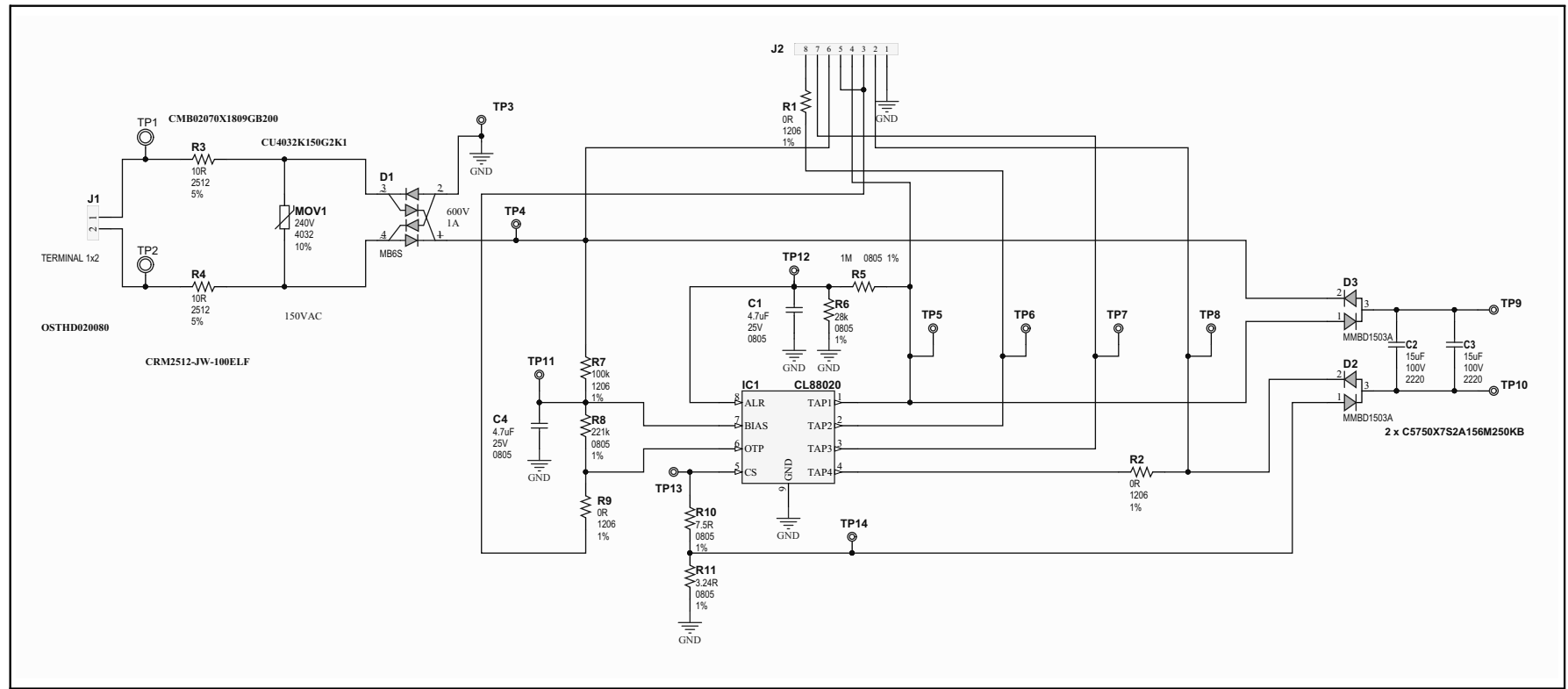

A.3 BOARD SCHEMATIC - ADM00767

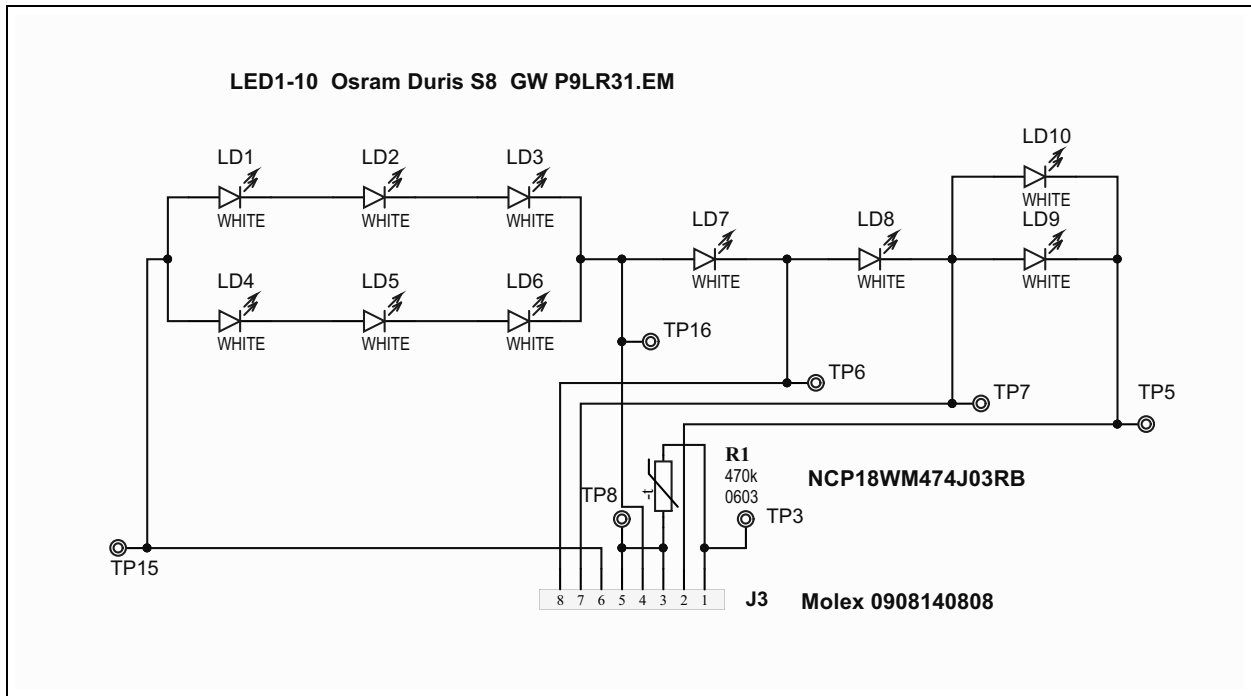

A.4 ADM00766 – TOP SILK

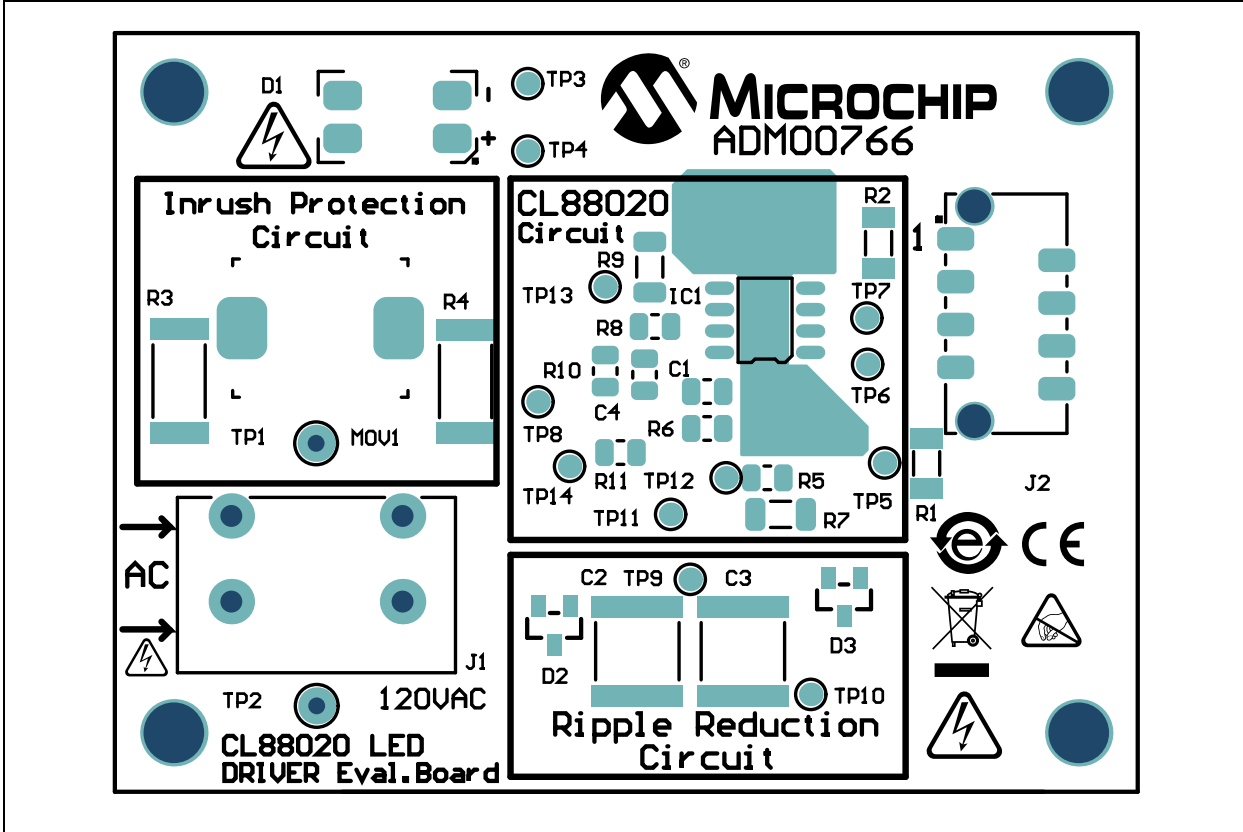

A.5 ADM00766 – TOP COPPER AND SILK

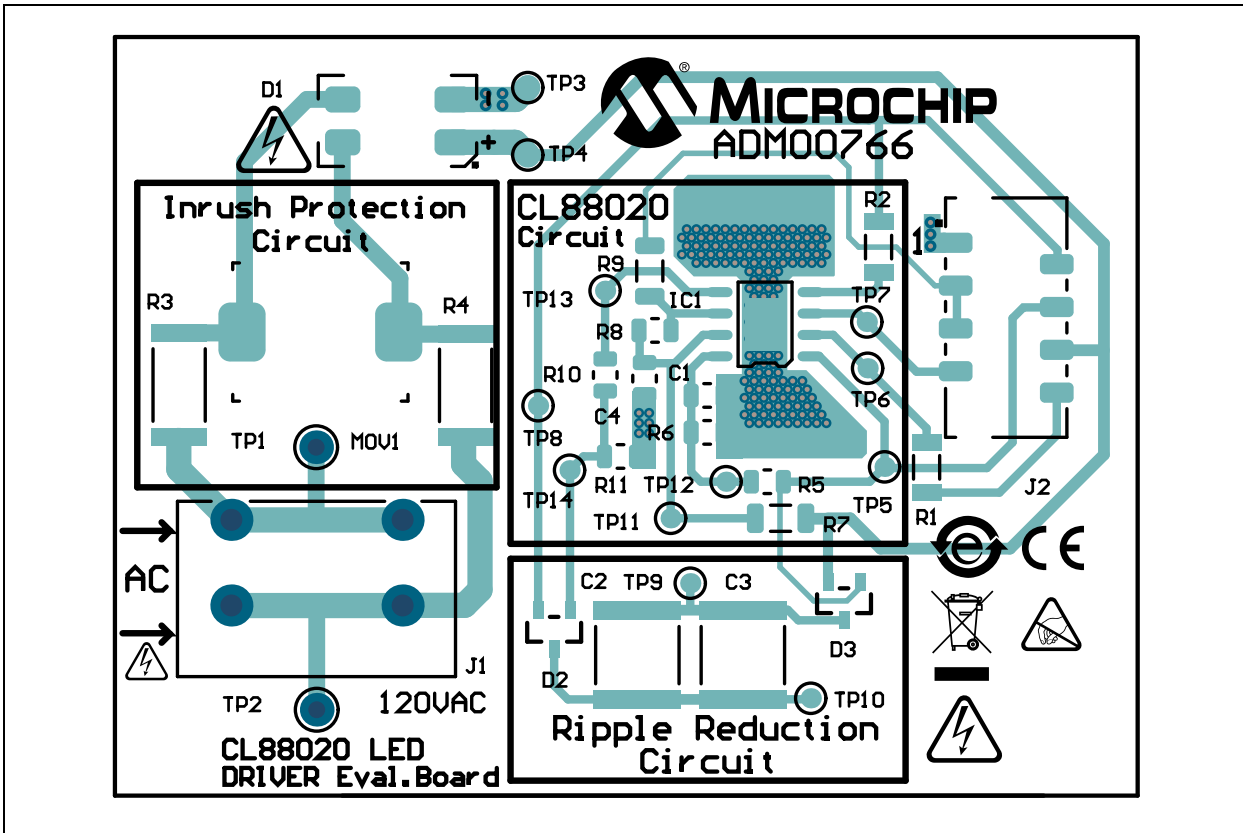

A.6 ADM00766 – TOP COPPER

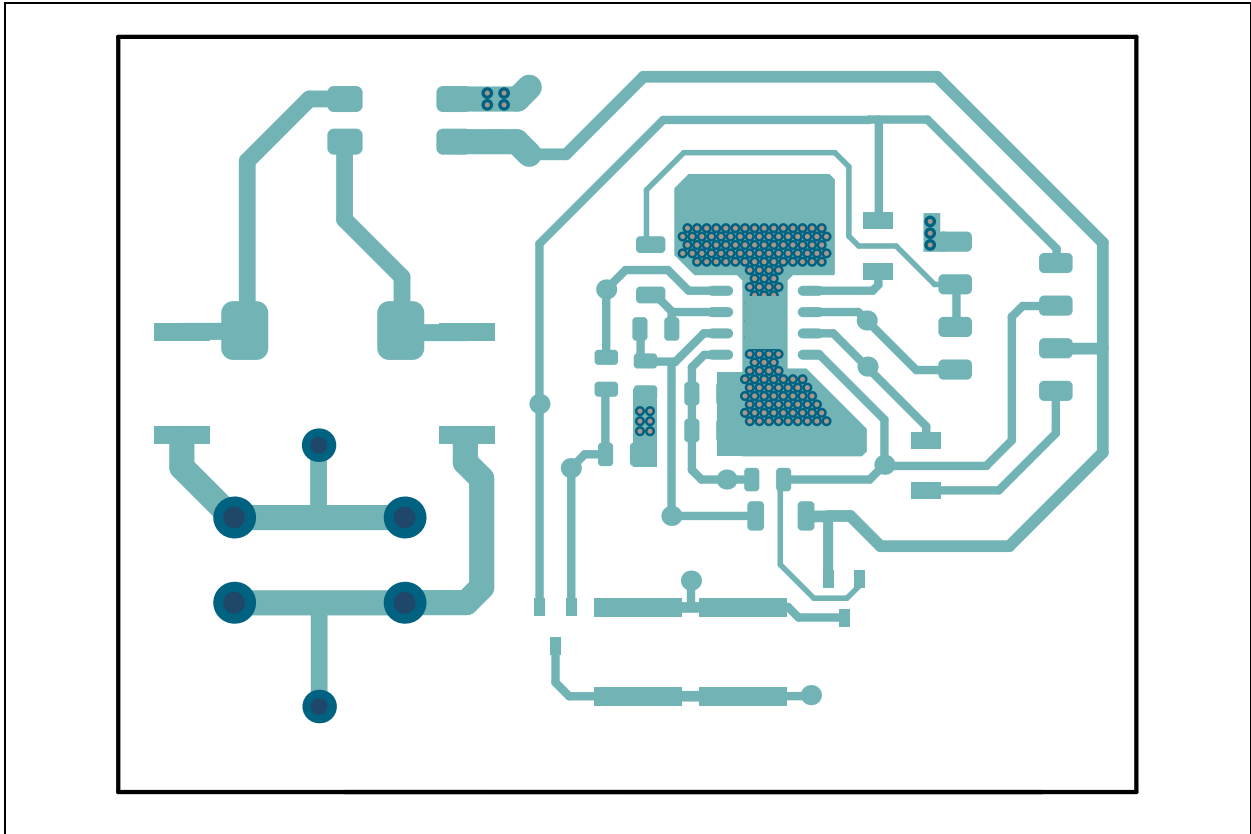

A.7 ADM00766 – BOTTOM COPPER

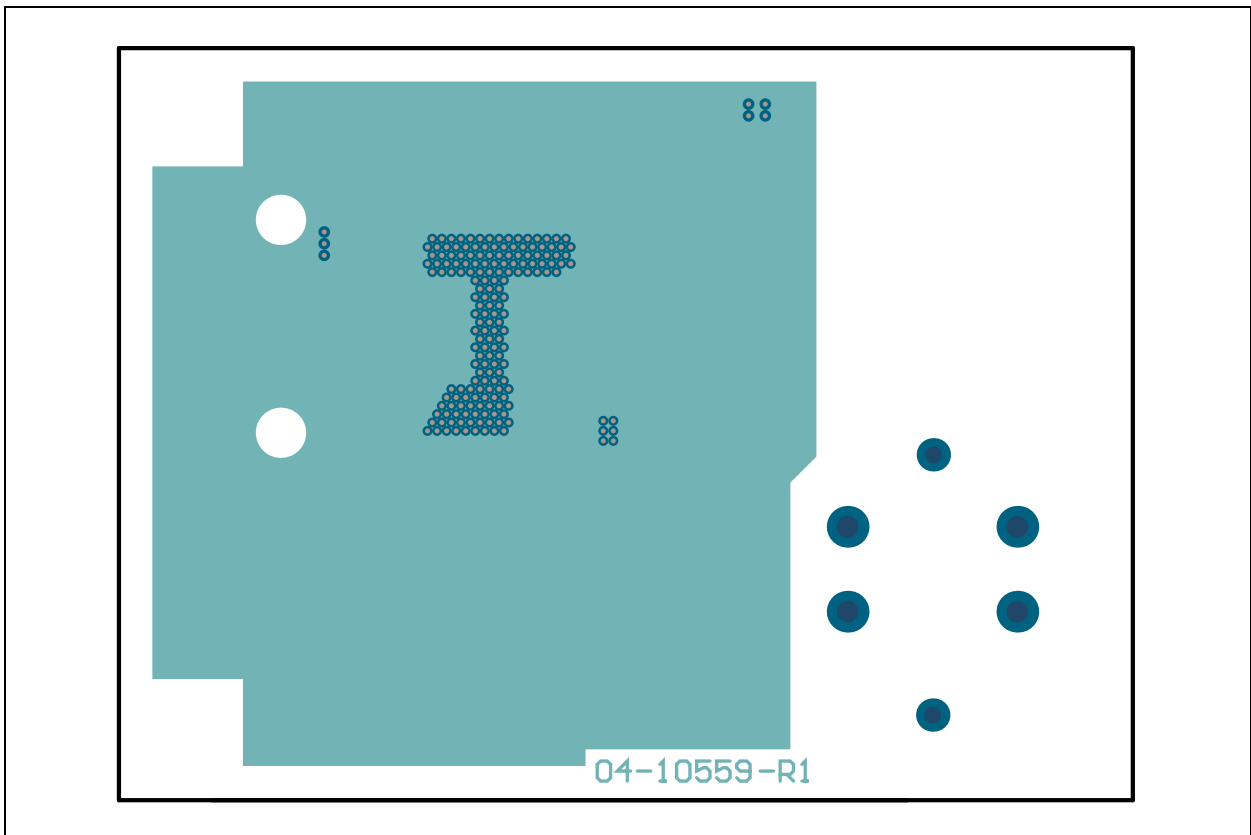

A.8 ADM00766 – BOTTOM COPPER AND SILK

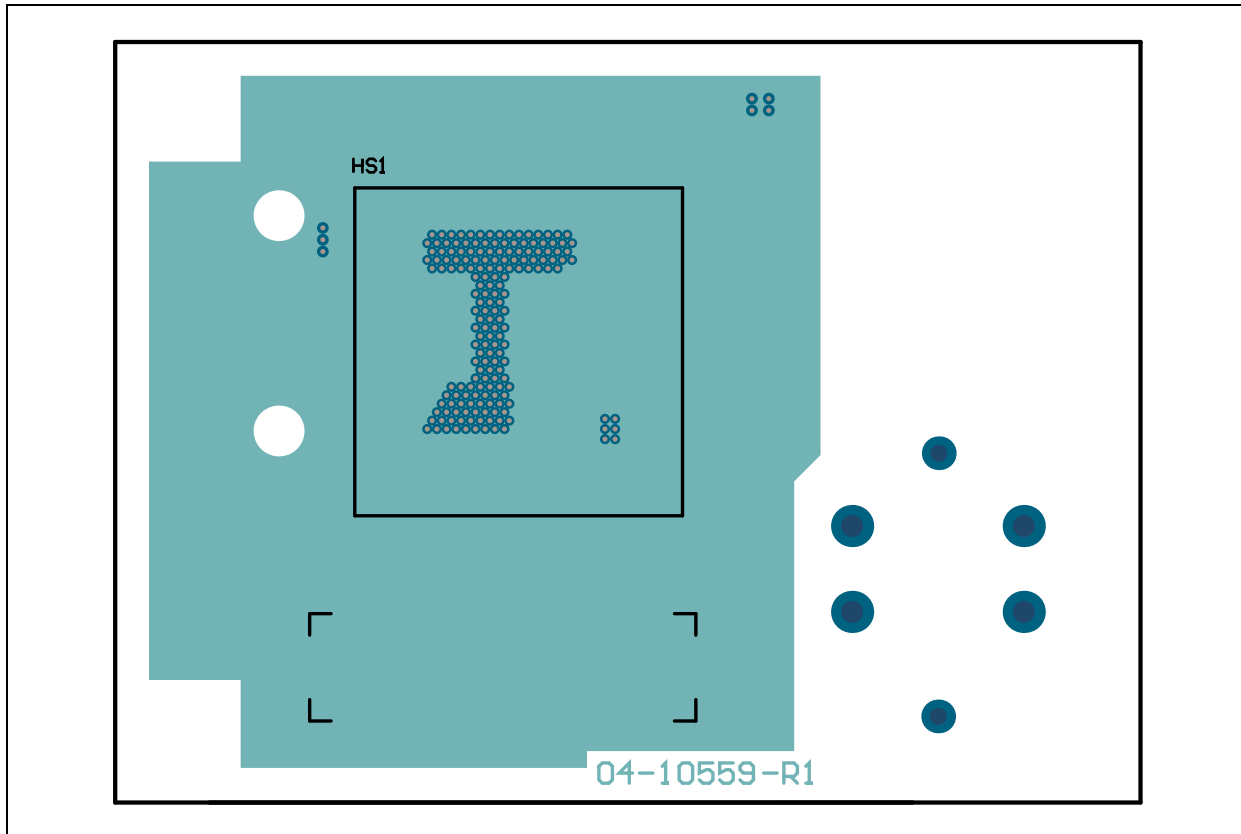

A.9 ADM00766 – BOTTOM SILK

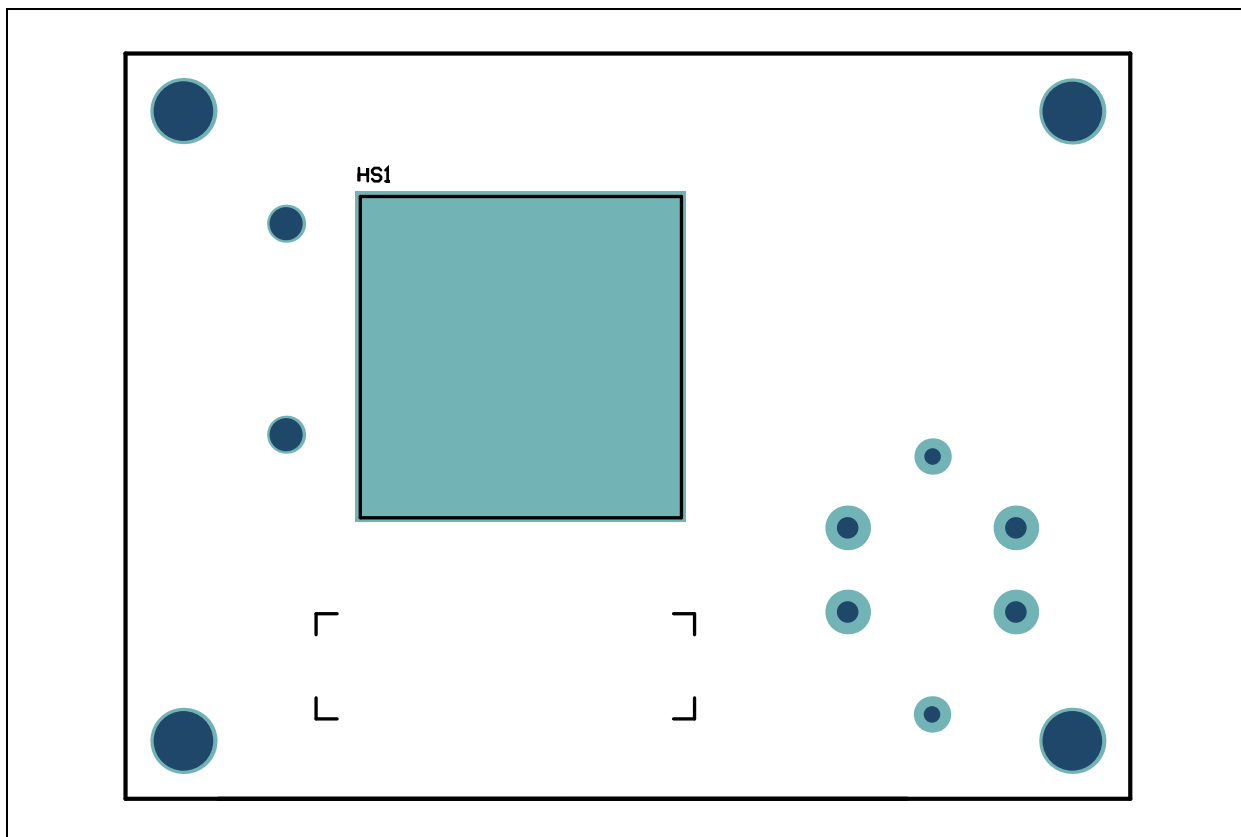

A.10 ADM00767 – TOP SILK

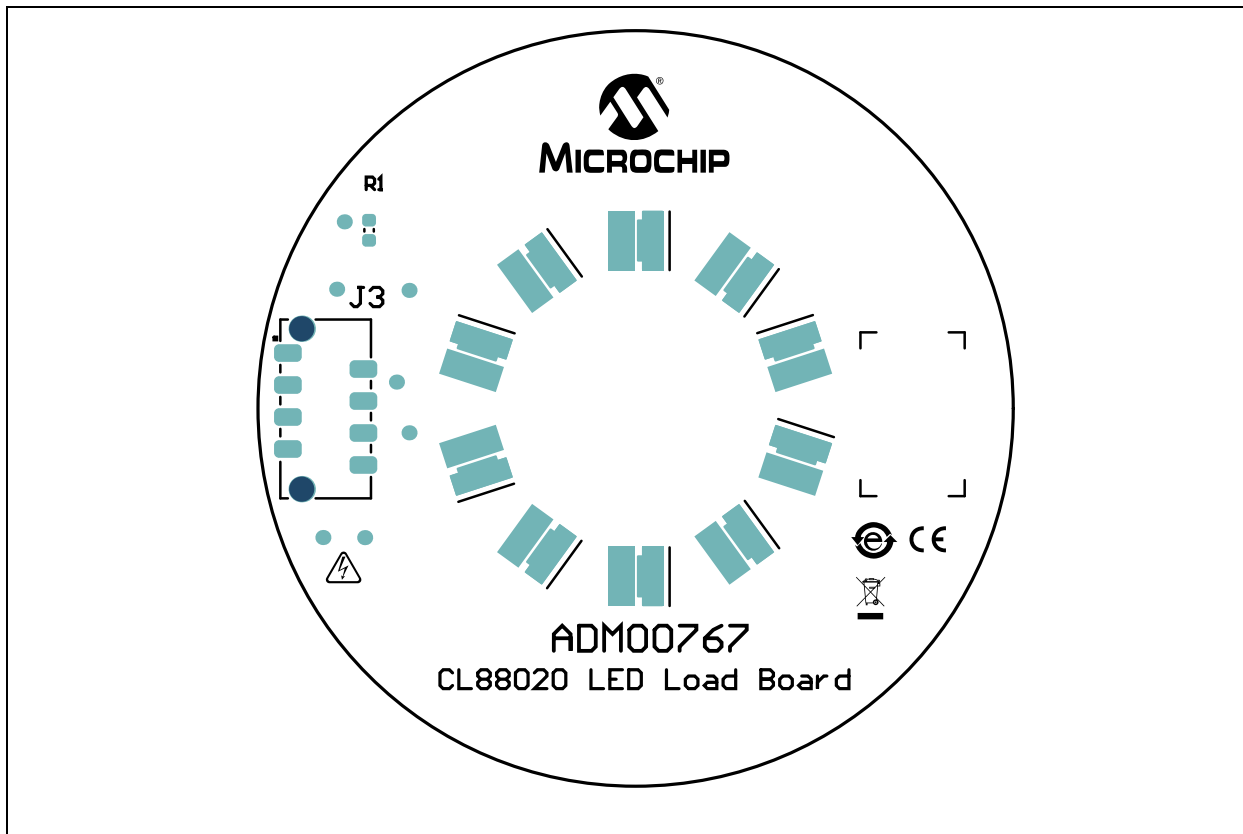

A.11 ADM00767 – TOP COPPER AND SILK

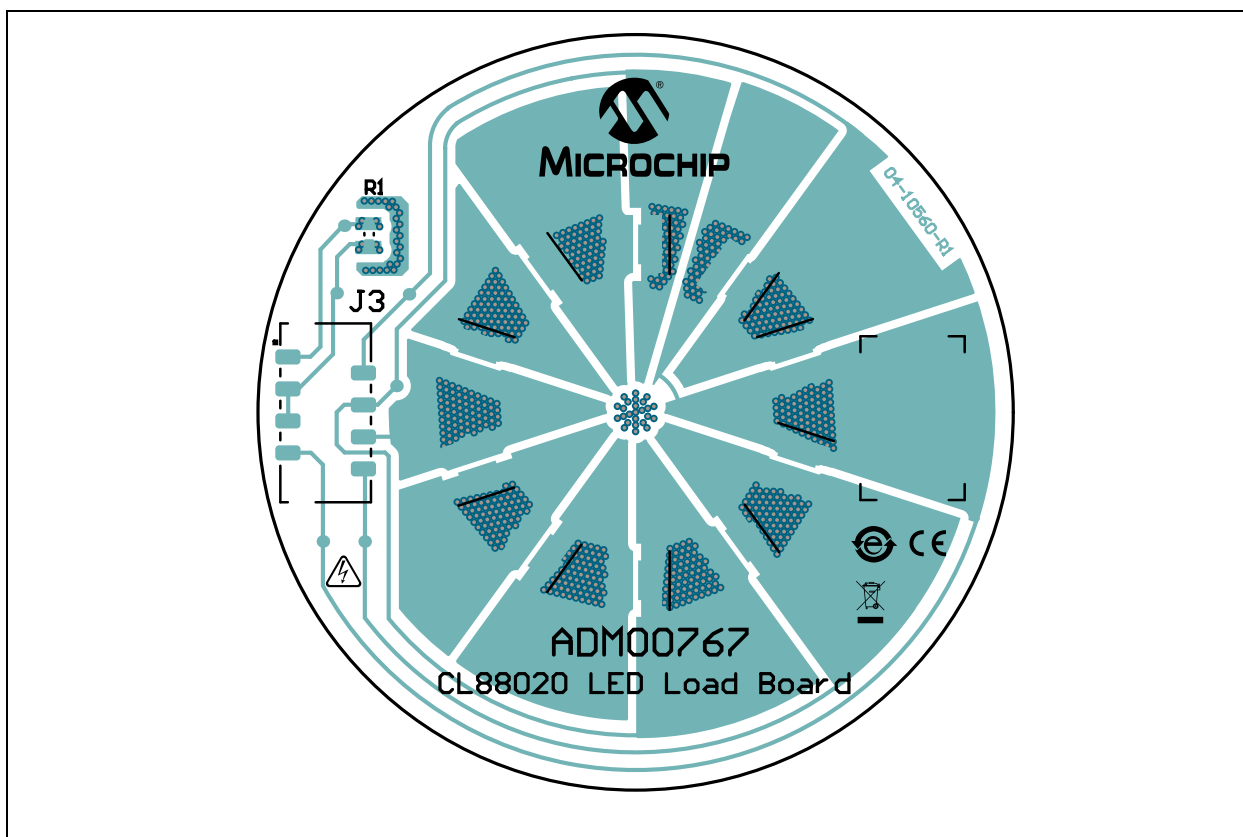

A.12 ADM00767 – TOP COPPER

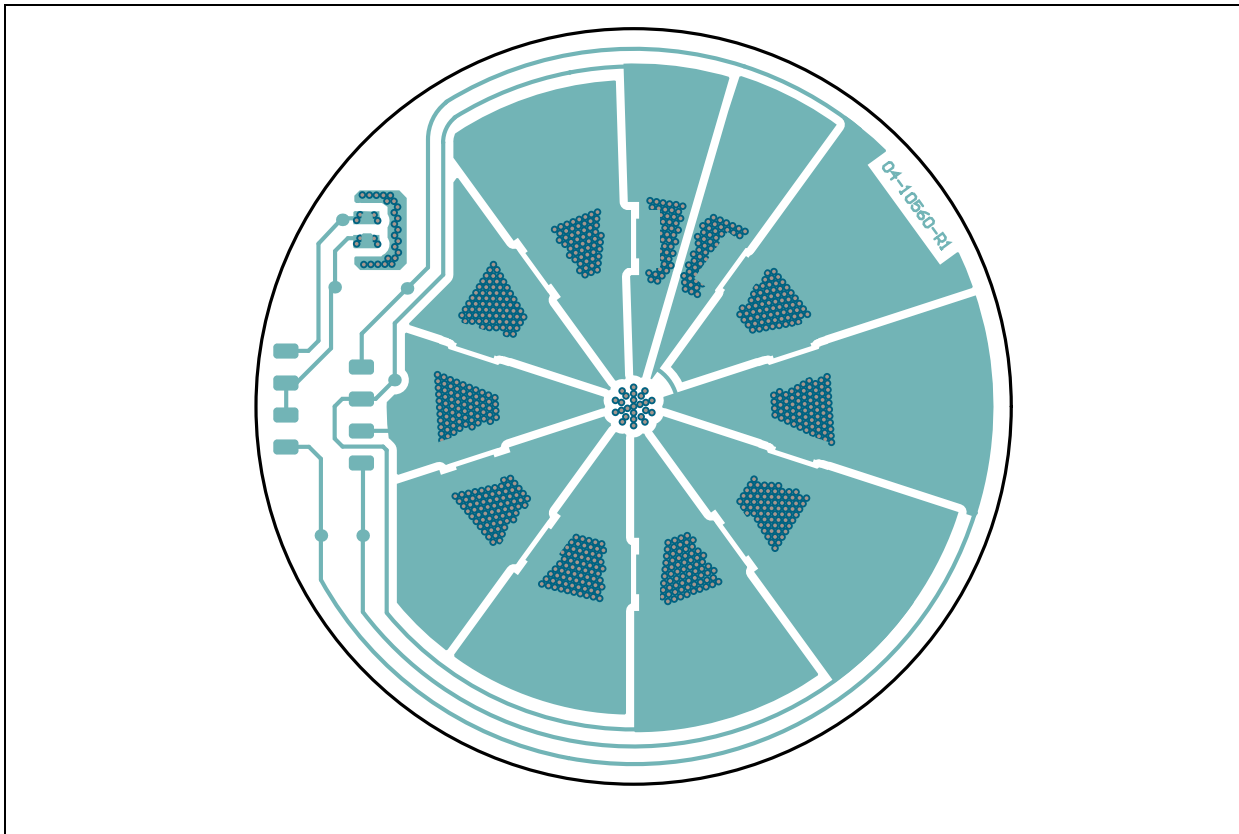

A.13 ADM00767 – BOTTOM COPPER

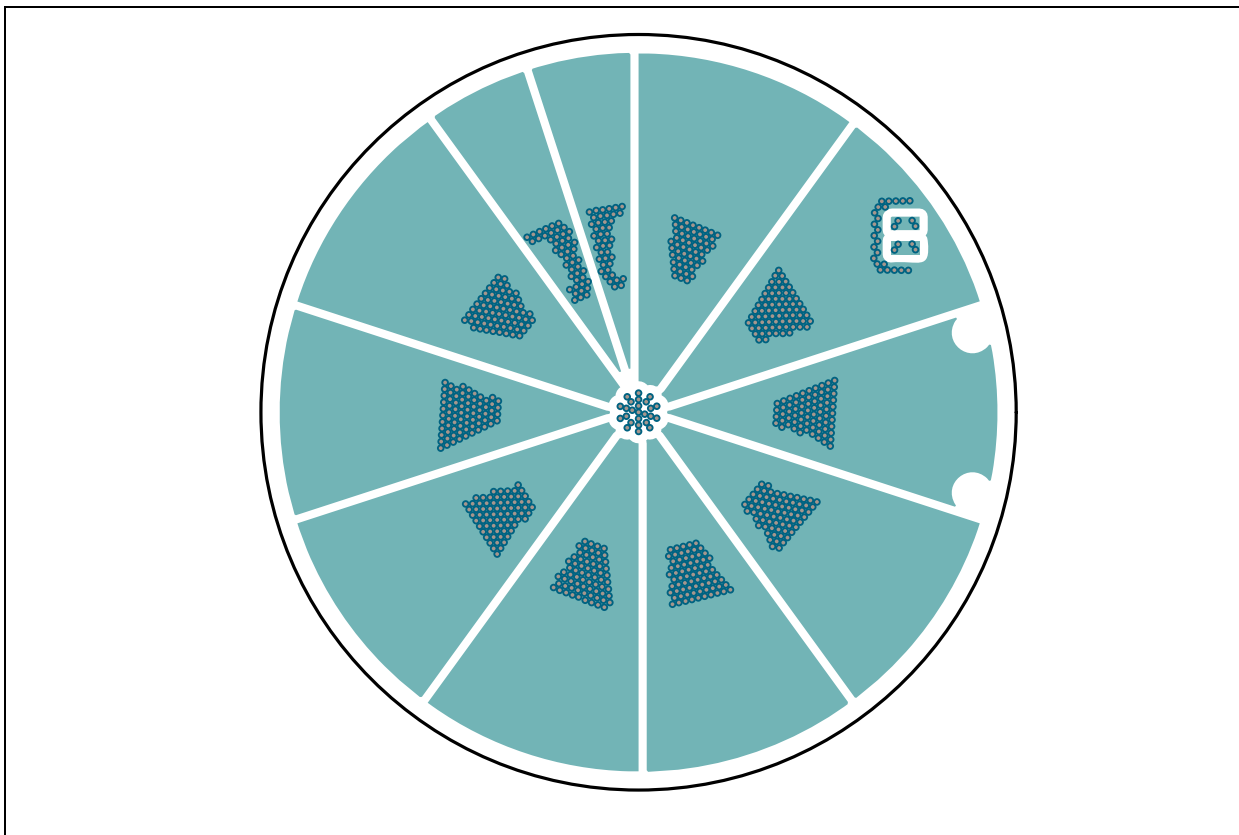

A.14 ADM00767 – BOTTOM COPPER AND SILK

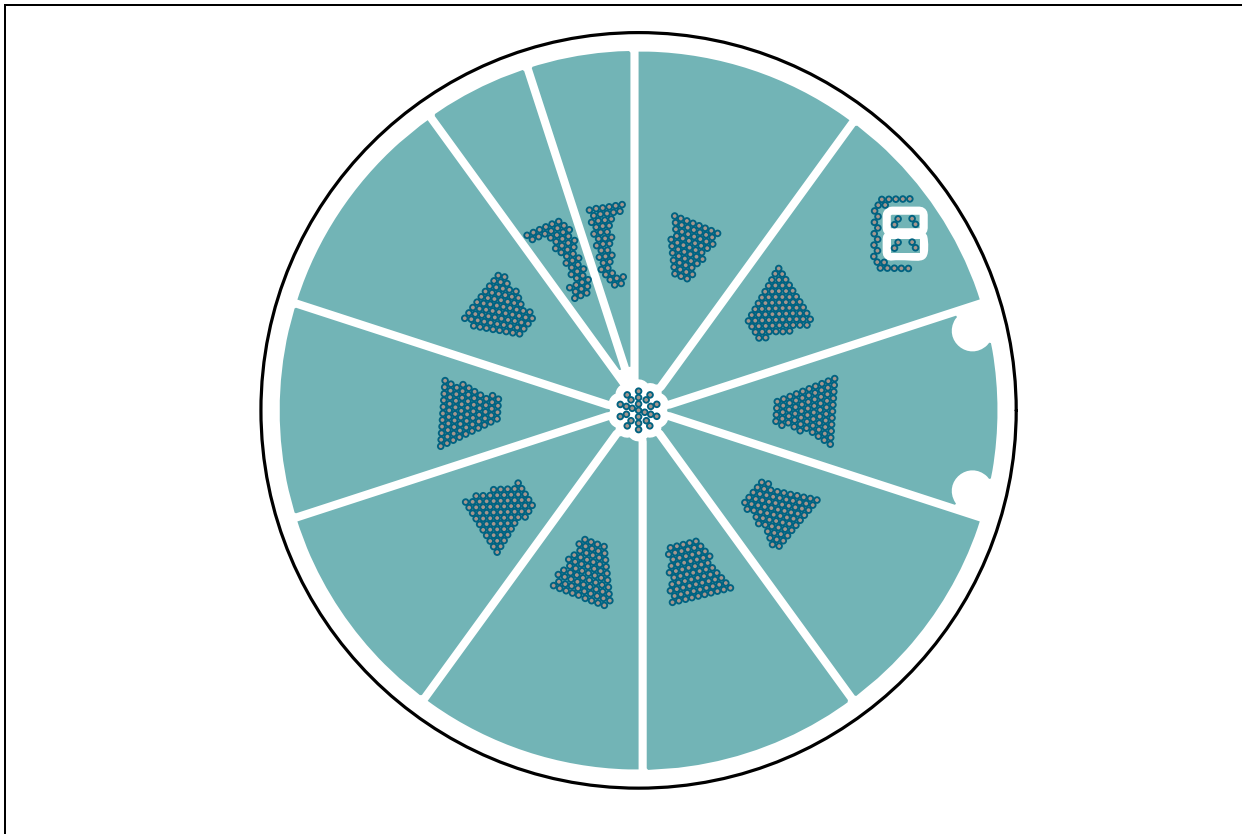

A.15 ADM00767 – BOTTOM SILK

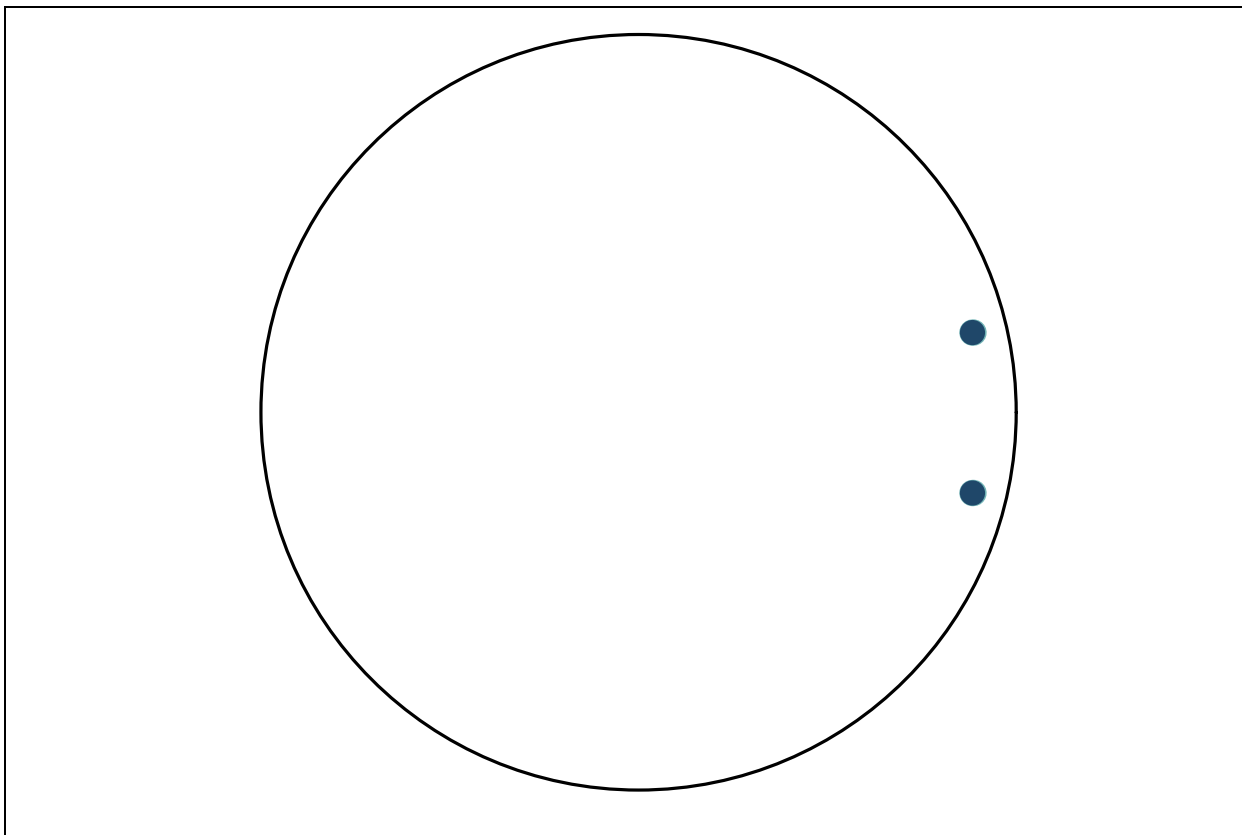

NOTES:

Appendix B. Bill of Materials (BOM)

TABLE B-1: BILL OF MATERIALS (BOM) FOR CL88020 LED DRIVER EVALUATION BOARD (ADM00766)⁽¹⁾

Qty.	Reference	Description	Manufacturer	Part Number
2	C1, C4	Capacitor ceramic 4.7 μ F, 25V, 10%, X7R, SMD, 0805	TDK Corporation	C2012X7R1E475K125AB
2	C2, C3	Capacitor ceramic, 15 μ F, 20%, X7S, SMD, 2220	TDK Corporation	C5750X7S2A156M250KB
1	D1	Diode, bridge rectifier, MB6S, 1V, 0.5A, 600V, SMD, SOIC-4	Fairchild Semiconductor [®]	MB6S
2	D2, D3	Diode, bridge rectifier, MMBD1503A 1.1V, 200 mA, 200V, SMD, SOT-23-3	Fairchild Semiconductor [®]	MMBD1503A
1	J1	Terminal block, 5.08 mm, 1x2, female, 16-22AWG, 12A, TH, R/A	On-Shore Technology, Inc.	OSTHD020080
1	J2	Header 8 positions, HDR-1.27, male, 1x8, Tin, SMD, vertical	Molex [®]	908140808
1	IC1	Microchip Analog CL88020 LED Driver, SOIC-8	Microchip Technology Inc.	CL88020T-E/SE
1	MOV1	Resistor varistor, 240V, 250 mW, SMD, 4032	EPCOS AG	CU4032K150G2K1
3	R1, R2, R9	Resistor TKF, 0R, 1%, 1/4W, SMD, 1206	TT ElectronicsPlc.	WCR1206-R005JI
2	R3, R4	Resistor TKF, 10R, 5%, 1W, SMD, 2512	Panasonic [®] - BSG	ERJ-1TYJ100U
1	R5	Resistor TKF, 1M, 1%, 1/8W, SMD, 0805	Panasonic [®] - BSG	ERJ-6ENF1004V
1	R6	Resistor TKF, 28 k Ω 1%, 1/8W, SMD, 0805	Vishay Dale	CRCW080528K0FKEA
1	R7	Resistor TKF, 100 k Ω , 1%, 1/4W, SMD, 1206	Panasonic	ERJ-8ENF1003V
1	R8	Resistor TKF, 221 k Ω , 1%, 1/8W, SMD, 0805	Vishay/Dale	CRCW0805221KFKEA
1	R10	Resistor TKF, 7.5R, 1%, 1/8W, SMD, 0805	Vishay/Dale	CRCW08057R50FKEA
1	R11	Resistor TKF, 3.24R, 1%, 1/8W, SMD, 0805	Vishay/Dale	CRCW08053R24FKEA
2	TP1, TP2	Test points, multi-purpose, mini, black	Keystone Electronics Corp.	5001

Note 1: The components listed in this Bill of Materials are representative of the PCB assembly. The released BOM used in manufacturing uses all RoHS-compliant components.

CL88020 120 V_{AC} Offline LED Driver Evaluation Board User's Guide

TABLE B-2: BILL OF MATERIALS (BOM) FOR CL88020 LED DRIVER EVALUATION BOARD (ADM00766) - MECHANICAL PARTS⁽¹⁾

Qty.	Reference	Description	Manufacturer	Part Number
1	CBL1	Mechanical cable, Picoflex, IDT to IDT, 8-COND, 250 mm	Molex®	92315-0825
1	HS1	Mechanical HW, heat sink adhesive tape, L19W19H6.3	CTS® Corporation	APF19-19-06CB/A01
1	PCB	Printed Circuit Board - CL88020 LED Driver Evaluation Board (ADM00766)	Microchip Technology Inc.	04-10559-R1
4	SCR1, SCR2, SCR3, SCR4	Mechanical HW, screw #6-32 x 1/4", PanHead, PHIL, nylon	B&F™ Fasteners Supply	NY PMS 632 0025 PH
4	STANDOFF1, STANDOFF2, STANDOFF3, STANDOFF4	Mechanical HW, stand-off, #6-32 x 3/8", F, HEX, nylon	Keystone Electronics Corp.	1903B

Note 1: The components listed in this Bill of Materials are representative of the PCB assembly. The released BOM used in manufacturing uses all RoHS-compliant components.

TABLE B-3: BILL OF MATERIALS (BOM) FOR CL88020 LED LOAD BOARD (ADM00767)⁽¹⁾

Qty.	Reference	Description	Manufacturer	Part Number
1	J3	CON HDR-1.27, male, 1x8, Tin, SMD, vertical	Molex®	0908140808
10	LD1, LD2, LD3, LD4, LD5, LD6, LD7, LD8, LD9, LD10	Diode LED, white, 24.8V, 150 mA, 500 lm, 3000K, SMD, L5W5H0.7	OSRAM Opto Semiconductors GmbH.	GW P9LR31.EM-PPPR-XX57-1
1	R1	Resistor thermistor, 470 kΩ, 5%, 100 mW, 0603	Murata Electronics®	NCP18WM474J03RB

Note 1: The components listed in this Bill of Materials are representative of the PCB assembly. The released BOM used in manufacturing uses all RoHS-compliant components.

TABLE B-4: BILL OF MATERIALS (BOM) FOR CL88020 LED LOAD BOARD (ADM00767) - MECHANICAL PARTS⁽¹⁾

Qty.	Reference	Description	Manufacturer	Part Number
1	HS2	Mechanical HW, heat sink, D60 mm x H30 mm, 9.1W, black	MechaTronix Kaohsiung Co., Ltd.	LPF60A30-5-B
1	PCB	Assembled Printed Circuit Board - CL88020 LED Load Board (ADM00767)	Microchip Technology Inc.	04-10560-R1
1	TAPE1	Mechanical HW, tape, thermal sheet, 0.0625 mm, L254W254	Bergquist Company GmbH	BP100-0 008-00-1010

Note 1: The components listed in this Bill of Materials are representative of the PCB assembly. The released BOM used in manufacturing uses all RoHS-compliant components.

Appendix C. CL88020

120 V_{AC} Offline LED Driver Evaluation Board User's Guide Waveforms

C.1 CL88020 120 V_{AC} OFF-LINE LED DRIVER EVALUATION BOARD TYPICAL WAVEFORMS

C.1.1 Total Output Current on 110, 120, 138 V_{AC} RMS Input

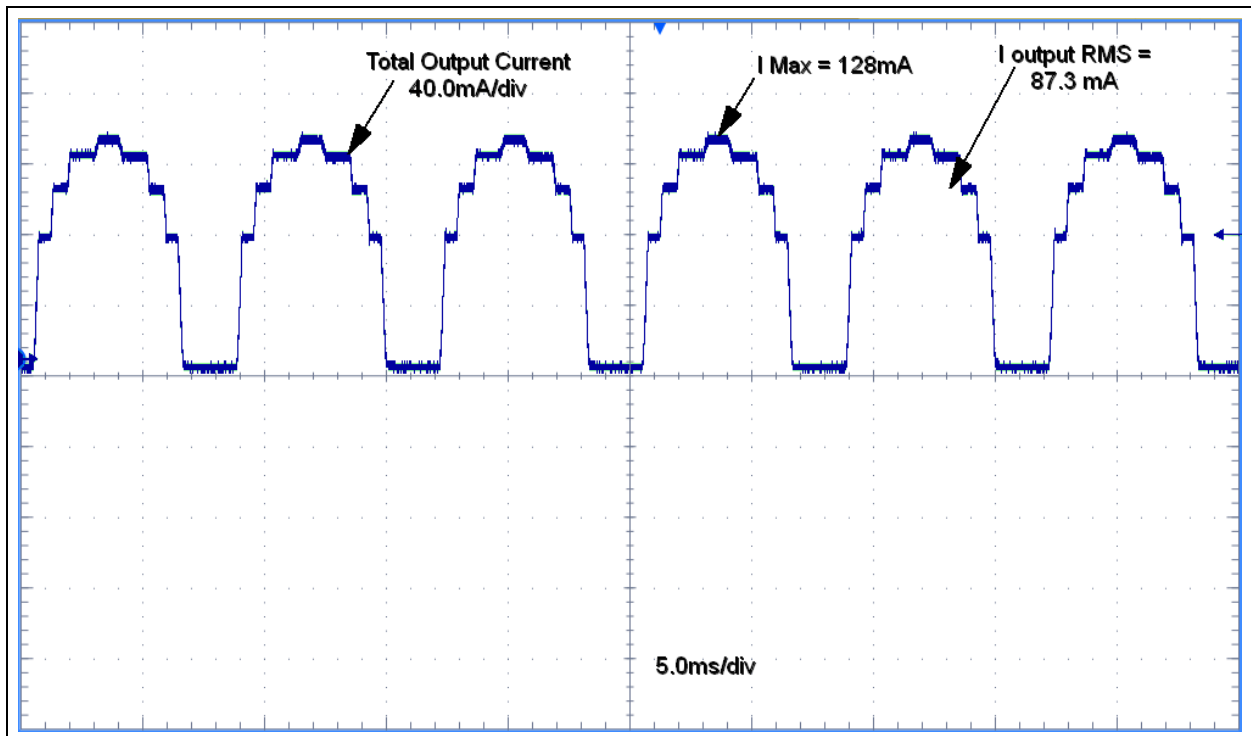

FIGURE C-1: Total Output Current at 110 V_{AC}.

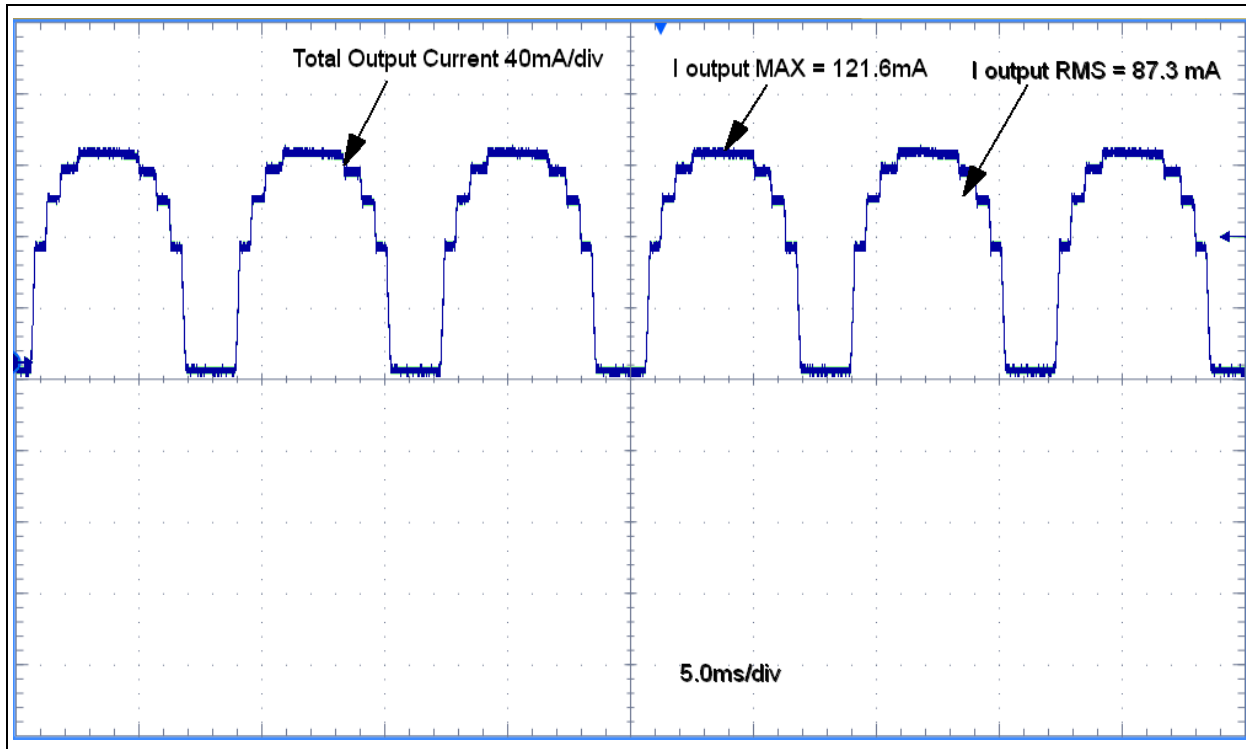

FIGURE C-2: Total Output Current at 120 V_{AC} RMS.

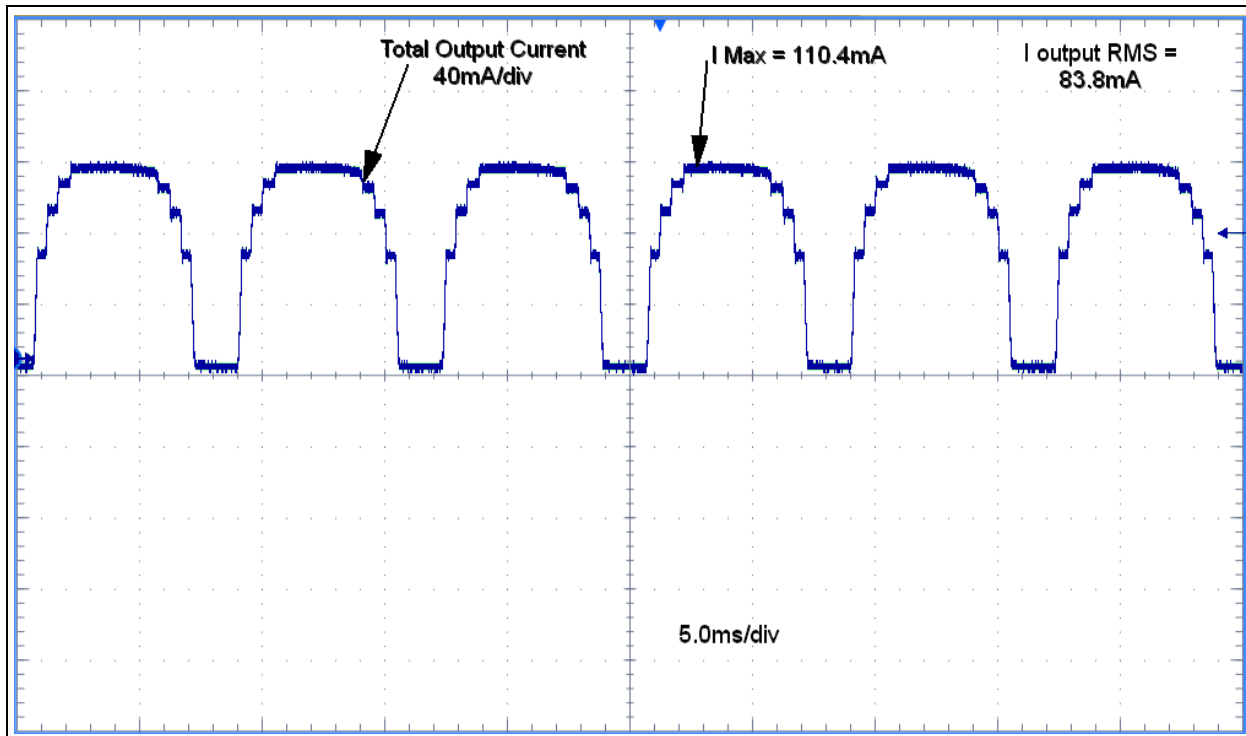

FIGURE C-3: Total Output Current at 138 V_{AC} RMS.

C.1.2 TAPs 1, 2, 3, 4 Currents at 120 V_{AC} RMS

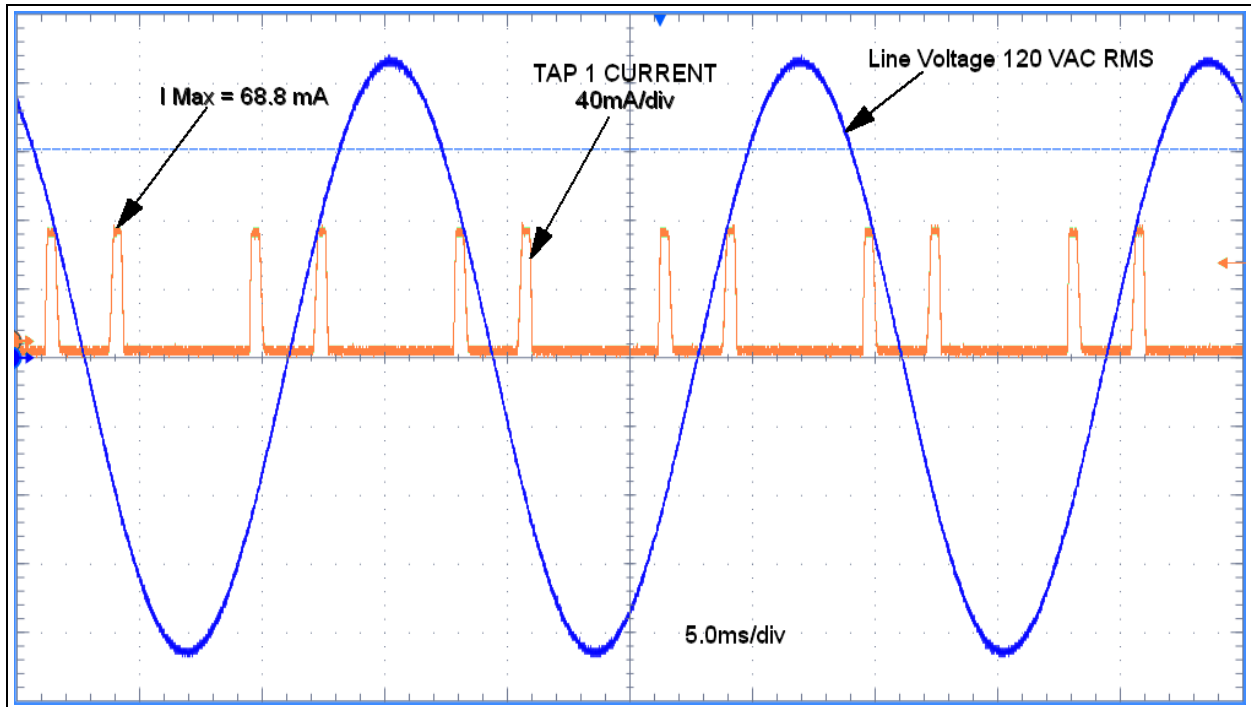

FIGURE C-4: TAP1 Current and Line Voltage at 120 V_{AC} RMS.

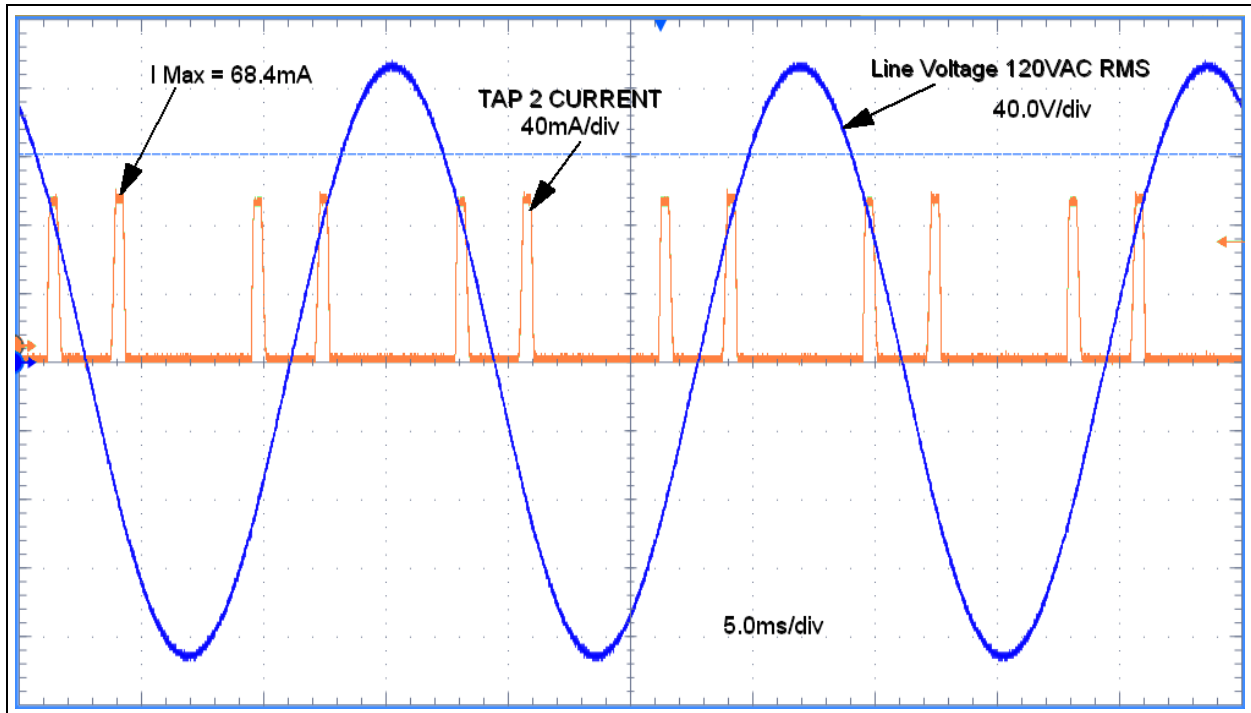

FIGURE C-5: TAP2 Current and Line Voltage at 120 V_{AC} RMS.

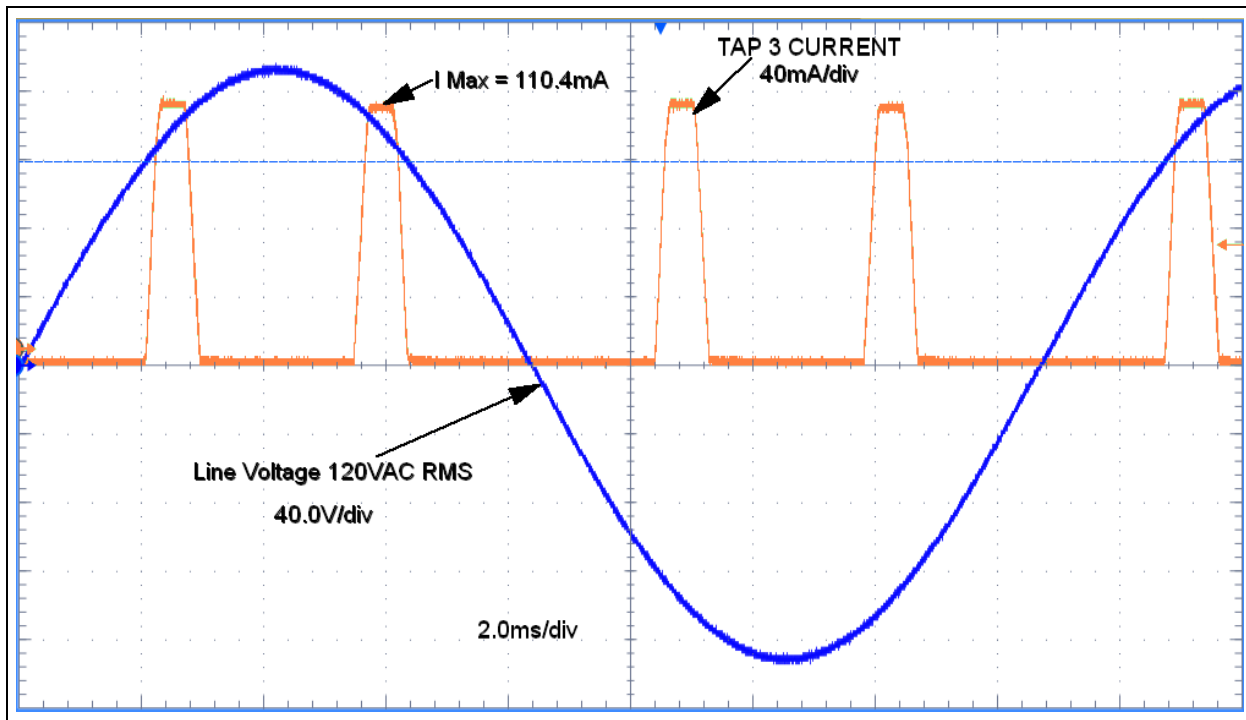

FIGURE C-6: TAP3 Current and Line Voltage at 120 V_{AC} RMS.

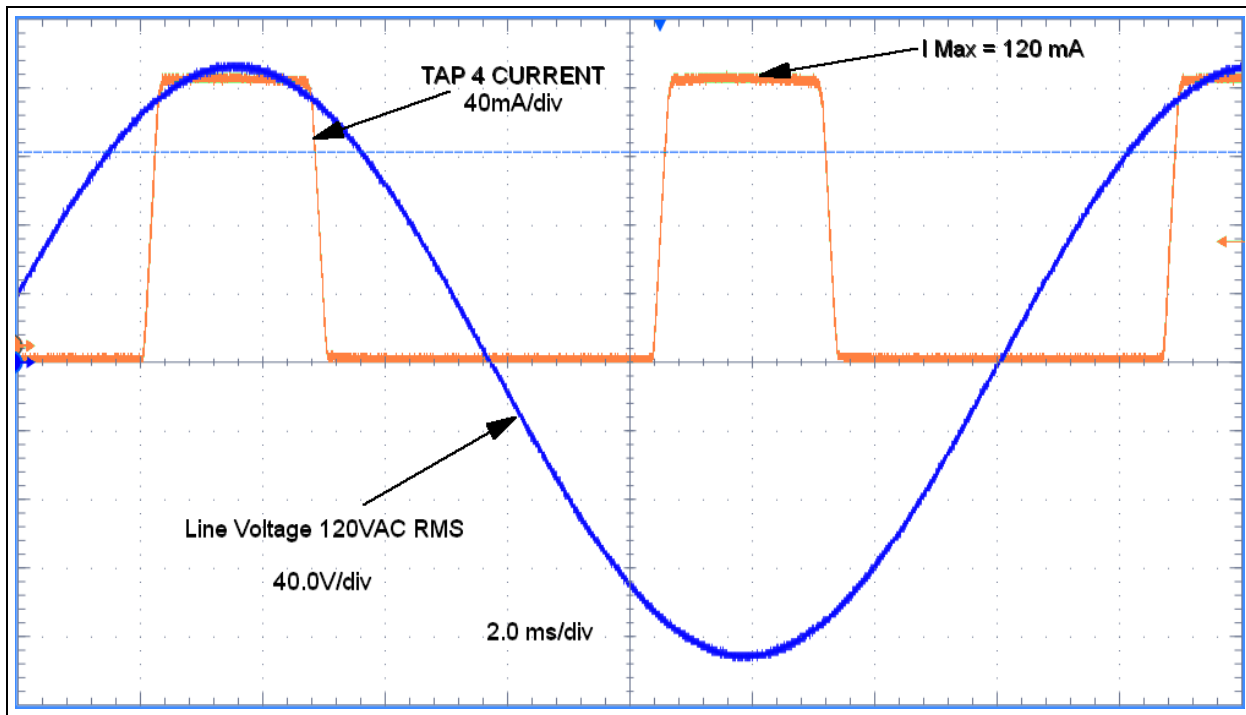

FIGURE C-7: TAP4 Current and Line Voltage at 120 V_{AC} RMS.

C.1.3 Output Current on Startup at 110, 120 and 135 V_{AC} RMS Input

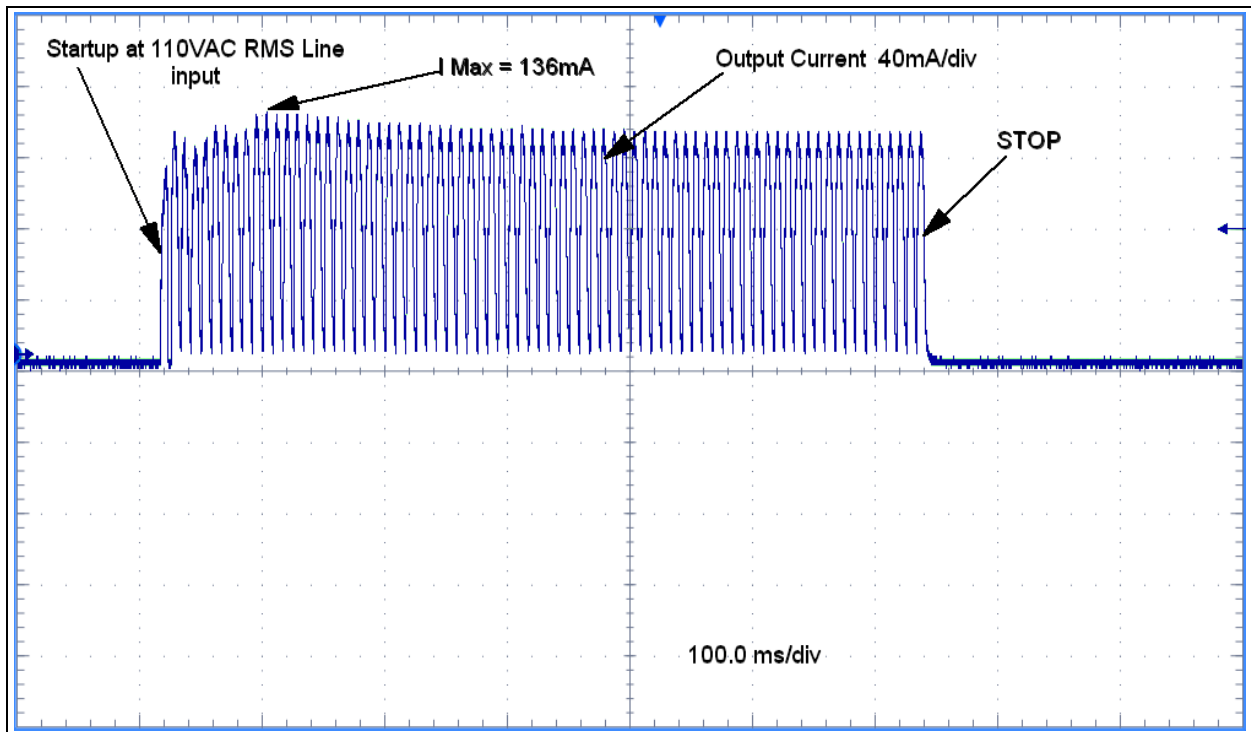

FIGURE C-8: Output Current on Startup at 110 V_{AC} RMS Line Input.

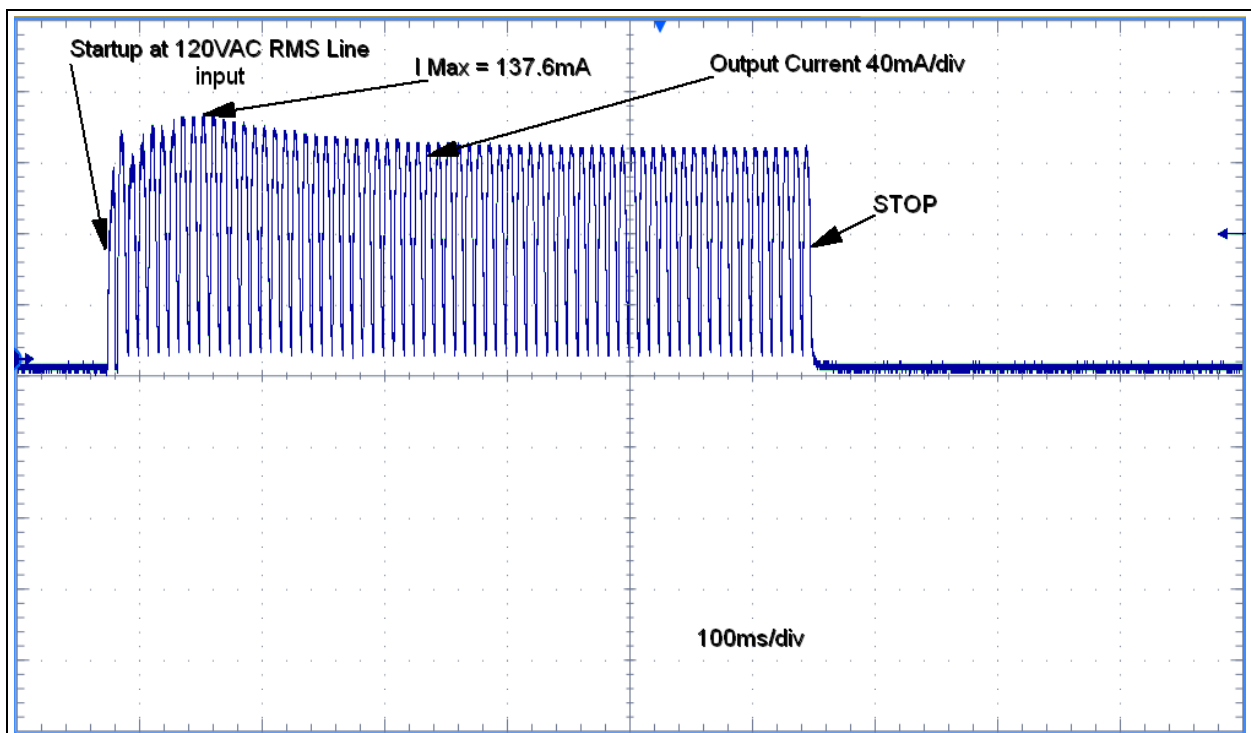

FIGURE C-9: Output Current on Startup at 120 V_{AC} RMS Line Input.

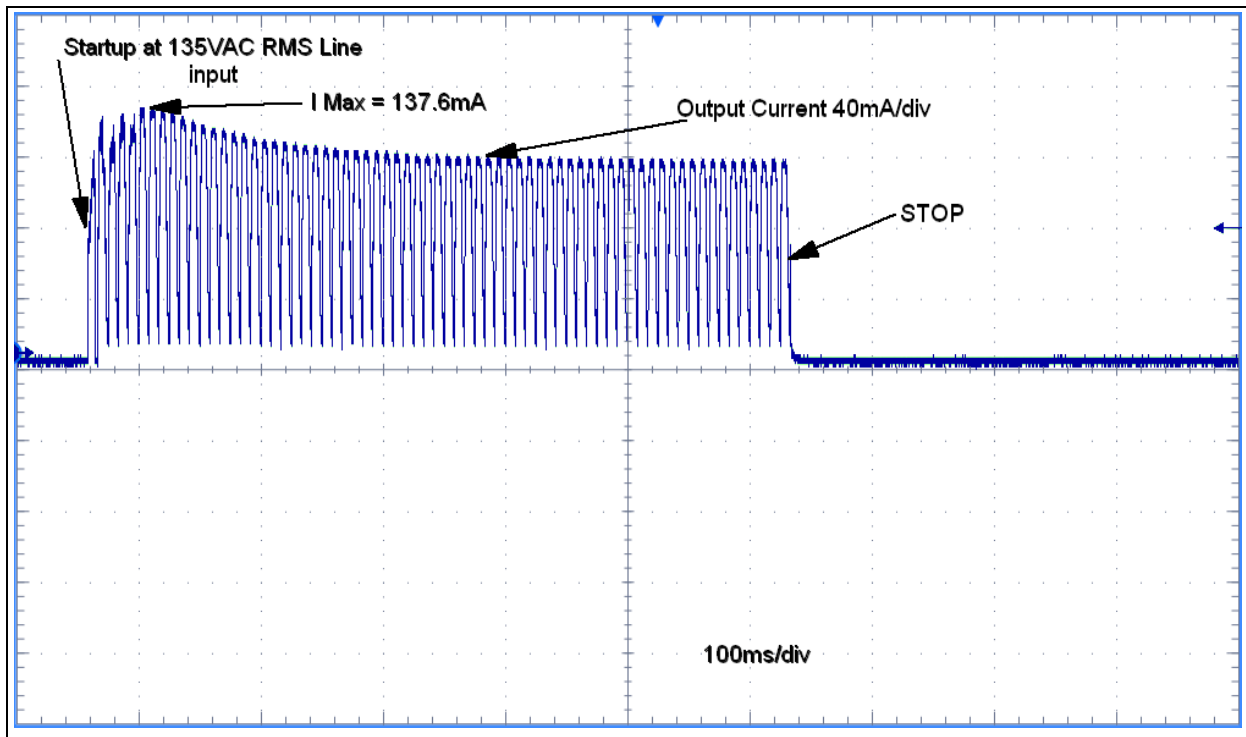

FIGURE C-10: Output Current on Startup at 135 V_{AC} RMS Line Input.

C.1.4 Input Current and Input Voltage Waveforms at 120 V_{AC} RMS Input

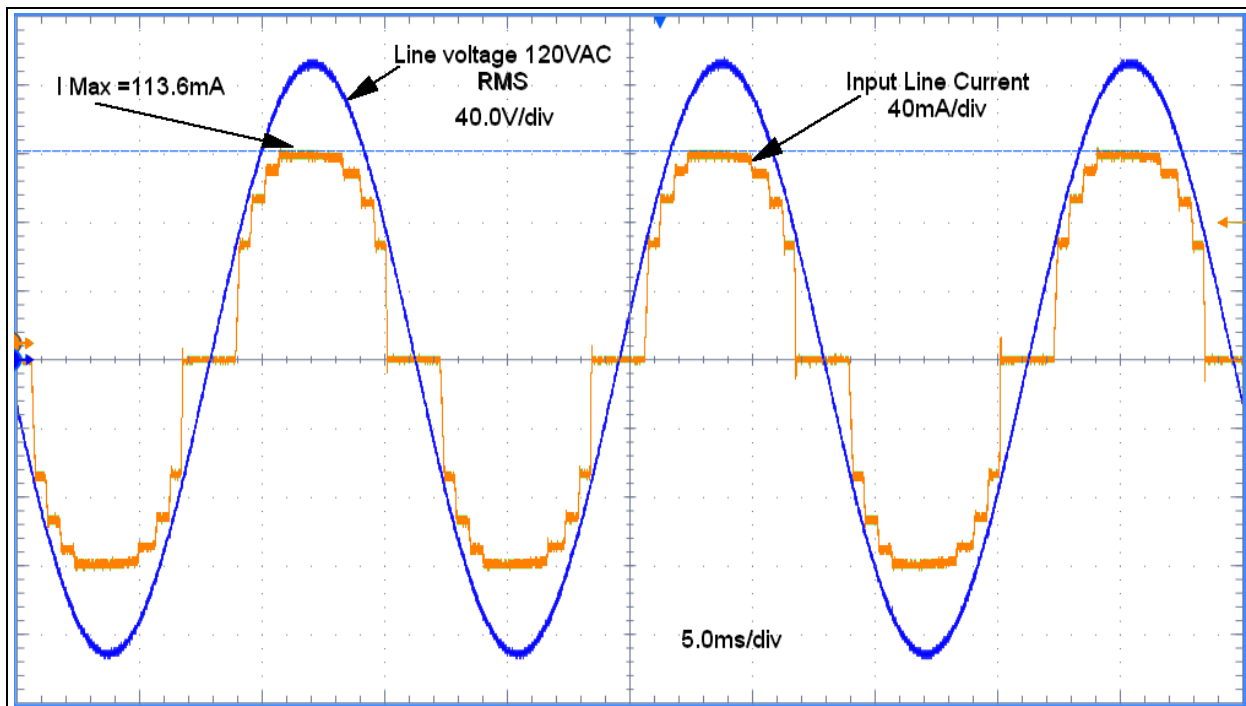

FIGURE C-11: Input Current and Input Voltage Waveforms at 120 V_{AC} RMS Input.

C.1.5 Input Current Waveforms, Detail at 120 V_{AC} RMS Input Line Voltage

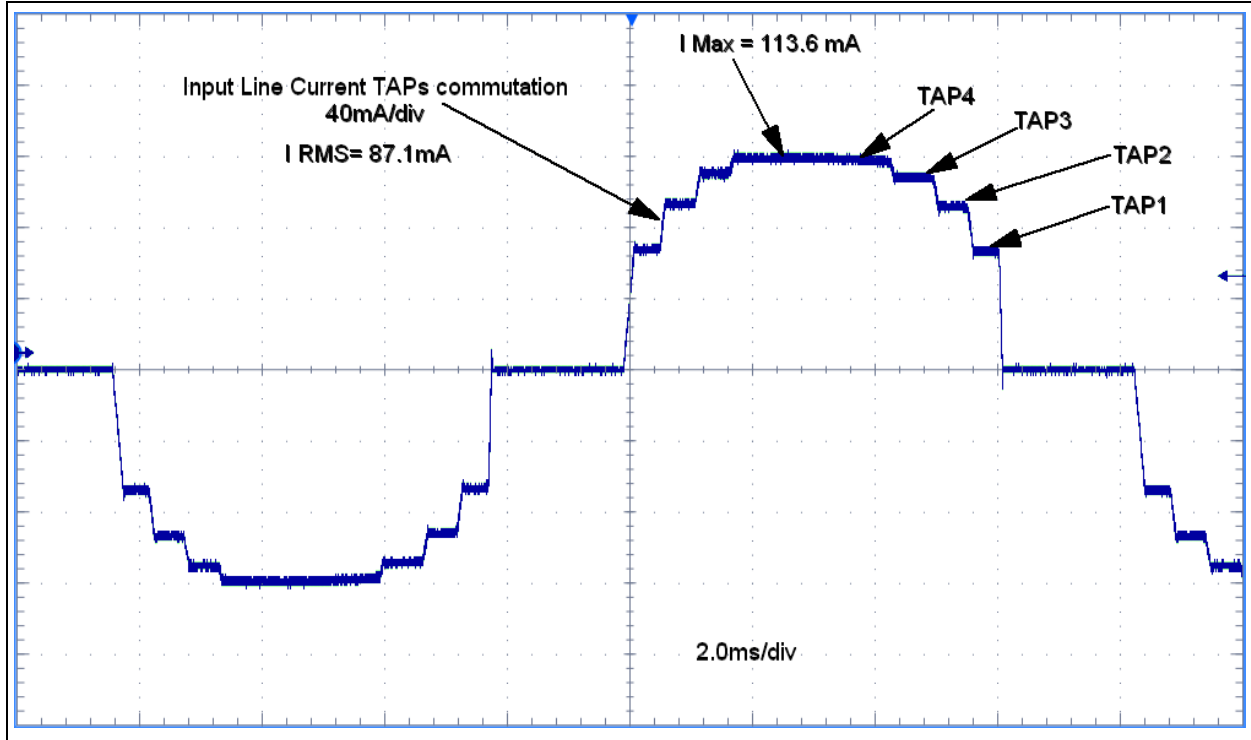

FIGURE C-12: Input Current Waveform-TAPs Commutation.

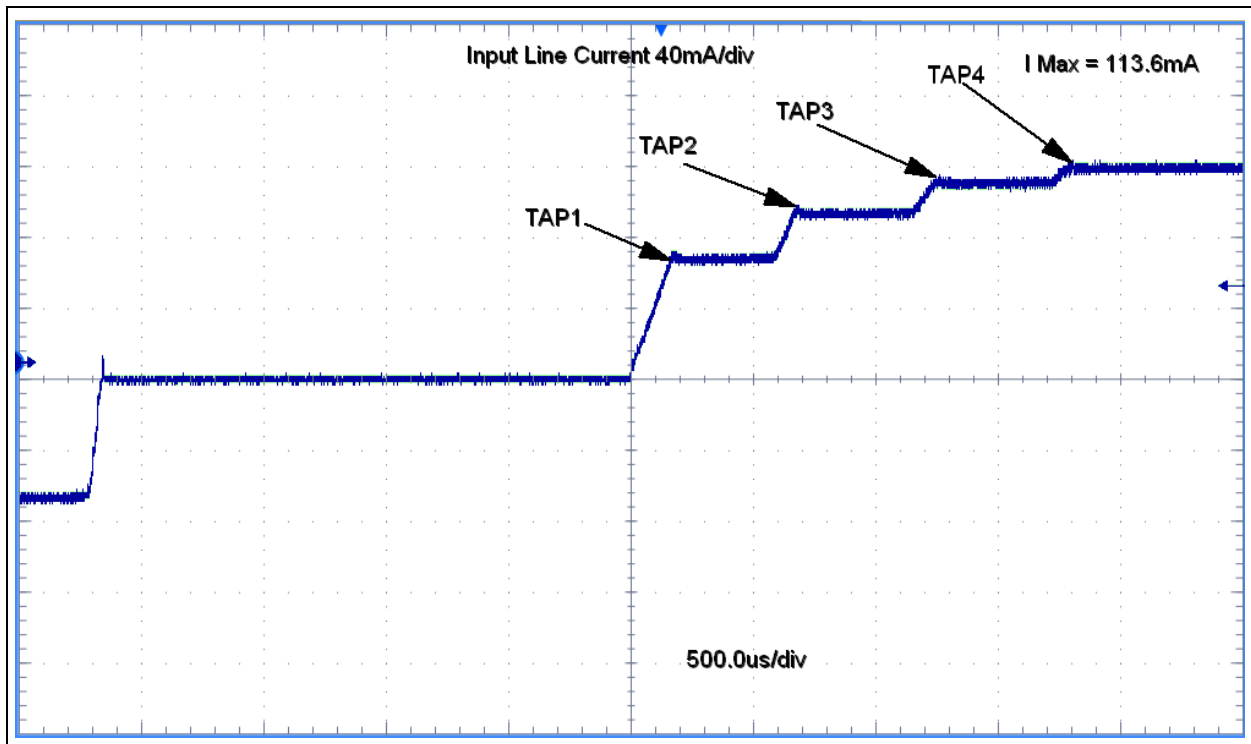

FIGURE C-13: Input Current Waveform - TAPs Commutation Detail.

C.1.6 Output Current with/without Ripple Reduction Circuit at 120 V_{AC} RMS Input

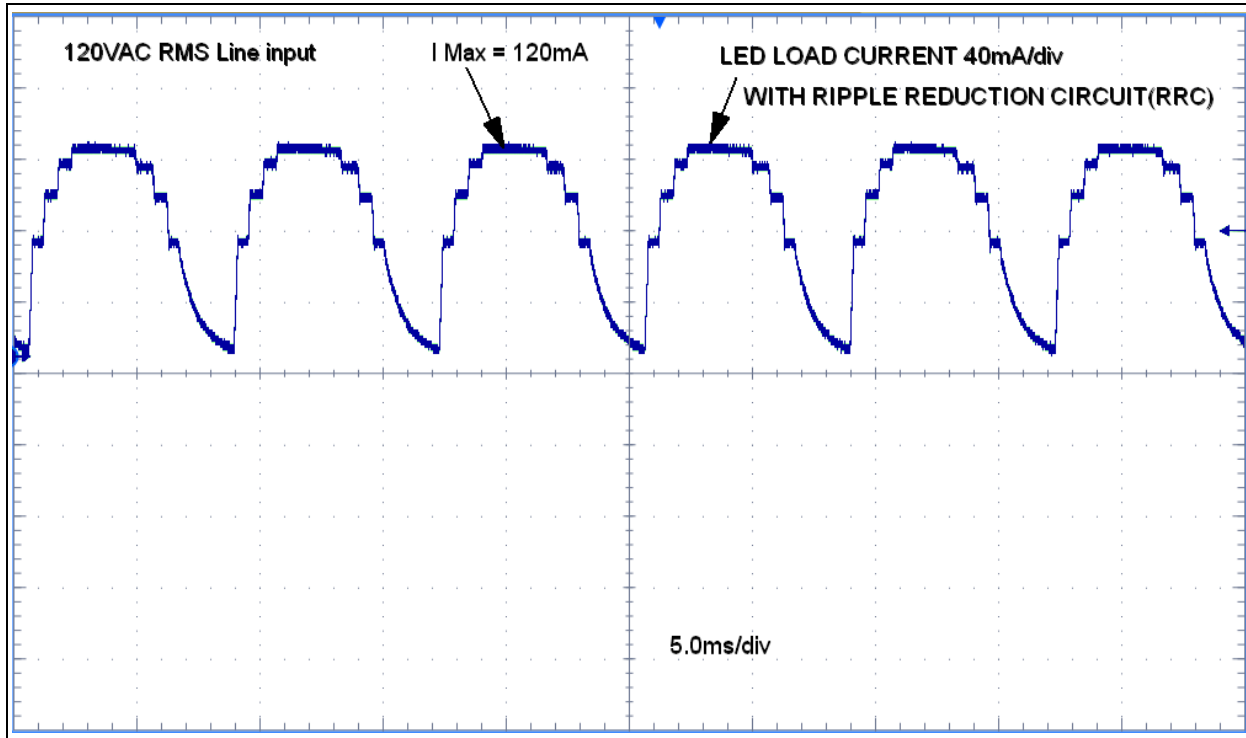

FIGURE C-14: Output Current with Ripple Reduction Circuit on 120 V_{AC} RMS Input.

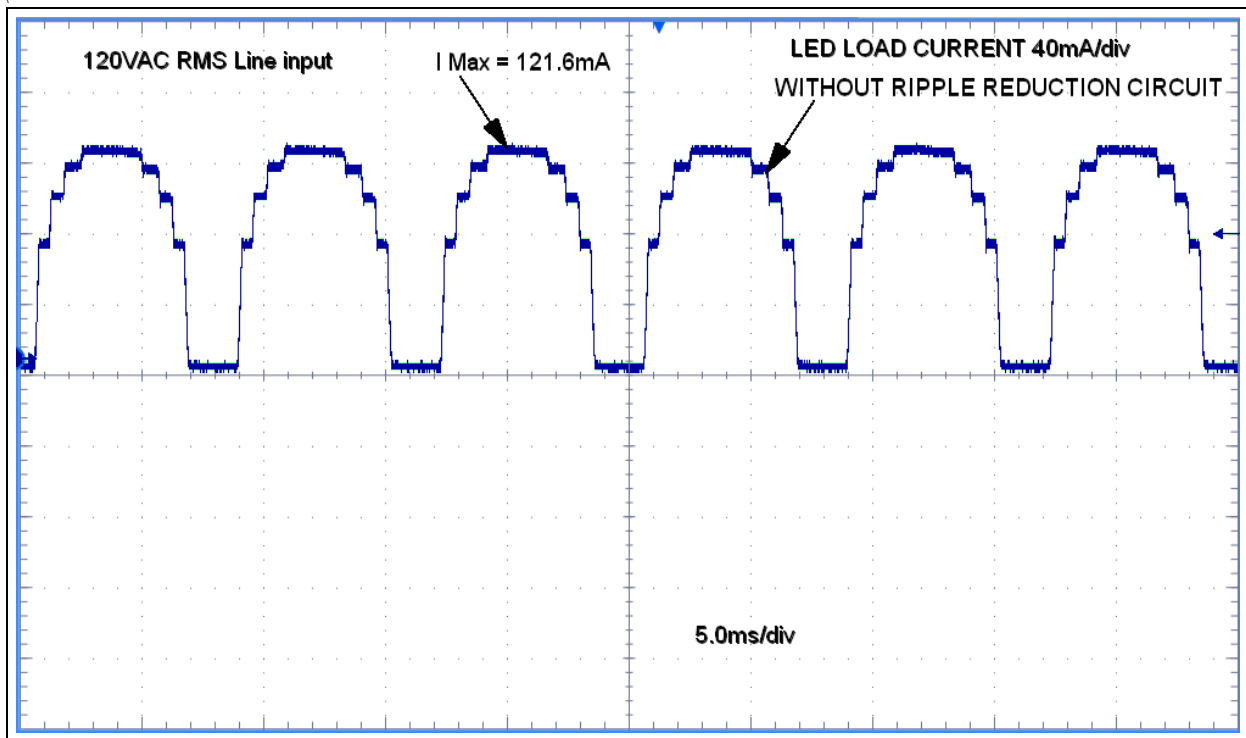

FIGURE C-15: Output Current without Ripple Reduction Circuit at 120 V_{AC} RMS Input.

C.2 BOARD SET TYPICAL MEASUREMENTS

Note: The graphs and tables provided following this note are a statistical summary based on a limited number of samples and are provided for informational purposes only. The performance characteristics listed herein are not tested or guaranteed. In some graphs or tables, the data presented may be outside the specified operating range (e.g., outside specified power supply range) and therefore, outside the warranted range.

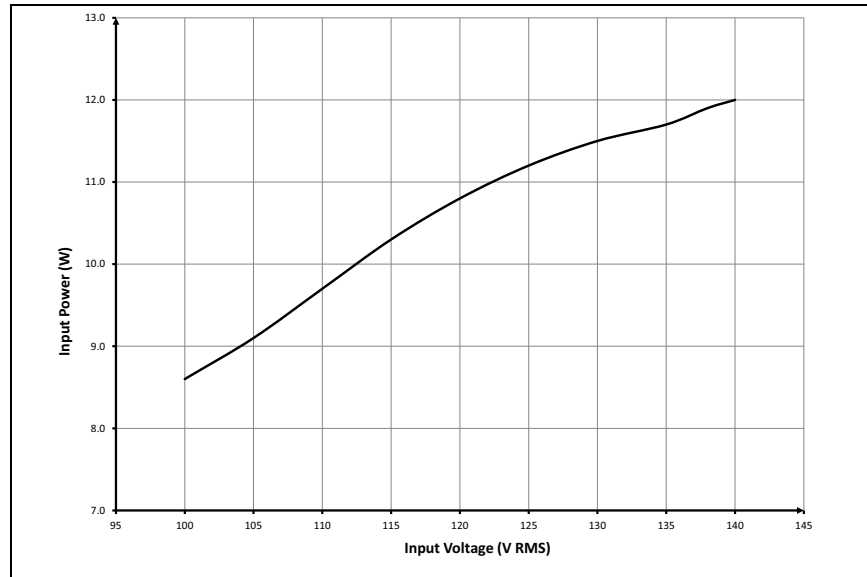

FIGURE C-16: *Input Power vs. Input Line Voltage.*

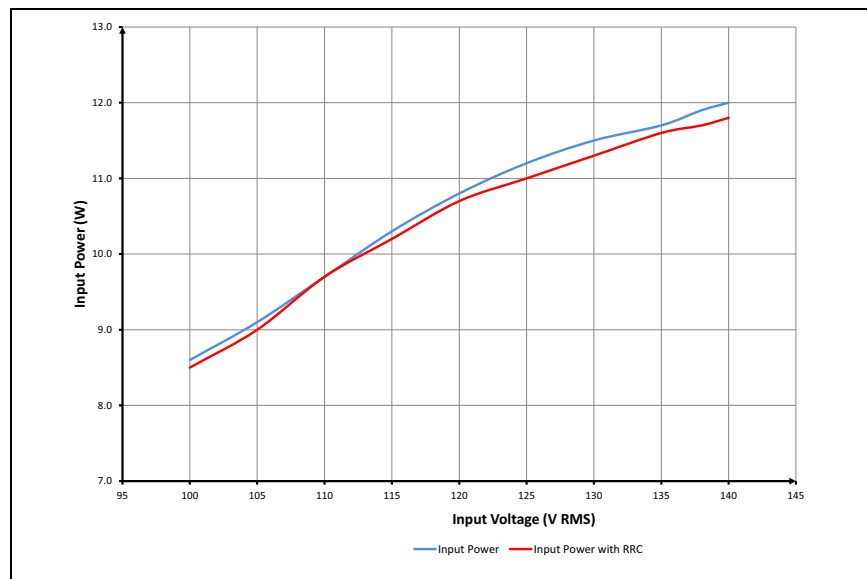

FIGURE C-17: *Input Power vs. Input Line Voltage.*

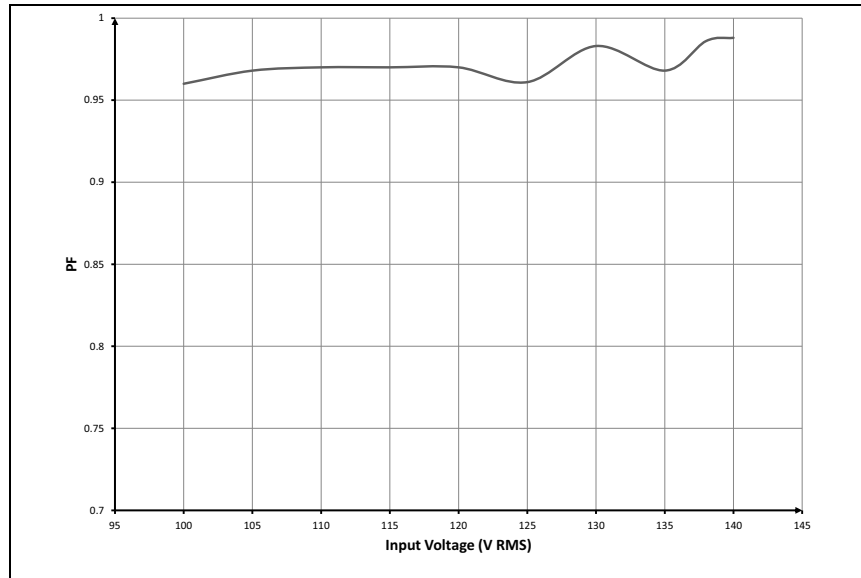

FIGURE C-18: Power Factor.

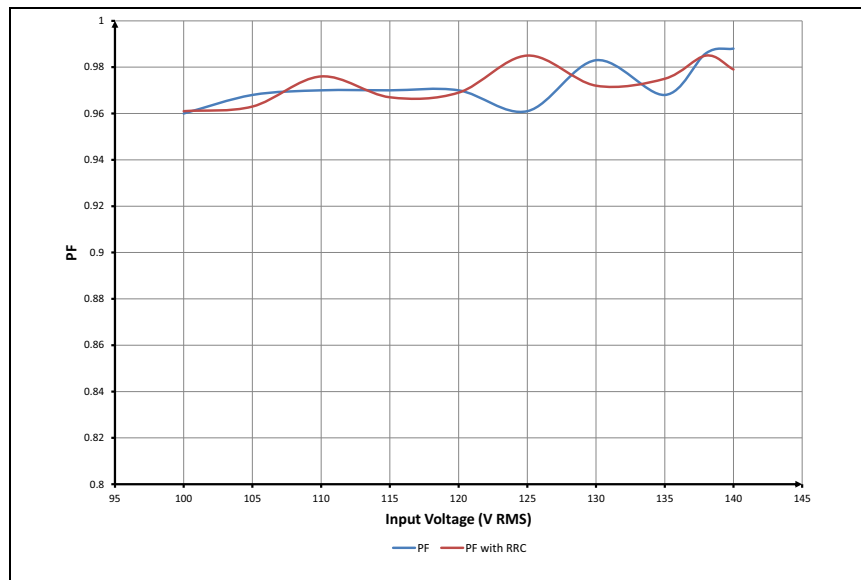

FIGURE C-19: Power Factor.

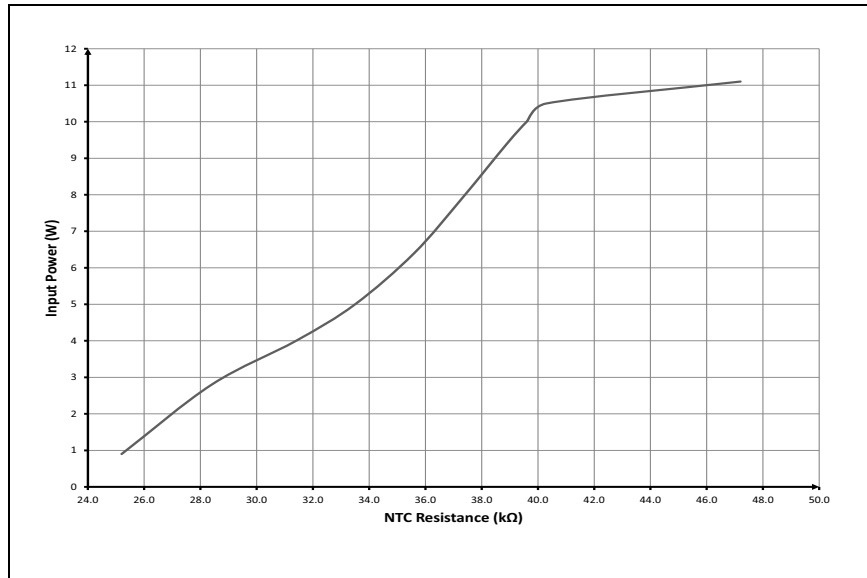

FIGURE C-20: *Input Power vs. NTC Resistance.*

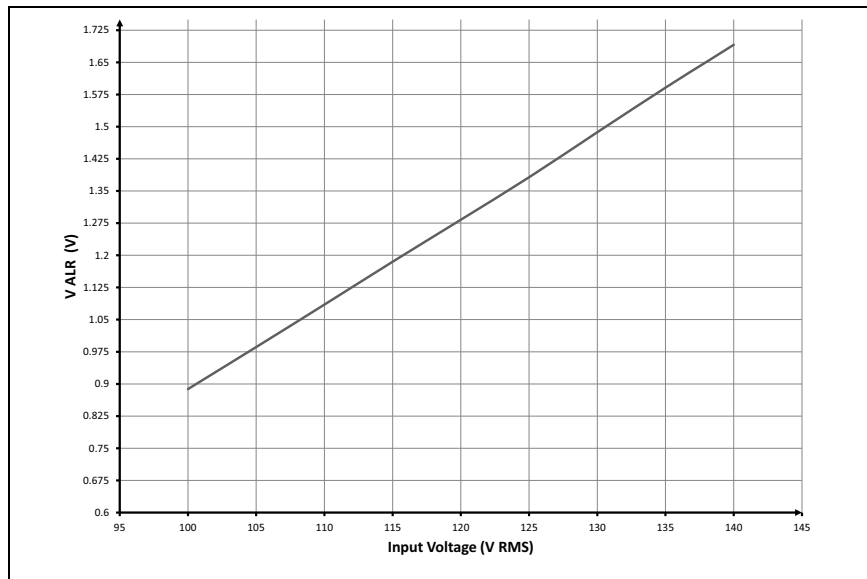

FIGURE C-21: *V_{ALR PIN} vs. Input Line Voltage.*

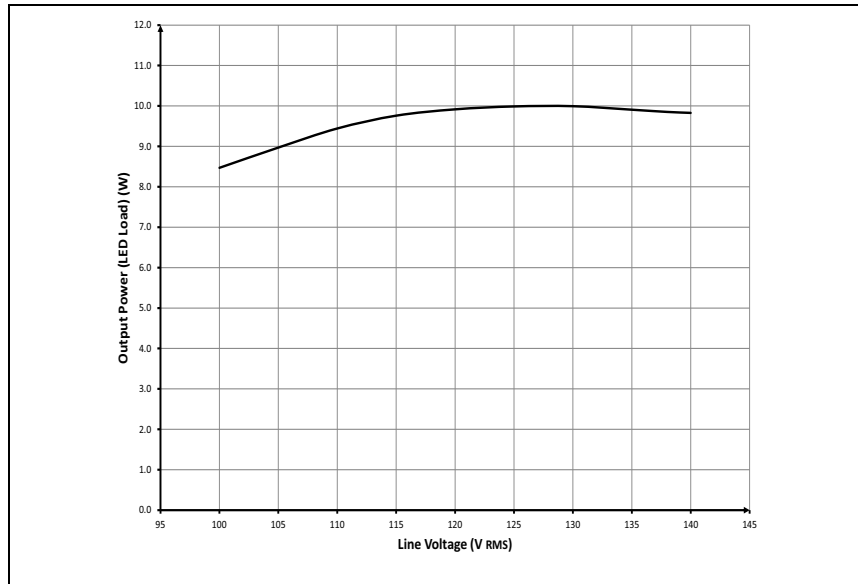

FIGURE C-22: Output Power vs. Input Line Voltage.

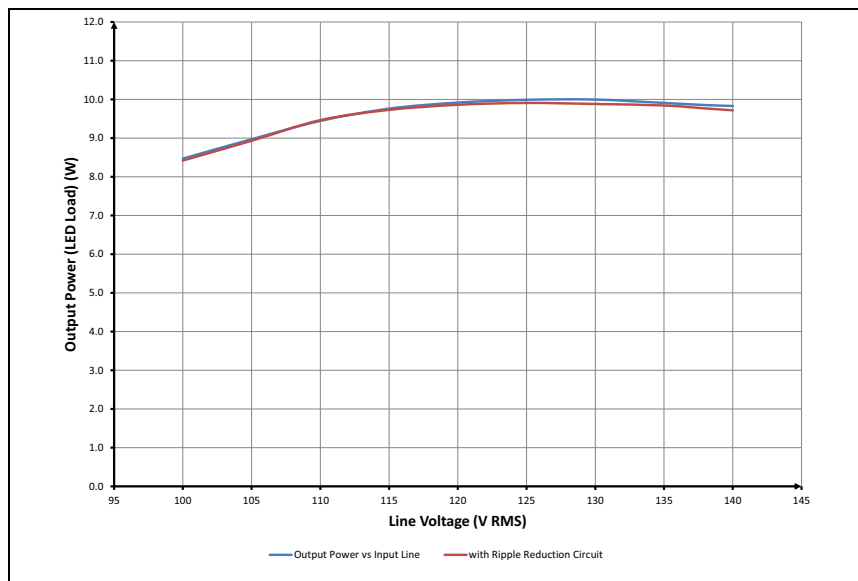

FIGURE C-23: Output Power vs. Input Line Voltage.

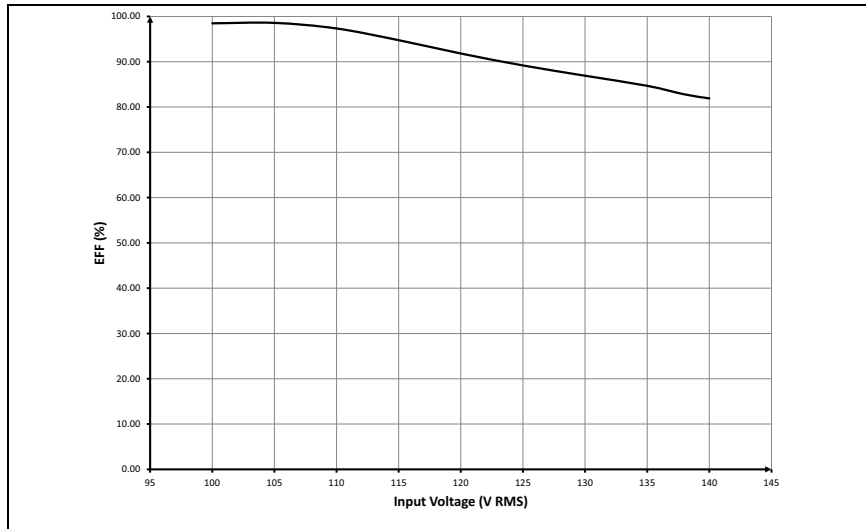

FIGURE C-24: Efficiency.

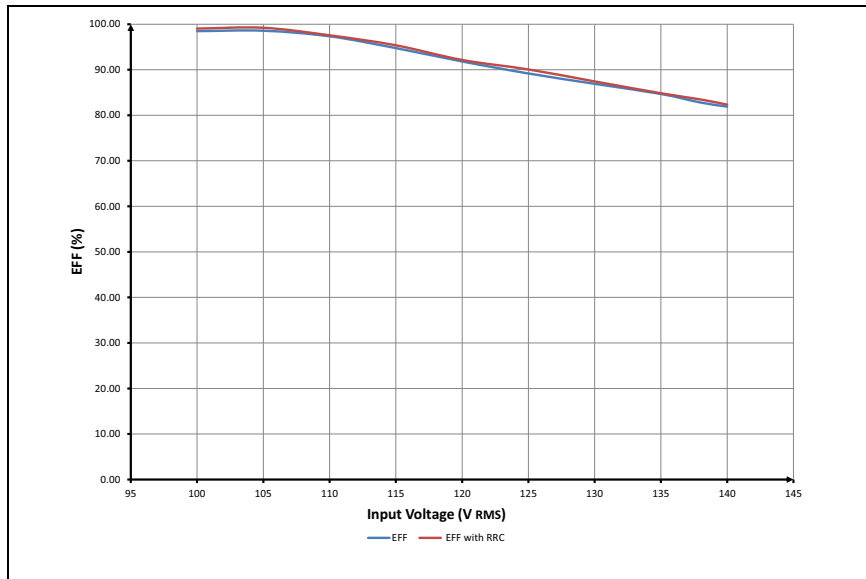

FIGURE C-25: Efficiency.

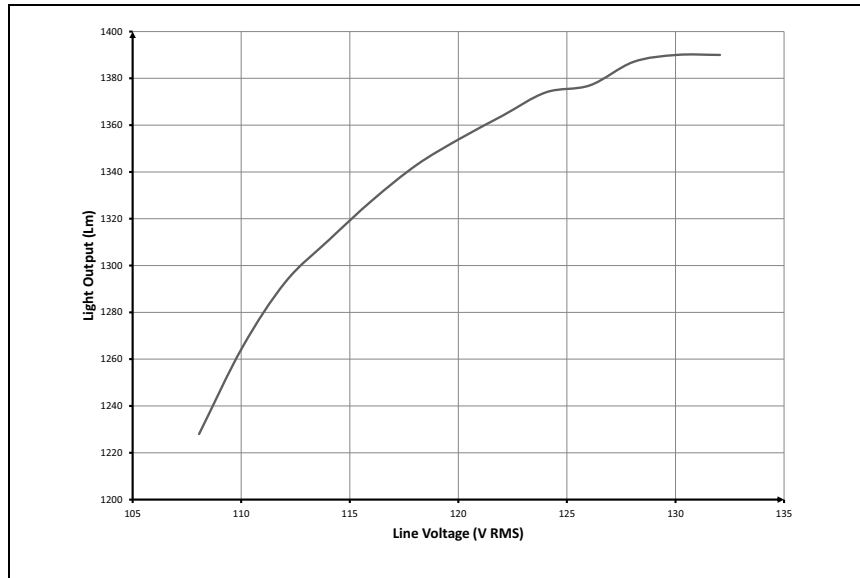

FIGURE C-26: *Light Output vs. Input Line Voltage.*

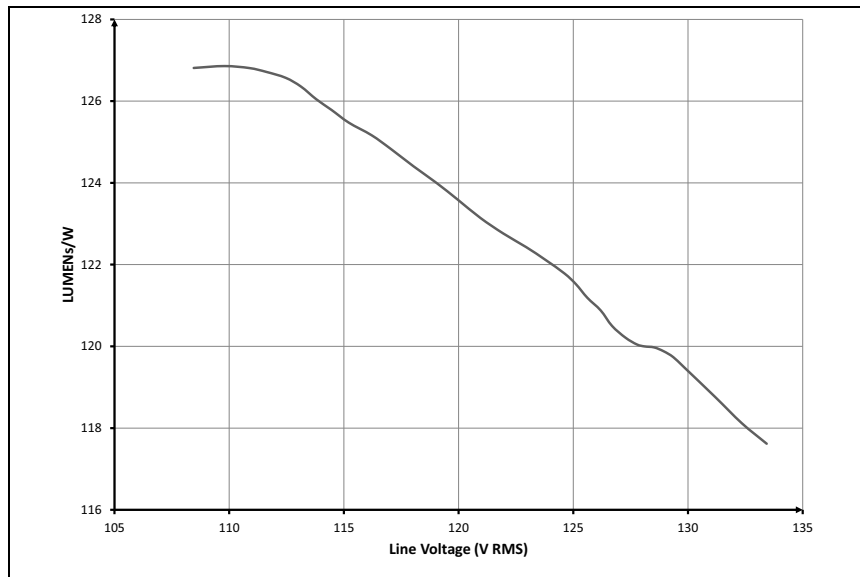

FIGURE C-27: *Efficacy.*



MICROCHIP

Worldwide Sales and Service

AMERICAS

Corporate Office

2355 West Chandler Blvd.
Chandler, AZ 85224-6199
Tel: 480-792-7200
Fax: 480-792-7277
Technical Support:
<http://www.microchip.com/support>

Web Address:
www.microchip.com

Atlanta

Duluth, GA
Tel: 678-957-9614
Fax: 678-957-1455

Austin, TX

Tel: 512-257-3370

Boston

Westborough, MA
Tel: 774-760-0087
Fax: 774-760-0088

Chicago

Itasca, IL
Tel: 630-285-0071
Fax: 630-285-0075

Dallas

Addison, TX
Tel: 972-818-7423
Fax: 972-818-2924

Detroit

Novi, MI
Tel: 248-848-4000

Houston, TX

Tel: 281-894-5983

Indianapolis

Noblesville, IN
Tel: 317-773-8323
Fax: 317-773-5453
Tel: 317-536-2380

Los Angeles

Mission Viejo, CA
Tel: 949-462-9523
Fax: 949-462-9608
Tel: 951-273-7800

Raleigh, NC

Tel: 919-844-7510

New York, NY

Tel: 631-435-6000

San Jose, CA

Tel: 408-735-9110
Tel: 408-436-4270

Canada - Toronto

Tel: 905-695-1980
Fax: 905-695-2078

ASIA/PACIFIC

Asia Pacific Office

Suites 3707-14, 37th Floor
Tower 6, The Gateway
Harbour City, Kowloon

Hong Kong

Tel: 852-2943-5100
Fax: 852-2401-3431

Australia - Sydney

Tel: 61-2-9868-6733
Fax: 61-2-9868-6755

China - Beijing

Tel: 86-10-8569-7000
Fax: 86-10-8528-2104

China - Chengdu

Tel: 86-28-8665-5511
Fax: 86-28-8665-7889

China - Chongqing

Tel: 86-23-8980-9588
Fax: 86-23-8980-9500

China - Dongguan

Tel: 86-769-8702-9880

China - Guangzhou

Tel: 86-20-8755-8029

China - Hangzhou

Tel: 86-571-8792-8115
Fax: 86-571-8792-8116

China - Hong Kong SAR

Tel: 852-2943-5100
Fax: 852-2401-3431

China - Nanjing

Tel: 86-25-8473-2460
Fax: 86-25-8473-2470

China - Qingdao

Tel: 86-532-8502-7355
Fax: 86-532-8502-7205

China - Shanghai

Tel: 86-21-3326-8000
Fax: 86-21-3326-8021

China - Shenyang

Tel: 86-24-2334-2829
Fax: 86-24-2334-2393

China - Shenzhen

Tel: 86-755-8864-2200
Fax: 86-755-8203-1760

China - Wuhan

Tel: 86-27-5980-5300
Fax: 86-27-5980-5118

China - Xian

Tel: 86-29-8833-7252
Fax: 86-29-8833-7256

ASIA/PACIFIC

China - Xiamen

Tel: 86-592-2388138
Fax: 86-592-2388130

China - Zhuhai

Tel: 86-756-3210040
Fax: 86-756-3210049

India - Bangalore

Tel: 91-80-3090-4444
Fax: 91-80-3090-4123

India - New Delhi

Tel: 91-11-4160-8631
Fax: 91-11-4160-8632

India - Pune

Tel: 91-20-3019-1500

Japan - Osaka

Tel: 81-6-6152-7160
Fax: 81-6-6152-9310

Japan - Tokyo

Tel: 81-3-6880-3770
Fax: 81-3-6880-3771

Korea - Daegu

Tel: 82-53-744-4301
Fax: 82-53-744-4302

Korea - Seoul

Tel: 82-2-554-7200
Fax: 82-2-558-5932 or
82-2-558-5934

Malaysia - Kuala Lumpur

Tel: 60-3-6201-9857
Fax: 60-3-6201-9859

Malaysia - Penang

Tel: 60-4-227-8870
Fax: 60-4-227-4068

Philippines - Manila

Tel: 63-2-634-9065
Fax: 63-2-634-9069

Singapore

Tel: 65-6334-8870
Fax: 65-6334-8850

Taiwan - Hsin Chu

Tel: 886-3-5778-366
Fax: 886-3-5770-955

Taiwan - Kaohsiung

Tel: 886-7-213-7830

Taiwan - Taipei

Tel: 886-2-2508-8600
Fax: 886-2-2508-0102

Thailand - Bangkok

Tel: 66-2-694-1351
Fax: 66-2-694-1350

EUROPE

Austria - Wels

Tel: 43-7242-2244-39
Fax: 43-7242-2244-393

Denmark - Copenhagen

Tel: 45-4450-2828
Fax: 45-4485-2829

Finland - Espoo

Tel: 358-9-4520-820

France - Paris

Tel: 33-1-69-53-63-20
Fax: 33-1-69-30-90-79

France - Saint Cloud

Tel: 33-1-30-60-70-00

Germany - Garching

Tel: 49-8931-9700

Germany - Haan

Tel: 49-2129-3766400

Germany - Heilbronn

Tel: 49-7131-67-3636

Germany - Karlsruhe

Tel: 49-721-625370

Germany - Munich

Tel: 49-89-627-144-0
Fax: 49-89-627-144-44

Germany - Rosenheim

Tel: 49-8031-354-560

Israel - Ra'anana

Tel: 972-9-744-7705

Italy - Milan

Tel: 39-0331-742611
Fax: 39-0331-466781

Italy - Padova

Tel: 39-049-7625286

Netherlands - Drunen

Tel: 31-416-690399
Fax: 31-416-690340

Norway - Trondheim

Tel: 47-7289-7561

Poland - Warsaw

Tel: 48-22-3325737

Romania - Bucharest

Tel: 40-21-407-87-50

Spain - Madrid

Tel: 34-91-708-08-90
Fax: 34-91-708-08-91

Sweden - Gothenberg

Tel: 46-31-704-60-40

Sweden - Stockholm

Tel: 46-8-5090-4654

UK - Wokingham

Tel: 44-118-921-5800
Fax: 44-118-921-5820

Mouser Electronics

Authorized Distributor

Click to View Pricing, Inventory, Delivery & Lifecycle Information:

[Microchip:](#)

[ADM00767](#) [ADM00766](#)