



MICROCHIP

**HV9805
230V_{AC} SEPIC
Evaluation Board
User's Guide**

Note the following details of the code protection feature on Microchip devices:

- Microchip products meet the specification contained in their particular Microchip Data Sheet.
- Microchip believes that its family of products is one of the most secure families of its kind on the market today, when used in the intended manner and under normal conditions.
- There are dishonest and possibly illegal methods used to breach the code protection feature. All of these methods, to our knowledge, require using the Microchip products in a manner outside the operating specifications contained in Microchip's Data Sheets. Most likely, the person doing so is engaged in theft of intellectual property.
- Microchip is willing to work with the customer who is concerned about the integrity of their code.
- Neither Microchip nor any other semiconductor manufacturer can guarantee the security of their code. Code protection does not mean that we are guaranteeing the product as "unbreakable."

Code protection is constantly evolving. We at Microchip are committed to continuously improving the code protection features of our products. Attempts to break Microchip's code protection feature may be a violation of the Digital Millennium Copyright Act. If such acts allow unauthorized access to your software or other copyrighted work, you may have a right to sue for relief under that Act.

Information contained in this publication regarding device applications and the like is provided only for your convenience and may be superseded by updates. It is your responsibility to ensure that your application meets with your specifications. MICROCHIP MAKES NO REPRESENTATIONS OR WARRANTIES OF ANY KIND WHETHER EXPRESS OR IMPLIED, WRITTEN OR ORAL, STATUTORY OR OTHERWISE, RELATED TO THE INFORMATION, INCLUDING BUT NOT LIMITED TO ITS CONDITION, QUALITY, PERFORMANCE, MERCHANTABILITY OR FITNESS FOR PURPOSE. Microchip disclaims all liability arising from this information and its use. Use of Microchip devices in life support and/or safety applications is entirely at the buyer's risk, and the buyer agrees to defend, indemnify and hold harmless Microchip from any and all damages, claims, suits, or expenses resulting from such use. No licenses are conveyed, implicitly or otherwise, under any Microchip intellectual property rights.

Trademarks

The Microchip name and logo, the Microchip logo, dsPIC, FlashFlex, flexPWR, JukeBlox, KEELOQ, KEELOQ logo, Kleer, LANCheck, MediaLB, MOST, MOST logo, MPLAB, OptoLyzer, PIC, PICSTART, PIC³² logo, RightTouch, SpyNIC, SST, SST Logo, SuperFlash and UNI/O are registered trademarks of Microchip Technology Incorporated in the U.S.A. and other countries.

The Embedded Control Solutions Company and mTouch are registered trademarks of Microchip Technology Incorporated in the U.S.A.

Analog-for-the-Digital Age, BodyCom, chipKIT, chipKIT logo, CodeGuard, dsPICDEM, dsPICDEM.net, ECAN, In-Circuit Serial Programming, ICSP, Inter-Chip Connectivity, KleerNet, KleerNet logo, MiWi, MPASM, MPF, MPLAB Certified logo, MPLIB, MPLINK, MultiTRAK, NetDetach, Omniscient Code Generation, PICDEM, PICDEM.net, PICkit, PICtail, RightTouch logo, REAL ICE, SQI, Serial Quad I/O, Total Endurance, TSHARC, USBCheck, VariSense, ViewSpan, WiperLock, Wireless DNA, and ZENA are trademarks of Microchip Technology Incorporated in the U.S.A. and other countries.

SQTP is a service mark of Microchip Technology Incorporated in the U.S.A.

Silicon Storage Technology is a registered trademark of Microchip Technology Inc. in other countries.

GestIC is a registered trademarks of Microchip Technology Germany II GmbH & Co. KG, a subsidiary of Microchip Technology Inc., in other countries.

All other trademarks mentioned herein are property of their respective companies.

© 2015, Microchip Technology Incorporated, Printed in the U.S.A., All Rights Reserved.

ISBN: 978-1-63277-336-4

QUALITY MANAGEMENT SYSTEM
CERTIFIED BY DNV
== ISO/TS 16949 ==

Microchip received ISO/TS-16949:2009 certification for its worldwide headquarters, design and wafer fabrication facilities in Chandler and Tempe, Arizona; Gresham, Oregon and design centers in California and India. The Company's quality system processes and procedures are for its PIC[®] MCUs and dsPIC[®] DSCs, KEELOQ[®] code hopping devices, Serial EEPROMs, microperipherals, nonvolatile memory and analog products. In addition, Microchip's quality system for the design and manufacture of development systems is ISO 9001:2000 certified.

Object of Declaration: HV9805 230V_{AC} SEPIC Evaluation Board

EU Declaration of Conformity

Manufacturer: Microchip Technology Inc.
2355 W. Chandler Blvd.
Chandler, Arizona, 85224-6199
USA

This declaration of conformity is issued by the manufacturer.

The development/evaluation tool is designed to be used for research and development in a laboratory environment. This development/evaluation tool is not a Finished Appliance, nor is it intended for incorporation into Finished Appliances that are made commercially available as single functional units to end users under EU EMC Directive 2004/108/EC and as supported by the European Commission's Guide for the EMC Directive 2004/108/EC (8th February 2010).

This development/evaluation tool complies with EU RoHS2 Directive 2011/65/EU.

This development/evaluation tool, when incorporating wireless and radio-telecom functionality, is in compliance with the essential requirement and other relevant provisions of the R&TTE Directive 1999/5/EC and the FCC rules as stated in the declaration of conformity provided in the module datasheet and the module product page available at www.microchip.com.

For information regarding the exclusive, limited warranties applicable to Microchip products, please see Microchip's standard terms and conditions of sale, which are printed on our sales documentation and available at www.microchip.com.

Signed for and on behalf of Microchip Technology Inc. at Chandler, Arizona, USA

Derek Carlson
VP Development Tools

12-Sep-14
Date

NOTES:

Table of Contents

Preface	7
Introduction.....	7
Document Layout	7
Conventions Used in this Guide	8
Recommended Reading.....	9
The Microchip Web Site	9
Customer Support	9
Revision History	9
Chapter 1. Product Overview	
1.1 Introduction	11
1.2 Specifications	11
1.3 Device Summary	11
1.4 What Does the HV9805 230V _{AC} SEPIC Evaluation Board Include?	12
Chapter 2. Installation and Operation	
2.1 Safety Caution	13
2.2 Getting Started	13
2.2.1 Additional Tools Required or Desirable for Evaluation	13
2.3 Setup Procedure	14
2.3.1 AC Input Considerations	14
2.3.2 LED Load Considerations	14
2.4 Evaluating the Application	14
Appendix A. Schematic and Layouts	
A.1 Introduction	15
A.2 Board – Schematic	16
A.3 Board – Top Silk Screen, Paste Mask, Copper Pads	17
A.4 Board – Top Assembly, Copper Pads	17
A.5 Board – Top Copper, Paste Mask	17
A.6 Board – Bottom Silk Screen, Paste Mask, Copper Pads	18
A.7 Board – Bottom Assembly, Copper Pads	18
A.8 Board – Bottom Copper, Paste Mask	18
Appendix B. Bill of Materials (BOM)	
Appendix C. Performance Data	
C.1 Performance Data versus AC Line Voltage	21
C.2 Performance Graphs	21
C.2.1 Efficiency Vs. Line Voltage	21
C.2.2 Total Harmonic Distortion Vs. Line Voltage	22

C.2.3 Power Factor Vs. Line Voltage	22
---	----

Appendix D. Test Points and Waveforms

D.1 Test Points Description	24
D.2 Waveform Examples	24
D.2.1 Line Current, LED Current	24
D.2.2 BUS, BVS	27
D.2.3 DRN, CAP	27
D.2.4 DRN, REC	28
D.2.5 DRN, DRV	29
D.2.6 Inductor Currents	32
D.2.7 BUS, REG, HVS, CRG, CRS	34
D.2.8 HVR	36
D.2.9 CSH	37
D.2.10 VDD	39

Appendix E. EMI

E.1 CISPR15 Conducted Emissions	41
E.1.1 Line	41
E.1.2 Neutral	41

Worldwide Sales and Service	42
--	-----------

Preface

NOTICE TO CUSTOMERS

All documentation becomes dated, and this manual is no exception. Microchip tools and documentation are constantly evolving to meet customer needs, so some actual dialogs and/or tool descriptions may differ from those in this document. Please refer to our web site (www.microchip.com) to obtain the latest documentation available.

Documents are identified with a “DS” number. This number is located on the bottom of each page, in front of the page number. The numbering convention for the DS number is “DSXXXXXXXXA”, where “XXXXXXXX” is the document number and “A” is the revision level of the document.

For the most up-to-date information on development tools, see the MPLAB® IDE online help. Select the Help menu, and then Topics to open a list of available online help files.

INTRODUCTION

This chapter contains general information that will be useful to know before using the HV9805 230V_{AC} SEPIC Evaluation Board. Items discussed in this chapter include:

- Document Layout
- Conventions Used in this Guide
- Recommended Reading
- The Microchip Web Site
- Customer Support
- Revision History

DOCUMENT LAYOUT

This document describes how to use the HV9805 230V_{AC} SEPIC Evaluation Board. The document is organized as follows:

- **Chapter 1. “Product Overview”** – Includes general information about the HV9805 230V_{AC} SEPIC Evaluation Board.
- **Chapter 2. “Installation and Operation”** – Includes instructions for connecting and using the board.
- **Appendix A. “Schematic and Layouts”** – Shows the schematic and layout diagrams for the HV9805 230V_{AC} SEPIC Evaluation Board.
- **Appendix B. “Bill of Materials (BOM)”** – Lists the parts used to build the HV9805 230V_{AC} SEPIC Evaluation Board.
- **Appendix C. “Performance Data”** – Includes performance data on the HV9805 230V_{AC} SEPIC Evaluation Board by way of tables and graphs.
- **Appendix D. “Test Points and Waveforms”** – Describes test points and waveforms for the HV9805 230V_{AC} SEPIC Evaluation Board.
- **Appendix E. “Electromagnetic Interference”** – Includes conducted EMI measurements of the HV9805 230V_{AC} SEPIC Evaluation Board.

CONVENTIONS USED IN THIS GUIDE

This manual uses the following documentation conventions:

DOCUMENTATION CONVENTIONS

Description	Represents	Examples
Arial font:		
Italic characters	Referenced books	<i>MPLAB[®] IDE User's Guide</i>
	Emphasized text	...is the <i>only</i> compiler...
Initial caps	A window	the Output window
	A dialog	the Settings dialog
	A menu selection	select Enable Programmer
Quotes	A field name in a window or dialog	"Save project before build"
Underlined, italic text with right angle bracket	A menu path	<u><i>File>Save</i></u>
Bold characters	A dialog button	Click OK
	A tab	Click the Power tab
N'Rnnnn	A number in verilog format, where N is the total number of digits, R is the radix and n is a digit.	4'b0010, 2'hF1
Text in angle brackets < >	A key on the keyboard	Press <Enter>, <F1>
Courier New font:		
Plain Courier New	Sample source code	#define START
	Filenames	autoexec.bat
	File paths	c:\mcc18\h
	Keywords	_asm, _endasm, static
	Command-line options	-Opa+, -Opa-
	Bit values	0, 1
	Constants	0xFF, 'A'
Italic Courier New	A variable argument	<i>file.o</i> , where <i>file</i> can be any valid filename
Square brackets []	Optional arguments	mcc18 [options] <i>file</i> [options]
Curly brackets and pipe character: { }	Choice of mutually exclusive arguments; an OR selection	errorlevel {0 1}
Ellipses...	Replaces repeated text	var_name [, var_name...]
	Represents code supplied by user	void main (void) { ... }

RECOMMENDED READING

This user's guide describes how to use the HV9805 230V_{AC} SEPIC Evaluation Board. Other useful documents are listed below. The following Microchip document is available and recommended as a supplemental reference resource.

- **HV9805 Data Sheet – “Off-Line LED Driver with True DC Output Current” (DS20005374).**

THE MICROCHIP WEB SITE

Microchip provides online support via our web site at www.microchip.com. This web site is used as a means to make files and information easily available to customers. Accessible by using your favorite Internet browser, the web site contains the following information:

- **Product Support** – Data sheets and errata, application notes and sample programs, design resources, user's guides and hardware support documents, latest software releases and archived software
- **General Technical Support** – Frequently Asked Questions (FAQs), technical support requests, online discussion groups, Microchip consultant program member listing
- **Business of Microchip** – Product selector and ordering guides, latest Microchip press releases, listing of seminars and events, listings of Microchip sales offices, distributors and factory representatives

CUSTOMER SUPPORT

Users of Microchip products can receive assistance through several channels:

- Distributor or Representative
- Local Sales Office
- Field Application Engineer (FAE)
- Technical Support

Customers should contact their distributor, representative or field application engineer (FAE) for support. Local sales offices are also available to help customers. A listing of sales offices and locations is included in the back of this document.

Technical support is available through the web site at:

<http://www.microchip.com/support>.

REVISION HISTORY

Revision A (April 2015)

- This is the initial release of this document.

NOTES:

Chapter 1. Product Overview

1.1 INTRODUCTION

The HV9805 230V_{AC} SEPIC Evaluation Board is suited for driving a 125V/100 mA LED load from a 230V_{AC} source.

The single-ended primary-inductor converter (SEPIC) configuration extends the application range of the HV9805 driver Integrated Circuit (IC) to lower LED load voltages than otherwise possible with the boost configuration. Many features of the boost configuration are retained, such as a true direct current drive of the LED load, high input power factor, high efficiency and simple magnetics.

The SEPIC configuration can be used to advantage with any of the common AC voltage levels, such as 100V_{AC}, 120V_{AC}, 230V_{AC}, 277V_{AC} and 24V_{AC}.

Note that the boost topology can process more power than the SEPIC topology for a given current rating of the converter switch. Whereas the switch of the boost topology carries the line current only during on-time of the switch, the switch of the SEPIC topology carries both the line current (inductor current L51) and the load current (inductor current L50) during on-time of the switch. Accordingly, the power handling capability of the SEPIC converter is lower than the boost converter for a given current rating of the switch. It is also worth noting that the SEPIC power rating drops with output voltage, since a lower output voltage translates into a larger load current and thereby a larger switch current.

1.2 BOARD FEATURES

The HV9805 230V_{AC} SEPIC Evaluation Board has the following features:

- AC Line Voltage: 230 V_{RMS} (± 15%)
- DC Load Voltage: 125 V_{DC}
- DC Load Current: 100 mA_{DC}
- Output Power: 12.5W
- Power Factor (PF): 98.9%
- Total Harmonic Distortion (THD): 9.6%
- Efficiency: 86.9%
- Output overvoltage protection: Yes
- Electromagnetic Interference (EMI): Satisfies CISPR 15 limits
- THD: Satisfies EN 61000-3-2 Class C limits
- Board Dimensions: 6.400 x 2.000 inches

1.3 HV9805 DEVICE SUMMARY

The evaluation board features the HV9805 LED driver IC. The HV9805 device is described in the HV9805 Data Sheet – “Off-Line LED Driver with True DC Output Current” (DS20005374).

The standard HV9805 application circuit supplies a true DC current to the LED load by using a converter for AC to DC power conversion, and a linear post regulator for constant current regulation of the LED load current. By nature of the boost converter, the LED load voltage should be higher than the peak AC line voltage.

A lower LED load voltage can be accommodated by the use of a SEPIC converter. The SEPIC provides a solution where the LED load voltage is either higher or lower than the peak AC line voltage; as the SEPIC converter is capable of bucking and boosting the input voltage.

1.4 NOTES ON THE EVALUATION BOARD DESIGN

1.4.1 Surge Protection and Voltage Withstand Capability

The evaluation board demonstrates the basic functionality of the HV9805 in a SEPIC configuration. No special effort was made to include measures for transient overvoltage protection. Such protection typically involves the addition of at least one stage of metal-oxide varistor (MOV) protection and the coordination of the voltage withstand capability of components exposed to line voltage transients.

1.4.2 LED Current Regulator Oscillation

The first-released evaluation board exhibits high-frequency oscillation of the drain voltage of pass transistor M2. This oscillation does not affect the functionality of the board significantly.

The drain voltage oscillation can be suppressed by including 100 k Ω in series with the gate lead of pass transistor M2.

The traces relating to the headroom voltage (test points REG and HVS), as shown in [Appendix D](#), were captured with the suppression resistor in place.

1.4.3 Harmonic Distortion

Harmonic distortion can be lowered by increasing the capacitance of the compensation capacitor C4.

1.5 WHAT DOES THE HV9805 230V_{AC} SEPIC EVALUATION BOARD INCLUDE?

The HV9805 230V_{AC} SEPIC Evaluation Board includes:

- HV9805 230V_{AC} SEPIC Evaluation Board (ADM00656)
- Information Sheet

Chapter 2. Installation and Operation

2.1 SAFETY CAUTION

WARNING

Working with this board can cause serious bodily harm or death. Connecting the board to a source of line voltage will result in the presence of hazardous voltage throughout the system including the LED load and any attached instrumentation. The board should only be handled by persons well aware of the dangers involved with working on live electrical equipment.

Extreme care should be taken to protect against electric shock. Disconnect the board before attempting to make any changes to the system configuration. Always work with another person nearby who can offer assistance in case of an emergency.

Wear safety glasses for eye protection.

NOTICE

The electrolytic capacitor C50 carries a hazardous voltage for an extended time after shutdown of the LED driver board. Capacitor C50 will slowly discharge by way of resistors R18 and R19, as well as test point W3, the LED load, test point W4 and resistors R15 and R11, or at a faster rate if a resistor is purposely added across the terminals of capacitor C50. Check the capacitor voltage before handling the board. Observe polarity for all steps to prevent board damage.

2.2 GETTING STARTED

The HV9805 230V_{AC} SEPIC Evaluation Board is fully assembled and tested. The board requires the use of an external AC source (230V_{AC}) and an external LED load (125V_{DC}, 100 mA_{DC}).

The board features metal loop-style test points for making connections to the AC line and the LED load and test vias for probing certain circuit nodes.

2.2.1 Additional Tools Required or Desirable for Evaluation

A list of additional tools that are required or may be used during evaluation include:

- DC and AC voltage and current meters
- A power analyzer for measuring the AC power and the AC power factor
- An oscilloscope for characterizing waveforms
- A variable transformer for adjusting the AC line voltage
- An isolation transformer (if an oscilloscope is attached to board circuitry)

2.3 SETUP PROCEDURE

To operate the HV9805 230V_{AC} SEPIC Evaluation Board, the following steps must be completed:

1. Attach the LED load to the output test points W3 and W4, labeled as POS and NEG on the board. Observe the polarity of connections. Connect the anode of the LED load to test point W3 (POS) and the cathode to test point W4 (NEG).
2. Connect the AC source to the input test points W1 and W2. Both terminals are also marked as 'AC'.

2.3.1 AC Input Considerations

The AC voltage can either be applied in full or be brought up gradually with a variable transformer.

The external circuit for the HV9805's BVS pin has been adapted to the SEPIC topology, offering protection against line undervoltage and against output overvoltage or an open load condition.

The undervoltage lockout circuit (R12, R13, R14, C6, D1) disables the driver when the line voltage is less than approximately 200V_{AC} when the bus voltage is zero. The threshold changes to a lower value when a non-zero bus voltage is present. A non-zero bus voltage can be the result of driver operation prior to a shutdown event, or can be caused by a gradual build-up when the line voltage is gradually increased by a variable transformer. A more sophisticated circuit is required if the undervoltage threshold dependency on bus voltage is undesirable.

The overvoltage protection circuit disables the driver when the output voltage rises above 150V_{DC}. The output overvoltage protection is non-latching, meaning that the driver will cyclically turn on and off when an LED load overvoltage condition or an output open circuit condition is present.

2.3.2 LED Load Considerations

The driver is designed for a load voltage of 125V_{DC} and a load current of 100 mA_{DC}. The load current is fixed and set by the resistors R17 and R20.

The board can be operated with substantially lower LED voltage. Operation at lower LED voltage results in loss of efficiency, lower power factor and higher harmonic distortion, as shown in [Table 2-1](#).

TABLE 2-1:

Test	V _{LED}	I _{LED}	P _{LED}	V _{AC}	I _{AC}	P _{AC}	EFF	THD	PF
#	V _{DC}	mA _{DC}	W	V _{RMS}	mA _{RMS}	W	%	%	%
1	124.5	104.0	12.93	230.3	63.7	14.62	88.5	6.33	99.6
2	113.6	104.0	11.81	230.3	58.4	13.39	88.2	7.34	99.5
3	102.8	104.0	10.69	230.3	53.3	12.19	87.7	8.76	99.4
4	92.4	104.0	9.61	230.3	48.4	11.05	87.0	10.7	99.1
5	81.4	104.0	8.47	230.3	43.2	9.83	86.1	13.3	98.8
6	70.5	103.9	7.32	230.3	38.1	8.62	85.0	16.7	98.2
7	59.6	103.9	6.19	230.3	33.1	7.42	83.4	21.2	97.2

2.4 EVALUATING THE APPLICATION

Typical voltage and waveforms are provided in [Appendix D. "Test Points and Waveforms"](#).



HV9805 230V_{AC} SEPIC EVALUATION BOARD USER'S GUIDE

Appendix A. Schematic and Layouts

A.1 INTRODUCTION

This appendix contains the following schematics and layouts for the HV9805 230V_{AC} SEPIC Evaluation Board:

- Board – Schematic
- Board – Top Silk Screen, Paste Mask, Copper Pads
- Board – Top Assembly, Copper Pads
- Board – Top Copper, Copper Pads
- Board – Bottom Silk Screen, Paste Mask, Copper Pads
- Board – Bottom Assembly, Copper Pads
- Board – Bottom Copper, Copper Pads

HV9805 230V_{AC} SEPIC Evaluation Board User's Guide

A.2 BOARD – SCHEMATIC

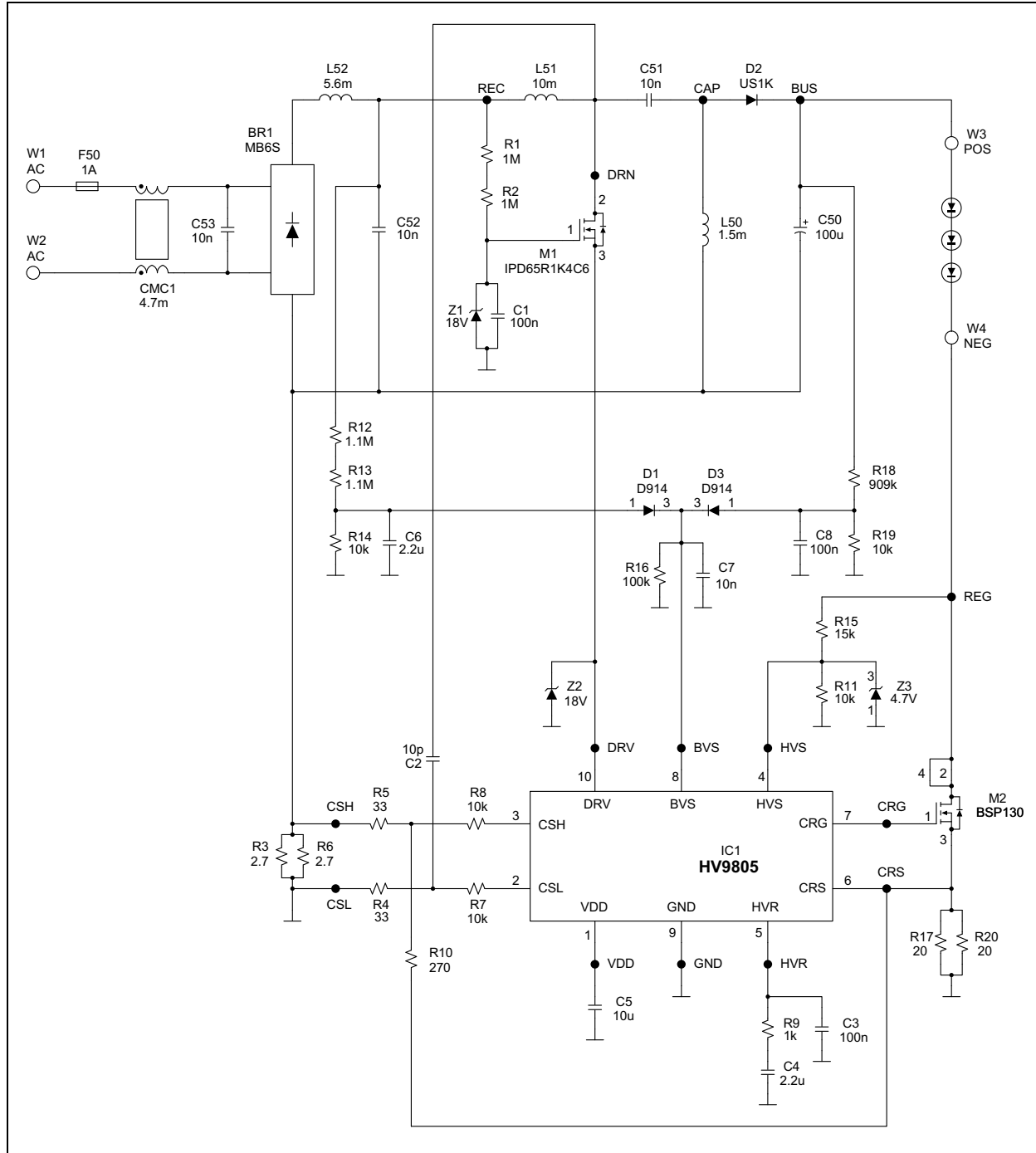

A.3 BOARD – TOP SILK SCREEN, PASTE MASK, COPPER PADS

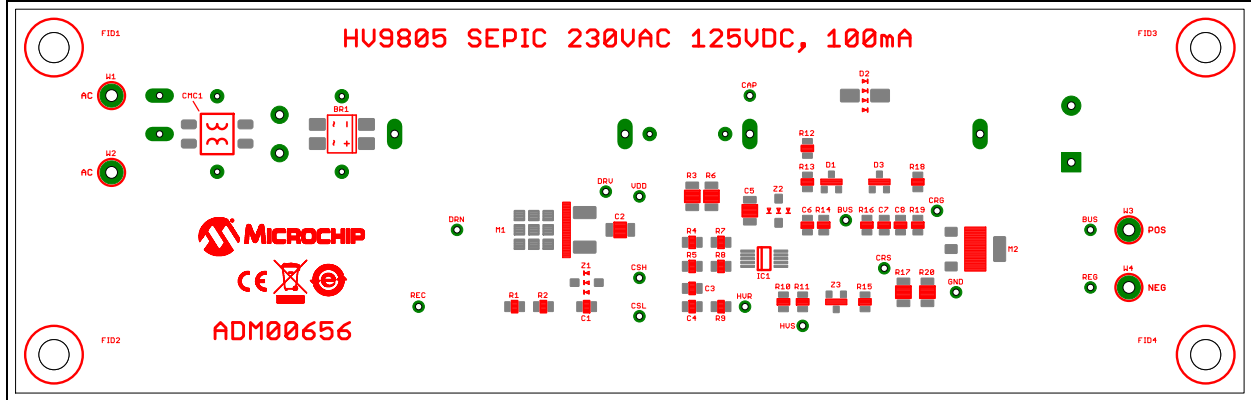

A.4 BOARD – TOP ASSEMBLY, COPPER PADS

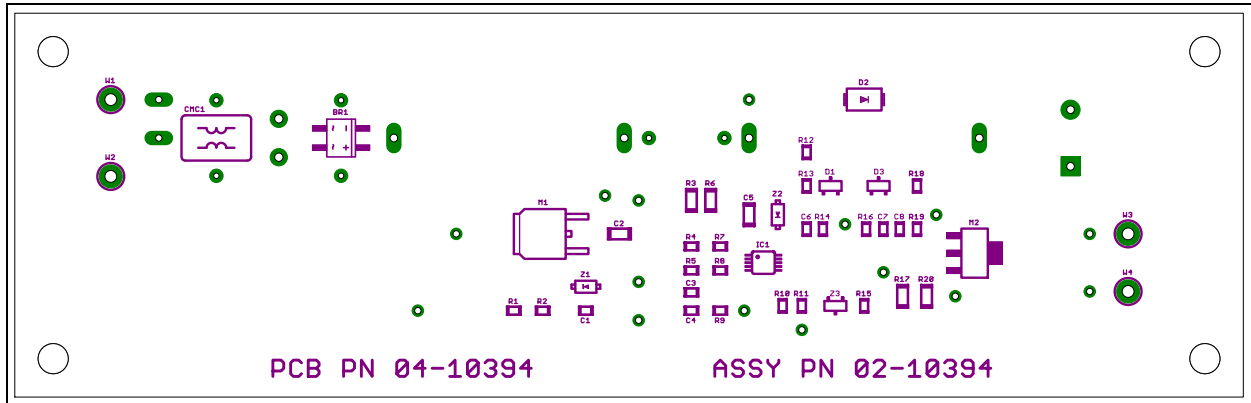

A.5 BOARD – TOP COPPER, COPPER PADS

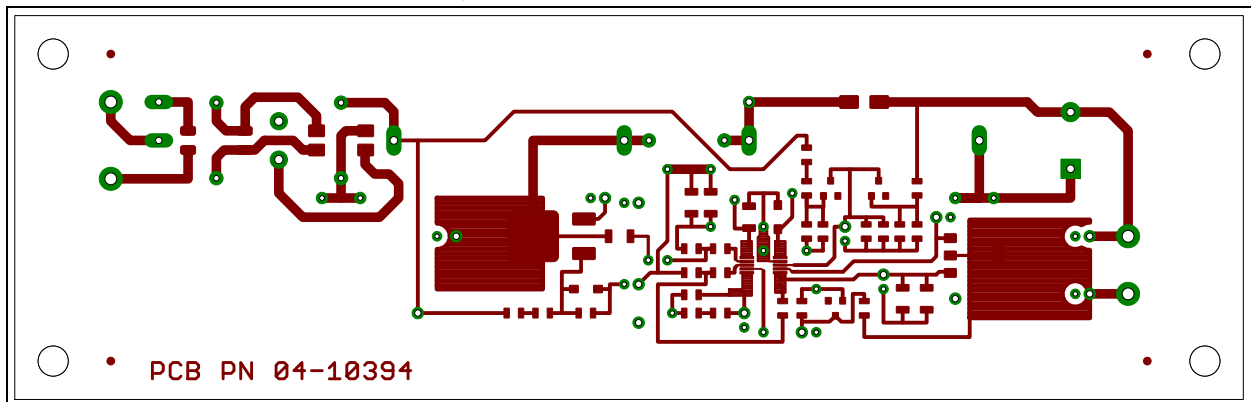

A.6 BOARD – BOTTOM SILK SCREEN, PASTE MASK, COPPER PADS

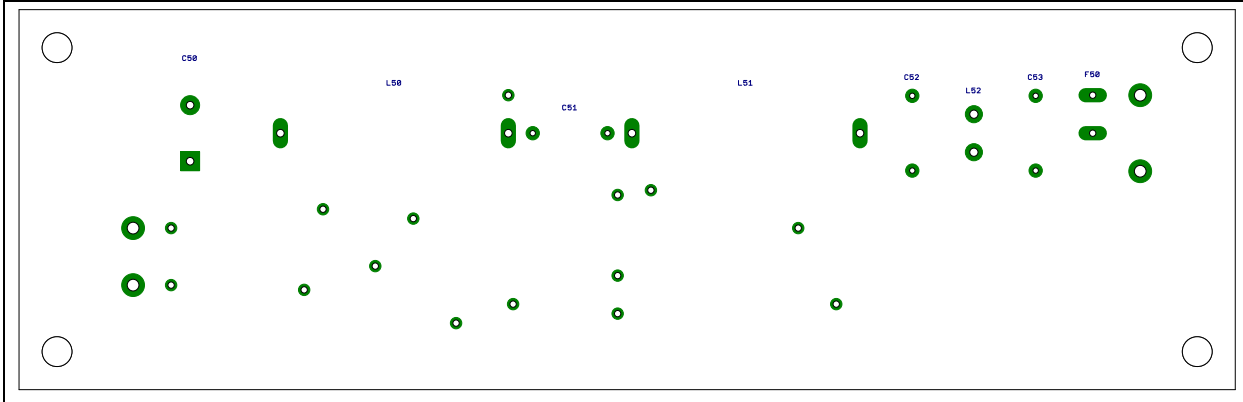

A.7 BOARD – BOTTOM ASSEMBLY, COPPER PADS

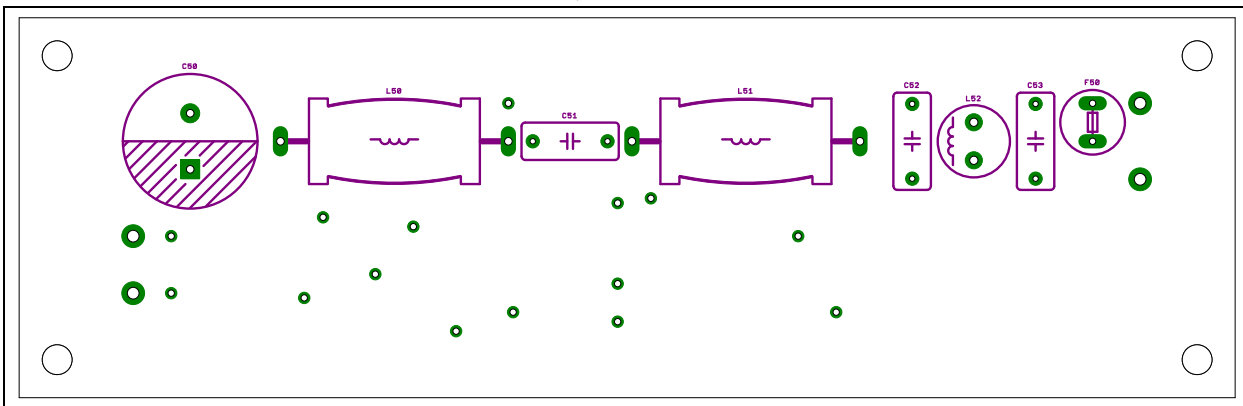

A.8 BOARD – BOTTOM COPPER, COPPER PADS

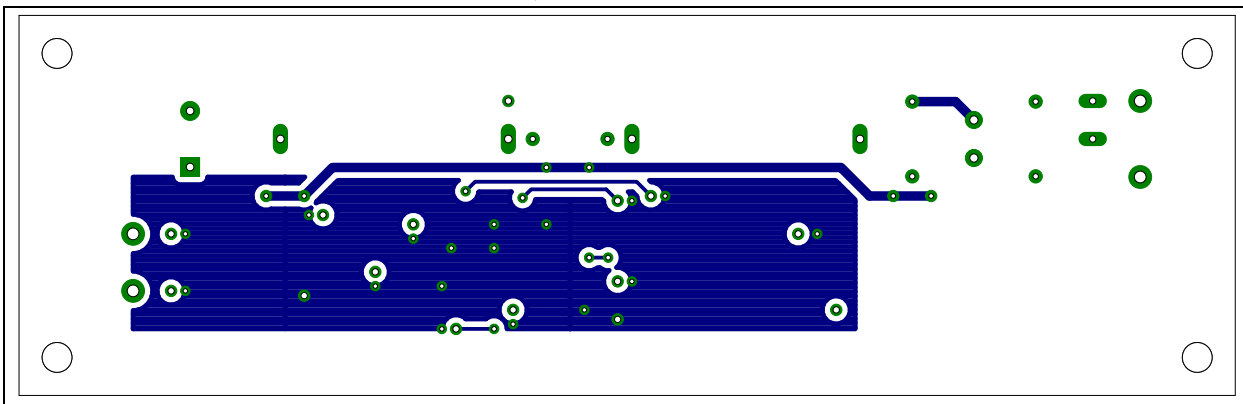

Appendix B. Bill of Materials (BOM)

TABLE B-1: BILL OF MATERIALS (BOM)

Qty.	Reference	Description	Manufacturer	Part Number
1	BR1	Diode Bridge 600V 0.5A MBS	Fairchild Semiconductor®	MB6S
3	C1, C3, C8	Capacitor Ceramic X7R 10% 50V _{DC} 0805 100 nF	Yageo Corporation	CC0805KRX7R9BB104
1	C2	Capacitor Ceramic C0G 5% 1000V _{DC} 1206 10 pF	Kemet®	CL31C100JIFNNNE
2	C4, C6	Capacitor Ceramic X7R 10% 16V _{DC} 0805 2.2 μF	TDK Corporation	C2012X7R1C225K125AB
1	C5	Capacitor Ceramic X7R 10% 25V _{DC} 1206 10 μF	Samsung Electro-Mechan- ics America, Inc.	CL31B106KAHNFNE
1	C7	Capacitor Ceramic X7R 10% 50V _{DC} 0805 10 nF	Yageo Corporation	CC0805KRX7R9BB103
1	C50	Capacitor Electrolytic 105C 20% 100 μF 200V	Nichicon Corporation	UCS2D101MHD
3	C51, C52, C53	Capacitor Film 630V _{DC} 20% 10 nF	EPCOS AG	B32521N8103M
1	CMC1	Common Mode Line Filter 4.7 mH	Würth Elektronik	744220
2	D1, D3	Diode Switching 75V 200 MA SOT23	Diodes® Incorporated	MMBD914-7-F
1	D2	Diode Ultra-Fast 800V 1A SMA	Diodes Incorporated	US1K-13-F
1	F50	1A Radial Ledged T Fuse, 300V _{AC}	Littelfuse®	38311000000
1	IC1	IC LED Driver MSOP-10L HV9805	Microchip Technology Inc.	HV9805MG-G
1	L50	Inductor 1.5 mH 600 mA Axial	Bourns®, Inc.	5900-152-RC
1	L51	Inductor 10 mH 250 mA Axial	Bourns, Inc.	5900-103-RC
1	L52	Inductor Radial 5.6 mH	Würth Elektronik	744731562
1	M1	MOSFET N-Ch. 650V 8.3A DPAK	Infineon Technologies AG	IPD65R1K4C6
1	M2	MOSFET N-Ch. 300V 350 mA SC73	NXP Semiconductors	BSP130, 115
1	PCB	HV9805 230V _{AC} SEPIC Eval- uation Board – Printed Circuit Board	Microchip Technology Inc.	04-10394
2	R1, R2	Resistor ThkF, 1/8W 100 ppmC 5% 0805 1MΩ	Panasonic® – ECG	ERJ-6ENF1004V
2	R3, R6	Resistor ThkF, 1/4W 100 ppmC 1% 1206 2.7Ω	Yageo Corporation	RC1206FR-072R7L
2	R4, R5	Resistor ThkF, 1/8W 100 ppmC 1% 0805 33Ω	Yageo Corporation	RC0805FR-0733RL

Note: The components listed in this Bill of Materials are representative of the PCB assembly. The released BOM used in manufacturing uses all RoHS-compliant components.

Bill of Materials (BOM)

TABLE B-1: BILL OF MATERIALS (BOM) (CONTINUED)

Qty.	Reference	Description	Manufacturer	Part Number
5	R7, R8, R11, R14, R19	Resistor ThkF, 1/8W 100 ppmC 1% 0805 10k Ω	Yageo Corporation	RC0805FR-0710KL
1	R9	Resistor ThkF, 1/8W 100 ppmC 1% 0805 1k Ω	Panasonic – ECG	ERJ-6ENF1001V
1	R10	Resistor ThkF, 1/8W 100 ppmC 1% 0805 270 Ω	Panasonic – ECG	ERJ-6ENF2700V
2	R12, R13	Resistor ThkF, 1/8W 100 ppmC 5% 0805 1.1M Ω	Panasonic – ECG	ERJ-6ENF1104V
1	R15	Resistor ThkF, 1/8W 100 ppmC 1% 0805 15k Ω	Panasonic – ECG	ERJ-6ENF1502V
1	R16	Resistor ThkF, 1/8W 100 ppmC 1% 0805 100k Ω	Yageo Corporation	RC0805FR-07100KL
2	R17, R20	Resistor ThkF, 1/4W 100 ppmC 1% 1206 20 Ω	Yageo Corporation	RC1206FR-0720RL
1	R18	Resistor ThkF, 1/8W 100 ppmC 1% 0805 909 k Ω	Panasonic – ECG	ERJ-6ENF9093V
4	W1, W2, W3, W4	Test Point multi-purpose white	Keystone Electronics Corp.	5012
2	Z1, Z2	Diode Zener, 18V 500MW SOD123	Diodes Incorporated	DDZ18C-7
1	Z3	Diode Zener, 4.7V 350MW SOT23	Diodes Incorporated	BZX84C4V7-7-F

Note: The components listed in this Bill of Materials are representative of the PCB assembly. The released BOM used in manufacturing uses all RoHS-compliant components.

Appendix C. Performance Data

C.1 PERFORMANCE DATA VERSUS AC LINE VOLTAGE

The following performance data was gathered with a representative sample of the evaluation board connected to a 125V/100 mA LED load. The performance graphs are a graphical representation of the measurement data of [Table C-1](#).

TABLE C-1: PERFORMANCE DATA

V _{AC} (V _{RMS})	I _{AC} (mA _{RMS})	P _{AC} (W)	THD (%)	PF (%)	V _{LED} (V _{DC})	I _{LED} (mA _{DC})	P _{LED} (W)	EFF (%)
190.9	77.0	14.63	6.0	99.5	123.7	103.3	12.78	87.3
210.6	70.0	14.65	7.3	99.3	123.7	103.3	12.77	87.2
230.7	64.4	14.69	9.6	98.9	123.6	103.3	12.77	86.9
250.6	59.8	14.74	12.5	98.4	123.6	103.2	12.76	86.6
270.3	56.0	14.81	15.8	97.7	123.6	103.2	12.76	86.1

C.2 PERFORMANCE GRAPHS

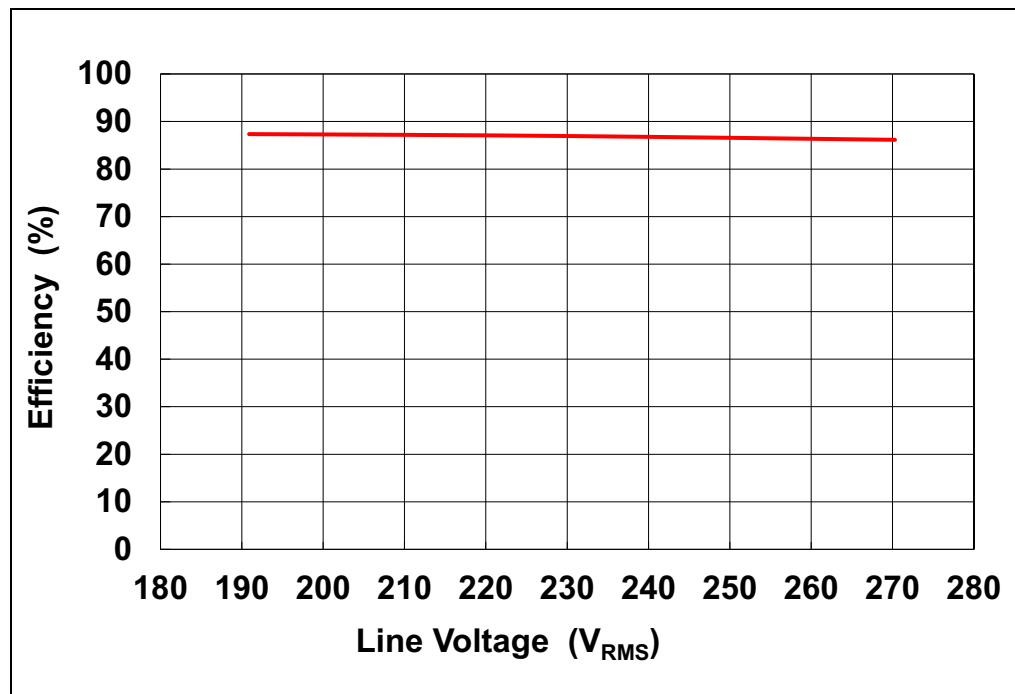

FIGURE C-1: Efficiency vs. Line Voltage.

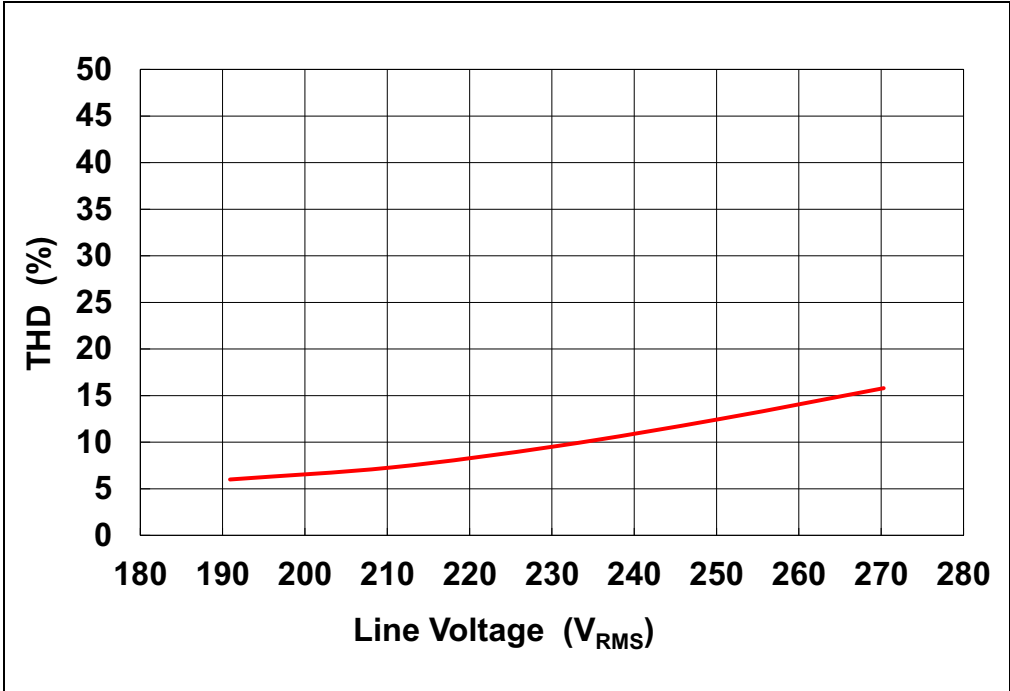

FIGURE C-2: Total Harmonic Distortion vs. Line Voltage.

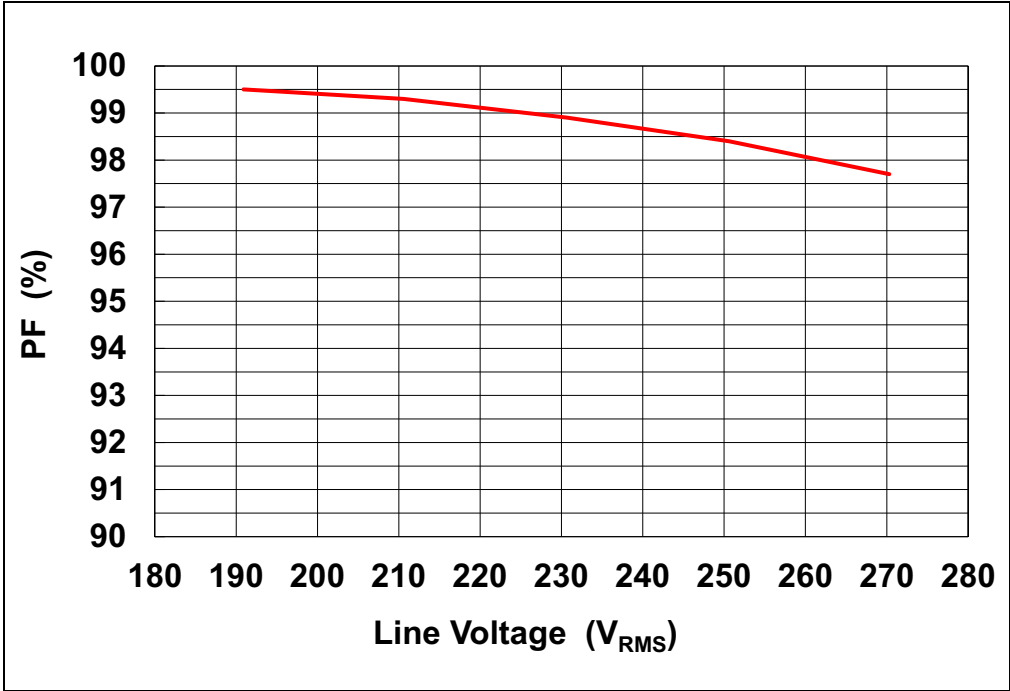

FIGURE C-3: Power Factor vs. Line Voltage.

NOTES:

Appendix D. Test Points and Waveforms

D.1 TEST POINTS DESCRIPTION

TABLE D-1: TEST POINTS

Name	Description
BUS	Power stage, bus capacitor, output voltage
BVS	Control IC input, bus capacitor, output sense voltage
CAP	Power stage, second switching node, switching voltage
CRG	Control IC output, constant current regulator, gate control voltage
CRS	Control IC input, constant current regulator, LED current sense voltage
CSH	Control IC input, current sense resistor voltage, high side
CSL	Control IC input, current sense resistor voltage, low side
DRN	Power stage, external FET, drain voltage
DRV	Control IC output, external FET control voltage
GND	Ground
HVR	Control IC output, headroom voltage regulator, amplifier output voltage
HVS	Control IC input, headroom voltage regulator, headroom sense voltage
REC	Power stage, rectified line voltage
REG	Power stage, constant current regulator, headroom voltage
VDD	V _{DD} supply voltage

Note: The naming of test points on this board does not follow the TP1, TP2 format. Test points on the board are identified by the names as given in [Table D-1](#).

D.2 WAVEFORM EXAMPLES

The voltage waveforms in the following oscillograms are marked with the name of the corresponding test points. Current waveforms were taken with a DC current probe.

Line current was measured by attaching the probe to an AC input lead and the LED current was measured by attaching the probe to an output lead. The inductor currents L50 and L51 were measured by inserting temporary leads in series with the inductors and attaching the probe to the temporary leads.

D.2.1 Line Current, LED Current

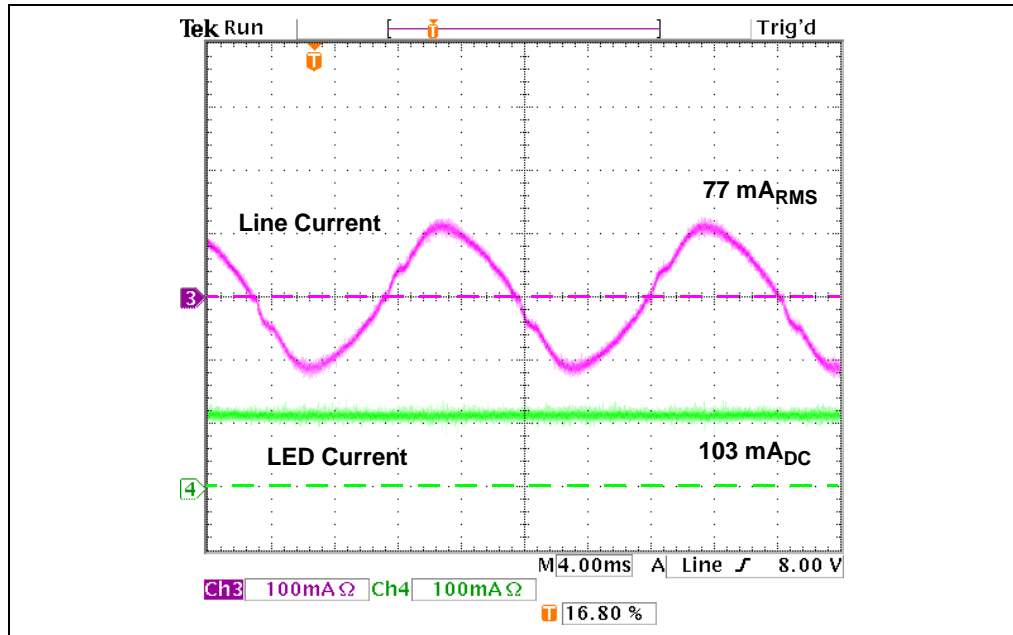

FIGURE D-1: AC Input Voltage at 190V_{AC}.

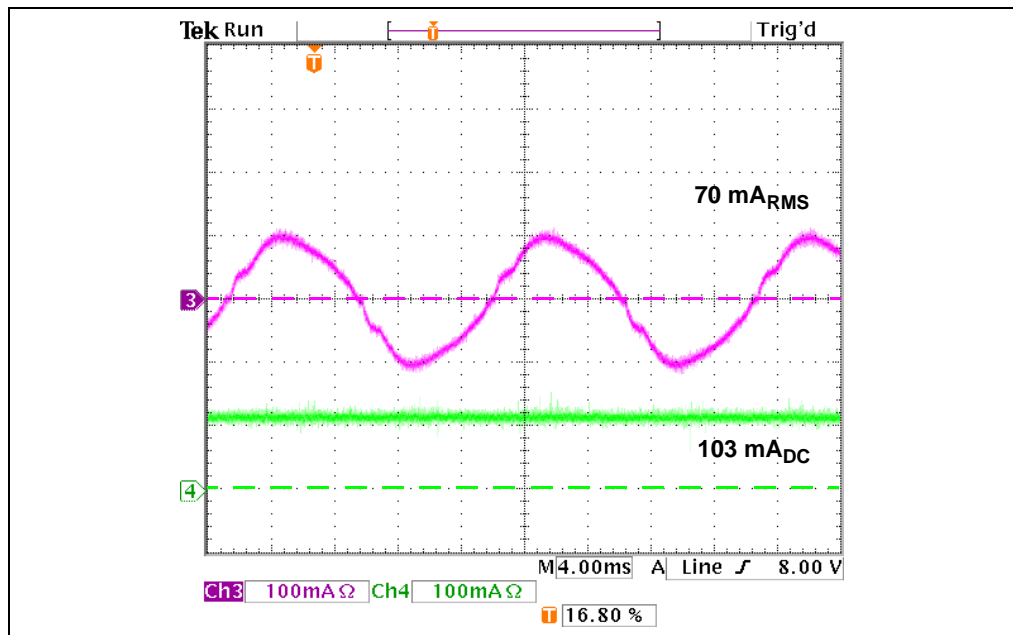

FIGURE D-2: AC Input Voltage at 210V_{AC}.

Test Points and Waveforms

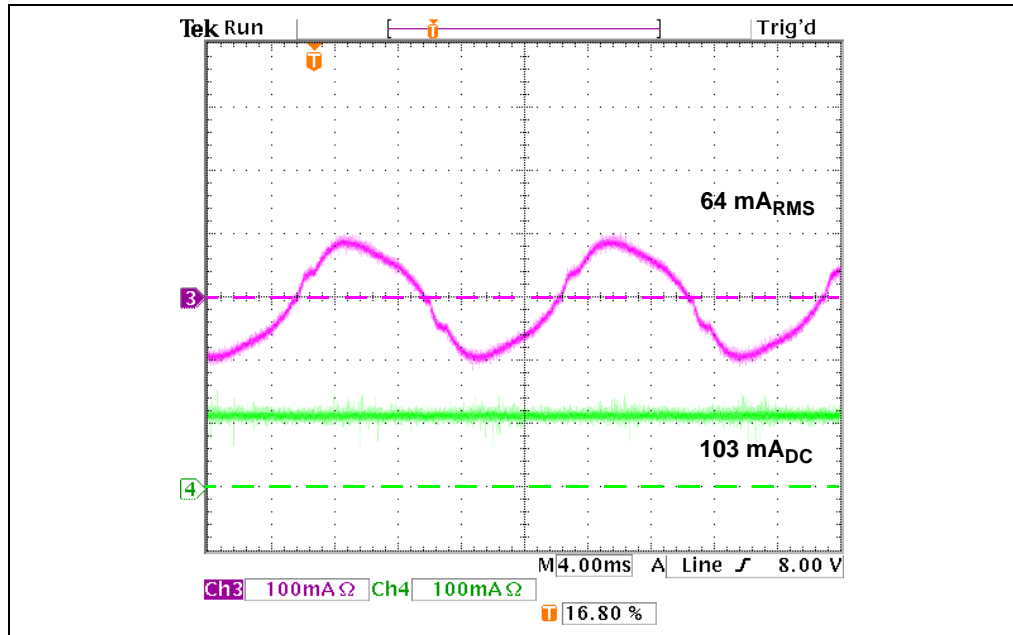

FIGURE D-3: AC Input Voltage at 230V_{AC}.

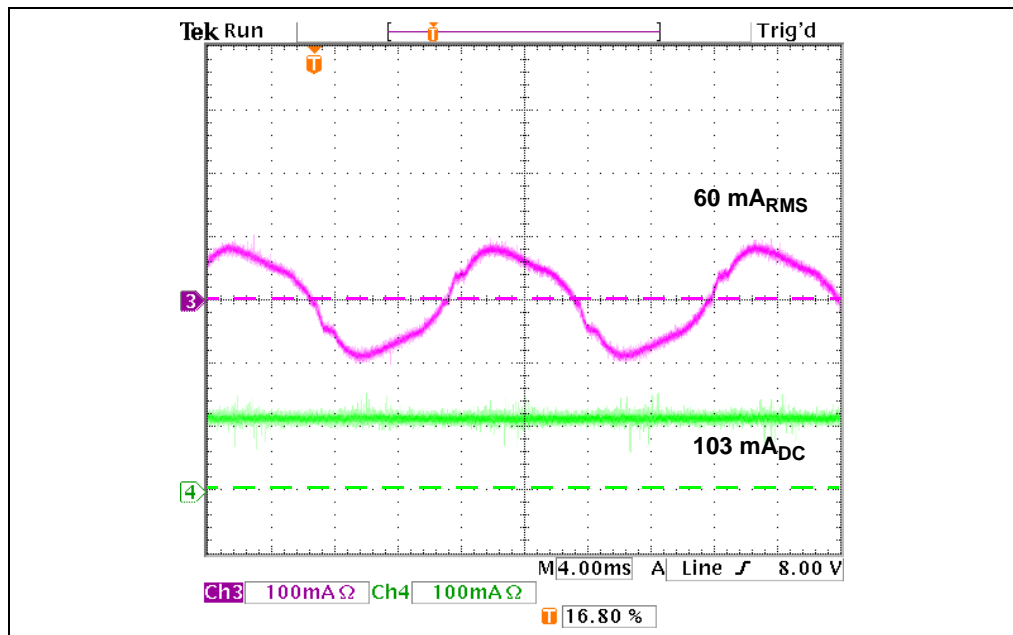

FIGURE D-4: AC Input Voltage at 250V_{AC}.

Test Points and Waveforms

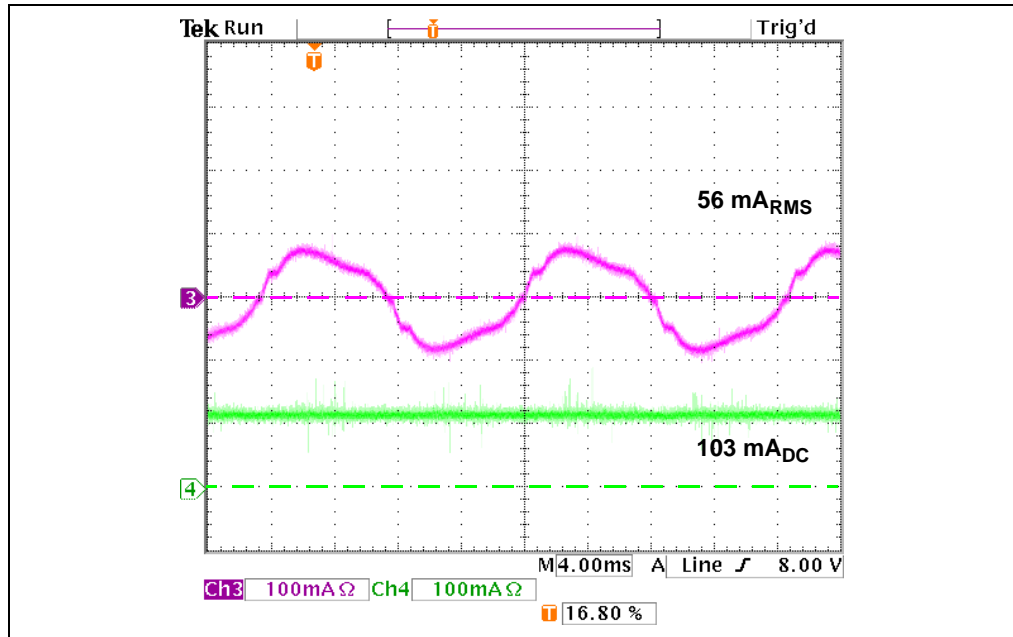

FIGURE D-5: AC Input Voltage at 270V_{AC}.

Test Points and Waveforms

D.2.2 BUS, BVS

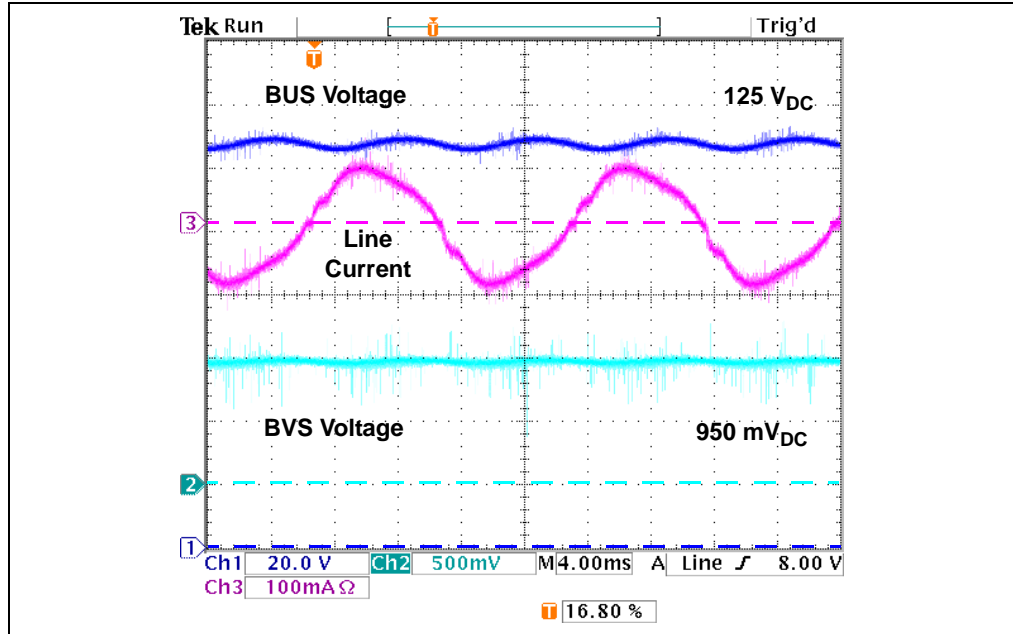

FIGURE D-6: Test Points BUS, BVS and the Line Current at a Line Voltage of 230V_{AC}.

D.2.3 DRN, CAP

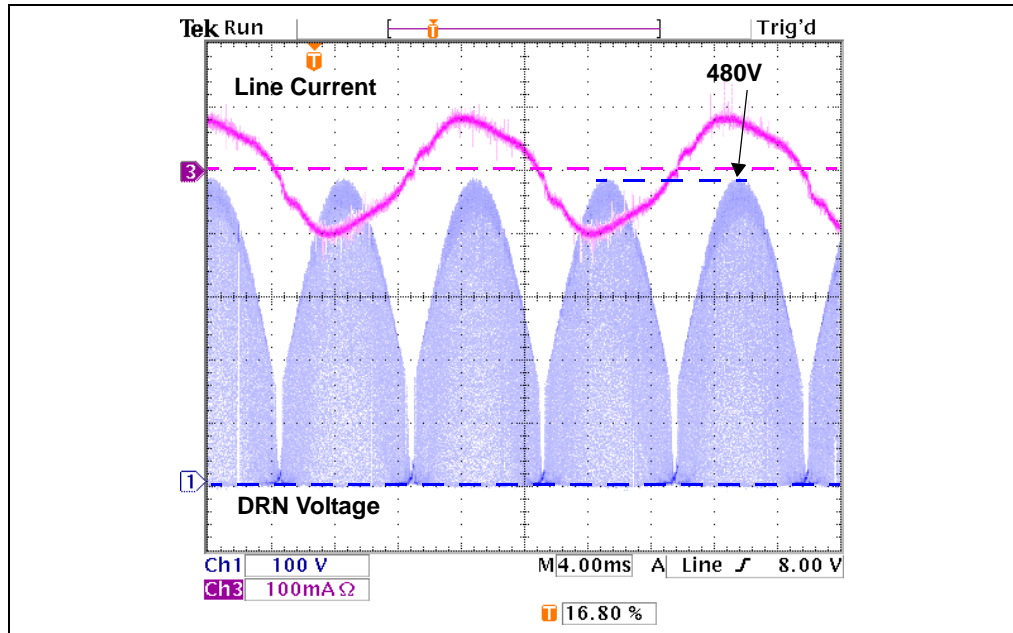

FIGURE D-7: Test Point DRN and the Line Current at a Line Voltage of 230V_{AC}.

Test Points and Waveforms

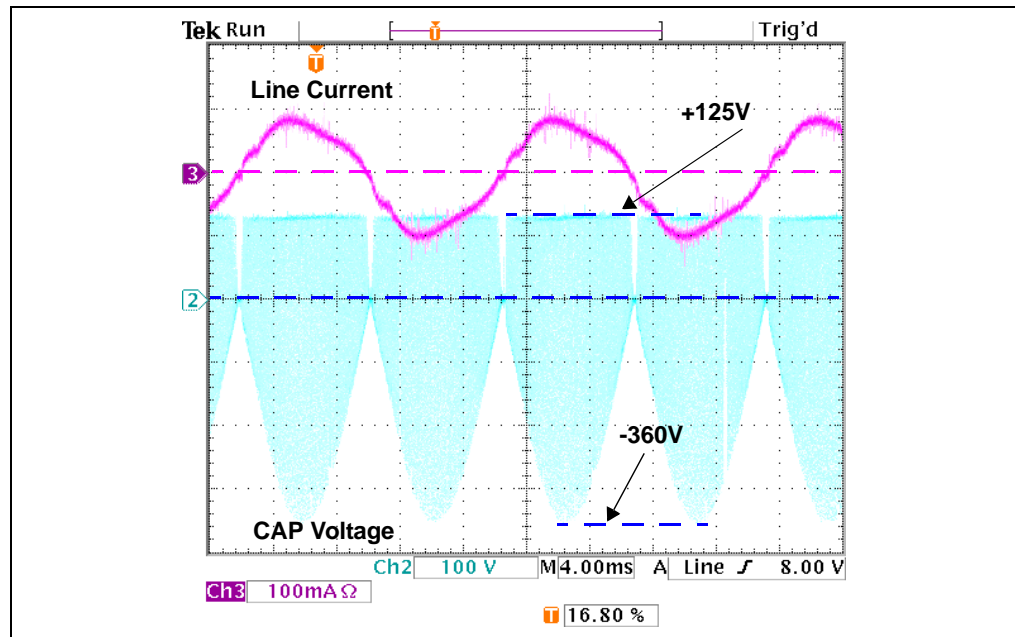

FIGURE D-8: Test Point CAP and the Line Current at a Line Voltage of 230V_{AC}.

D.2.4 DRN, REC

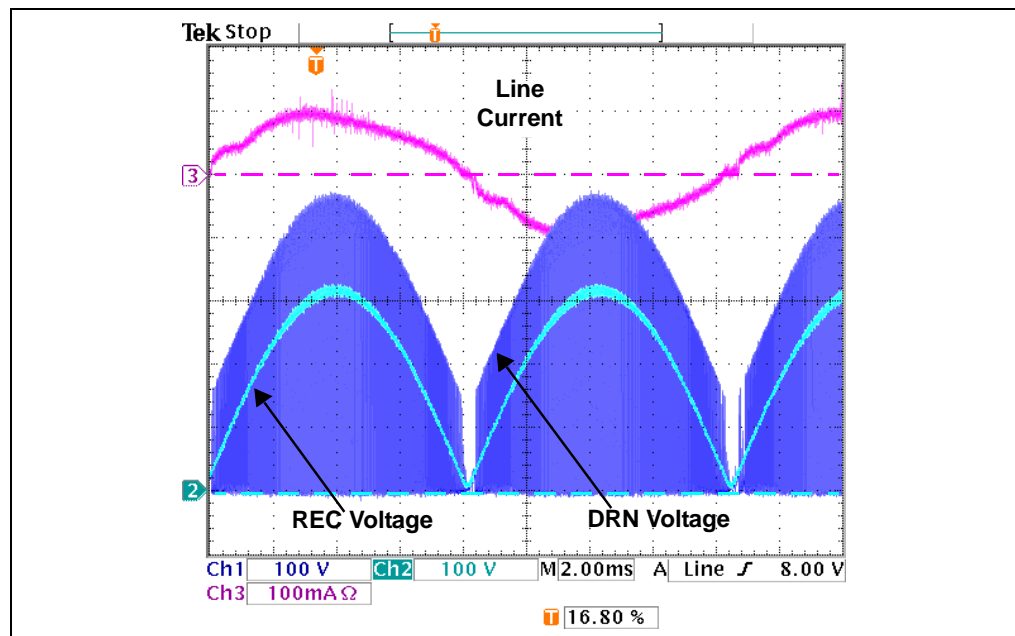

FIGURE D-9: Test Points DRN and REC and the Line Current at a Line Voltage of 230V_{AC}.

Test Points and Waveforms

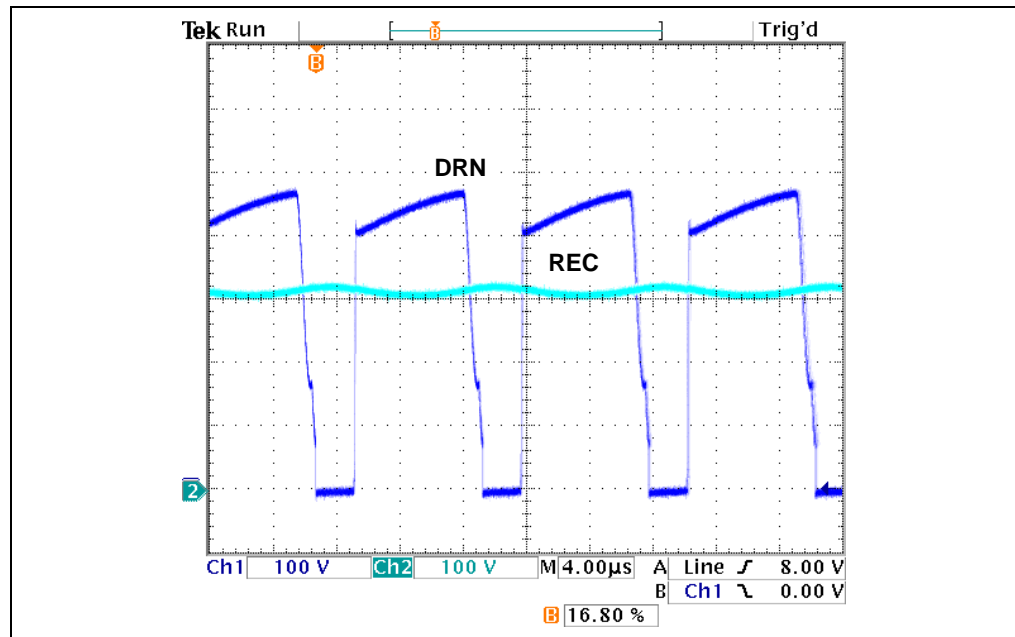

FIGURE D-10: Test Points DRN and REC Near the Peak of the Line Voltage at a Line Voltage of $230V_{AC}$.

D.2.5 DRN, DRV

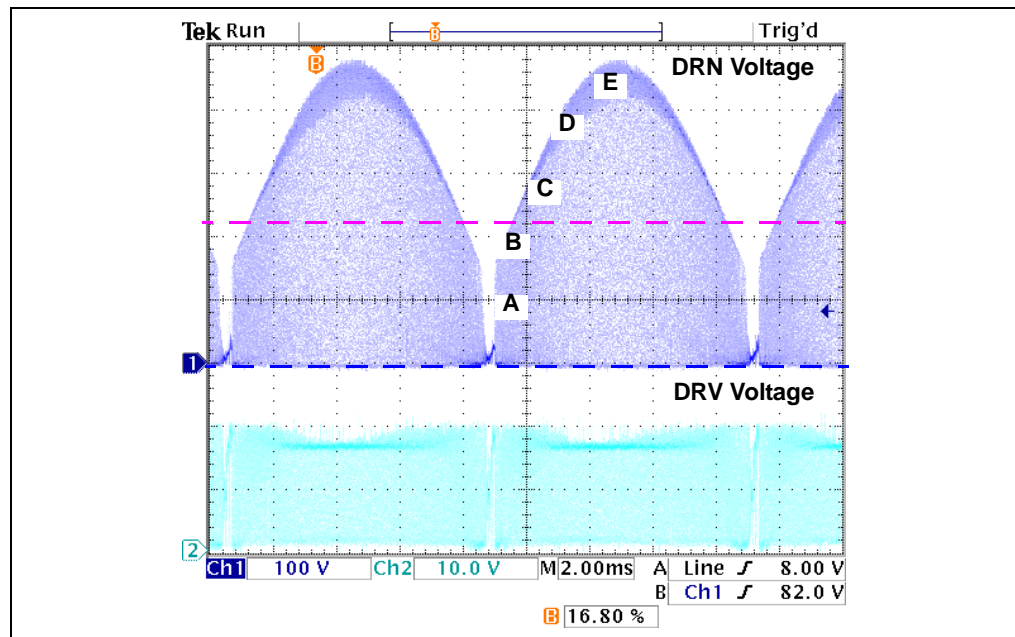

FIGURE D-11: Test Points DRN and DRV at a Line Voltage of $230V_{AC}$.

Test Points and Waveforms

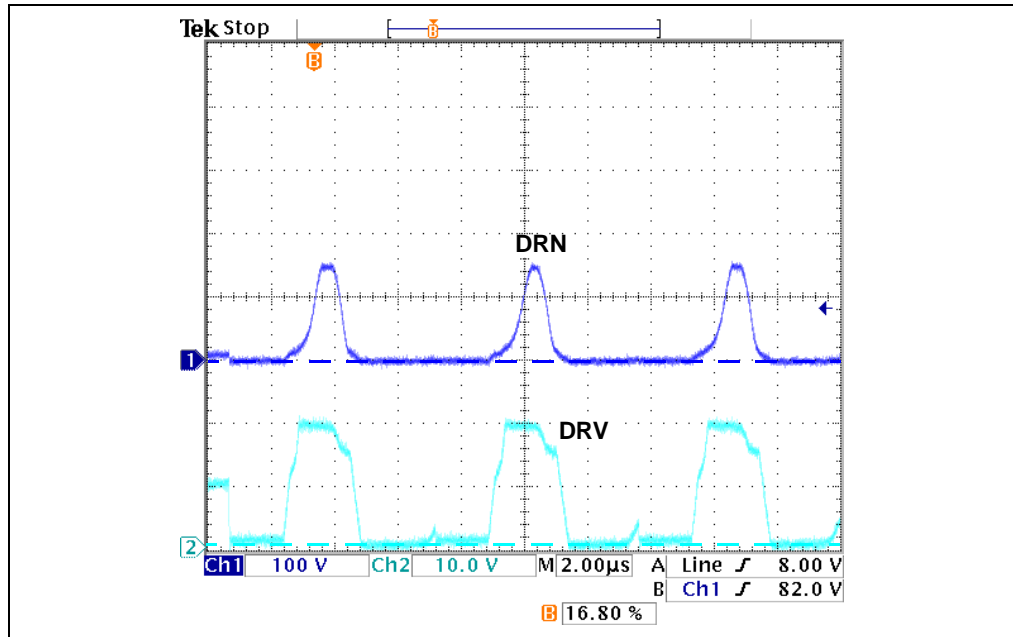

FIGURE D-12: Test Points DRN and DRV at Point A with Reference to Figure D-11.

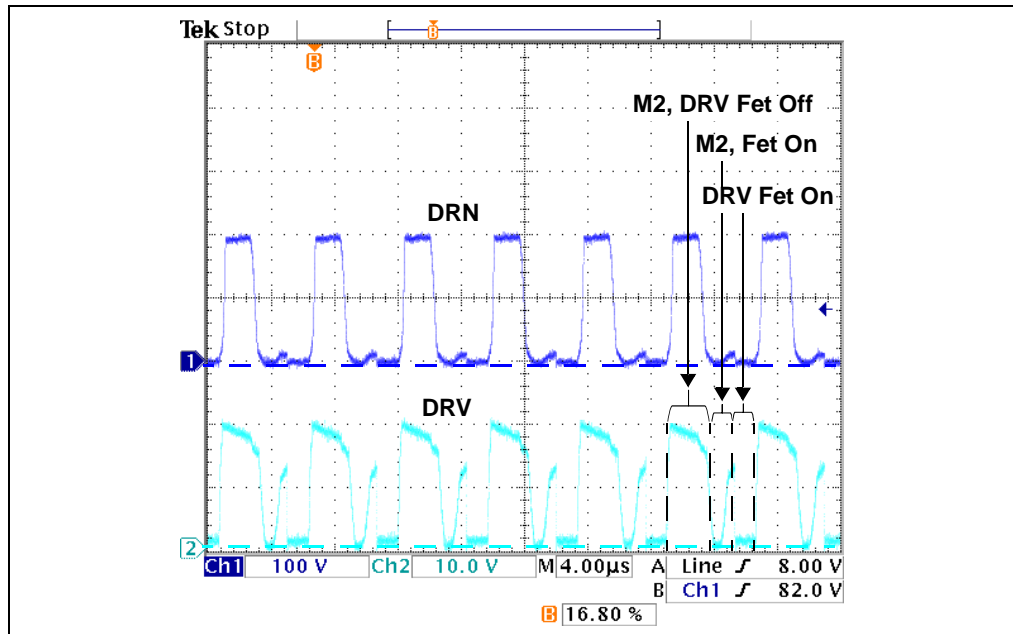

FIGURE D-13: Test Points DRN and DRV at Point B with Reference to Figure D-11.

Test Points and Waveforms

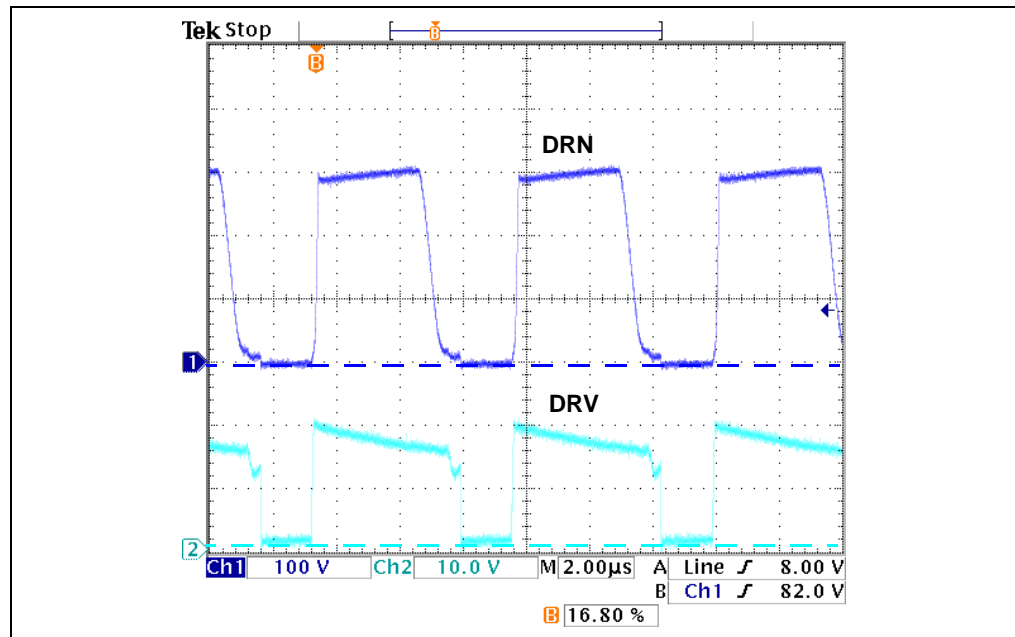

FIGURE D-14: Test Points DRN and DRV at Point C with Reference to Figure D-11.

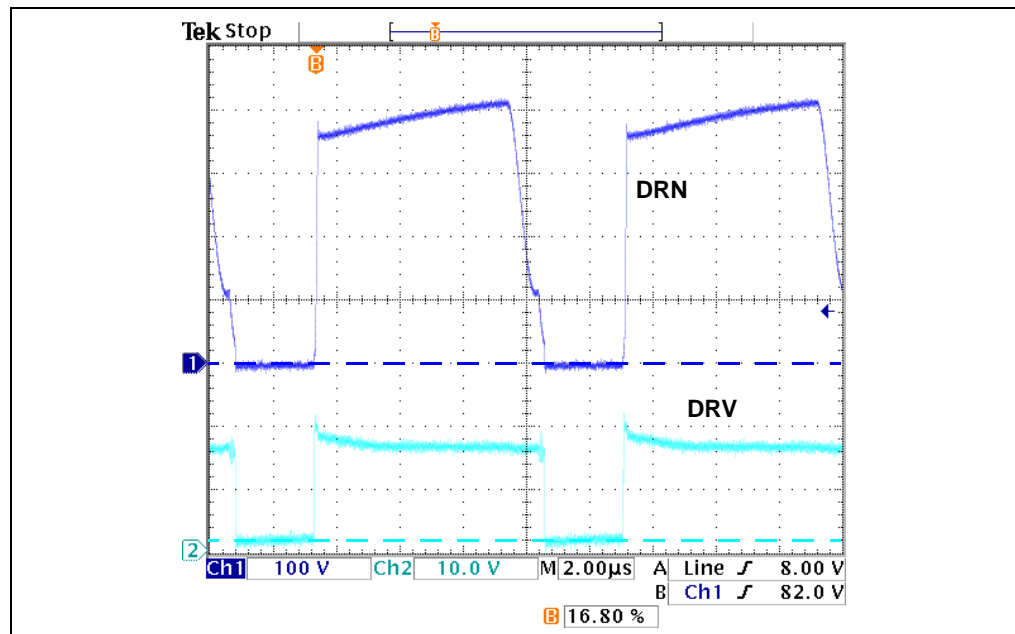

FIGURE D-15: Test Points DRN and DRV at Point D with Reference to Figure D-11.

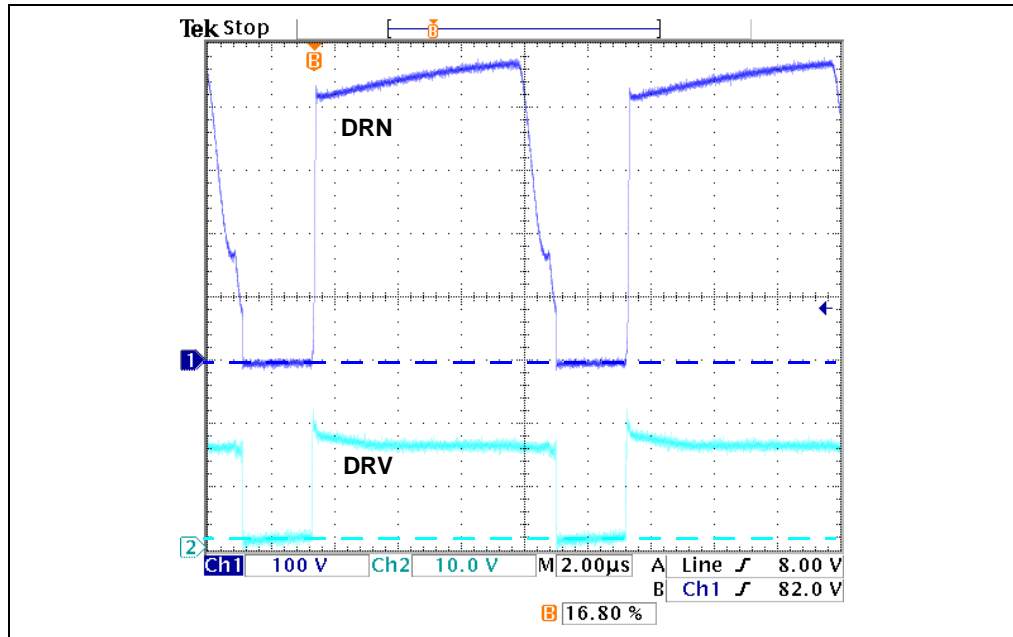

FIGURE D-16: Test Points DRN and DRV at Point E with Reference to Figure D-11.

D.2.6 Inductor Currents

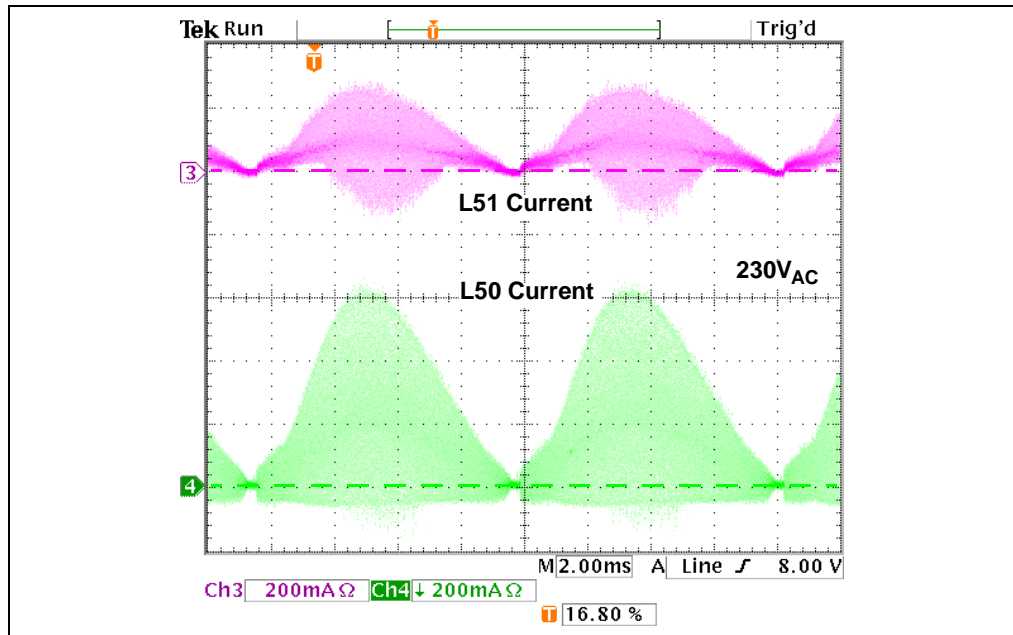

FIGURE D-17: Inductor Currents L50 L51 Current at a Line Voltage of 230V_{AC}.

Test Points and Waveforms

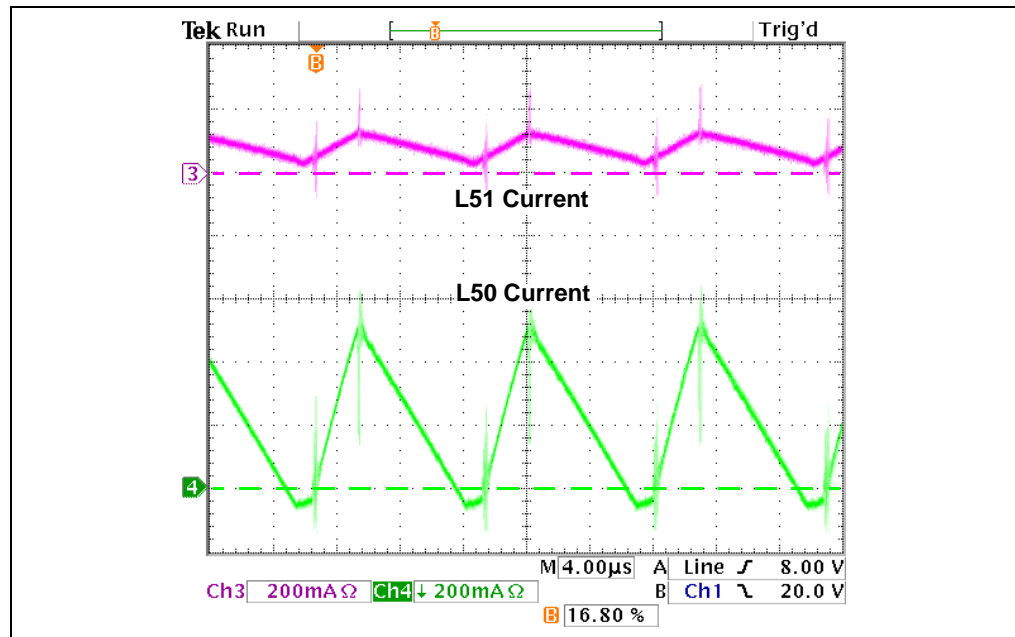

FIGURE D-18: Inductor Currents L50 and L51 Near the Peak of Line Voltage at a Line Voltage of $230V_{AC}$.

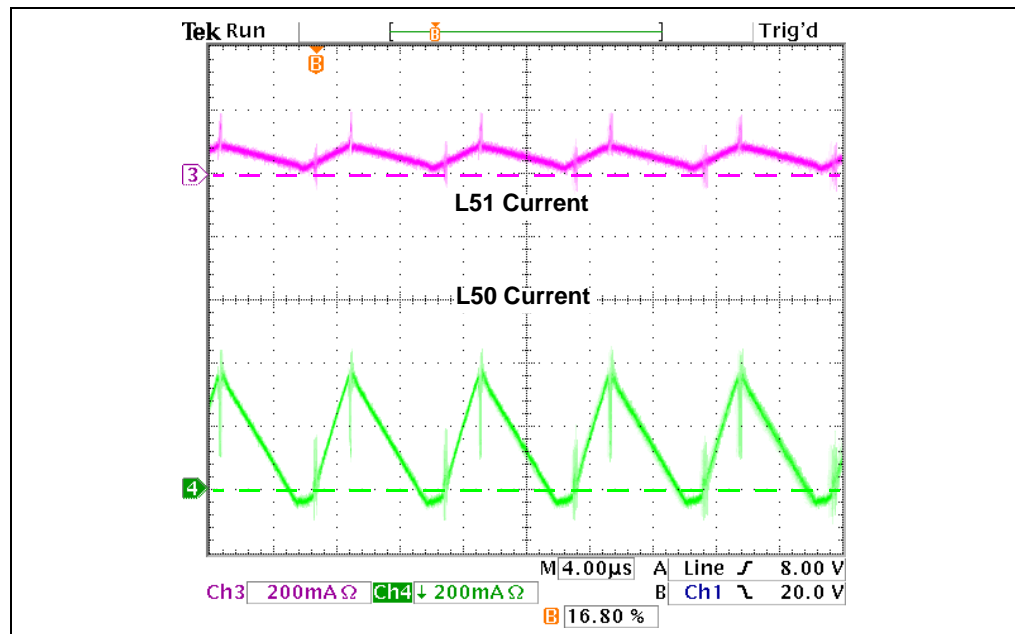

FIGURE D-19: Inductor Currents L50 and L51 Near the 45° Point of the Line Voltage at a Line Voltage of $230V_{AC}$.

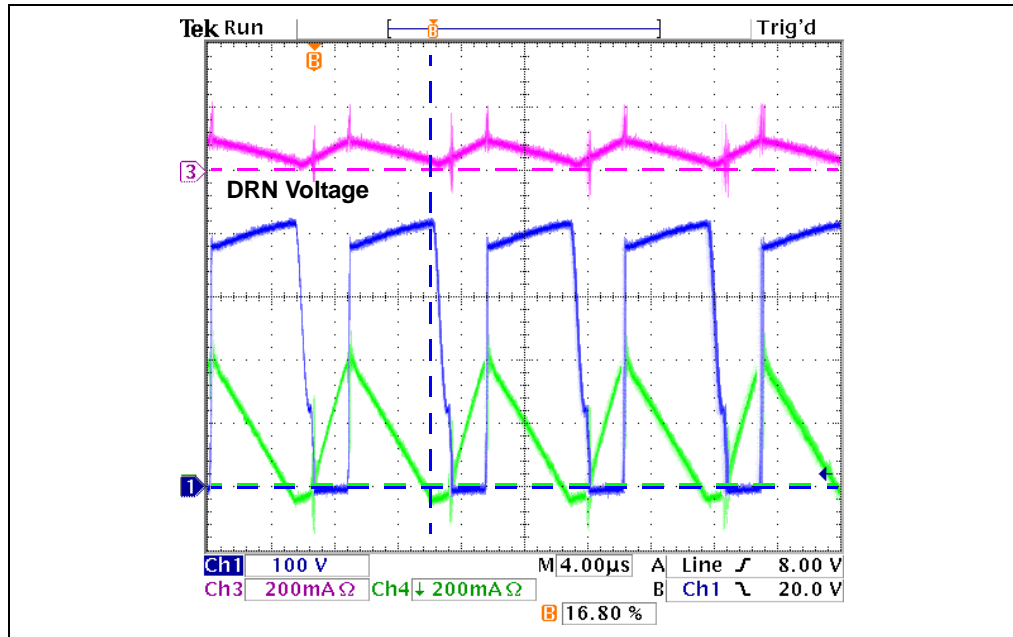

FIGURE D-20: Inductor Currents L50 and L51 and the Drain Voltage DRN Near the 45° Point of the Line Voltage at a Line Voltage of 230V_{AC}.

D.2.7 BUS, REG, HVS, CRG, CRS

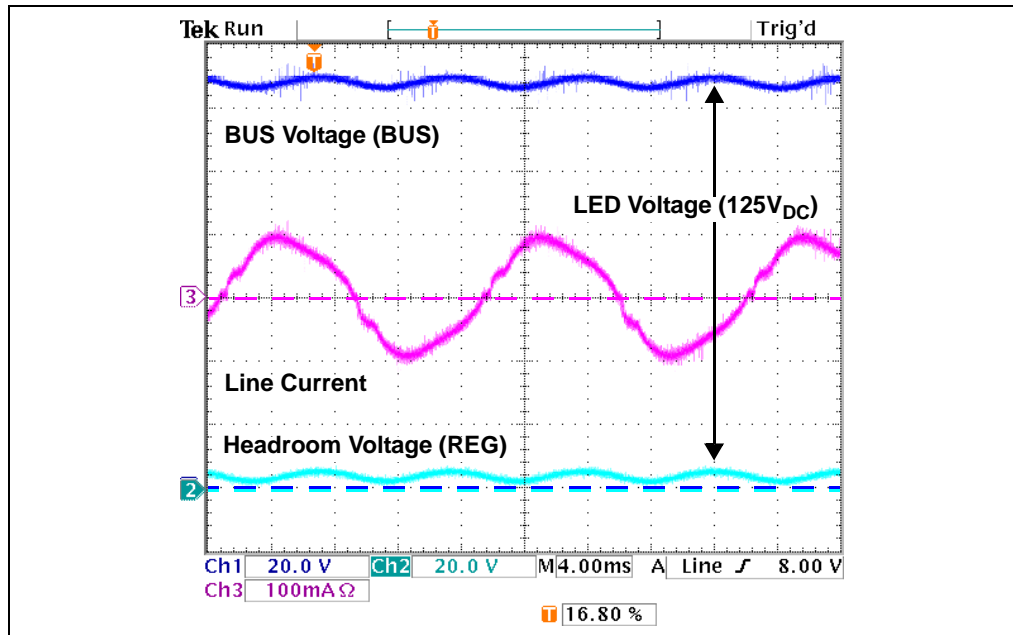

FIGURE D-21: Test Points BUS, REG and Line Current at a Line Voltage of 230V_{AC}.

Test Points and Waveforms

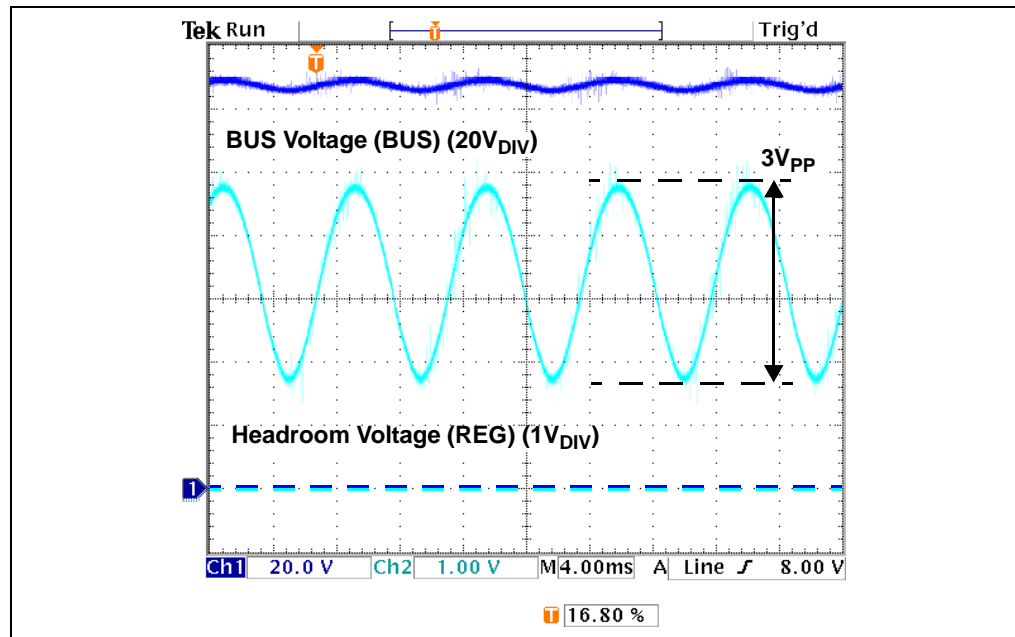

FIGURE D-22: Test Points BUS, REG and Line Current at a Line Voltage of 230V_{AC}.

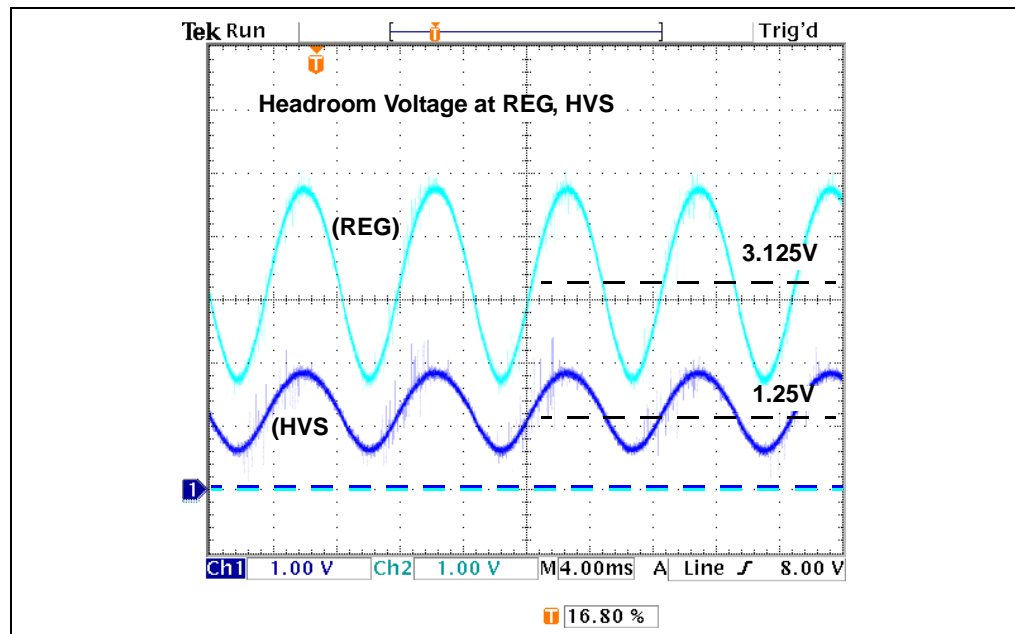

FIGURE D-23: Test Points REG and HVS at a Line Voltage of 230V_{AC}.

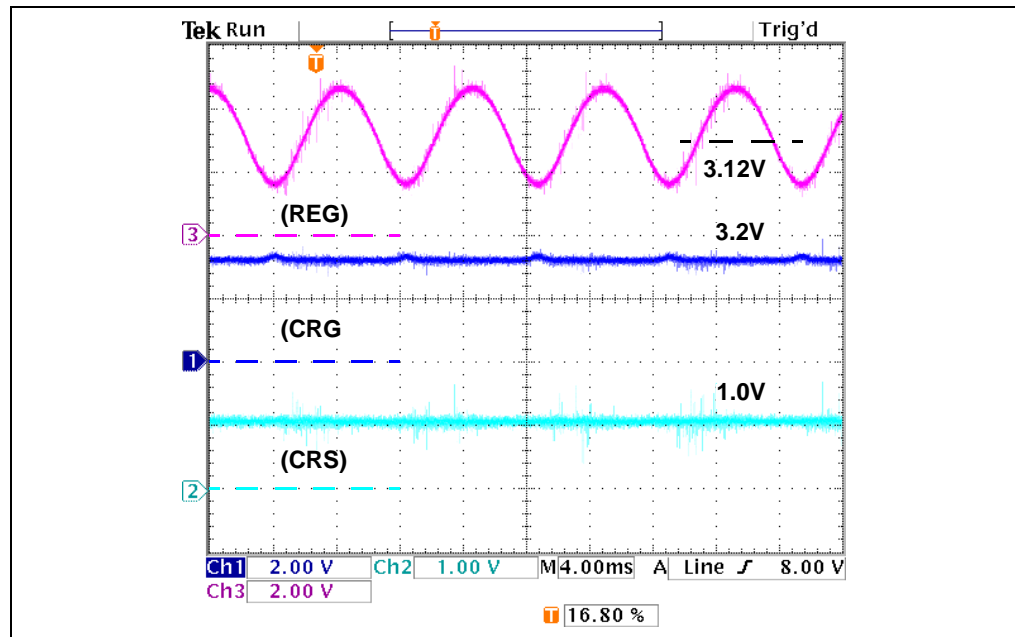

FIGURE D-24: Test Points REG, CRG and CRS at a Line Voltage of $230V_{AC}$.

D.2.8 HVR

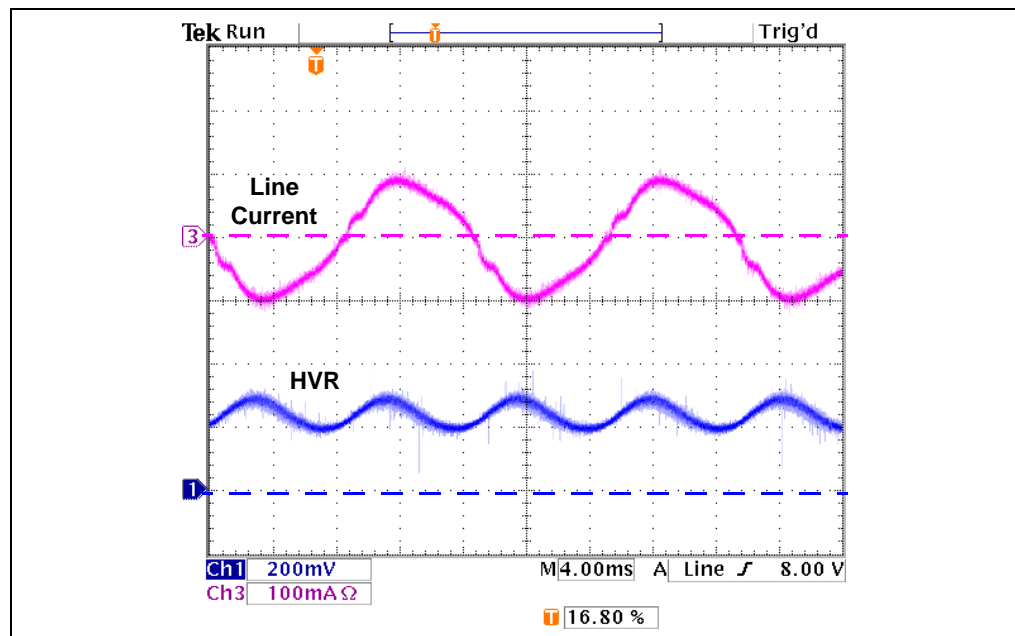

FIGURE D-25: Test Point HVR and the Line Current at a Line Voltage of $230V_{AC}$.

D.2.9 CSH

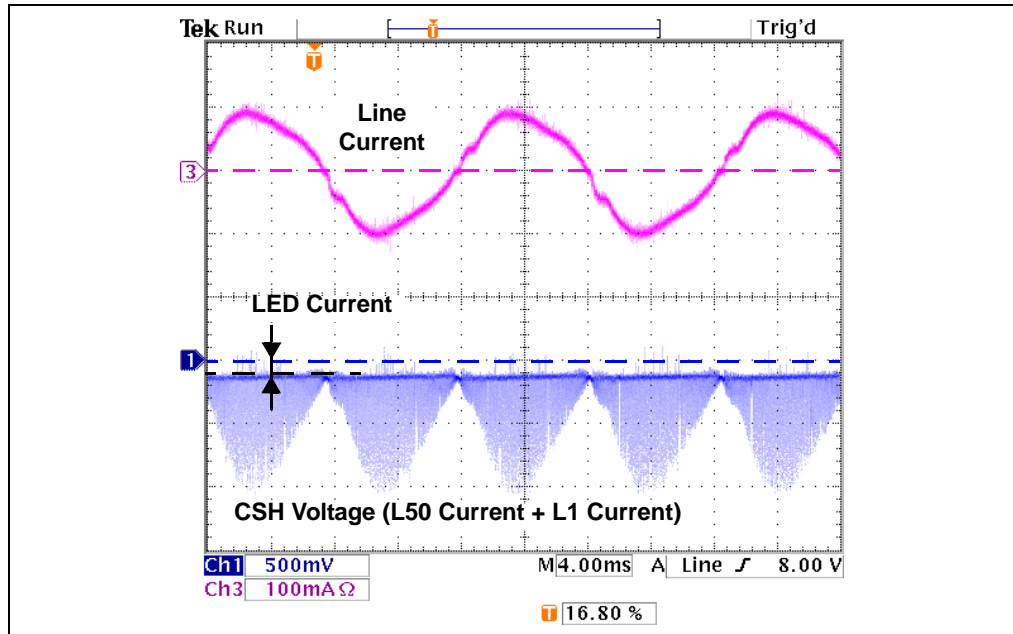

FIGURE D-26: Test Point CSH and the Line Current at a Line Voltage of 230V_{AC}.

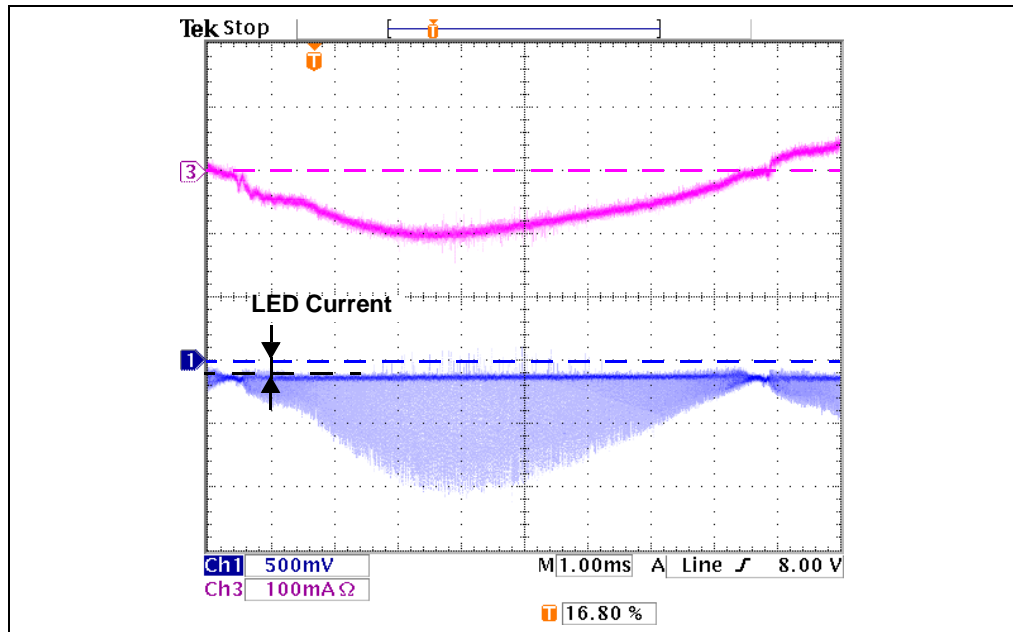

FIGURE D-27: Test Point CSH and the Line Current at a Line Voltage of 230V_{AC}.

Test Points and Waveforms

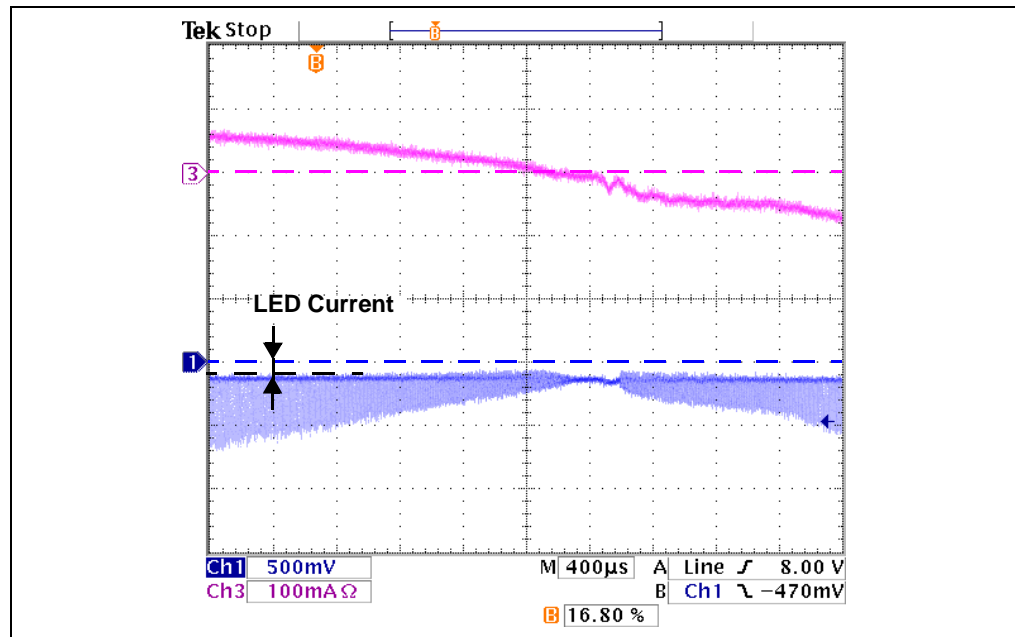

FIGURE D-28: Test Point CSH and the Line Current at a Line Voltage of 230V_{AC}.

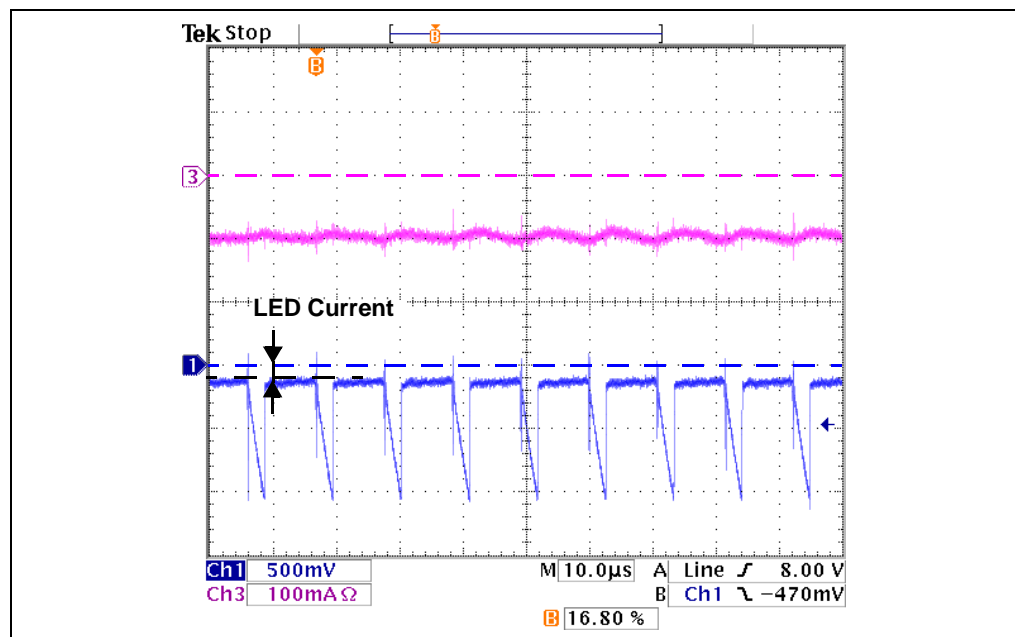

FIGURE D-29: Test Point CSH and the Line Current at a Line Voltage of 230V_{AC}.

D.2.10 V_{DD}

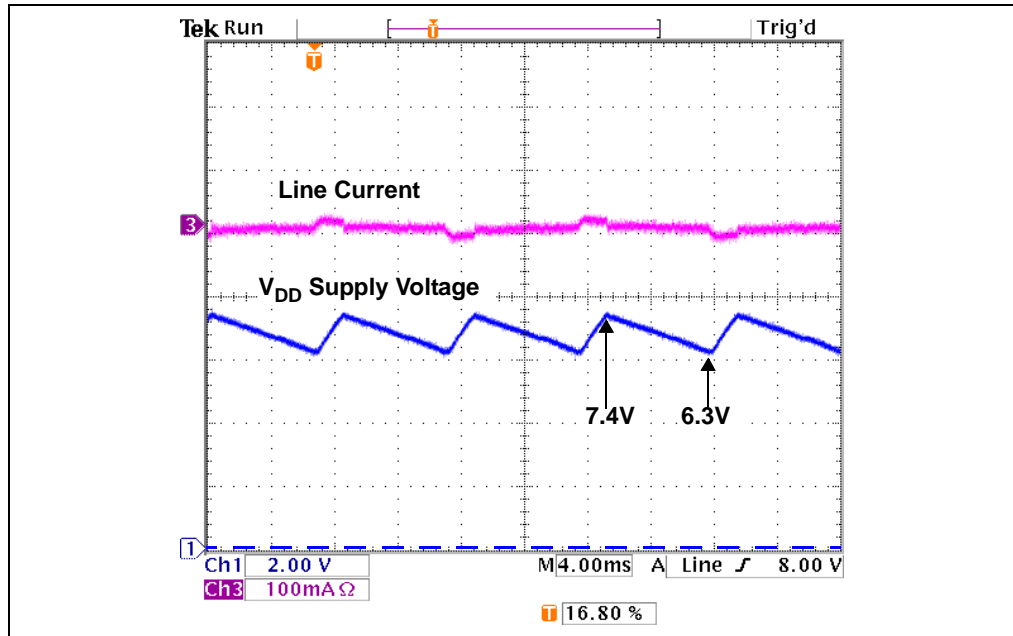

FIGURE D-30: Test Point V_{DD} and the Line Current at a Line Voltage of $15V_{AC}$.

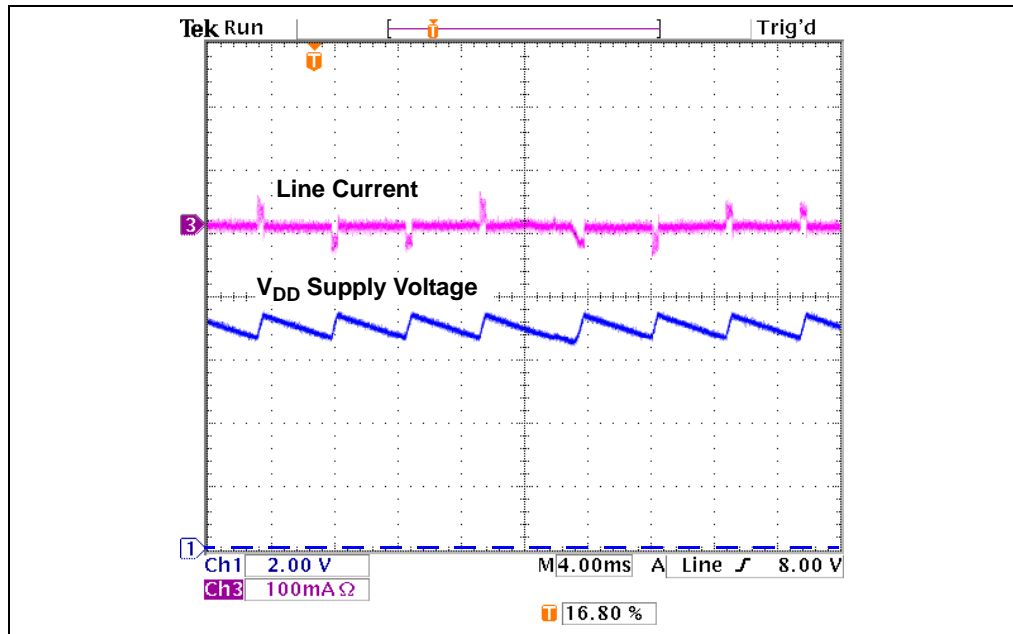

FIGURE D-31: Test Point V_{DD} and the Line Current at a Line Voltage of $30V_{AC}$.

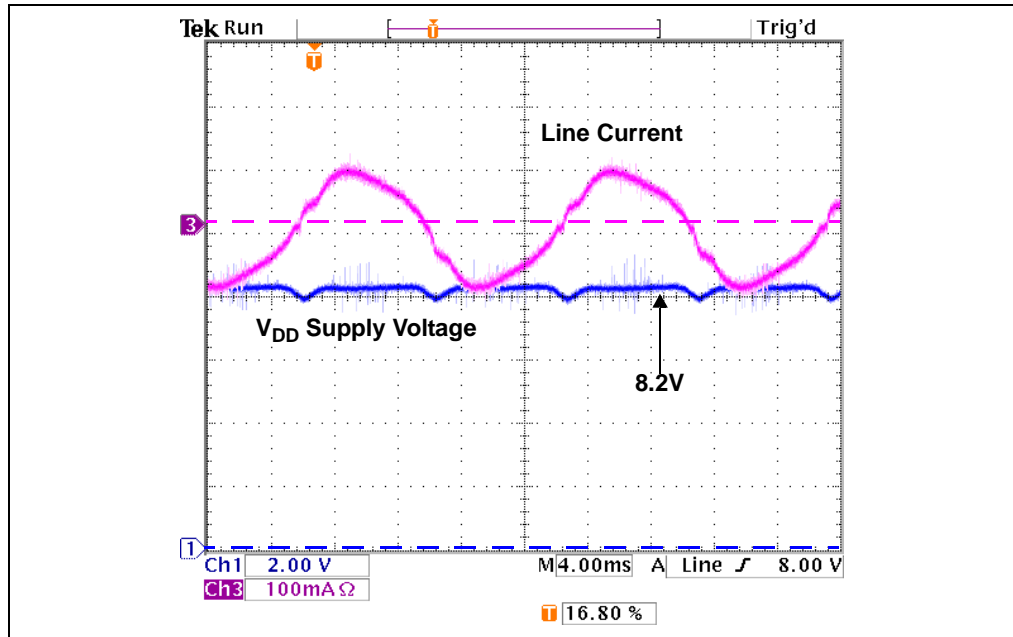

FIGURE D-32: Test Point V_{DD} and the Line Current at a Line Voltage of $230V_{AC}$.

NOTES:

Appendix E. Electromagnetic Interference

E.1 CISPR15 CONDUCTED EMISSIONS

E.1.1 Line

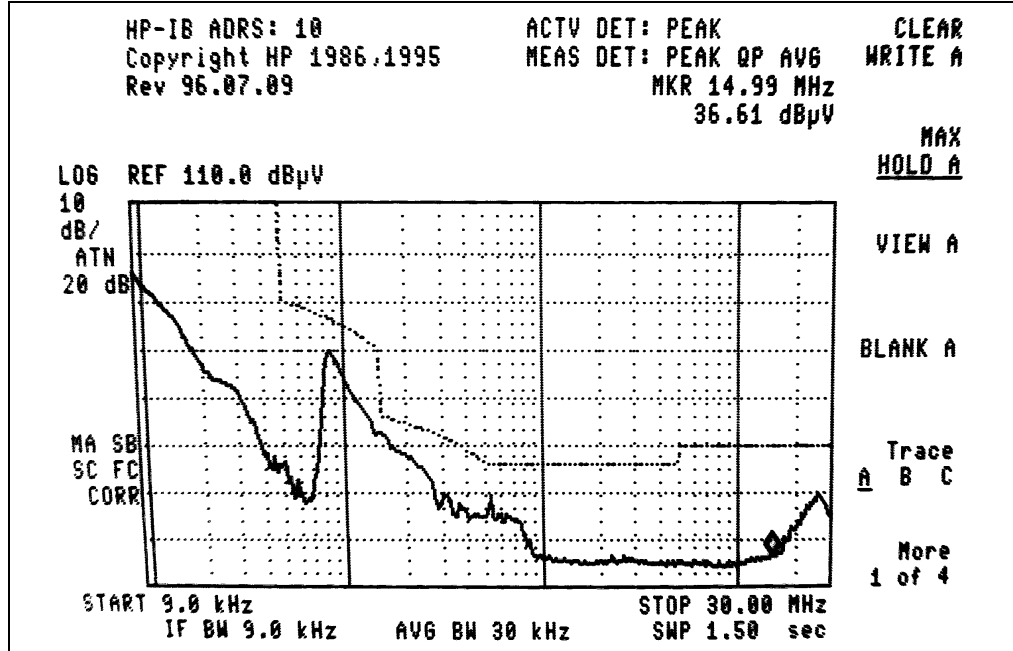

E.1.2 Neutral

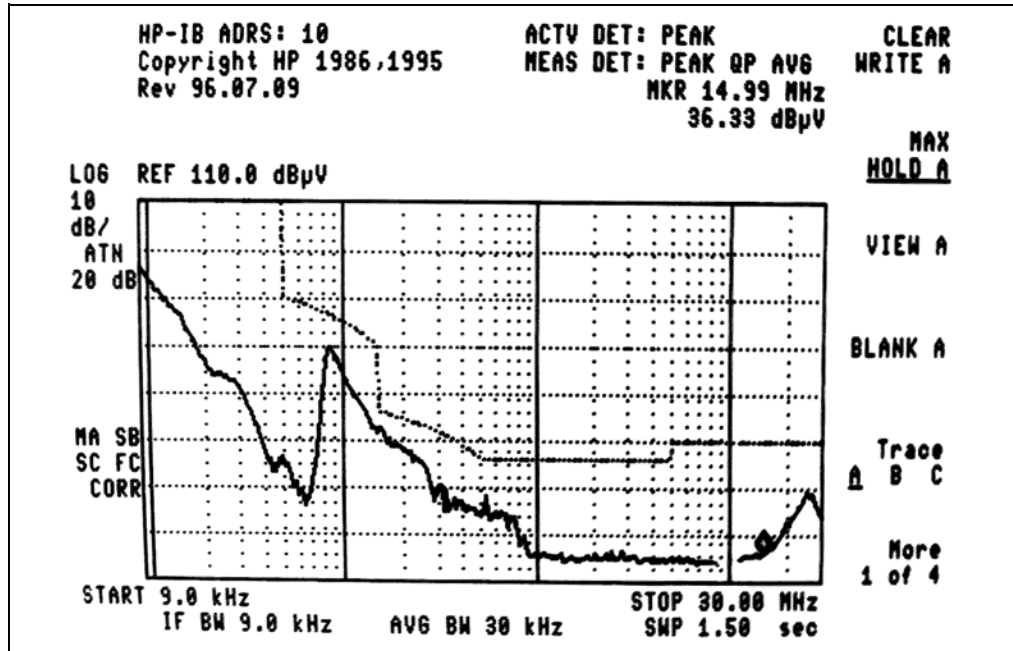



MICROCHIP

Worldwide Sales and Service

AMERICAS

Corporate Office
2355 West Chandler Blvd.
Chandler, AZ 85224-6199
Tel: 480-792-7200
Fax: 480-792-7277
Technical Support:
<http://www.microchip.com/support>
Web Address:
www.microchip.com

Atlanta
Duluth, GA
Tel: 678-957-9614
Fax: 678-957-1455

Austin, TX
Tel: 512-257-3370

Boston
Westborough, MA
Tel: 774-760-0087
Fax: 774-760-0088

Chicago
Itasca, IL
Tel: 630-285-0071
Fax: 630-285-0075

Cleveland
Independence, OH
Tel: 216-447-0464
Fax: 216-447-0643

Dallas
Addison, TX
Tel: 972-818-7423
Fax: 972-818-2924

Detroit
Novi, MI
Tel: 248-848-4000

Houston, TX
Tel: 281-894-5983

Indianapolis
Noblesville, IN
Tel: 317-773-8323
Fax: 317-773-5453

Los Angeles
Mission Viejo, CA
Tel: 949-462-9523
Fax: 949-462-9608

New York, NY
Tel: 631-435-6000

San Jose, CA
Tel: 408-735-9110

Canada - Toronto
Tel: 905-673-0699
Fax: 905-673-6509

ASIA/PACIFIC

Asia Pacific Office
Suites 3707-14, 37th Floor
Tower 6, The Gateway
Harbour City, Kowloon
Hong Kong
Tel: 852-2943-5100
Fax: 852-2401-3431

Australia - Sydney
Tel: 61-2-9868-6733
Fax: 61-2-9868-6755

China - Beijing
Tel: 86-10-8569-7000
Fax: 86-10-8528-2104

China - Chengdu
Tel: 86-28-8665-5511
Fax: 86-28-8665-7889

China - Chongqing
Tel: 86-23-8980-9588
Fax: 86-23-8980-9500

China - Dongguan
Tel: 86-769-8702-9880

China - Hangzhou
Tel: 86-571-8792-8115
Fax: 86-571-8792-8116

China - Hong Kong SAR
Tel: 852-2943-5100
Fax: 852-2401-3431

China - Nanjing
Tel: 86-25-8473-2460
Fax: 86-25-8473-2470

China - Qingdao
Tel: 86-532-8502-7355
Fax: 86-532-8502-7205

China - Shanghai
Tel: 86-21-5407-5533
Fax: 86-21-5407-5066

China - Shenyang
Tel: 86-24-2334-2829
Fax: 86-24-2334-2393

China - Shenzhen
Tel: 86-755-8864-2200
Fax: 86-755-8203-1760

China - Wuhan
Tel: 86-27-5980-5300
Fax: 86-27-5980-5118

China - Xian
Tel: 86-29-8833-7252
Fax: 86-29-8833-7256

ASIA/PACIFIC

China - Xiamen
Tel: 86-592-2388138
Fax: 86-592-2388130

China - Zhuhai
Tel: 86-756-3210040
Fax: 86-756-3210049

India - Bangalore
Tel: 91-80-3090-4444
Fax: 91-80-3090-4123

India - New Delhi
Tel: 91-11-4160-8631
Fax: 91-11-4160-8632

India - Pune
Tel: 91-20-3019-1500

Japan - Osaka
Tel: 81-6-6152-7160
Fax: 81-6-6152-9310

Japan - Tokyo
Tel: 81-3-6880-3770
Fax: 81-3-6880-3771

Korea - Daegu
Tel: 82-53-744-4301
Fax: 82-53-744-4302

Korea - Seoul
Tel: 82-2-554-7200
Fax: 82-2-558-5932 or
82-2-558-5934

Malaysia - Kuala Lumpur
Tel: 60-3-6201-9857
Fax: 60-3-6201-9859

Malaysia - Penang
Tel: 60-4-227-8870
Fax: 60-4-227-4068

Philippines - Manila
Tel: 63-2-634-9065
Fax: 63-2-634-9069

Singapore
Tel: 65-6334-8870
Fax: 65-6334-8850

Taiwan - Hsin Chu
Tel: 886-3-5778-366
Fax: 886-3-5770-955

Taiwan - Kaohsiung
Tel: 886-7-213-7828

Taiwan - Taipei
Tel: 886-2-2508-8600
Fax: 886-2-2508-0102

Thailand - Bangkok
Tel: 66-2-694-1351
Fax: 66-2-694-1350

EUROPE

Austria - Wels
Tel: 43-7242-2244-39
Fax: 43-7242-2244-393

Denmark - Copenhagen
Tel: 45-4450-2828
Fax: 45-4485-2829

France - Paris
Tel: 33-1-69-53-63-20
Fax: 33-1-69-30-90-79

Germany - Dusseldorf
Tel: 49-2129-3766400

Germany - Munich
Tel: 49-89-627-144-0
Fax: 49-89-627-144-44

Germany - Pforzheim
Tel: 49-7231-424750

Italy - Milan
Tel: 39-0331-742611
Fax: 39-0331-466781

Italy - Venice
Tel: 39-049-7625286

Netherlands - Drunen
Tel: 31-416-690399
Fax: 31-416-690340

Poland - Warsaw
Tel: 48-22-3325737

Spain - Madrid
Tel: 34-91-708-08-90
Fax: 34-91-708-08-91

Sweden - Stockholm
Tel: 46-8-5090-4654

UK - Wokingham
Tel: 44-118-921-5800
Fax: 44-118-921-5820

01/27/15

Mouser Electronics

Authorized Distributor

Click to View Pricing, Inventory, Delivery & Lifecycle Information:

[Microchip:](#)

[ADM00656](#)