



**MPLAB[®] PM3
USER'S GUIDE**

Note the following details of the code protection feature on Microchip devices:

- Microchip products meet the specification contained in their particular Microchip Data Sheet.
- Microchip believes that its family of products is one of the most secure families of its kind on the market today, when used in the intended manner and under normal conditions.
- There are dishonest and possibly illegal methods used to breach the code protection feature. All of these methods, to our knowledge, require using the Microchip products in a manner outside the operating specifications contained in Microchip's Data Sheets. Most likely, the person doing so is engaged in theft of intellectual property.
- Microchip is willing to work with the customer who is concerned about the integrity of their code.
- Neither Microchip nor any other semiconductor manufacturer can guarantee the security of their code. Code protection does not mean that we are guaranteeing the product as "unbreakable."

Code protection is constantly evolving. We at Microchip are committed to continuously improving the code protection features of our products. Attempts to break Microchip's code protection feature may be a violation of the Digital Millennium Copyright Act. If such acts allow unauthorized access to your software or other copyrighted work, you may have a right to sue for relief under that Act.

Information contained in this publication regarding device applications and the like is provided only for your convenience and may be superseded by updates. It is your responsibility to ensure that your application meets with your specifications. MICROCHIP MAKES NO REPRESENTATIONS OR WARRANTIES OF ANY KIND WHETHER EXPRESS OR IMPLIED, WRITTEN OR ORAL, STATUTORY OR OTHERWISE, RELATED TO THE INFORMATION, INCLUDING BUT NOT LIMITED TO ITS CONDITION, QUALITY, PERFORMANCE, MERCHANTABILITY OR FITNESS FOR PURPOSE. Microchip disclaims all liability arising from this information and its use. Use of Microchip devices in life support and/or safety applications is entirely at the buyer's risk, and the buyer agrees to defend, indemnify and hold harmless Microchip from any and all damages, claims, suits, or expenses resulting from such use. No licenses are conveyed, implicitly or otherwise, under any Microchip intellectual property rights.

Trademarks

The Microchip name and logo, the Microchip logo, Accuron, dsPIC, KEELOQ, microID, MPLAB, PIC, PICmicro, PICSTART, PRO MATE, PowerSmart, rPIC and SmartShunt are registered trademarks of Microchip Technology Incorporated in the U.S.A. and other countries.

AmpLab, FilterLab, Migratable Memory, MXDEV, MXLAB, SEEVAL, SmartSensor and The Embedded Control Solutions Company are registered trademarks of Microchip Technology Incorporated in the U.S.A.

Analog-for-the-Digital Age, Application Maestro, dsPICDEM, dsPICDEM.net, dsPICworks, ECAN, ECONOMONITOR, FanSense, FlexROM, fuzzyLAB, In-Circuit Serial Programming, ICSP, ICEPIC, Linear Active Thermistor, MPASM, MPLIB, MPLINK, MPSIM, PICkit, PICDEM, PICDEM.net, PICLAB, PICTail, PowerCal, PowerInfo, PowerMate, PowerTool, Real ICE, rFLAB, rPICDEM, Select Mode, Smart Serial, SmartTel, Total Endurance, UNI/O, WiperLock and Zena are trademarks of Microchip Technology Incorporated in the U.S.A. and other countries.

SQTP is a service mark of Microchip Technology Incorporated in the U.S.A.

All other trademarks mentioned herein are property of their respective companies.

© 2006, Microchip Technology Incorporated, Printed in the U.S.A., All Rights Reserved.

 Printed on recycled paper.

QUALITY MANAGEMENT SYSTEM
CERTIFIED BY DNV
== ISO/TS 16949:2002 ==

Microchip received ISO/TS-16949:2002 quality system certification for its worldwide headquarters, design and wafer fabrication facilities in Chandler and Tempe, Arizona and Mountain View, California in October 2003. The Company's quality system processes and procedures are for its PICmicro® 8-bit MCUs, KEELOQ® code hopping devices, Serial EEPROMs, microperipherals, nonvolatile memory and analog products. In addition, Microchip's quality system for the design and manufacture of development systems is ISO 9001:2000 certified.

Table of Contents

Preface	1
Chapter 1. MPLAB PM3 Overview	
1.1 Introduction	7
1.2 What is MPLAB PM3?	7
1.3 What MPLAB PM3 Does	7
1.4 MPLAB PM3 System Components	8
1.5 MPLAB PM3 CE Compliance	8
1.6 How MPLAB PM3 Helps You	9
1.7 MPLAB PM3 Operating with a PC	9
1.8 MPLAB PM3 Operating without a PC (Stand-alone)	9
1.9 MPLAB Integrated Development Environment	9
1.10 MPLAB Development Tools	10
Chapter 2. Installing MPLAB PM3	
2.1 Introduction	11
2.2 Installing MPLAB PM3 Software	11
2.3 Installing MPLAB PM3 Hardware	12
2.4 Powering Up MPLAB PM3	15
2.5 Configuring MPLAB IDE for Use with MPLAB PM3	16
Chapter 3. Tutorial	
3.1 Introduction	23
3.2 Before You Begin	23
3.3 Programming Overview	23
3.4 Selecting the Device	24
3.5 Creating the Project	24
3.6 Setting Up Language Tools	26
3.7 Naming the Project	27
3.8 Adding Files to the Project	28
3.9 Building the Initial Project	30
3.10 Creating Code	31
3.11 Building the Project	34
3.12 Enabling MPLAB PM3	35
3.13 Programming the Device	36
3.14 Verifying the Programming	36
3.15 Tutorial Summary	36

MPLAB® PM3 User's Guide

Chapter 4. Using MPLAB PM3 with MPLAB IDE

4.1 Introduction	37
4.2 Before You Begin	37
4.3 MPLAB PM3 Dialogs	37
4.4 Setup for Programming a Device	37
4.5 Programming a Device	38
4.6 Verifying the Programming	42
4.7 Reading a Device	43
4.8 Special Programming	43

Chapter 5. Using MPLAB PM3 in Stand-Alone Mode

5.1 Introduction	45
5.2 Getting Started in Stand-alone Mode	45
5.3 Programming a Device	46

Chapter 6. Using the MPLAB PM3 Card

6.1 Introduction	49
6.2 MPLAB PM3 Environment	50
6.3 MPLAB PM3 Card	53

Chapter 7. MPLAB PM3 – MPLAB IDE Reference

7.1 Introduction	55
7.2 MPLAB PM3 Toolbar	55
7.3 Configure Menu	56
7.4 MPLAB PM3 Programmer Menu	57
7.5 Programmer Settings	62
7.6 Special Programming	70
7.7 Files Used by MPLAB PM3	74
7.8 Upgrading the MPLAB PM3 Operating System	75

Chapter 8. Stand-Alone Reference

8.1 Introduction	77
8.2 MPLAB PM3 LCD and Keys	77
8.3 Start-Up Sequence	78
8.4 Main Menu	78
8.5 Command Menu	82

Chapter 9. MPLAB PM3 Card Reference

9.1 Introduction	87
9.2 MPLAB PM3 Card	87
9.3 MPLAB PM3 Card Through MPLAB IDE	87
9.4 MPLAB PM3 Card in Stand-alone Mode	97

Appendix A. Hardware Specifications	
A.1 Introduction	99
A.2 Connecting to a PC via the Serial Port	99
A.3 Programmer Specifications	100
A.4 ICSP Hardware Specifications	101
A.5 Socket Module Specifications	104
Appendix B. Troubleshooting	
B.1 Introduction	107
B.2 Troubleshooting Hardware	107
B.3 Troubleshooting Operational Problems	108
B.4 Troubleshooting Software	108
B.5 Common Problems	110
B.6 Error Messages – PC	113
B.7 Error Messages – LCD	114
B.8 Limitations	116
Glossary	117
Index	131
Worldwide Sales and Service	134

MPLAB[®] PM3 User's Guide

NOTES:

Preface

NOTICE TO CUSTOMERS

All documentation becomes dated, and this manual is no exception. Microchip tools and documentation are constantly evolving to meet customer needs, so some actual dialogs and/or tool descriptions may differ from those in this document. Please refer to our web site (www.microchip.com) to obtain the latest documentation available.

Documents are identified with a “DS” number. This number is located on the bottom of each page, in front of the page number. The numbering convention for the DS number is “DSXXXXA”, where “XXXX” is the document number and “A” is the revision level of the document.

For the most up-to-date information on development tools, see the MPLAB® IDE on-line help. Select the Help menu, and then Topics to open a list of available on-line help files.

INTRODUCTION

This chapter contains general information that will be useful to know before using MPLAB PM3. Items discussed include:

- Document Layout
- Conventions Used in this Guide
- Warranty Registration
- Recommended Reading
- The Microchip Web Site
- Development Systems Customer Change Notification Service
- Customer Support

DOCUMENT LAYOUT

This document describes how to use MPLAB PM3 as a development tool to emulate and debug firmware on a target board. The manual layout is as follows:

- **Chapter 1. MPLAB PM3 Overview** – Describes MPLAB PM3 and how it works.
- **Chapter 2. Installing MPLAB PM3** – Describes how to install MPLAB PM3 hardware and MPLAB software. Explains how to set up MPLAB IDE and MPLAB PM3 to work together and how to start MPLAB PM3 from MPLAB.
- **Chapter 3. Tutorial**– Contains several examples (tutorials) for programming calibration memory devices, memory devices and other PICmicro® MCU devices.
- **Chapter 4. Using MPLAB PM3 with MPLAB IDE** – Provides step-by-step instructions on using MPLAB PM3 with MPLAB IDE to program, read and verify devices.
- **Chapter 5. Using MPLAB PM3 in Stand-Alone Mode** – Provides instructions for using MPLAB PM3 in Stand-Alone mode.
- **Chapter 6. Using the MPLAB PM3 Card** – Provides instructions for using the MPLAB PM3 Card.
- **Chapter 7. MPLAB PM3 – MPLAB IDE Reference** – Describes the commands available through the MPLAB PM3 command line interface as well as error messages.
- **Chapter 8. Stand-Alone Reference** – Describes the commands available through the MPLAB PM3 LCD.
- **Chapter 9. MPLAB PM3 Card Reference** – Describes the commands available specifically for the MPLAB PM3 Card.
- **Appendix A. Hardware Specifications** – Describes how to connect MPLAB PM3 to a communication port. Provides instructions on cleaning MPLAB PM3 socket modules.
- **Appendix B. Troubleshooting** – Provides information on solving common problems.

CONVENTIONS USED IN THIS GUIDE

This manual uses the following documentation conventions:

DOCUMENTATION CONVENTIONS

Description	Represents	Examples
Arial font:		
Italic characters	Referenced books	<i>MPLAB[®] IDE User's Guide</i>
	Emphasized text	...is the <i>only</i> compiler...
Initial caps	A window	the Output window
	A dialog	the Settings dialog
	A menu selection	select Enable Programmer
Quotes	A field name in a window or dialog	"Save project before build"
Underlined, italic text with right angle bracket	A menu path	<u><i>File>Save</i></u>
Bold characters	A dialog button	Click OK
	A tab	Click the Power tab
N'Rnnnn	A number in verilog format, where N is the total number of digits, R is the radix and n is a digit.	4'b0010, 2'hF1
Text in angle brackets < >	A key on the keyboard	Press <Enter>, <F1>
Courier New font:		
Plain Courier New	Sample source code	#define START
	Filenames	autoexec.bat
	File paths	c:\mcc18\h
	Keywords	_asm, _endasm, static
	Command-line options	-Opa+, -Opa-
	Bit values	0, 1
	Constants	0xFF, 'A'
Italic Courier New	A variable argument	file.o, where file can be any valid filename
Square brackets []	Optional arguments	mcc18 [options] file [options]
Curly brackets and pipe character: { }	Choice of mutually exclusive arguments; an OR selection	errorlevel {0 1}
Ellipses...	Replaces repeated text	var_name [, var_name...]
	Represents code supplied by user	void main (void) { ... }

MPLAB[®] PM3 User's Guide

WARRANTY REGISTRATION

Please complete the enclosed Warranty Registration Card and mail it promptly. Sending in the Warranty Registration Card entitles users to receive new product updates. Interim software releases are available at the Microchip web site.

RECOMMENDED READING

This user's guide describes how to use the MPLAB PM3 programmer. Other useful documents are listed below. The following Microchip documents are available and recommended as supplemental reference resources.

README for MPLAB PM3

For the latest information on using MPLAB PM3, read the `Readme for MPLAB PM3.txt` file (an ASCII text file) in the MPLAB IDE\readmes directory. The README file contains update information and known issues that may not be included in this on-line help file.

MPLAB PM3 On-line Help

MPLAB[®] IDE Quick Start Guide (DS51281)

Describes how to set up the MPLAB IDE software and use it to create projects and program devices.

MPLAB[®] IDE User's Guide (DS51519)

Comprehensive guide that describes installation and features of Microchip's MPLAB Integrated Development Environment (IDE).

MPASM[™] Assembler, MPLINK[™] Object Linker, MPLIB[™] Object Librarian User's Guide (DS33014)

Describes how to use the Microchip PICmicro MCU assembler (MPASM assembler), linker (MPLINK linker) and librarian (MPLIB librarian).

MPLAB IDE On-line Help

In-Circuit Serial Programming[™] (ICSP[™]) Guide (DS30277)

This document contains helpful design guidelines for successful ICSP programming. It includes application notes on hardware designs and the ICSP programming specifications.

THE MICROCHIP WEB SITE

Microchip provides on-line support via our web site at www.microchip.com. This web site is used as a means to make files and information easily available to customers. Accessible by using your favorite Internet browser, the web site contains the following information:

- **Product Support** – Data sheets and errata, application notes and sample programs, design resources, user's guides and hardware support documents, latest software releases and archived software
- **General Technical Support** – Frequently Asked Questions (FAQs), technical support requests, on-line discussion groups, Microchip consultant program member listing
- **Business of Microchip** – Product selector and ordering guides, latest Microchip press releases, listing of seminars and events, listings of Microchip sales offices, distributors and factory representatives

DEVELOPMENT SYSTEMS CUSTOMER CHANGE NOTIFICATION SERVICE

Microchip's customer notification service helps keep customers current on Microchip products. Subscribers will receive e-mail notification whenever there are changes, updates, revisions or errata related to a specified product family or development tool of interest.

To register, access the Microchip web site at www.microchip.com, click on Customer Change Notification and follow the registration instructions.

The Development Systems product group categories are:

- **Compilers** – The latest information on Microchip C compilers and other language tools. These include the MPLAB C18 and MPLAB C30 C compilers; MPASM and MPLAB ASM30 assemblers; MPLINK and MPLAB LINK30 object linkers; and MPLIB and MPLAB LIB30 object librarians.
- **Emulators** – The latest information on Microchip in-circuit emulators. This includes the MPLAB ICE 2000 and MPLAB ICE 4000.
- **In-Circuit Debuggers** – The latest information on the Microchip in-circuit debugger, MPLAB ICD 2.
- **MPLAB[®] IDE** – The latest information on Microchip MPLAB IDE, the Windows[®] Integrated Development Environment for development systems tools. This list is focused on MPLAB IDE, MPLAB SIM simulator, MPLAB IDE Project Manager and general editing and debugging features.
- **Programmers** – The latest information on Microchip programmers. These include the MPLAB PM3 and PRO MATE[®] II device programmers and the PICSTART[®] Plus and PICKit[™] 1 development programmers.

CUSTOMER SUPPORT

Users of Microchip products can receive assistance through several channels:

- Distributor or Representative
- Local Sales Office
- Field Application Engineer (FAE)
- Technical Support

Customers should contact their distributor, representative or field application engineer (FAE) for support. Local sales offices are also available to help customers. A listing of sales offices and locations is included in the back of this document.

Technical support is available through the web site at: <http://support.microchip.com>

Chapter 1. MPLAB PM3 Overview

1.1 INTRODUCTION

This chapter presents an overview of the features and requirements of MPLAB PM3. Topics covered in this chapter:

- What is MPLAB PM3?
- What MPLAB PM3 Does
- MPLAB PM3 System Components
- MPLAB PM3 CE Compliance
- How MPLAB PM3 Helps You
- MPLAB PM3 Operating with a PC
- MPLAB PM3 Operating without a PC (Stand-alone)
- MPLAB Integrated Development Environment
- MPLAB Development Tools

1.2 WHAT IS MPLAB PM3?

MPLAB PM3 is a Microchip microcontroller device programmer. Through interchangeable programming socket modules, MPLAB PM3 enables you to quickly and easily program the entire line of Microchip microcontroller devices.

MPLAB PM3 may be used with MPLAB IDE running under supported Windows Operating Systems (OS's) (see "Readme for MPLAB PM3.txt" file for support list) or as a stand-alone programmer.

See "Recommended Reading" in the "**Preface**" for more information.

1.3 WHAT MPLAB PM3 DOES

MPLAB PM3 can be set up on the serial (COM 1-4) or USB communications port on your PC. With MPLAB PM3 you can perform the following operations:

- Program memory, Configuration bits, EEPROM data memory, ID locations and calibration data into devices.
- Program devices using ICSP™ (In-Circuit Serial Programming™) on the target board and user GO, PASS and FAIL signals to interface with MPLAB PM3.
- Verify that microcontrollers are blank.
- Verify that code in the target microcontroller matches your firmware.
- Read code from an unprotected microcontroller into MPLAB IDE's program memory window for debugging and programming into other devices.
- Program unique serialized ID numbers into your firmware using Serial Quick Turn Programming (SQTPSM) files.
- Store environments on an MPLAB PM3 Card.

MPLAB® PM3 User's Guide

1.4 MPLAB PM3 SYSTEM COMPONENTS

The MPLAB PM3 device programmer system consists of the following:

- MPLAB PM3 device programmer (see Figure 1-1)
- Module sockets

Note: A complete line of socket modules is available. The socket modules may be ordered separately for the devices that will be programmed.

- RS-232 Interface cable to connect to any standard PC serial port
- USB Interface cable to connect to any standard PC USB port
- ICSP cable
- Power supply
- MPLAB IDE software – an Integrated Development Environment including a text editor, project manager and simulator for debugging. Also included are the MPASM assembler, MPLINK object linker and MPLIB object librarian.

FIGURE 1-1: MPLAB® PM3 DEVICE PROGRAMMER



1.5 MPLAB PM3 CE COMPLIANCE

The MPLAB PM3 device programmer is designed, tested and certified to meet the Electromagnetic Compatibility requirements known as the CE compliance directives. These standards, set by the European Union (EU) countries, include limiting radiated emission, reducing susceptibility to radiated emission and reducing susceptibility to Electrostatic Discharge (ESD).

1.6 HOW MPLAB PM3 HELPS YOU

With the MPLAB PM3 device programmer, you can program Microchip devices from a PC Host, or you can use the device programmer as a stand-alone unit.

- MPLAB PM3 is easy to use and flexible in programming Microchip devices and package types.
- MPLAB PM3 will expand to support future Microchip devices always providing the latest programming algorithms to support Microchip PIC[®] microcontroller devices and other Microchip parts, via the Microchip web site (<http://www.microchip.com>).
- With an optional MPLAB PM3 Card inserted, you can store and transport device settings for programming.

1.7 MPLAB PM3 OPERATING WITH A PC

Using MPLAB Integrated Development System (IDE) as the interface, MPLAB PM3 becomes another tool in MPLAB IDE, allowing you to quickly compile, test and debug your firmware, then download it into MPLAB PM3 to be programmed into your device.

1.8 MPLAB PM3 OPERATING WITHOUT A PC (STAND-ALONE)

Without a PC connection to MPLAB PM3, the unit operates as a stand-alone device programmer. However, a PC connection is required for operating system updates. The main programmer features of MPLAB PM3 are available, including Read, Program and Verify.

1.9 MPLAB INTEGRATED DEVELOPMENT ENVIRONMENT

The MPLAB IDE desktop provides an environment for developing and debugging your application. MPLAB PM3 is integrated into MPLAB IDE, but you do not need MPLAB IDE to use MPLAB PM3.

This document covers the basic setup and operation of the MPLAB PM3 device programmer, but it does not cover all functions of MPLAB IDE. Read the MPLAB IDE documentation to get a full understanding of the features and debug capabilities of MPLAB IDE.

1.10 MPLAB DEVELOPMENT TOOLS

MPLAB IDE integrates several tools to provide a complete development environment.

- **MPLAB Project Manager**

The Project Manager is used to create a project and work with the specific files related to the project. When using a project, source code is rebuilt and downloaded to the simulator or emulator with a single mouse click.

- **MPLAB Editor**

The MPLAB Editor is used to create and edit text files such as source files, code and linker script files.

- **MPLAB SIM Simulator**

The software simulator models the instruction execution and I/O of the PICmicro MCUs.

- **MPLAB ICE Emulator**

The MPLAB ICE emulator uses hardware to emulate PICmicro MCUs in real time, either with or without a target system.

- **MPASM Universal Assembler/MPLINK Relocatable Linker/MPLIB Librarian**

The MPASM assembler allows source code to be assembled without leaving MPLAB IDE. MPLINK linker creates the final application by linking relocatable modules from MPASM assembler, MPLAB C17 and MPLAB C18. MPLIB librarian manages custom libraries for maximum code reuse.

- **MPLAB C18 and MPLAB C30 C Compilers**

The MPLAB C18 and MPLAB C30 C Compilers provide ANSI-based high-level source code solutions. Complex projects can use a combination of C and assembly source files to obtain the maximum benefits of speed and maintainability.

- **MPLAB PM3, PRO MATE II and PICSTART Plus Programmers**

Develop code with the simulator or an emulator, assemble or compile it, then use one of these tools to program devices. This can all be accomplished with MPLAB IDE.

- **Third Party Tools**

Many other companies have development tools for Microchip products that work with MPLAB IDE. Consult the Microchip web site for additional information.

Chapter 2. Installing MPLAB PM3

2.1 INTRODUCTION

This chapter describes how to install MPLAB PM3 hardware and software. Topics covered in this chapter include:

- Installing MPLAB PM3 Software
- Installing MPLAB PM3 Hardware
- Powering Up MPLAB PM3
- Configuring MPLAB IDE for Use with MPLAB PM3

2.2 INSTALLING MPLAB PM3 SOFTWARE

MPLAB PM3 hardware requires the following software support if you are using a PC running Windows:

- MPLAB IDE software

<p>Note: There are alternative command-line programs for MPLAB PM3 control, also installed with MPLAB IDE, named PM3CMD and Visual PROCMD.</p>

- USB communications driver

2.2.1 MPLAB IDE Software Installation

The MPLAB IDE software should be installed by following the instructions in the “MPLAB® IDE Quick Start Guide” (DS51281). A brief summary of this procedure is discussed next.

- For a CD-ROM:
 - Insert the MPLAB IDE CD into the CD-ROM drive.
 - Follow the on-screen instructions to install the MPLAB IDE software.
- For the Microchip Website:
 - Go to www.microchip.com and follow the links to the Development Tools page.
 - Click the links to the latest MPLAB IDE release and download.

2.2.2 USB Driver Installation

NOTICE

Do not allow the Windows OS to pick a USB driver. MPLAB PM3 will not work with this driver. You must follow the procedure specified at MPLAB IDE software installation to set up the USB driver or to fix an improper driver installation.

Install MPLAB IDE first. The USB driver installation instructions will pop up at the end of MPLAB IDE installation. Follow those instructions to install the USB driver.

The instructions are in the MPLAB IDE installation directory under:

MPLAB PM3\Drivers\instr.htm

where *instr.htm* depends on your Personal Computer (PC) OS:

- ddpm398.htm – Windows 98
- ddpm3me.htm – Windows ME
- ddpm3.htm – Windows 2000/XP

2.3 INSTALLING MPLAB PM3 HARDWARE

IMPORTANT: Do not allow the Windows OS to pick a USB driver. Follow the procedure specified in **Section 2.2.2 “USB Driver Installation”**.

The MPLAB PM3 hardware is simple to set up:

- If you are using MPLAB IDE:
 - Attach the communications cable.
 - Connect the power supply to MPLAB PM3.
 - Install the socket module (or attach the ICSP cable).
- If you are using MPLAB PM3 in Stand-Alone mode:
 - Connect the power supply to MPLAB PM3.
 - Install the socket module or attach the ICSP cable.
- If you are using the MPLAB PM3 Card in MPLAB PM3:
 - Insert the MPLAB PM3 Card into the SD-MMC port on the back of the programmer.

2.3.1 Installing the Communications Cable

MPLAB PM3 provides communications with the host PC via an RS-232 9-pin D type connector or a USB connector. See Figure 2-1 for communication port locations.

MPLAB PM3 is supplied with two 6-foot data cables: one with DB-9 connectors and one with USB connectors. All lines on the serial cable are wired straight through. The serial cable is NOT a null modem cable.

FIGURE 2-1: BACK VIEW OF MPLAB[®] PM3

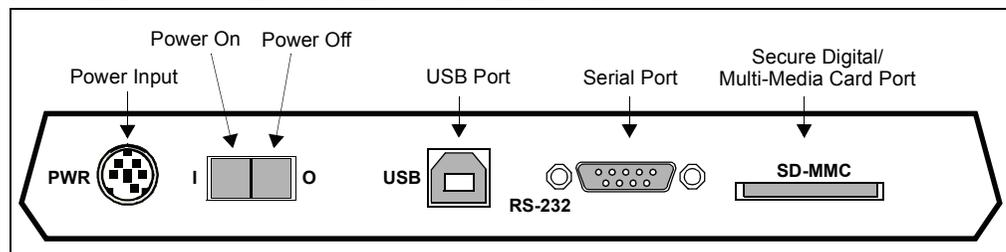

2.3.1.1 FOR USB COMMUNICATIONS

- Connect one end of the USB cable to a USB port on your PC.
- Connect the cable from the PC USB port to the corresponding USB connector on the back of MPLAB PM3.

Note: If you are using USB and a “New Hardware Detected” notice appears on your PC, you must follow the directions on installing the proper driver or your MPLAB PM3 will not work.

2.3.1.2 FOR RS-232 COMMUNICATIONS

NOTICE

IMPORTANT: Set the COM port FIFO buffers off, the Flow Control to “Hardware” and Baud Rate to 57600. You will need to reboot your PC for these settings to take effect. See Section B.5.2.5 “Manually Setting Up The Port” for more information.

- Connect one end of the RS-232 cable to an available COM port on your PC. Check your PC setup to see which communications port is available.
- Connect the cable from the PC COM port to corresponding RS-232 connector on the back of MPLAB PM3. For more on serial connections, see **Section A.2 “Connecting to a PC via the Serial Port”**.

2.3.2 Installing the Power Supply

MPLAB PM3 comes with a proprietary external power supply.

1. Make sure that the power switch on the back of the unit is in the OFF position (see Figure 2-1).
2. Plug the power supply into a power socket and connect the power supply cable to the unit.

2.3.3 Installing a Socket Module or ICSP Cable

Socket modules are sold separately. MPLAB PM3 comes with an 18-inch ICSP cable for ICSP programming. See Figure 2-2 for location of socket module connectors and ICSP connector.

FIGURE 2-2: TOP VIEW OF MPLAB® PM3

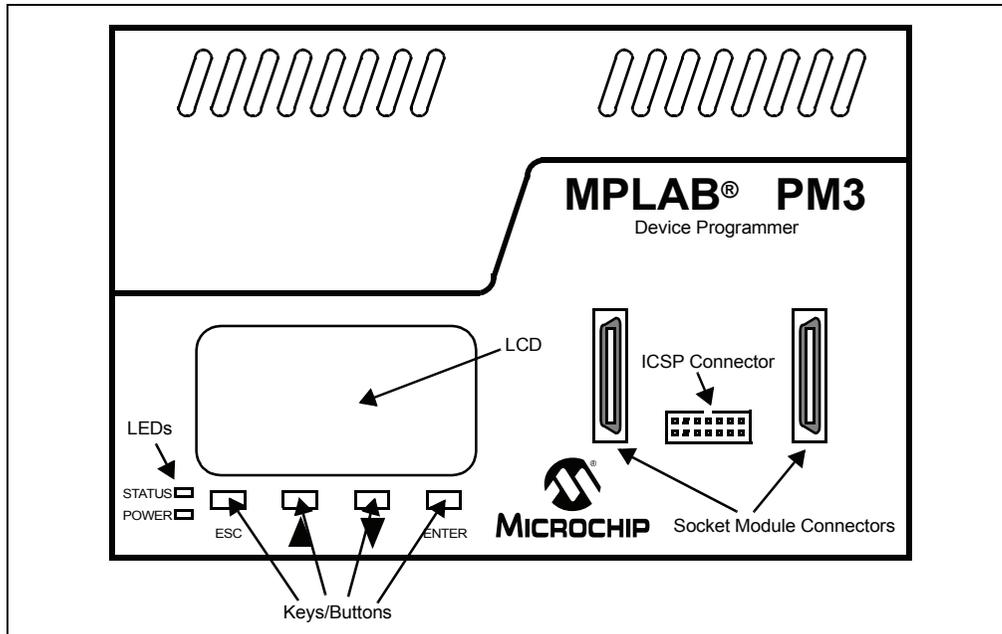

2.3.3.1 SOCKET MODULE INSTALLATION

Socket modules are available to accommodate each device package. The “*Product Selector Guide*” (DS00148) lists Microchip’s devices, tools and socket modules. The “*Development System Ordering Guide*” (DS30177) describes the available socket modules. Also, the *Readme for MPLAB PM3* file lists socket module support for each device.

Note: MPLAB PM3 allows hot swapping of socket modules. If the status LED is not lit, sockets can be replaced.

2.3.3.1.1 For MPLAB PM3 Socket Modules

1. Align the connectors on the socket module with the connectors on MPLAB PM3 (Figure 2-2).
2. Push the socket module down evenly mating the connectors.

It is always a good practice to insert a known blank device and do a Blank Check whenever the socket module is changed.

2.3.3.1.2 For PRO MATE II Socket Modules

Note 1: In order to use PRO MATE II socket modules with MPLAB PM3, you must obtain an AC164350 adapter kit. See the “*Development System Ordering Guide*” (DS30177).

- 2: The PRO MATE II ICSP socket module is not supported by MPLAB PM3. An 18-inch ICSP cable is included with MPLAB PM3, eliminating the need for an ICSP socket.

1. Align the connectors on the adapter with the connectors on MPLAB PM3.
2. Push the adapter down evenly mating the connectors.
3. Align the socket module with the adapter on MPLAB PM3.
4. Tighten the two socket module thumb screws evenly and simultaneously. Avoid over tightening; they should be finger-tight only.

Note: The gold connector strips on the PRO MATE II socket module are relatively fragile. Avoid touching them with the socket module screws and avoid over-tightening the screws.

It is always a good practice to insert a known blank device and do a Blank Check whenever the socket module is changed.

2.3.3.2 ICSP CABLE INSTALLATION

1. Connect the ICSP cable connector to the ICSP socket on MPLAB PM3 (Figure 2-2).
2. Leave the individual leads unconnected at this time.

2.3.3.3 MPLAB PM3 CARD INSERTION

1. Align the MPLAB PM3 Card with the SD-MMC slot on the back of the MPLAB PM3 programmer, and insert the notched corner end of the card into the slot. The card is keyed so that it only goes in one way.
2. Push the card into the slot.
3. To remove the card, push in to eject.

2.4 POWERING UP MPLAB PM3

Once you have connected the hardware and installed the software, you are ready to turn on MPLAB PM3. Turn the power switch on the side of MPLAB PM3 to I (ON) (refer back to Figure 2-1).

Note: MPLAB PM3 automatically performs a self-test ensuring the programmer is functional. No calibration is required.

If any portion of the self-test fails, MPLAB PM3 will display the corrective course of action on the LCD panel. For normal start-up, the MPLAB PM3 will beep once. See **Section B.7 “Error Messages – LCD”** for information on beep codes and LCD error messages. MPLAB IDE will provide further information to help you debug the issue.

On a successful power-up, you should see the following types of messages appear on the LCD panel on the front of MPLAB PM3:

- MPLAB PM3 splash screen
- Version numbers and copyright dates
- MPLAB PM3 menu

At this point, you are ready to use MPLAB PM3. If you are going to use MPLAB PM3 with MPLAB IDE (Windows), please refer to **Chapter 4. “Using MPLAB PM3 with MPLAB IDE”**. If you are going to use MPLAB PM3 in Stand-Alone mode, please refer to **Chapter 5. “Using MPLAB PM3 in Stand-Alone Mode”**. If you are using the MPLAB PM3 Card with either MPLAB IDE or in Stand-Alone mode, also refer to **Chapter 6. “Using the MPLAB PM3 Card”**

2.4.1 Indicator Lights and Buzzer

Two indicator lights (LEDs) are located on the front of the programmer. A buzzer, for audio indication, is incorporated into the programmer as well.

TABLE 2-1: STATUS LED INDICATIONS

LED	Condition
Red	Booting up, Programming Failed, Other Error
Orange	Working/Busy
Green	Programming Passed

TABLE 2-2: POWER LED

LED	Condition
On	Programmer powered
Off	Programmer not powered

2.4.2 Powering Down MPLAB PM3

Turn the power switch on the back of MPLAB PM3 to "OFF".

2.5 CONFIGURING MPLAB IDE FOR USE WITH MPLAB PM3

2.5.1 Starting MPLAB IDE

Once MPLAB IDE is installed on your PC, from the Start menu, select All Programs> Microchip MPLAB IDE>MPLAB IDE.

The MPLAB IDE desktop should look similar to Figure 2-3.

FIGURE 2-3: MPLAB[®] IDE DESKTOP

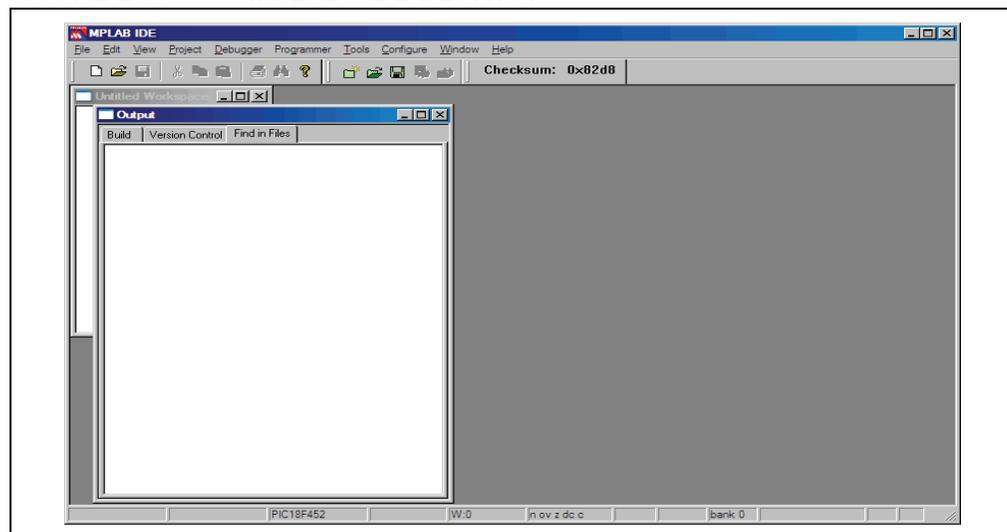

2.5.2 Selecting MPLAB PM3 as the Programmer

In addition to MPLAB PM3, the PRO MATE II and PICSTART Plus device programmers are supported under MPLAB IDE. However, only one programmer can be used at a time.

Select *Programmer>Select Programmer>MPLAB PM3* to select MPLAB PM3 from the list of available programmers (Figure 2-4). After MPLAB PM3 is selected:

- The Programmer menu changes to include the MPLAB PM3 Programmer Menu and Settings.
- The MPLAB PM3 Toolbar is revealed.
- The name of the programmer appears on the status bar.

FIGURE 2-4: SELECT PROGRAMMER MENU

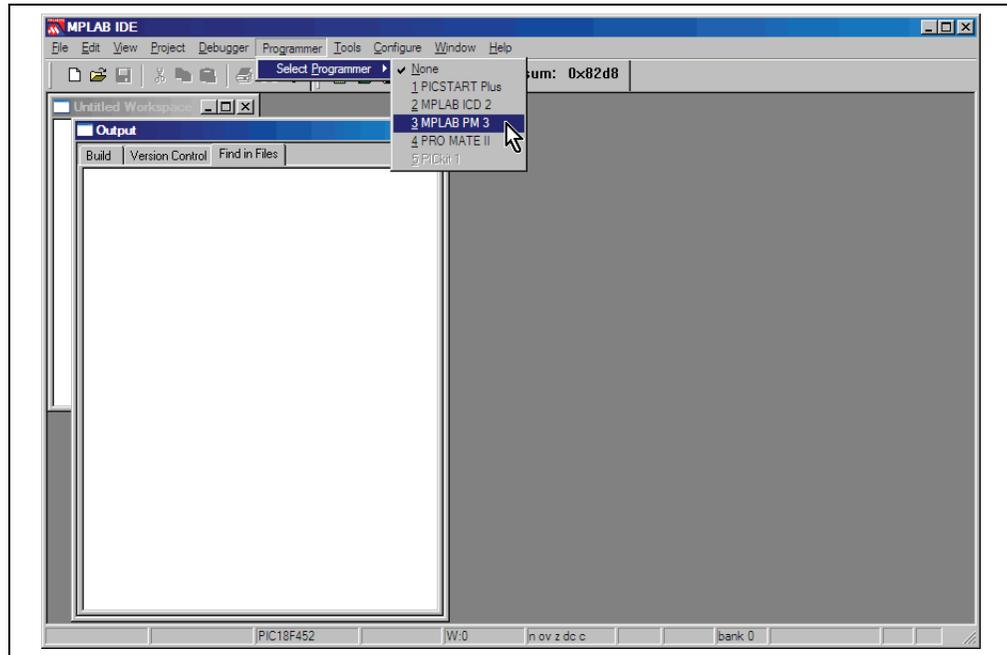

2.5.3 Setting Up the Communications Port

You can set up MPLAB PM3 to communicate with MPLAB IDE through one of the serial COM ports (1-4) or USB.

2.5.3.1 SERIAL COMMUNICATIONS

From the MPLAB Programmer menu, select *Programmer>Settings* and click on the **Communications** tab. A dialog similar to the one shown in Figure 2-5 will display.

FIGURE 2-5: COMMUNICATIONS PORT SETUP DIALOG

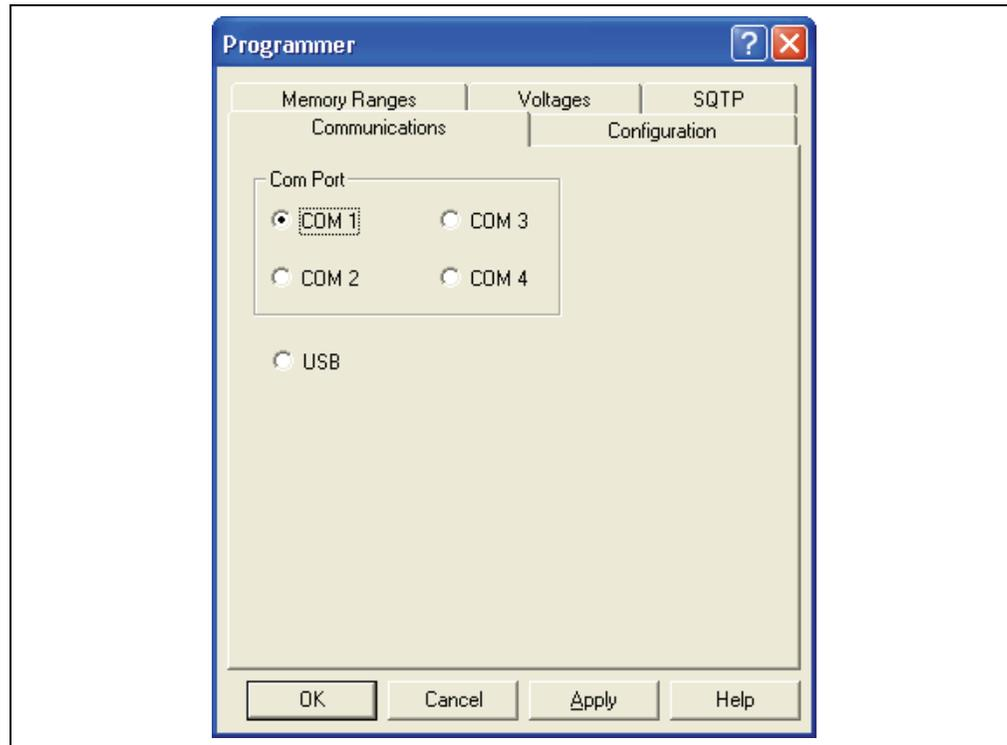

The Communications Port Setup dialog shows the possible PC serial and USB communication ports. Click **OK** to set the options or **Cancel** to ignore the changes and close the dialog.

2.5.3.2 USB COMMUNICATIONS

To use USB communications between the PC and the MPLAB PM3 device programmer, select the USB port (Figure 2-6). Click **OK**.



FIGURE 2-6: USB PORT

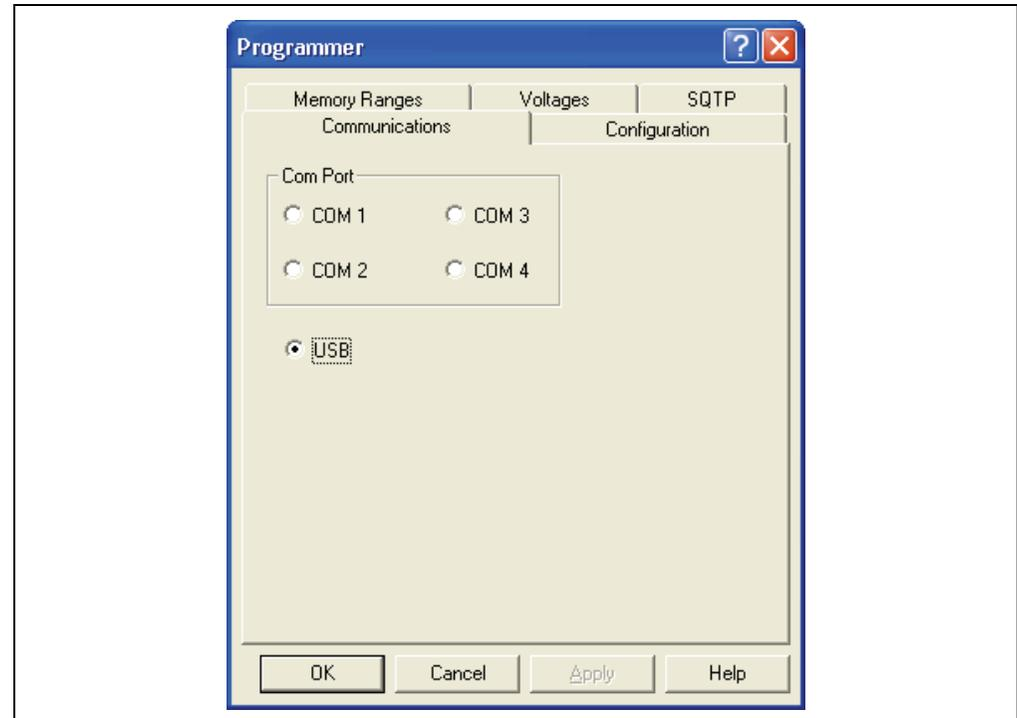

To make sure the port is set up properly, follow the instructions in the “For USB Communications” subsection in **Section 2.3.1 “Installing the Communications Cable”**.

2.5.4 Selecting a Device in MPLAB IDE

Chose *Configure>Select Device* to select the device you wish to program from the list of available devices (Figure 2-7). When you select a device, indicators next to the Microchip Tools names show the level of support for that device:

- Green – supports the device
- Yellow – limited (advance) support
- Red – no support.

If the selected device is supported by MPLAB PM3, click **OK**.

FIGURE 2-7: SELECT DEVICE DIALOG

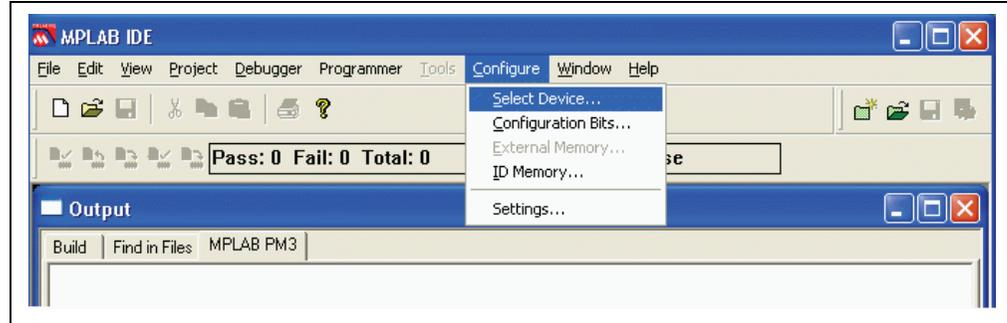

2.5.5 Enabling MPLAB PM3

To enable MPLAB PM3, select *Programmer>Enable Programmer* (Figure 2-8). The MPLAB PM3 toolbar will appear when the programmer is enabled. See **Chapter 7. “MPLAB PM3 – MPLAB IDE Reference”** for more reference information on the MPLAB PM3 programmer. The MPLAB PM3 Card is available from the Programmer menu only if you have the MPLAB PM3 Card inserted in the MPLAB PM3 programmer.

MPLAB IDE may warn you that your programmer OS Suite is out of date. If you choose, MPLAB IDE will automatically update the necessary files at these warnings.

FIGURE 2-8: ENABLE PROGRAMMER

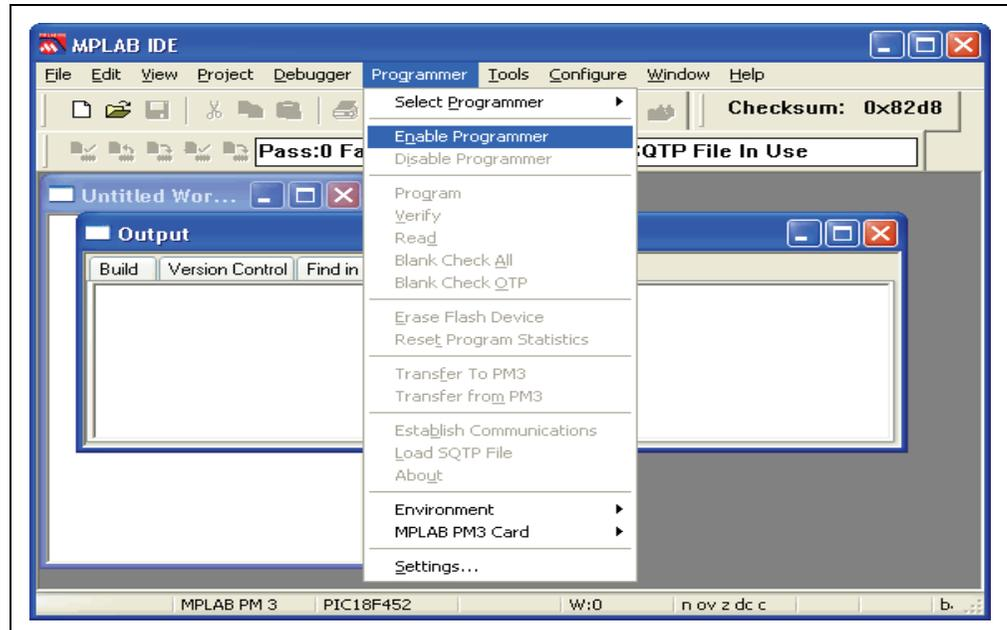

If MPLAB PM3 is not found on the selected port, the Communications Error dialog (Figure 2-9) will appear.

FIGURE 2-9: COMMUNICATIONS ERROR DIALOG

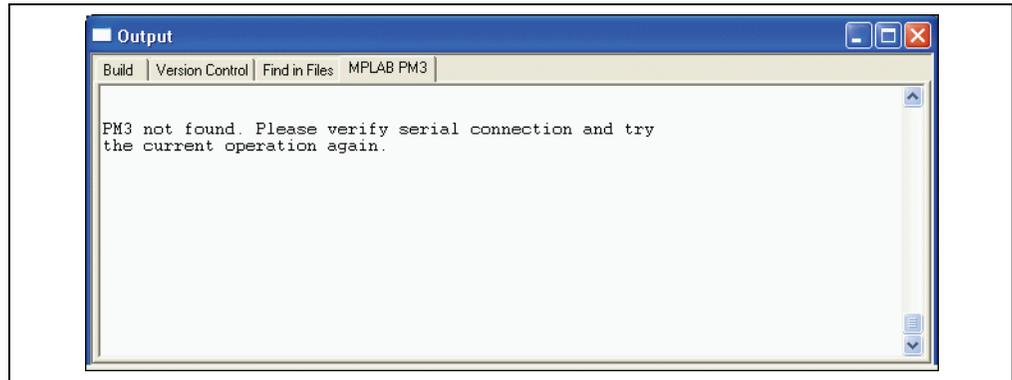

If you cannot establish communications between the PC and MPLAB PM3, please make sure you have installed the hardware and software correctly. If you still cannot establish communications between the PC and MPLAB PM3, refer to **Appendix B. "Troubleshooting"**.

If you have been using another programmer (e.g., PICSTART Plus), the MPLAB PM3 menu may be unavailable. From the Programmer menu, select Programmer> Select Programmer to bring up the Select Programmer dialog and choose MPLAB PM3 from the list. The MPLAB PM3 menu will appear on the menu bar.

2.5.6 Inserting a Device into MPLAB PM3

If you are using a socket module, insert the device to be programmed into the MPLAB PM3 socket. Position pin one to be top justified in the socket. Secure the device by pushing down the silver lever on the socket or closing the clamshell.

MPLAB[®] PM3 User's Guide

NOTES:

Chapter 3. Tutorial

3.1 INTRODUCTION

The tutorial in this chapter leads you through the steps involved in programming the PIC18F452 PICmicro device using MPLAB IDE Project Wizard.

3.2 BEFORE YOU BEGIN

Before you can begin this tutorial, you must:

1. Install the MPLAB IDE software. See **Section 2.2 “Installing MPLAB PM3 Software”**.
2. Install the MPLAB PM3 hardware. See **Section 2.3 “Installing MPLAB PM3 Hardware”**.
3. Make sure you have read and completed all the instructions in **Section 2.4 “Powering Up MPLAB PM3”** and **Section 2.5 “Configuring MPLAB IDE for Use with MPLAB PM3”**.
4. Make sure that your PC and MPLAB PM3 are communicating and the MPLAB PM3 menu appears on the MPLAB IDE menu before you begin this tutorial.

3.3 PROGRAMMING OVERVIEW

Programming a device involves the following steps:

- Selecting the Device
- Creating the Project
- Setting Up Language Tools
- Naming the Project
- Adding Files to the Project
- Building the Initial Project
- Creating Code
- Building the Project
- Enabling MPLAB PM3
- Programming the Device
- Verifying the Programming

3.4 SELECTING THE DEVICE

If you have not already selected the device in MPLAB IDE, do so by selecting *Configure>Select Device* to open the Select Device dialog (Figure 3-1) and select the PIC18F452 device.

Under Microchip Programmer Tool Support, verify that this device is supported (green light) by MPLAB PM3. Click **OK**.

FIGURE 3-1: SELECTING THE DEVICE

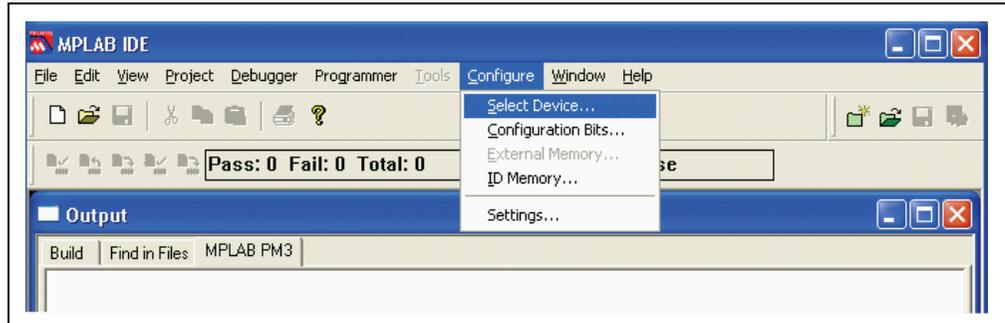

3.5 CREATING THE PROJECT

In order to program the device, you'll need a hex file. In this example, we'll create a project using the Project Wizard. We will use a single assembly file for this project and a linker script. Choose the *Project>Project Wizard*.

FIGURE 3-2: PROJECT WIZARD WELCOME SCREEN

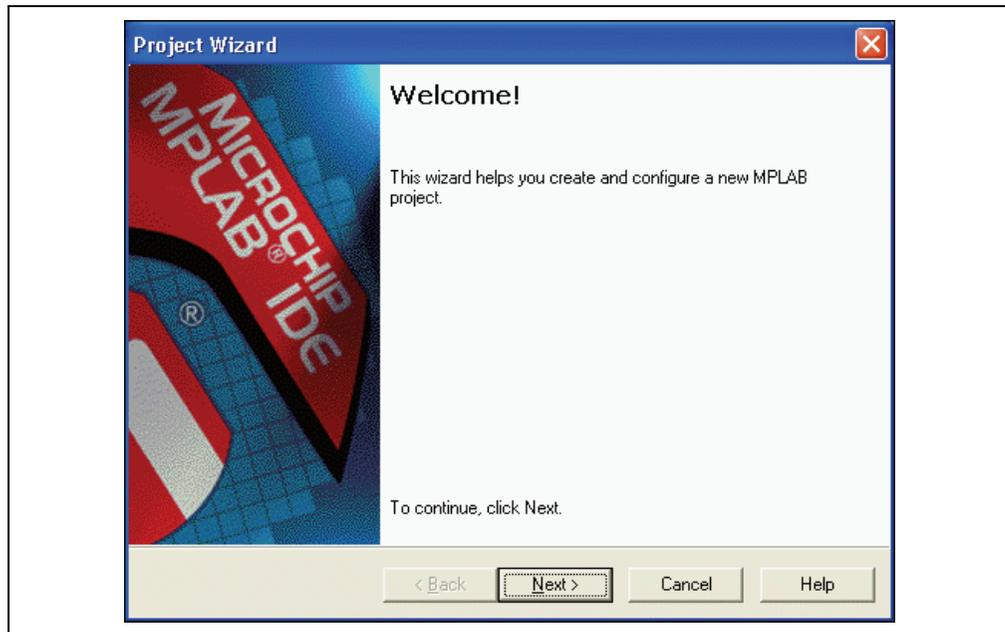

Click on **Next>** to advance to the next dialog in the Project Wizard.

The next dialog allows you to select the device, which we've already done. Make sure that it says PIC18F452. If it does not, select the PIC18F452 from the drop down menu. Click **Next>**.

FIGURE 3-3: PROJECT WIZARD – SELECT DEVICE

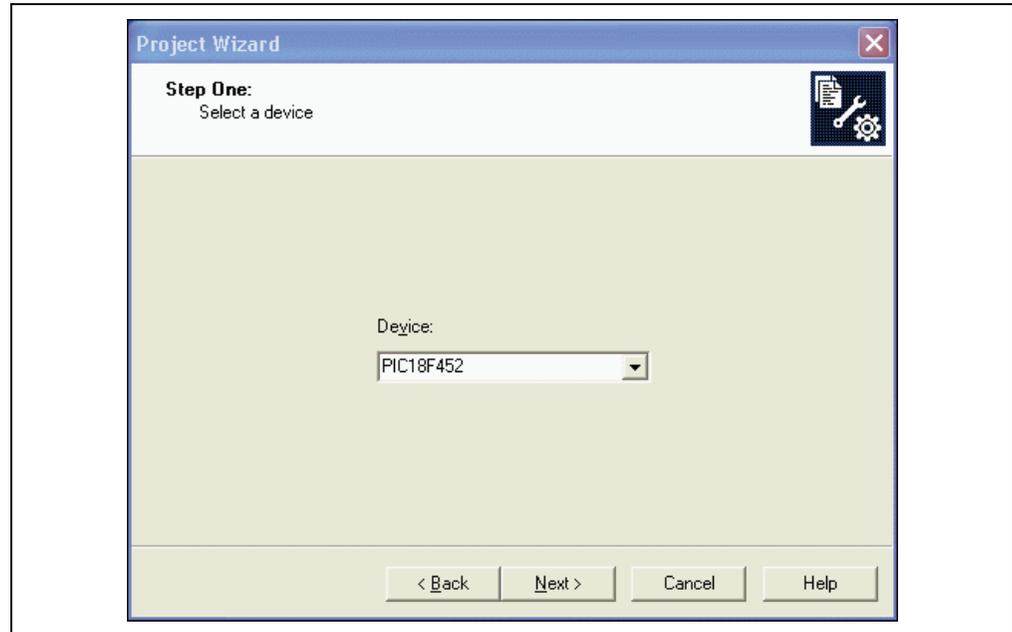

3.6 SETTING UP LANGUAGE TOOLS

Step Two of the Project Wizard sets up the language tools that are used with this project. Select "Microchip MPASM Toolsuite" in the Active Toolsuite list box. Then "MPASM" and "MPLINK" should be visible in the Toolsuite Contents box. Click on each one to see its location. If MPLAB IDE was installed into the default directory, the MPASM assembler executable will be:

```
C:\Program Files\Microchip\MPASM Suite\MPAsmWin.exe
```

and the MPLINK linker executable will be:

```
C:\Program Files\Microchip\MPASM Suite\MPLink.exe
```

If these do not show up correctly, use the **Browse** button to set them to the proper files in the MPLAB IDE subfolders.

FIGURE 3-4: PROJECT WIZARD – SELECT LANGUAGE TOOLS

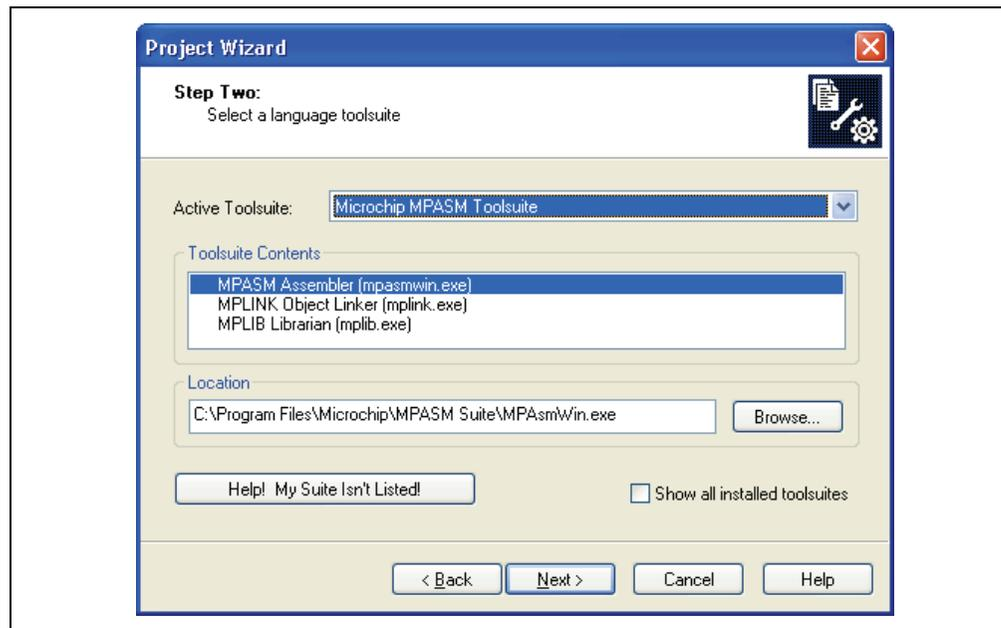

When you are finished, click **Next>**.

3.7 NAMING THE PROJECT

Step Three of the wizard allows you to name the project and put it into a folder. This sample project will be called `18F452Proj`. Using the **Browse** button, place the project in a folder on the C drive named `My Projects`. Click **Next>**.

FIGURE 3-5: PROJECT WIZARD – NAME PROJECT

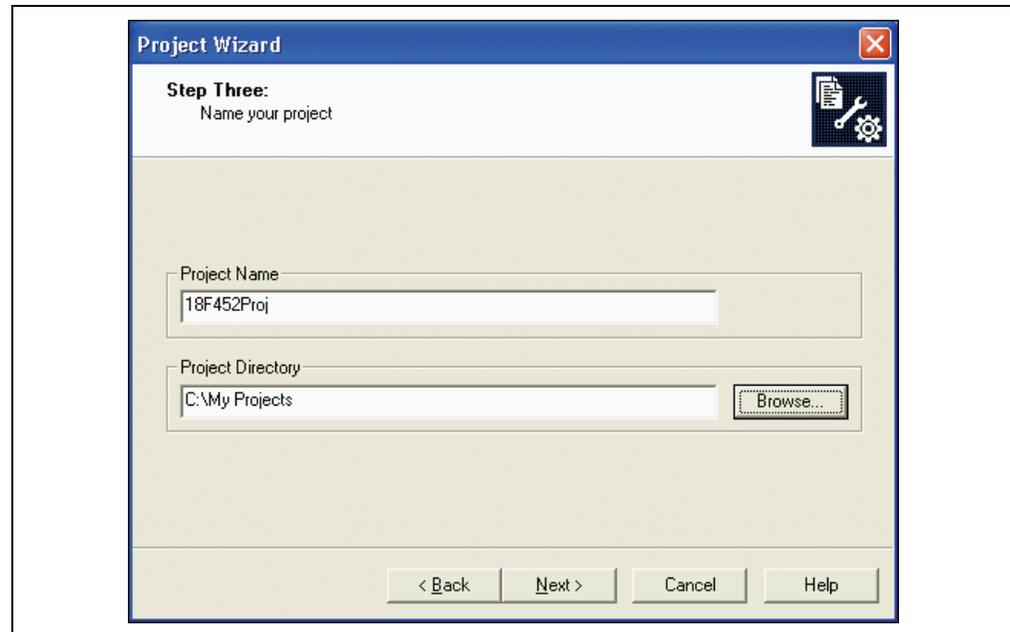

3.8 ADDING FILES TO THE PROJECT

Step Four of the Project Wizard allows file selection for the project. A source file has not yet been selected, so we will use an MPLAB IDE template file. The template files are simple files that can be used to start a project. They have the essential sections for any source file, and contain information that will help you write and organize your code. These files are in the `MPLAB IDE` folder, which by default is in the `Program Files` folder on the PC. There is one template file for each Microchip PICmicro MCU and dsPIC® DSC device.

Scroll to the `Program Files` folder on Drive C:, open it, and scroll down to the `Microchip` folder. Open the `Microchip` folder and scroll down to the `MPASM Suite` directory. Open the `MPASM Suite` directory and get a template from the `Object` folder in the `Template` folder, and choose the file named `f452tmpo.asm`.

If MPLAB IDE is installed in the default location, the full path to the file will be:

```
C:\Program Files\Microchip\MPASM Suite\TEMPLATE\Object\f452tmpo.asm
```

FIGURE 3-6: PROJECT WIZARD – SELECT TEMPLATE FILE

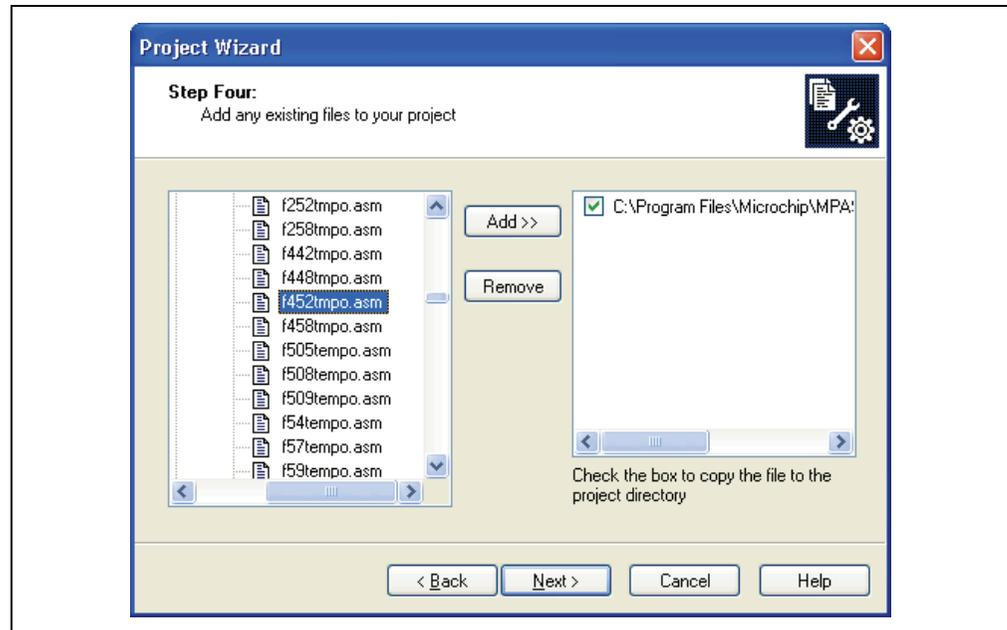

Press **Add>>** to move the file name to the right panel, and click on the check box at the start of the line with the file name to enable this file to be copied to our project directory.

Next, add the second file for our project, the linker script. There is a linker script for each device. These files define the memory configuration and register names for the various parts. The linker scripts are in the folder named LKR under the MPASM Suite folder. Use the file named 18F452.lkr The full path is:

C:\Program Files\Microchip\MPASM Suite\LKR\18F452.lkr

To copy this linker script into our project, click on the check box.

FIGURE 3-7: PROJECT WIZARD – SELECT LINKER SCRIPT

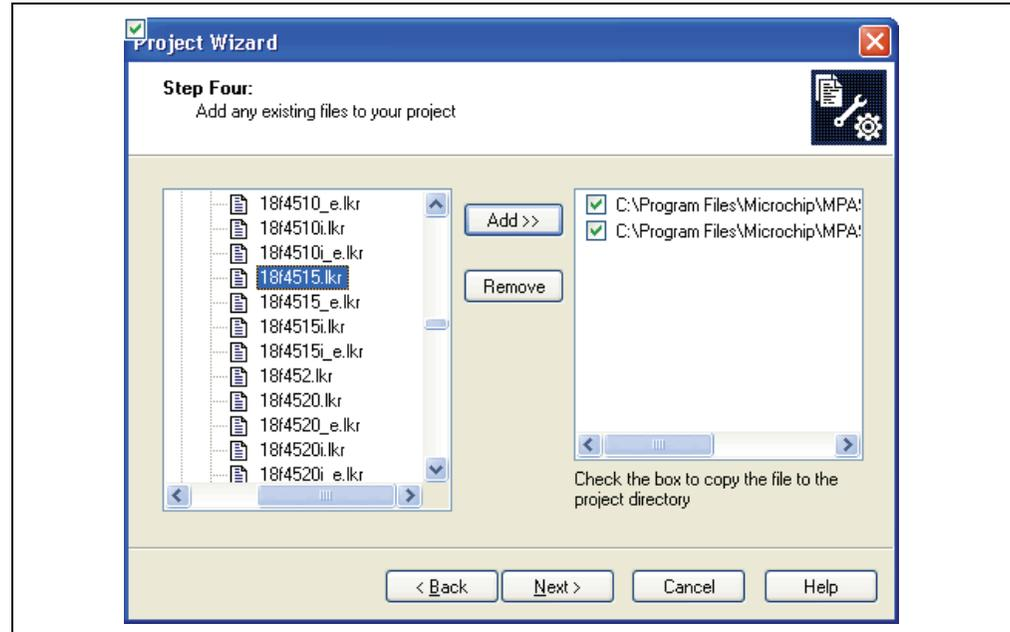

Make sure that your dialog looks like the picture above, with both check boxes checked, then press **Next>** to finish the Project Wizard.

The final screen of the Project Wizard is a summary showing the selected device, the toolsuite and the new project file name.

FIGURE 3-8: PROJECT WIZARD – SUMMARY

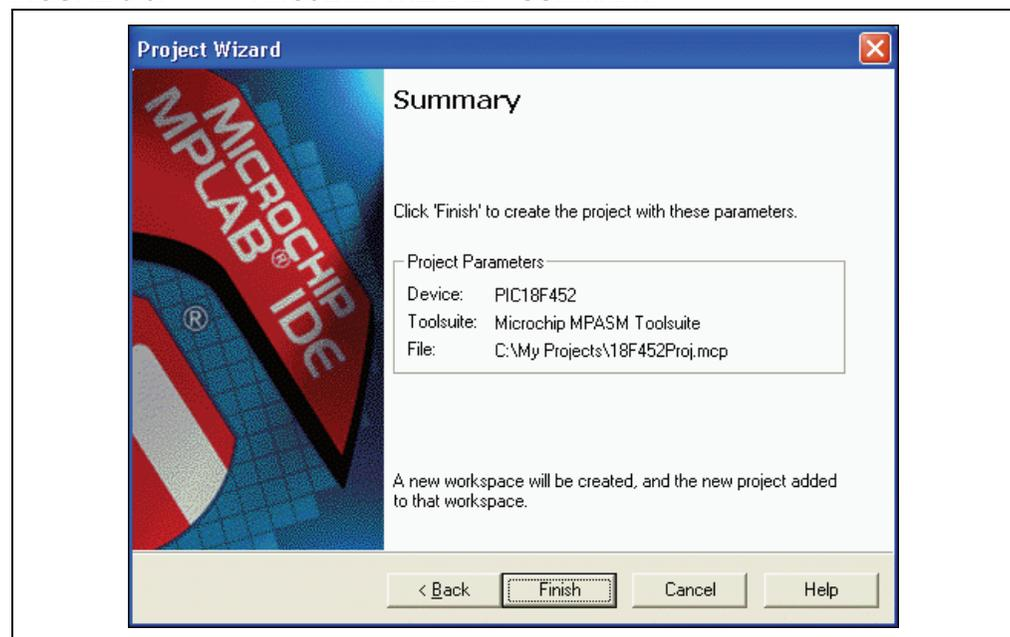

After pressing the **Finish** button, review the Project window on the MPLAB IDE desktop. It should look like Figure 3-9. If the Project window is not open, select View>Project.

FIGURE 3-9: PROJECT WINDOW

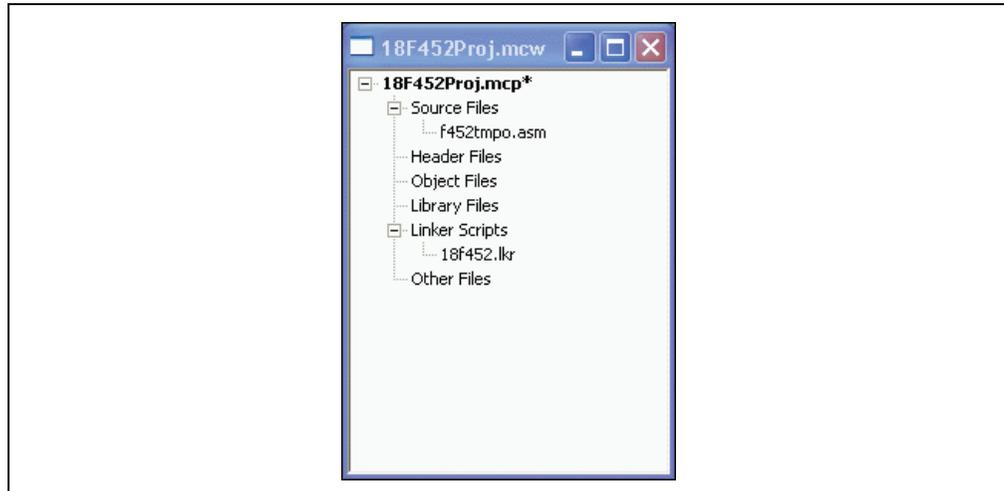

3.9 BUILDING THE INITIAL PROJECT

From the Project menu, we can assemble and link the current files. They don't have any of our code in them yet, but this ensures that the project is set up correctly.

Click back on the 18f452Proj.mcw window to make it the active window. Now, build the project by selecting Project>Build All. The Output window shows the result of the build process as shown in Figure 3-10.

FIGURE 3-10: INITIAL BUILD RESULTS WINDOW

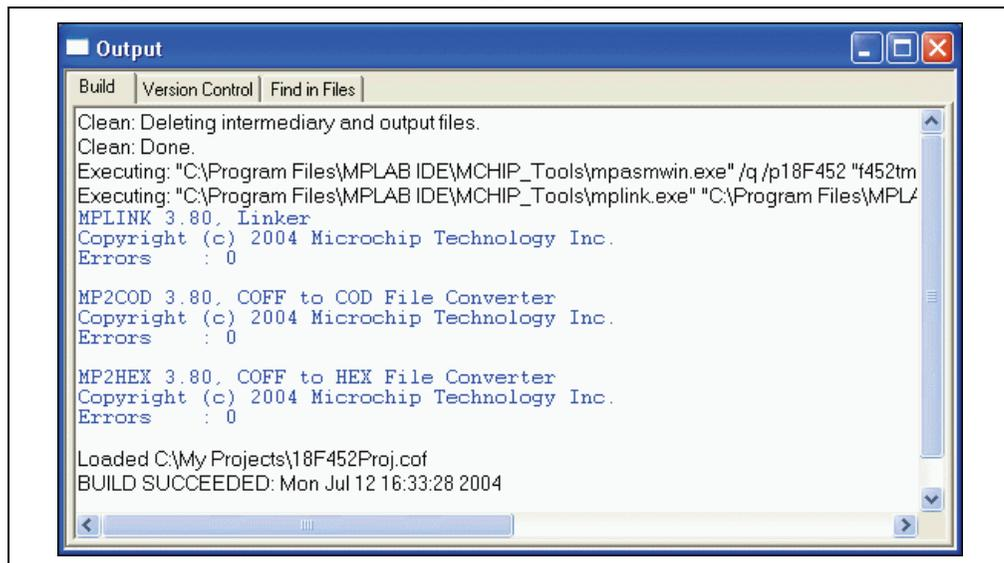

3.10 CREATING CODE

Open the template file in the project by double clicking on its name in the Project window (see Figure 3-11).

The file has some comments at the beginning, and this area can be used as a standard comment information header for the file. For now, you'll leave this as it is, but if this were a real project, you could put information about your design here.

FIGURE 3-11: TEMPLATE FILE

```

1  ;*****
2  ; This file is a basic template for creating relocatable assembly code for
3  ; a PIC18F452. Copy this file into your project directory and modify or
4  ; add to it as needed. Create a project with MPLINK as the language tool
5  ; for the hex file. Add this file and the 18F452.LKR file to the project.
6  ;
7  ; The PIC18FXXX architecture allows two interrupt configurations. This
8  ; template code is written for priority interrupt levels and the IPEN bit
9  ; in the RCON register must be set to enable priority levels. If IPEN is
10 ; left in its default zero state, only the interrupt vector at 0x008 will
11 ; be used and the WREG_TEMP, BSR_TEMP and STATUS_TEMP variables will not
12 ; be needed.
13 ;
14 ; Refer to the MPASM User's Guide for additional information on the
15 ; features of the assembler and linker.
16 ;
17 ; Refer to the PIC18FXXX2 Data Sheet for additional information on the
18 ; architecture and instruction set.
19 ;
20 ;*****
21 ;
22 ;   Filename:
23 ;   Date:
24 ;   File Version:

```

Scroll down to the bottom of the file.

The code in the first part of the file is for more advanced functions such as setting up interrupts and Configuration bits in a final application. These details can be ignored at this point with focus on writing the code. The new code will be placed in the file at the point after the symbol `Main` is defined.

FIGURE 3-12: TEMPLATE FILE – MAIN

```

139 ;*****
140 ;Start of main program
141 ; The main program code is placed here.
142
143 Main:
144
145 ;   *** main code goes here ***
146
147 ;*****
148 ;End of program
149
150
151     END
152

```

MPLAB® PM3 User's Guide

When any source file is opened, you are automatically in the editor. Type in this code:

Main:

```
    clrf  WREG
    movwf PORTC; clear PORTC
    movwf TRISC; configure PORTC as all outputs
```

Init

```
    clrf  COUNT
```

IncCount

```
    incf  COUNT
    movf  COUNT,W
    movwf PORTC; display COUNT on PORTC
```

```
    call Delay
```

```
    goto IncCount; infinite loop
```

Delay

```
    movlw 0x40; set outer delay loop
```

```
    movwf DVAR2
```

Delay0

```
    movlw 0xFF
```

```
    movwf DVAR; set inner delay loop
```

Delay1

```
    decfsz DVAR
```

```
    goto Delay1
```

```
    decfsz DVAR2
```

```
    goto Delay0
```

```
    return
```

The template file should now look like Figure 3-13.

FIGURE 3-13: TEMPLATE FILE – ADD CODE

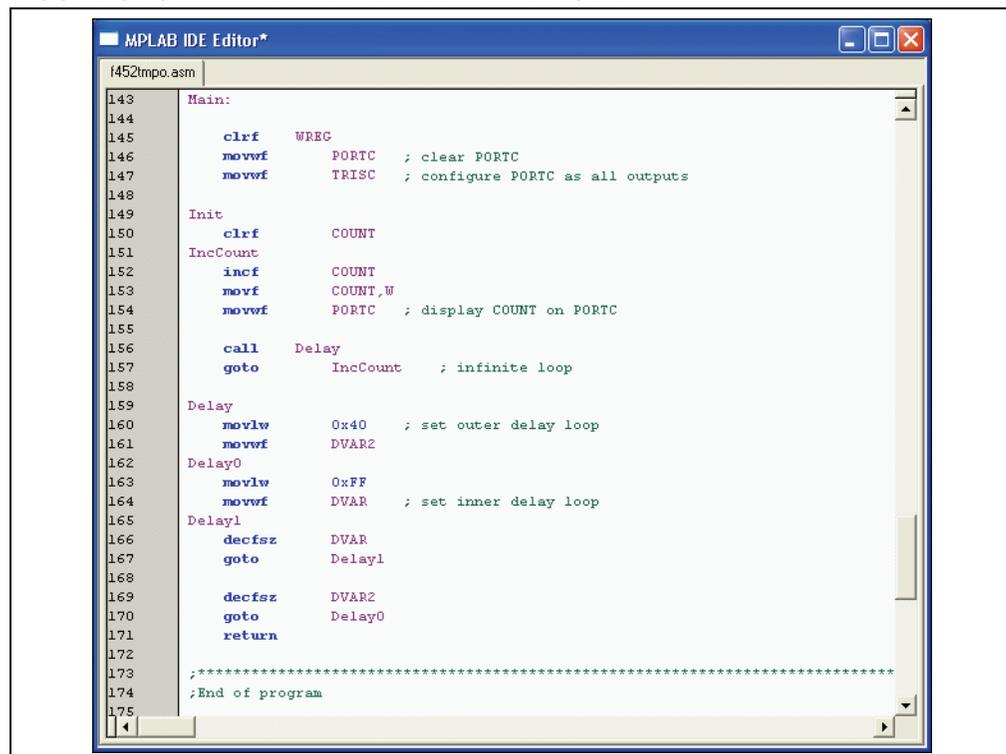

In this bit of code, we used three variables named COUNT, DVAR and DVAR2. These variables need to be defined in the template file in the UDATA section for uninitialized data. There are already three variables in this section of the template file, ours can be added at the end using the same format. Each variable is an 8-bit variable, so they only need to reserve 1 byte each.

FIGURE 3-14: TEMPLATE FILE – ADD VARIABLES

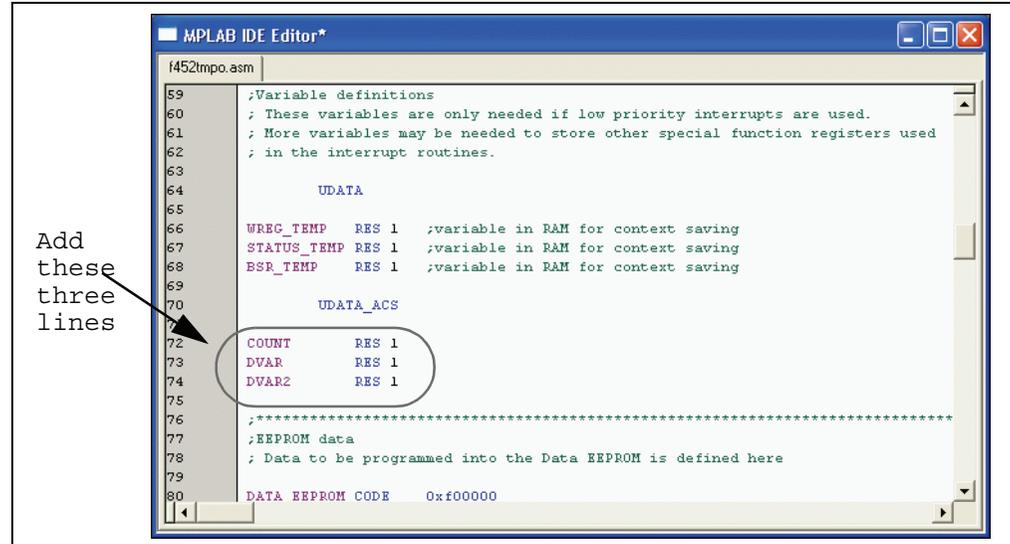

3.11 BUILDING THE PROJECT

Select *Project>Build All* to assemble and link the code. If the code assembled with no errors, the Output window will look like Figure 3-15.

FIGURE 3-15: BUILD OUTPUT WINDOW

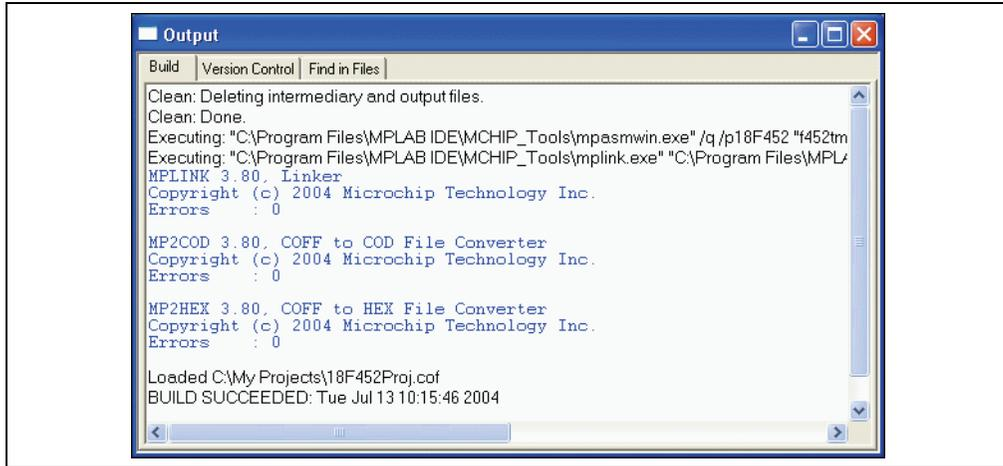

Save your project by selecting *File>Save Workspace*.

If these do not assemble and link successfully, check the following items and then build the project again:

- Check the spelling and format of the code entered in the Editor window. Make sure the new variables and the special function registers, TRISC and PORTC, are in upper case. If the assembler reported errors in the Output window, double click on the error and MPLAB IDE will open the corresponding line in the source code with a green arrow in the left margin of the source code window.
- Check that the correct assembler (MPASM assembler) and linker for PICmicro MCU devices is being used. Select *Project>Set Language Tool Locations*. Click on the plus boxes to expand the Microchip MPASM assembler toolsuite and its executables. Click MPASM Assembler (mpasmwin.exe) and review their location in the display. If the location is correct, click **Cancel**. If it is not, change it and then click **OK**. The default search paths can be empty.

Upon a successful build, the output file generated by the language tool will be loaded. This file contains the object code that can be programmed into a PICmicro MCU and debugging information so that source code can be debugged, and source variables can be viewed symbolically in Watch windows.

Now that you've built your project successfully, you can prepare for programming your device.

3.12 ENABLING MPLAB PM3

If you haven't already started the MPLAB PM3 device programmer, select *Programmer>Enable Programmer*. The MPLAB PM3 toolbar will appear when the programmer is enabled.

Select *View>Program Memory* and click on **Opcode Hex** at the bottom of the window (see Figure 3-16) to view the hex code you've just built. You can resize or move the Program Memory window on your display. You may wish to close the Build Results window.

FIGURE 3-16: VIEWING PROGRAM MEMORY

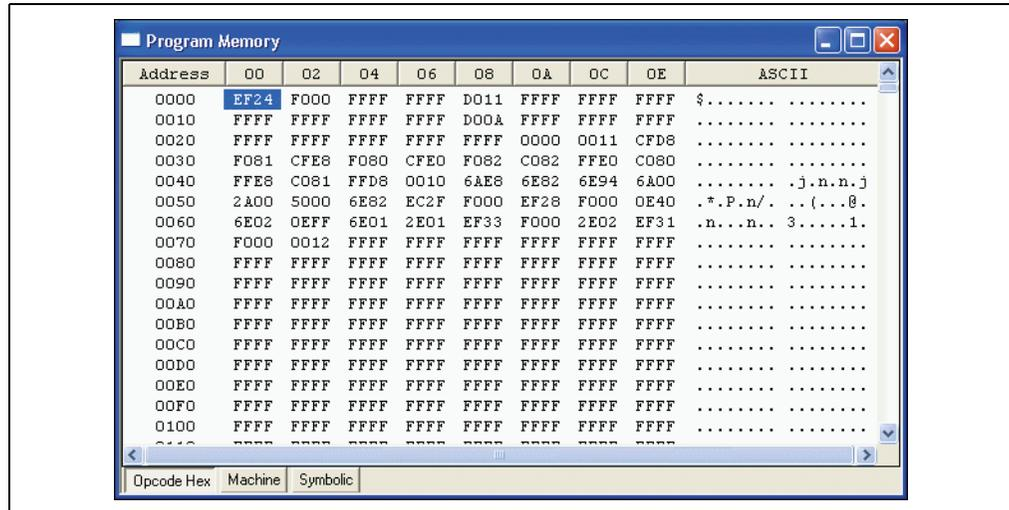

3.13 PROGRAMMING THE DEVICE

Now that you have your data in program memory, you can program the device. Make sure your PIC18F452 device is inserted in the appropriate socket on MPLAB PM3. Then, select *Programmer>Program*. The MPLAB IDE window will indicate the progress and, when finished, the Output window will display the results (see Figure 3-17).

FIGURE 3-17: PROGRAMMING RESULTS

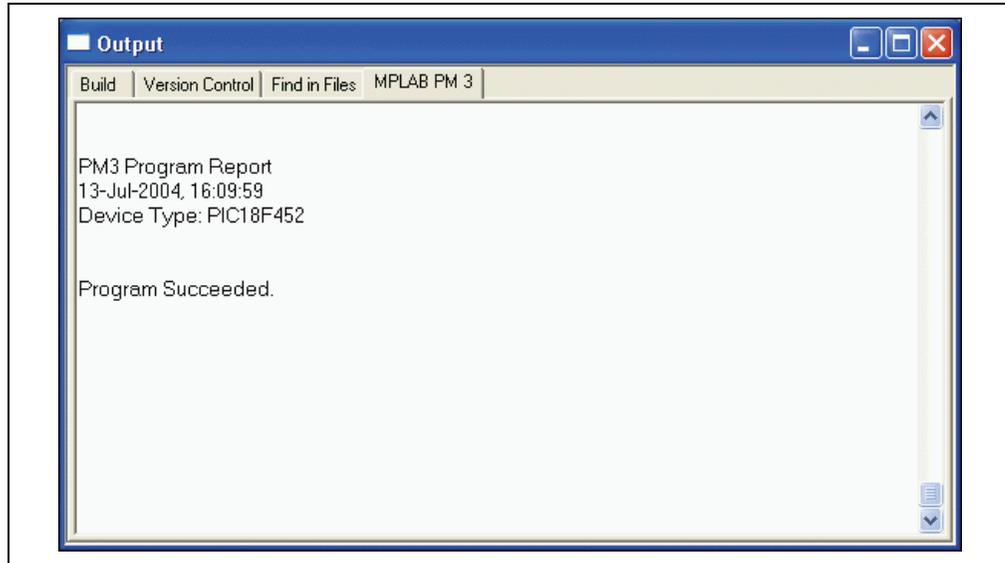

3.14 VERIFYING THE PROGRAMMING

Select *Programmer>Verify* to double-check the programming in the device. If any address locations on the device do not match program memory, an error log will display the discrepancies. If the bad data in the error log is 0000, try reseating the socket module.

3.15 TUTORIAL SUMMARY

By completing this tutorial, you have performed the major steps for creating, building and programming a simple project. Tasks completed include:

Selecting the device – the PIC18F452.

Using the Project Wizard to create a project, and using the wizard to:

- select MPLAB IDE built in MPASM assembler and MPLINK linker language tools,
- add files for the project: a template file for the device selected, and a linker script to build it properly.

Writing some simple code to send a changing value out an I/O port.

Building the project.

And finally, programming the PIC18F452 device.

These are the essential steps for programming a device with MPLAB IDE and MPLAB PM3.

Chapter 4. Using MPLAB PM3 with MPLAB IDE

4.1 INTRODUCTION

This chapter describes the main steps in programming and reading a device using the MPLAB PM3 device programmer. Topics covered in this chapter include:

- Before You Begin
- MPLAB PM3 Dialogs
- Setup for Programming a Device
- Programming a Device
- Verifying the Programming
- Reading a Device
- Special Programming

4.2 BEFORE YOU BEGIN

Before using MPLAB PM3, you must have performed the following initialization steps:

1. Installed the MPLAB IDE software (**Section 2.2 “Installing MPLAB PM3 Software”**) and MPLAB PM3 hardware (**Section 2.3 “Installing MPLAB PM3 Hardware”**).
2. Turned the power on MPLAB PM3 (**Section 2.4 “Powering Up MPLAB PM3”**).
3. Selected MPLAB PM3 as your programmer (**Section 2.5.2 “Selecting MPLAB PM3 as the Programmer”**).
4. Configured the communications port that MPLAB IDE will use to communicate with MPLAB PM3 (**Section 2.5.3 “Setting Up the Communications Port”**).
5. Selected the device you wish to program from the list of available devices (**Section 2.5.4 “Selecting a Device in MPLAB IDE”**).
6. Enabled (started) the MPLAB PM3 programmer (**Section 2.5.5 “Enabling MPLAB PM3”**).

4.3 MPLAB PM3 DIALOGS

The MPLAB PM3 Programmer Menu options are displayed when the programmer is enabled. If the option is unavailable, the item appears in gray (not black) text.

The next section will discuss how these dialogs are used to program devices.

4.4 SETUP FOR PROGRAMMING A DEVICE

To program a device, you will need:

- A hex file to program into the device.
- A device to program. Must be blank if non-flash device. (See **Section 7.4.7 “Blank Check All”**.)

4.5 PROGRAMMING A DEVICE

The steps to program a device include:

- Setting up the Configuration bits in the Configuration Bits dialog
- If needed, editing the ID in the User ID Memory dialog
- Loading the hex code into program memory or building the project into program memory
- Checking for a blank device (non-flash devices)
- Programming the device
- Verifying the programming
- Reading a device

4.5.1 Configuration Bits Dialog

The Configuration Bits dialog opens when you select *Configure>Configuration Bits*. The type and number of Configuration bits you see in this dialog will depend on the device you have selected.

You can also specify the Configuration bit values in your source code. Use the `__CONFIG` directive in MPASM assembler to set the Configuration bits for the device to be programmed. Each time you rebuild your project or reload your hex file, the Configuration bits will be set according to the values from this directive.

If you do not set Configuration bits in your source code, then these bits will not be changed. You can manually change them from their default values using the Configuration Bits dialog and they will be programmed into the device when you program the microcontroller.

A value set in the Configuration Bits dialog overrides any value set in the program.

Note: Setting Configuration bits here will not affect emulator or simulator operation.

To change the Configuration bits settings:

1. Make sure the Configuration Bits window is opened wide enough to view the Settings column (Figure 4-1).

FIGURE 4-1: CONFIGURATION BITS DIALOG

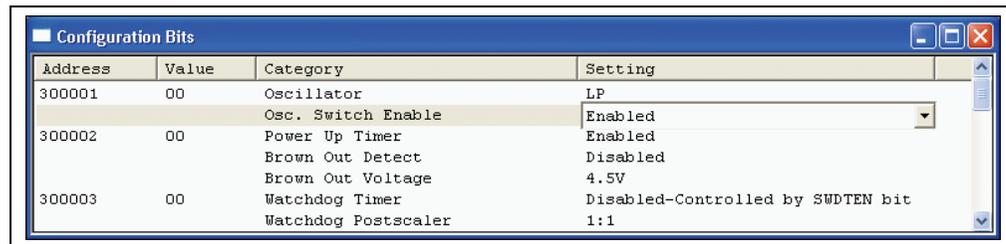

2. Click on the setting value you wish to change. A down arrow appears to the right of the value. Select a value from the drop-down list box.

4.5.2 User ID Memory Dialog

Select *Configure>ID Memory* to edit the user ID memory address.

You can also use the `__IDLOCS` directive to set the ID bytes from MPASM assembler. Each time you rebuild your project or reload your hex file, the ID locations will be set according to the values from the `__IDLOCS` directive.

An ID value set in the User ID Memory dialog (Figure 4-2) overrides any value set in the program.

FIGURE 4-2: USER ID MEMORY DIALOG

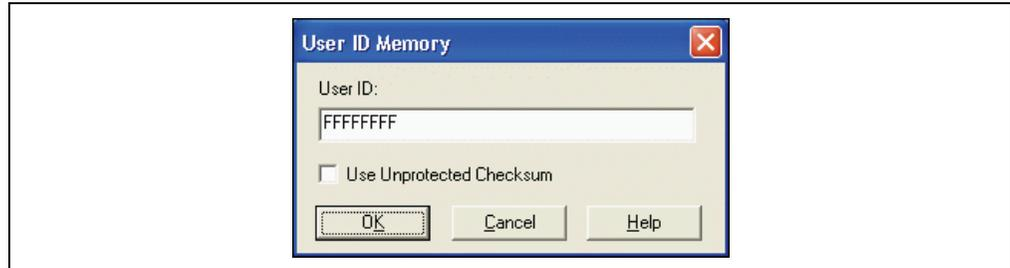

To change the User ID:

1. Type the User ID in the field.
2. Select or clear the “Use Unprotected Checksum” check box as needed.

It is recommended that if the device is code-protected, this box be checked to use an unprotected checksum. Most devices use this information to calculate the code-protected checksum.

3. Click **OK** to set the option or click **Cancel** to cancel the entry.

4.5.3 Loading the Hex Code into Program Memory

If you have a hex file (e.g., `code.hex`) ready for programming into a microcontroller, open the Program Memory window if it is not already open. To do so, from the MPLAB IDE menu, select **View>Program Memory**. Then, select **File>Import...** to browse for the file you want to load into the MPLAB IDE Program Memory window.

Note: There is no warning for importing files with invalid hex values. That is, the hex file of a 14-bit device may be loaded into the program memory of a 12-bit device and the hex file of a 16-bit device may be loaded into the program memory of a 14-bit device.

The Program Memory window should now contain the hex code from the hex file (Figure 4-3).

FIGURE 4-3: PROGRAM MEMORY — HEX CODE DISPLAY

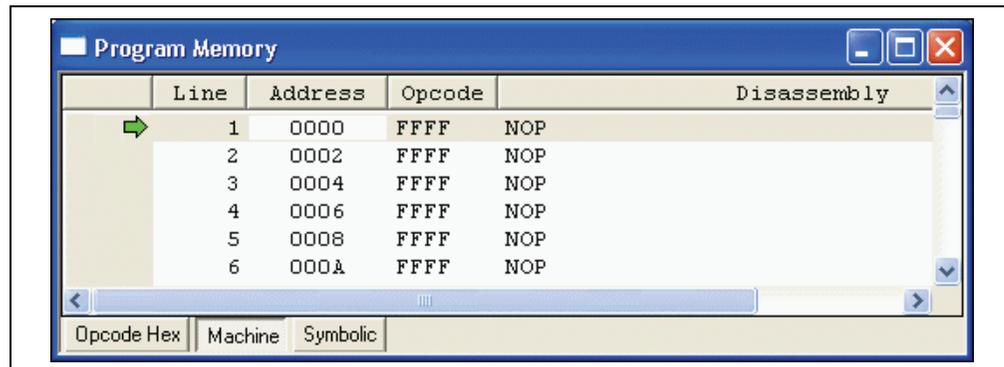

If you do not have a hex file with which to program your device, you can build one using MPLAB IDE Projects. MPLAB IDE provides a text editor for generation of source code and compatibility with various assemblers/compiler for assembling/compiling your source code into hex code in MPLAB IDE program memory. For an example on using MPLAB IDE Projects to create a hex file for device programming, refer to **Chapter 3. "Tutorial"**. Please read the MPLAB IDE documentation to see how to use MPLAB IDE Projects to develop your own firmware.

Each time you rebuild your project, the Program Memory window will be updated.

4.5.3.1 IMPORTED HEX FILES AND EEPROM DATA

If you imported your hex file into MPLAB IDE and are using EEPROM data memory, make sure your hex code specifies the start of EEPROM data memory. This needs to be specified for use with programmers.

4.5.4 Checking For a Blank Device (Non-Flash Devices)

You can perform a Blank Check by selecting *Programmer>Blank Check All* from the MPLAB PM3 menu. This check will verify that the device is completely blank (all bits are set to a '1') and all Configuration bits are set to a '1' (unprogrammed state).

If you are using a One-Time Programmable (OTP) device, some Configuration bits (e.g., oscillator bits) might have already been programmed at the factory. Make sure the Configuration bits are set to the factory settings and select *Programmer>Blank Check OTP*. This will check that all program memory bits are set to '1', and that the Configuration bits match the value in the dialog. An OTP device cannot be erased and reprogrammed.

If the EPROM device is not blank, you will have to erase it before programming, or select another device:

1. Remove any labels covering the device window. If you do not have a windowed device (Figure 4-4) you cannot reprogram it. A windowed version of all EPROM devices may be ordered by requesting the JW package.

FIGURE 4-4: WINDOWED DEVICE

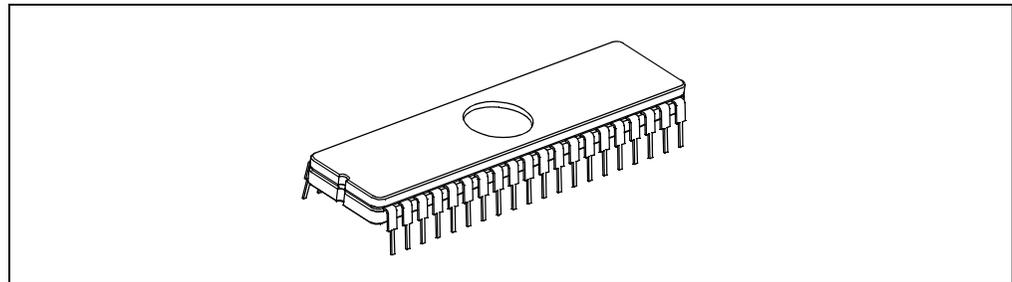

2. Place the device in an Ultraviolet (UV) EPROM Eraser. The amount of time required to completely erase a UV erasable device depends on: the wavelength of the light, its intensity, distance from UV source and the process technology of the device (the size of the memory cells).
3. Verify that the device is blank (i.e., perform the Blank Check again) before attempting to program it.

If the device is EEPROM/Flash, you do not have to erase it before reprogramming it. These devices are electrically erased before programming.

4.5.5 Programming the Device

You are ready to program your device. Select *Programmer>Program* to program the entire device (i.e., all of the program memory, Configuration bits, etc.).

If you want to program selectively (e.g., part of program memory, only Configuration bits), select *Programmer>Settings* to open the Programmer Settings dialog. Click the **Memory Ranges** tab (see Table 4-1 and **Section 7.5.1 “Memory Ranges Tab”**) and select the options for programming. Areas that are grayed out are not available on the device. Click **OK**. Then, select *Programmer>Program* to program the device. The memory area corresponding to the checked boxes will be programmed.

TABLE 4-1: MEMORY RANGES TAB OPTIONS

Option	Description
Program Memory Start Address	Type the start address for the range of program memory.
Program Memory End Address	Type the end address for the range of program memory.
Reset Addresses	Click this button to reset the program memory addresses.
Program Memory	Select this check box if you want to program Program Memory. The program memory range is determined by the program memory start and end address fields.
Configuration Bits	Select this check box if configuration memory is to be programmed.
ID Location	Select this check box if the ID location is to be programmed.
EEPROM Data	Select this check box if the EEPROM data memory is to be programmed.
Calibration Memory	Select this check box if calibration memory to be programmed.
Erase All Before Program	Select this check box if the device is to be erased before programming.

After MPLAB PM3 programs a device, it automatically performs a verify operation and displays any errors found. An additional verify operation may be done via selecting *Programmer>Verify*.

4.6 VERIFYING THE PROGRAMMING

Click *Programmer>Verify* to verify that the programming on the device matches the program memory, Configuration bits, ID locations, EEPROM and calibration memory values in MPLAB IDE and in the Settings dialog and Configuration Bits dialog.

If there are more errors than expected and those errors claim that the bad data is all zeros (0000), the socket module might not be seated properly. Remove and reseat the socket module. It is always a good practice to insert a known blank device and do a Blank Check whenever the socket module is changed.

Note: A verify is automatically done after a program command.

4.7 READING A DEVICE

To copy the firmware from a programmed device into an unprogrammed device, read the programmed firmware (program memory, Configuration bits, etc.) into MPLAB IDE, then program the new device based on this information.

To read the entire device (i.e., all of program memory, Configuration bits, etc.), click Programmer>Read.

To read selectively (e.g., part of program memory, only Configuration bits), select Programmer>Settings>Memory Ranges to display the Memory Ranges dialog. Select the options to be read, then click **OK** in this dialog. Areas that are grayed out are not available on the device. Then, select Programmer>Read. The memory area corresponding to the checked boxes will be read.

Once the Read is complete, the Program Memory window will display the data read from the device master. You can save that data as a hex file (File>Export), insert a new device into MPLAB PM3 to copy that same data into a new device, or modify the data in MPLAB IDE before you save to a hex file or program another device.

If you attempt to read a code-protected device, you will get a warning indicating that the device is code-protected and that the program memory may be invalid. If this happens, obtain the original hex code from a file or a non-protected device.

If you have an MPLAB ICE emulator connected to MPLAB IDE, your code will be downloaded to the emulated program memory of MPLAB ICE. If you have a project open, you will be asked if you want to close it before reading memory from a device.

Note: If you keep your project open, the Absolute Listing window and the Source Code window may not match the data you have read into the Program Memory window. Symbols may not match the proper addresses in the Program Memory window.

After reading a device into MPLAB IDE, its data will appear in the Program Memory window. You can modify the data, then save it to a hex file by selecting Project>Build Options>Project. See the MPLAB IDE documentation for more information.

4.8 SPECIAL PROGRAMMING

4.8.1 SQTP

Serial Quick Turn Programming (SQTP) allows you to program a unique serial number into each device. This number can be used as an entry code, password or ID number.

Serialization is done by using a series of RETLW (Return Literal W) instructions, with the serial number bytes as the literal data. To serialize, you must first generate a serialization file, and then use that file to serialize locations in the device microcontroller:

1. To generate an SQTP file, select Programmer>Settings>, click on the **SQTP** tab and fill in the dialog.
2. To activate serialization, select Programmer>Load SQTP File and choose the file.
3. To program the device, select Programmer>Program.

Refer to **Section 7.5.3 “SQTP Tab”** and **Section 7.6.1 “Using SQTP”** for more detailed information on SQTP programming. See **Section 7.7.1 “Using Hexadecimal Record Formats”** for information on hex record formats.

4.8.2 ICSP Programming

The ICSP (In-Circuit Serial Programming) socket is an extension of the MPLAB PM3 device programmer that allows you to program PICmicro microcontroller devices that are already installed in the target board.

MPLAB PM3 comes equipped with an ICSP header and cable. You can locate this connector under where a socket module would be installed. See **Section A.4 “ICSP Hardware Specifications”** for header and cable pinout information.

To program a device using ICSP:

1. Select *Programmer>Settings* and click the **Voltages** tab.
2. In the “ICSP Options” area, select “Low Voltage Program” to program using this method. Be sure to connect the LVP/PGM pin and Enable the Low Voltage Program Configuration bit if the Low Voltage Program option has been selected. Select “Power target circuit from MPLAB PM3” if you want to power the circuit through MPLAB PM3 instead of using power from the target board (Figure 4-5).

FIGURE 4-5: ICSP™ OPTIONS

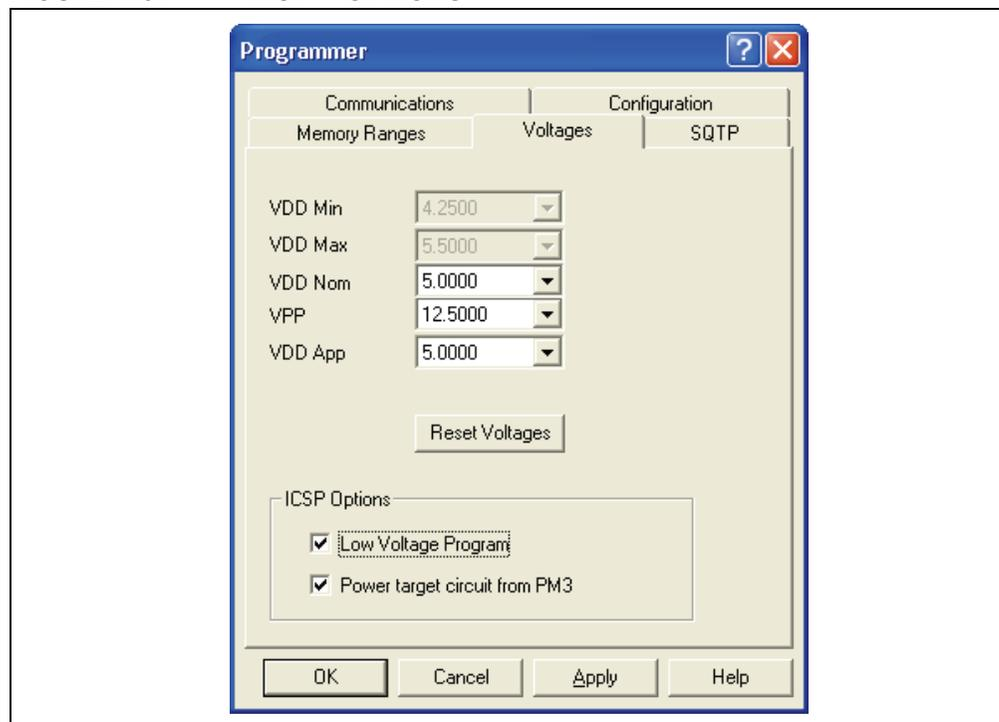

3. Connect the ICSP cable connector to the ICSP socket on MPLAB PM3.
4. Connect the necessary cables to the header on your target board. Refer to Table A-3 in **Appendix A. “Hardware Specifications”** for cable pins, colors and signals.
5. Program the device. See **Section 4.5 “Programming a Device”**.

Note: For information on how to program a specific device using ICSP, consult the programming specification for that device. See the README for MPLAB PM3 for a list of programming specifications of supported devices. Programming specifications may also be found on the Microchip web site at www.microchip.com.

Chapter 5. Using MPLAB PM3 in Stand-Alone Mode

5.1 INTRODUCTION

This chapter briefly describes how to use the MPLAB PM3 device programmer in Stand-Alone mode. The device programmer provides a graphical LCD interface that gives complete control over a programming session. Topics covered in this chapter include:

- Getting Started in Stand-alone Mode
- Programming a Device

See **Chapter 8. “Stand-Alone Reference”** for detailed descriptions on how to use MPLAB PM3 in Stand-Alone mode.

5.2 GETTING STARTED IN STAND-ALONE MODE

MPLAB PM3 operating in Stand-Alone mode allows you to read, program and verify a device without using a PC. Stand-Alone mode is useful in situations where a PC may not be available or even required, such as in the field or in a lab production environment.

5.2.1 Installing a Socket Module

See **Section 2.3.3 “Installing a Socket Module or ICSP Cable”** for instructions.

Note: An 18-inch ICSP cable is included with MPLAB PM3, eliminating the need for an ICSP socket.

Be sure to install the appropriate socket for the device being programmed. When the MPLAB PM3 device programmer is powered up, the unit automatically detects the type of socket module installed. If the part does not support the installed socket, MPLAB PM3 will list the appropriate sockets to use.

Note 1: MPLAB PM3 allows hot swapping of socket modules. If the status LED is not lit, feel free to switch sockets.

2: In order to use PRO MATE II socket modules with MPLAB PM3, you must obtain an AC164350 adapter kit. See the “*Development System Ordering Guide*” (DS30177).

5.2.2 Downloading a Hex File into MPLAB PM3 Memory

To set up MPLAB PM3 for Stand-Alone mode, you will need either a PC to download the hex file or a master device to read into MPLAB PM3 memory. Refer to **Chapter 2. “Installing MPLAB PM3”** and **Section 4.5.3 “Loading the Hex Code into Program Memory”** for instructions on connecting MPLAB PM3 to a PC and downloading a hex file, respectively.

Now you are ready to use MPLAB PM3 in Stand-Alone mode.

5.3 PROGRAMMING A DEVICE

After applying power to MPLAB PM3, the unit briefly displays the MPLAB PM3 splash screen and versions screen. Then, MPLAB PM3 displays the Main menu.

FIGURE 5-1: MPLAB® PM3 MAIN MENU

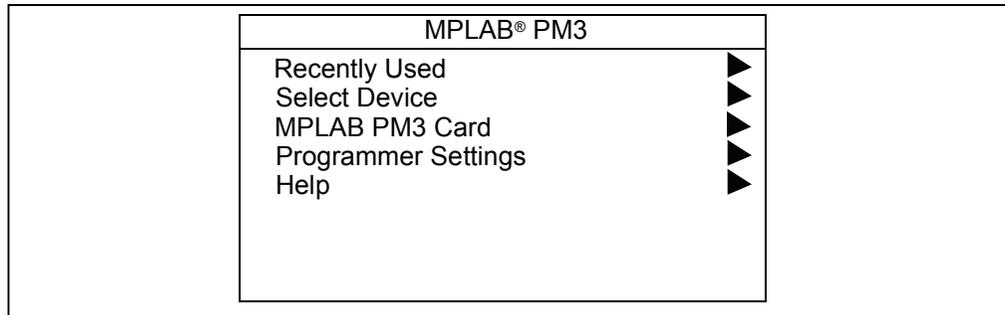

- Recently Used
- Select Device
- MPLAB PM3 Card (if inserted)
- Programmer Settings
- Help

5.3.1 Recently Used

Select “Recently Used” to retrieve the last device used in MPLAB PM3. This option displays the seven most recently used devices and enables quick access to the Command menu for the device.

5.3.2 Select Device

Select “Select Device” to indicate the device family and then, the device that is to be programmed. After the device is selected, MPLAB PM3 will display the Command Menu with commands that are applicable to the device type and its features, such as Program/Verify Device, Verify Device and All Functions.

5.3.2.1 PROGRAM/VERIFY DEVICE

Select “Program Verify Device” to program the device in the socket module with the hex file that was previously loaded into the internal memory of the device programmer. This is referred to as the image. If the hex file has not been loaded, the system displays a message stating “Valid image not present! Please download an image or use a master device before continuing”. Download the hex file desired for programming the device into MPLAB PM3 before attempting to continue.

The device programmer checks to see if the installed microcontroller device is blank. If the device is not blank, the device programmer asks if you want to continue. Answer “Yes” to continue. Answer “No” to return to the Command menu.

If a flash device is in use, the device will immediately be programmed with the image in the MPLAB PM3. If a One-Time Programmable (OTP) device is being used and the Blank Check Override is enabled on MPLAB PM3, two options (Stop Programming and Continue) will display if the device is not blank. Select “Stop Programming” if you do not wish programming to continue. Otherwise, select “Continue” and the device will be programmed.

MPLAB PM3 programs the image of the hex file into the microcontroller device connected to the programmer.

Using MPLAB PM3 in Stand-Alone Mode

Programming is performed at the V_{DD} Applied, the V_{DD} minimum and maximum voltages (OTP devices) or V_{DD} Nominal that has been established as the default per operating range for the device. See **Section 8.5.3.7.3 “Adjust Voltages”** if the verification needs to be performed at different voltage settings. Verification of the device against the MPLAB PM3 image occurs immediately after programming, along with the display of the resulting checksum if both have been successful.

If errors occur during programming or verification, the first address of each memory area that failed will be reported on the LCD.

5.3.2.2 VERIFY DEVICE

Select “Verify Device” to compare the contents of the device to that of the MPLAB PM3 memory (image). This comparison is performed at the V_{DD} Applied, V_{DD} minimum and maximum voltage (OPT devices) or V_{DD} Nominal that has been established as the default per the operating range for the device. See **Section 8.5.3.7.3 “Adjust Voltages”** if the verification needs to be performed at different voltage settings.

If the content of the device matches the MPLAB PM3 image, the message “Passed!” and the resulting checksum are displayed on the LCD. If not, the first address of each memory area that failed will be reported on the LCD.

5.3.2.3 READ DEVICE

Select “All Functions” then “Read Device” to retrieve the contents of the device and place it into the MPLAB PM3 memory. This image can then be used to program successive devices with the same information or the information can be code-protected then used for programming.

If the device is code-protected, a message stating that the device is code-protected will be displayed on the LCD and the contents will not be placed into the MPLAB PM3 memory. However, the resulting checksum will be included in the display if this option has been enabled in the Programmer Settings.

If the device is not code-protected, the contents will be placed into the MPLAB PM3 memory. Two options (No and Code Protect All?) will be displayed on the LCD along with the resulting checksum. Select “No” if code protection of the current or successive devices is not desired. Otherwise, select “Code Protect All?” if code protection of the current or successive devices is desired.

After selecting either code protection option, the display returns to the “Read Device” option. Press the <ESC> key to return to the Command menu for the device. If code protection was selected, “Program Verify Device” must be used to program the current or successive devices with the code-protected image in the MPLAB PM3 memory.

5.3.2.4 ALL FUNCTIONS

Select “All Functions” to display all of the stand-alone commands that are applicable to programming, reading, verifying and displaying the status of the currently selected device. See **Section 8.5.3 “All Functions”** for details on each of the options that may be available for the device.

5.3.3 MPLAB PM3 Card

If a memory card is inserted into MPLAB PM3, the Main menu included the MPLAB PM3 Card option. Selecting this option displays these additional options. Refer to **Section 9.4 “MPLAB PM3 Card in Stand-alone Mode”** for details on these options:

- Load an Environment
- View an Environment
- View Disk Contents
- Open a test File (*.txt)
- Card Properties

5.3.4 Programmer Settings

From the Programmer Settings option on the Main menu, you can access these options. Refer to **Section 8.4.3 “Programmer Settings”** for more details.

- Screen Contrast
- Buzzer Volume
- Socket Information
- Checksum Calculation
- Device ID Option (Beta)
- Blank Check Override
- Go Pin Functionality

5.3.5 Help

The Help option displays the version number of the MPLAB PM3 OS Suite running on MPLAB PM3 and these submenu options. Refer to **Section 8.4.4 “Help”** for details.

- ICSP Connector Pinout
- Status Bar Icons
- About

Chapter 6. Using the MPLAB PM3 Card

6.1 INTRODUCTION

This chapter describes the MPLAB PM3 Card functions and introduces the concept of an Environment.

The MPLAB PM3 Card is a multimedia, stamp-sized, Flash memory card that weighs approximately 2 grams. It provides:

- portable means to store and transfer information
- fast copy/download
- high storage capacity
- nonvolatile solid-state; data is not lost when power is turned off
- write-protect switch on the card casing (for SD cards only)

Using the MPLAB PM3 Card allows you to store information onto the MMC card, send it to a manufacturer, have them place it in their MPLAB PM3 and program Microchip microcontrollers without ever touching a PC.

Topics covered in this chapter include:

- MPLAB PM3 Environment
- MPLAB PM3 Card

6.2 MPLAB PM3 ENVIRONMENT

The MPLAB PM3 device programmer uses a new concept called an MPLAB PM3 Environment. An Environment is a snapshot of the current programming settings for a specific device. It contains all the necessary information to recreate the current programming state, including a binary image of the device's memory data, links to an optional SQTP file, specific part information and optional miscellaneous files.

When an Environment is saved, a directory is created on the removable MPLAB PM3 Card (an SD-MMC memory card), on the selected drive on a PC or another storage device. The name of the directory created is the same as the name given to the Environment file. Figure 6-1 illustrates the layout of an Environment.

As an introduction to environments, this covers:

- Creating an MPLAB PM3 Environment on the MPLAB PM3 Card
- Loading an MPLAB PM3 Environment into the MPLAB PM3 programmer

There are additional operations, such as viewing, copying and deleting Environments. Refer to **Chapter 9. "MPLAB PM3 Card Reference"** for specific instructions for each of these operations.

FIGURE 6-1: LAYOUT OF AN ENVIRONMENT

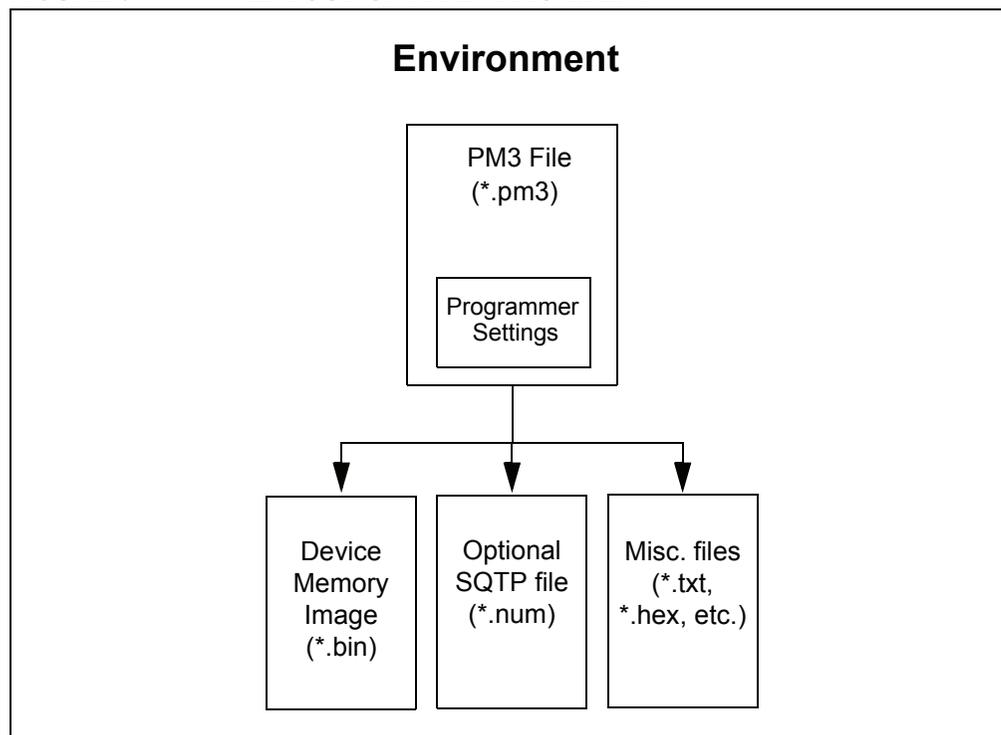

An Environment is the encapsulation of the environment file (*.pm3), the binary bin file (*.bin), optional SQTP num file (*.num) and miscellaneous files.

The PM3 file (*.pm3) is a part of the Environment. It is the high-level file that contains MPLAB PM3's settings, name of the bin file and name of the SQTP file.

The device's image (binary file) is the data that should be programmed into the device. It is the same continuous data chunk that is sent between MPLAB IDE and MPLAB PM3 during a standard operation. Error detection mechanisms are also attached.

6.2.1 Creating an MPLAB PM3 Environment on the MPLAB PM3 Card

An Environment can be created in MPLAB IDE and saved to the MPLAB PM3 Card, your hard drive or other storage device. Multiple Environments can be created, each with its unique name and settings. When an Environment is created and saved, the environment file and all associated files are saved into the same folder.

To create and save an MPLAB PM3 Environment on the MPLAB PM3 Card using MPLAB IDE:

1. Open a workspace or import a hex file into MPLAB IDE. Refer to the MPLAB IDE on-line help for additional information.
2. If the MPLAB PM3 programmer is not already enabled, select *Programmer>Enable Programmer* to enable the programmer.
3. Select *Configure>Select Device* to open the Select Device dialog. Select the device for which you wish to create an Environment. (See **Section 2.5.4 “Selecting a Device in MPLAB IDE”** for additional information.)
4. Select *Programmer>Settings* to configure the MPLAB PM3 programmer’s settings, such as the memory ranges, voltages or SQTP. (See **Section 7.5 “Programmer Settings”** for additional information.) When finished, click **OK** to close the Programmer dialog.
5. Select *Programmer>Environment>Save* to open the Save Environment dialog (Figure 6-2).

FIGURE 6-2: SAVE ENVIRONMENT DIALOG



6. Enter a name for your environment into the "Environment Name" field. The Environment name can be a maximum of 127 characters.
7. (Optional) Click **Browse** in the "Misc. Files" field and select a maximum of 10 files (.txt, .hex, etc.) you want to associate with the Environment.
8. (Optional) Enter a brief description into the "Description" field.
9. Click **Browse** in the "Destination" field and select "MPLAB PM3 CARD" as the destination.

Note: The destination can also be your hard drive or another storage device.

10. Click **OK** to close the Environment Destination dialog.
11. Click **Save** to save the environment to the MPLAB PM3 Card. Once successfully created, the Output window will display "Environment Name has been created".
12. Click **Close** to close the Save Environment dialog.

6.2.2 Loading an MPLAB PM3 Environment into the MPLAB PM3 Programmer

You can load an Environment from the MPLAB PM3 Card into the MPLAB PM3 programmer using either the MPLAB IDE software or Stand-Alone mode.

6.2.2.1 USING MPLAB IDE TO LOAD AN ENVIRONMENT

1. Ensure the MPLAB PM3 Card is fully inserted into the SD-MMC card slot on the back of the MPLAB PM3 programmer, the programmer is powered on and the programmer is enabled through the MPLAB IDE Programmer menu.
2. From the MPLAB IDE Main menu, select *Programmer>Environment>Load* to open the Load Environment window.
3. Expand the MPLAB PM3 Card directory to display the *.pm3 file you want to load into the programmer.
4. Select the *.pm3 file you wish to load and click **OK**.
5. When complete, the Load Environment window closes and a completion message displays in the Output window.

6.2.2.2 USING STAND-ALONE MODE TO LOAD AN ENVIRONMENT

1. Ensure the MPLAB PM3 Card is fully inserted into the SD-MMC card slot on the back of the MPLAB PM3 programmer and the programmer is powered on.
2. From the MPLAB PM3 Main menu, select MPLAB PM3 card and press <ENTER>.
3. From the MPLAB PM3 card menu, select Load an Environment and press <ENTER>.
4. From the PM3CARD:*.pm3 menu, select your Environment folder and press <ENTER>.
5. Select your Environment.pm3 from the your Environment folder and press <ENTER>.

6.3 MPLAB PM3 CARD

The MPLAB PM3 Card is an MMC card formatted, FAT16-based file system for cross-readability through an external reader. MPLAB IDE is able to communicate to the MPLAB PM3 Card through both serial and USB interfaces. The MPLAB PM3 Card can also be accessed through the MPLAB IDE software or through the MPLAB PM3 programmer in Stand-Alone mode.

6.3.1 MPLAB PM3 Card Through MPLAB IDE

Through the MPLAB IDE Programmer menu, you can perform these operations on the MPLAB PM3 Card:

- List files – displays a list of files on the MPLAB PM3 Card
- Format – formats MMC cards in FAT16 format. This operation erases any data that may be stored on the MPLAB PM3 Card and formats the card to the standard FAT16 format.
- Properties – displays the properties of the MPLAB PM3 Card including card capacity, bytes free, bytes used and cluster size.

For detailed instructions, see **Section 9.3 “MPLAB PM3 Card Through MPLAB IDE”**.

6.3.2 MPLAB PM3 Card Through MPLAB PM3 Programmer

In Stand-Alone mode, you can perform these operations on the MPLAB PM3 Card:

- View Disk Contents – displays the contents of the MPLAB PM3 Card on the MPLAB PM3 LCD screen
- Open a text File (*.txt) – displays the first 10 lines (approximately) of text from the selected text file on the programmer’s LCD screen
- Load an Environment – loads the selected Environment stored on the MPLAB PM3 Card into the MPLAB PM3 programmer
- View an Environment – displays information including the device, memory files and description of an Environment stored on the MPLAB PM3 Card
- Card Properties – displays the properties of the MPLAB PM3 Card including card capacity, bytes free, bytes used and cluster size

For detailed instructions, see **Section 9.4 “MPLAB PM3 Card in Stand-alone Mode”**.

MPLAB[®] PM3 User's Guide

NOTES:

Chapter 7. MPLAB PM3 – MPLAB IDE Reference

7.1 INTRODUCTION

This chapter describes the dialogs, windows, menus and options of the MPLAB PM3 development system. Topics covered in this chapter include:

- MPLAB PM3 Toolbar
- Configure Menu
- MPLAB PM3 Programmer Menu
- Programmer Settings
- Special Programming
- Files Used by MPLAB PM3
- Upgrading the MPLAB PM3 Operating System

7.2 MPLAB PM3 TOOLBAR

The MPLAB PM3 toolbar (Figure 7-1) consists of icons for some of the programmer functions and a program statistics display.

FIGURE 7-1: MPLAB® PM3 TOOLBAR

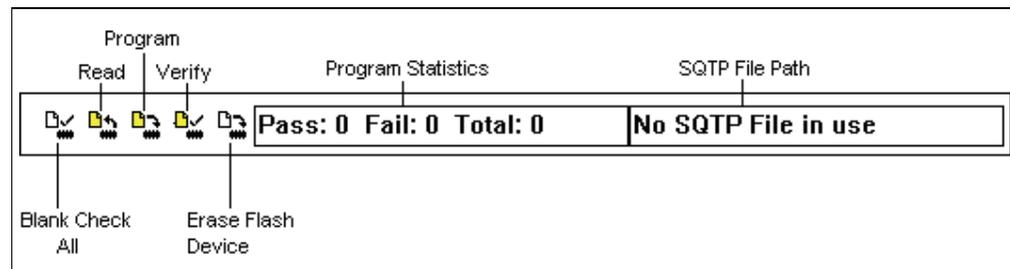

Position the mouse pointer over the toolbar item to display the name. Table 7-1 lists the items on the toolbar.

TABLE 7-1: MPLAB® PM3 TOOLBAR COMMANDS

Symbol	Command	Description
	Blank Check All	Checks that the device is completely blank (all bits are set to '1'). This will also check that all Configuration bits are set to '1' (unprogrammed state). (Same as <i>Programmer>Blank Check All.</i>)
	Read	Reads the device. (Same as <i>Programmer>Read.</i>)
	Program	Programs the device. (Same as <i>Programmer>Program.</i>)
	Verify	Verifies that the device was programmed properly. (Same as <i>Programmer>Verify.</i>)
	Erase Flash Device	Erase all memory on a Flash Device. (Same as <i>Programmer>Erase Flash Device.</i>)
	Program Statistics	Provides the number of programming attempts: passed, failed and total. To clear the values in this display, select <i>Programmer>Reset Program Statistics.</i>
	SQTP File Path	Displays the Serial Quick Turn Programming (SQTP) file path.

7.3 CONFIGURE MENU

The Configure Menu is an MPLAB IDE menu used in conjunction with the MPLAB PM3 Programmer Menu. Refer to the MPLAB IDE documentation for detailed information. The Configure Menu consists of five dialog selections listed in Table 7-2.

TABLE 7-2: CONFIGURE MENU

Selection	Description
Select Device	Select the device.
Configuration Bits	Select values for the device Configuration bits. Setting these values will affect both debugger and programmer operation.
External Memory	Select whether to use external memory or not. Also specify external memory range.
ID Memory	Enter value into ID memory.
Settings	Enter default setting for the workspace, debugger, program loading, hot keys and project.

MPLAB PM3 – MPLAB IDE Reference

7.4 MPLAB PM3 PROGRAMMER MENU

Once the MPLAB PM3 programmer is selected, the full programmer menu displays (see Table 7-3). The programmer must be enabled to make additional options available. Some of the MPLAB PM3 options are accessible through the MPLAB PM3 Toolbar.

TABLE 7-3: MPLAB® PM3 MENU

Selection	Description
Select Programmer	Lists the available programmers.
Enable Programmer	Enables the programmer.
Disable Programmer	Disables the programmer.
Program	Transfers the hex data file to the programmer and programs the device. Selective programming (e.g., part of program memory, or only Configuration bits) can be configured with the “Programmer Settings” option below.
Verify	Verifies that the device was programmed properly.
Read	Reads the device content. Selective read (e.g., part of program memory, only Configuration bits of the device) can be done by setting up “Settings” below.
Blank Check All	Checks that the device is completely blank (all bits are set to ‘1’). This will also check that all Configuration bits are set to the default value.
Blank Check OTP	This function is intended for use with OTP devices that come with factory programmed Configuration bits. Before using this function, set the displayed Configuration bits to match the factory programmed settings. The function verifies that all program memory bits are set to ‘1’ and that the Configuration bits match the settings displayed in the Configuration Bits dialog.
Erase Flash Device	Erase all memory on a Flash device.
Reset Program Statistics	Resets the counters in the Program Statistics area.
Transfer to MPLAB PM3	Transfers the image of the MPLAB IDE’s memory to the programmer, but does not program the device. This is useful for stand-alone operation.
Transfer from MPLAB PM3	Transfers the image of the programmer’s memory to MPLAB IDE, but does not read the device memory. This is useful for reading back the memory after working in Stand-Alone mode.
Establish Communications	Resets the programmer hardware and reestablishes communications. Use this option if power has been disconnected from the programmer. This option does not reset programming information in the Program Memory window, Configuration bits or IDs.
Load SQTP File	Allows the user to select a previously defined SQTP file. Refer to Using SQTP.
About	Displays the OS Suite version of MPLAB PM3.
Environment	Displays a submenu of operations the can be performed on the environment. See Chapter 9. “MPLAB PM3 Card Reference” for more information on the environment operations.
MPLAB PM3 Card	Displays a submenu of operations that pertain to the MPLAB PM3 Card. See Chapter 9. “MPLAB PM3 Card Reference” for more information on the MPLAB PM3 Card operations.
Settings	Opens the Programmer dialog, which allows setting the memory ranges and voltage specs, SQTP and communication ports. Programmer options Program, Read, Verify, Transfer to MPLAB PM3 and Transfer from MPLAB PM3 will be limited to these settings until reset.

7.4.1 Select Programmer

To select the MPLAB PM3 programmer, select *Select Programmer>MPLAB PM3*. Once the programmer is selected, the Output window opens.

7.4.2 Enable Programmer

To enable the MPLAB PM3 programmer, select *Programmer>Enable Programmer*.

If updates are available for the programmer firmware, MPLAB IDE may display a prompt to update. If auto download has been set in the Configuration dialog, MPLAB IDE will automatically update the necessary files.

Once the MPLAB PM3 programmer is selected, the full menu displays. Enable the programmer to make additional menu items available. Some of the MPLAB PM3 menu items are similar to buttons on the MPLAB PM3 Toolbar.

7.4.2.1 OUTPUT WINDOW

When you select *Programmer>Select Programmer>MPLAB PM3* from the MPLAB PM3 menu or select *View>Output* from the MPLAB IDE menu, the Output window opens. This window contains tabbed information about program output. Refer to the MPLAB IDE documentation for more information.

The menu items in the Output window available from the right mouse button menu are:

- Select All – Selects all text and graphics in the Edit window.
- Copy – Copies the selected text in the current window onto the clipboard. After this operation, paste the copied text into another MPLAB Editor window, into another location in the same MPLAB Editor window, or into another Windows application.
- Clear Page – Clears the contents of the Output window.

7.4.2.2 PROGRAM MEMORY WINDOW

When you select *View>Program Memory* from the MPLAB IDE menu, the Program Memory window (Figure 7-2) opens in machine code view.

FIGURE 7-2: PROGRAM MEMORY WINDOW

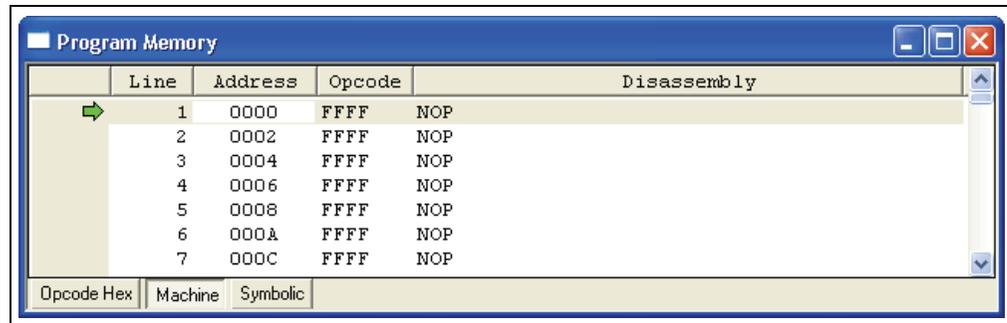

You can view the Program Memory as hex code, machine code or disassembled with symbols (if available). Change the display mode by clicking on the **Display Option** button in the lower left corner of the window.

When the MPLAB ICE emulator is selected as the Debugger, the Program Memory window shows the data that is in the emulation memory of the MPLAB ICE pod. This memory is read by the MPLAB ICE probe when run, single stepped or traced using the emulator.

When the simulator is selected as the Debugger, the Program Memory window reflects the contents of a memory buffer on the PC. This memory is read by MPLAB SIM when run, single stepped or traced.

If program memory is read with the MPLAB PM3 programmer while in emulator or simulator mode, it will overwrite the program memory being emulated or simulated. This can cause “mismatches” between the program memory and debug information if an MPLAB IDE project is open. The system displays an option to either close the current MPLAB IDE project or to continue and read the device’s memory into the Program Memory window. Subsequent debug operations might not work properly.

7.4.3 Disable Programmer

To disable the MPLAB PM3 programmer, select *Programmer>Disable Programmer*.

7.4.4 Program

Select *Programmer>Program* to program the entire device (i.e., all of the program memory, Configuration bits, etc.).

To program selectively (e.g., part of program memory, only Configuration bits), select *Programmer>Settings* to open the Programmer Settings dialog. Click the **Memory Ranges** tab and select the options for programming. Areas that are grayed out are not available on the device. Click **OK**. Then select *Programmer>Program* to program the device. The memory area corresponding to the checked boxes will be programmed.

After MPLAB PM3 programs a device, it automatically performs a verify operation and displays any errors found. An additional verify operation may be done via selecting *Programmer>Verify*.

7.4.5 Verify

To verify the programming on the device, select *Programmer>Verify*. This verifies that the programming on the device matches the program memory, Configuration bits, ID locations, EEPROM and calibration memory values in MPLAB IDE and in the Settings dialog and Configuration Bits dialog.

If there are more errors than expected and those errors claim that the bad data is all zeros (0000), the socket module might not be seated properly. Remove and reseal the socket module. It is always a good practice to insert a known blank device and do a Blank Check whenever the socket module is changed.

When the programming is finished, “Programming/Verification completed successfully!” will be displayed in the Output window. If the programming failed, an error message will appear showing the good (expected) data and the bad (actual) data for each address it attempted to program.

7.4.6 Read

To copy the firmware from a programmed PIC MCU device into an unprogrammed device, read the programmed firmware (program memory, Configuration bits, etc.) into MPLAB IDE, then program the new device based on this information.

To read the entire device (i.e., all of program memory, Configuration bits, etc.), click Programmer>Read.

To read selectively (e.g., part of program memory, only Configuration bits), select Programmer>Settings>Memory Ranges to display the Memory Ranges dialog. Select the options to be read, then click **OK** in this dialog. Areas that are grayed out are not available on the device. Then, select Programmer>Read. The memory area corresponding to the checked boxes will be read.

Once the Read is complete, the Program Memory window will display the data read from the device master. Save that data as a hex file and insert a new device into MPLAB PM3 to copy that same data into a new device, or modify the data in MPLAB IDE before saving to a hex file or program another device.

Attempting to read a code-protected device displays a warning indicating that the device is code-protected, and that the program memory may be invalid. If this happens, obtain the original hex code from a file or a non-protected device.

If an MPLAB ICE emulator is connected to MPLAB IDE, the code will be downloaded to the emulated program memory of the MPLAB ICE. If a project is open, the system asks if you want to close it before reading memory from a device.

Note: If the project is kept open, the Absolute Listing window and the Source Code window may not match the data previously read into the Program Memory window. Symbols may not match the proper addresses in the Program Memory window.

7.4.7 Blank Check All

After inserting the device in the socket, select Programmer>Blank Check All from the MPLAB PM3 menu. This check will verify that the device is completely blank (all bits are set to '1') and all Configuration bits are set to the default value.

When complete, the results will be displayed in the Output window, for example:

```
Configuration memory is blank.  
EEData memory is blank.  
ID memory is blank.  
Program memory is blank.
```

If using a One-Time Programmable (OTP) device, some Configuration bits (e.g., oscillator bits) might have already been programmed at the factory. Make sure the Configuration bits are set to the factory settings and select Programmer>Blank Check OTP. This will check that all program memory bits are set to '1', and that the Configuration bits match the value in the dialog. An OTP device cannot be erased and reprogrammed.

If the EPROM device is not blank, erase it before programming, or select another device:

1. Remove any labels covering the device window. A non-windowed device cannot be reprogrammed. A windowed version of all EPROM devices may be ordered by requesting the JW package.
2. Place the device in an Ultraviolet (UV) EPROM Eraser. The amount of time required to completely erase a UV erasable device depends on: the wavelength of the light, its intensity, distance from UV source and the process technology of the device (how small the memory cells are).
3. Before attempting to program the device, perform the Blank Check again to verify that it is blank.

Note: If the device is EEPROM or Flash, it is not necessary to erase it before reprogramming it. These devices are electrically erased before programming.

7.4.8 Erase Flash Device

With the device inserted the socket, select *Programmer>Erase Flash Device* from the MPLAB PM3 menu. Then, select *Programmer>Blank Check All* from the MPLAB PM3 menu. This check will verify that the device is completely blank (all bits are set to '1') and all Configuration bits are set to the default value.

7.4.9 Reset Program Statistics

To reset all the program statistics, select *Programmer>Reset Program Statistics*. This command will reset the counters in the Program Statistics area.

7.4.10 Transfer to MPLAB PM3

To transfer the hex file to the programmer, select *Programmer>Transfer to MPLAB PM3*. This command only transfers the data, it does not program the device. This is usually used for stand-alone operation.

7.4.11 Transfer from MPLAB PM3

To transfer the programmer memory to the hex file, select *Programmer>Transfer from MPLAB PM3*. This command only transfers the programmer memory, it does not read the device memory. This is especially useful for reading the programmer memory back after working in Stand-Alone mode.

7.4.12 Establish Communications

To establish communications between the PC and MPLAB PM3 after power has been disconnected from the programmer, select *Programmer>Establish Communications*. This command resets the programmer hardware and reestablishes communications. It does not reset programming information in the Program Memory window, Configuration bits or IDs.

7.4.13 About

Select *Programmer>About* to display version of the MPLAB PM3 OS Suite in the programmer.

7.5 PROGRAMMER SETTINGS

Select *Programmer>Settings* to display the Programmer Settings dialog.

- Memory Ranges Tab
- Voltages Tab
- SQTP Tab
- Communications Tab
- Configuration Tab

7.5.1 Memory Ranges Tab

Select *Programmer>Settings* and click on the **Memory Ranges** tab to select device memory areas for programming (see Figure 7-3 and Table 7-4).

FIGURE 7-3: MEMORY RANGES TAB

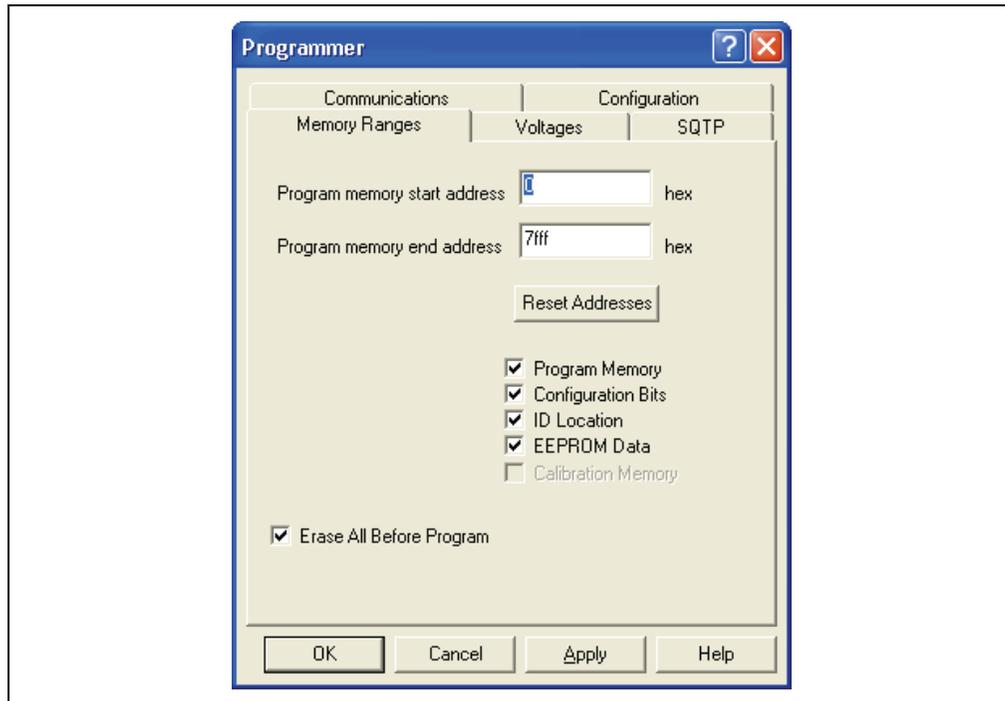

TABLE 7-4: MEMORY RANGES OPTIONS

Selection	Description
Program Memory Start Address	Type the start address for the range of program memory (in hex).
Program Memory End Address	Type the end address for the range of program memory (in hex).
Reset Addresses	Click this button to reset the program memory addresses.
Program Memory	Select this check box to program Program Memory. The program memory range is determined by the Program memory start and end address fields.
Configuration Bits	Select this check box if configuration memory is to be programmed.
ID Location	Select this check box if the ID location is to be programmed.
EEPROM Data	Select this check box if the EEPROM data memory is to be programmed.
Calibration Memory	Select this check box if calibration memory to be programmed.
Erase All Before Program	Select this check box if the device is to be erased before programming.

7.5.2 Voltages Tab

Select *Programmer>Settings* and click on the **Voltages** tab to view or set the voltages for the device (Figure 7-4).

FIGURE 7-4: VOLTAGES TAB

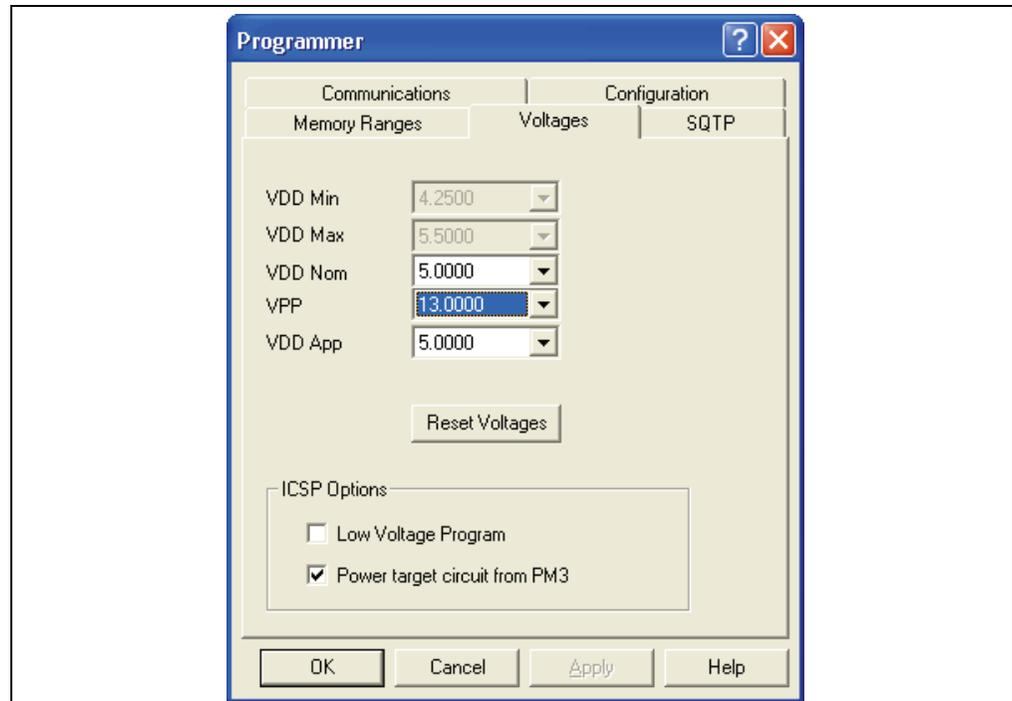

MPLAB® PM3 User's Guide

Certain voltages may be viewed/set for Flash devices (see Table 7-5) and Non-Flash devices (see Table 7-6). Other voltages are applicable to both types of devices (see Table 7-7). For Information on changing voltage settings and using low voltage programming, see **Section 7.5.2.1 “Changing Voltage Settings”** and **Section 7.5.2.2 “Using Low Voltage Program”**, respectively.

TABLE 7-5: FLASH DEVICES

Selection	Description
VDD APP	This is the voltage used by the programmer to verify Flash memory. The default is the device's nominal voltage value.

TABLE 7-6: NON-FLASH DEVICES

Selection	Description
VDD Min	This voltage and VDD Max are used by the programmer to verify memory in EEPROM devices. The value should be the minimum voltage for the designated circuit. The default is the device's minimum voltage value.
VDD Max	This voltage and VDD Min are used by the programmer to verify memory. The value should be the maximum voltage for the designated circuit. The default is the device's maximum voltage value.

TABLE 7-7: ALL DEVICES

Selection	Description
VDD Nom	This is the voltage at which the device is programmed. This should be the average voltage at which the system will run. The default is 5 volts.
VPP	This is the voltage used to bring the device into a programming mode. Although this is dependent of the device's programming specification, it may be changed. If “Low Voltage Program” is selected, this is changed to VDD Nom by the programmer.
Reset Voltages	Resets all voltages to their default values.
Low Voltage Program	In ICSP™ mode, select this checkbox to perform Low Voltage programming. Low Voltage programming uses a dedicated pin to enter into the programming mode versus a high voltage on VPP. This check box is ignored when a socket is installed.
Power Target Circuit from MPLAB PM3	In ICSP mode, this allows the target circuit to be powered from MPLAB PM3 to supply power for programming. This check box is ignored when a socket is installed.

7.5.2.1 CHANGING VOLTAGE SETTINGS

Change voltage settings only if the application runs at the extreme voltage operating range. Most users will never need to change the default voltage settings.

- Flash Devices: VDD APP is the voltage that a Flash device will be verified.
- Non-Flash Devices: VDD MAX and VDD MIN are the voltages at which programmed microcontroller devices will be verified.
- VDD NOM is the voltage at which the device will be programmed.
- VPP is the voltage at which the device will enter programming mode.

Select *Programmer>Settings* and click on the **Voltages** tab to display the current voltage settings. To change a voltage, select the desired VDD minimum, nominal, maximum or VPP voltage value from the list next to each setting.

Note: The voltage range and default voltage setting may be different for each microcontroller device type. Refer to the device programming specification for voltage values for each device.

TABLE 7-8: VOLTAGE SETTINGS

Voltage	Selection	Default Voltage
VDD APP	(2.00 .. 5.5)	5.00
VDD MIN	(2.00 .. 5.5)	3.00
VDD MAX	(2.00 .. 5.5)	5.50
VDD NOM	(2.00 .. 5.5)	5.00
VPP	(12.5 .. 13.5)	13.25

7.5.2.2 USING LOW VOLTAGE PROGRAM

The Low Voltage Program checkbox under Voltages functions as follows:

- Enabled only when a Flash device that is low voltage capable is selected.
- Selection is transferred from MPLAB IDE to MPLAB PM3 by performing a Blank Check, read, program, verify or transfer to MPLAB PM3. Transfer from the programmer will not update the checkbox in MPLAB IDE.
- Setting of the low voltage checkbox has no impact on the enabling/disabling of the low voltage Configuration bit.
- Only performs a Low Voltage Program in ICSP mode. See **Section 7.6.2.1 “Using Low Voltage Program”**.

7.5.3 SQTP Tab

Use Serial Quick Turn Programming (SQTP) to program a unique serial number into each device. This number can be used as an entry code, password or ID number.

Select *Programmer>Settings* and click on the **SQTP** tab to view or set up SQTP programming for the device (Figure 7-5). Also see **Section 7.6.1 “Using SQTP”**.

FIGURE 7-5: SQTP TAB

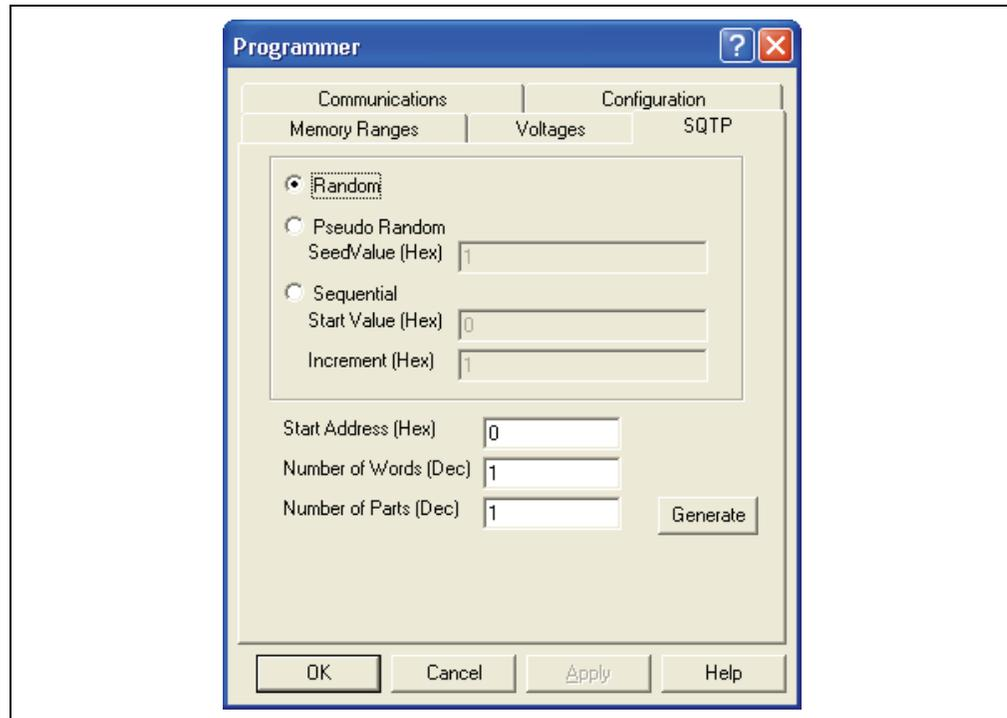

TABLE 7-9: SQTP MENU

Selection	Description
Random	Select this option to generate unique, random numbers for each part.
Pseudo-Random Seed Value (Hex)	Select this option to generate a pseudo-random set of non-repeating numbers based on the seed value specified.
Sequential Start Value (Hex) Increment (Hex)	Select this option to generate sequential numbers based on the starting value specified and incrementing each number by the amount specified.
Start Address (Hex)	Enter the starting address (in hex) for the serial number.
Number of Words (Dec)	Enter the size of the serial number. Make sure a large enough serial number is specified for the number of parts planned to program using this file.
Number of Parts (Dec)	Enter the number of parts to be programmed using this file.
Generate	Opens the Save SQTP File As dialog.

7.5.4 Communications Tab

To set the port for communications between the programmer and the PC, select *Programmer>Settings* and click on the **Communications** tab. Communications between the programmer and the PC may be either over a serial connection or a USB connection.

Note: Do not physically connect both.

The Windows COM port setup requires special attention. The proper drivers must be installed and the port may need to be set up manually. For additional information on the communication port setup, refer to **Section 2.3.1 “Installing the Communications Cable”**, **Section 2.5 “Configuring MPLAB IDE for Use with MPLAB PM3”** and **B.5.1 “Failure to Establish Communication with Programmer”**.

7.5.4.1 SERIAL COMMUNICATION

To use RS-232 (serial) communications between the PC and the MPLAB PM3 device programmer, select the PC COM port for use: COM1, COM2, COM3 or COM4 (Figure 7-6). COM1 is the default. Click **OK**.

FIGURE 7-6: SERIAL COM PORT

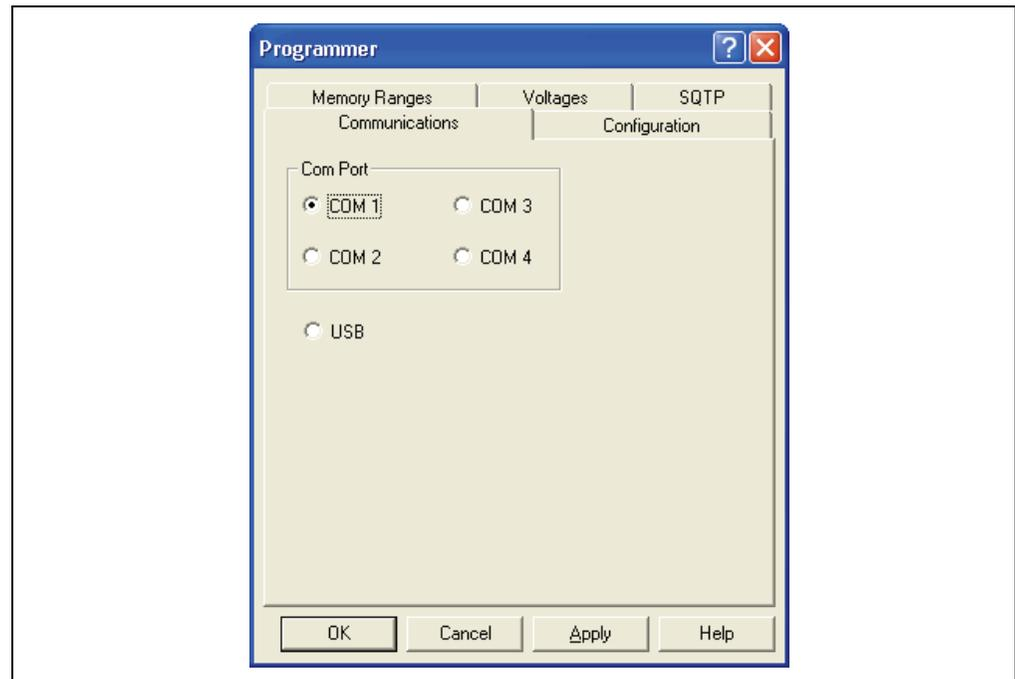

To make sure the port is set up properly, follow the instructions in the “**For RS-232 Communications**” subsection in **Section 2.3.1 “Installing the Communications Cable”**.

7.5.4.2 USB COMMUNICATIONS

To use USB communications between the PC and the MPLAB PM3 device programmer, select the USB port (Figure 7-7). Click **OK**.



FIGURE 7-7: USB PORT

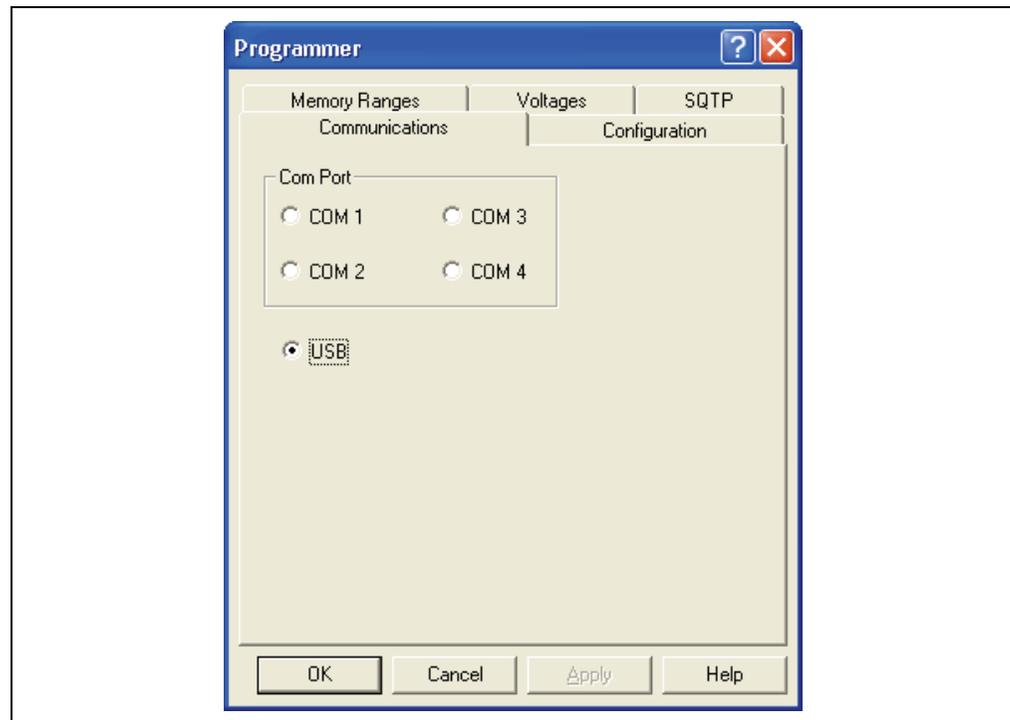

To make sure the port is set up properly, follow the instructions in the “**For USB Communications**” subsection in **Section 2.3.1 “Installing the Communications Cable”**.

7.5.4.3 SWITCHING THE COMMUNICATION MODE

If MPLAB PM3 is enabled in one mode of communication (USB or serial) and you wish to switch to the other mode, do the following:

1. Deselect the programmer in MPLAB IDE (*Programmer>Select Programmer>None*).
2. Turn the MPLAB PM3 programmer off and physically change the communications cable connection. If not already done, install the proper drivers.
3. Turn the MPLAB PM3 programmer back on.
4. Reselect the programmer (*Programmer>Select Programmer>MPLAB PM3*).
5. Select the other mode of communication (*Programmer>Settings, Communications* tab).
6. Enable the programmer (*Programmer>Enable Programmer*).

7.5.5 Configuration Tab

7.5.5.1 AUTOMATIC DOWNLOAD

To set MPLAB PM3 to automatically download any firmware updates, select *Programmer>Settings* and click on the **Configuration** tab (Figure 7-8). Then, select the Auto Download Firmware check box for new firmware to be automatically downloaded upon starting MPLAB PM3.

FIGURE 7-8: CONFIGURATION TAB

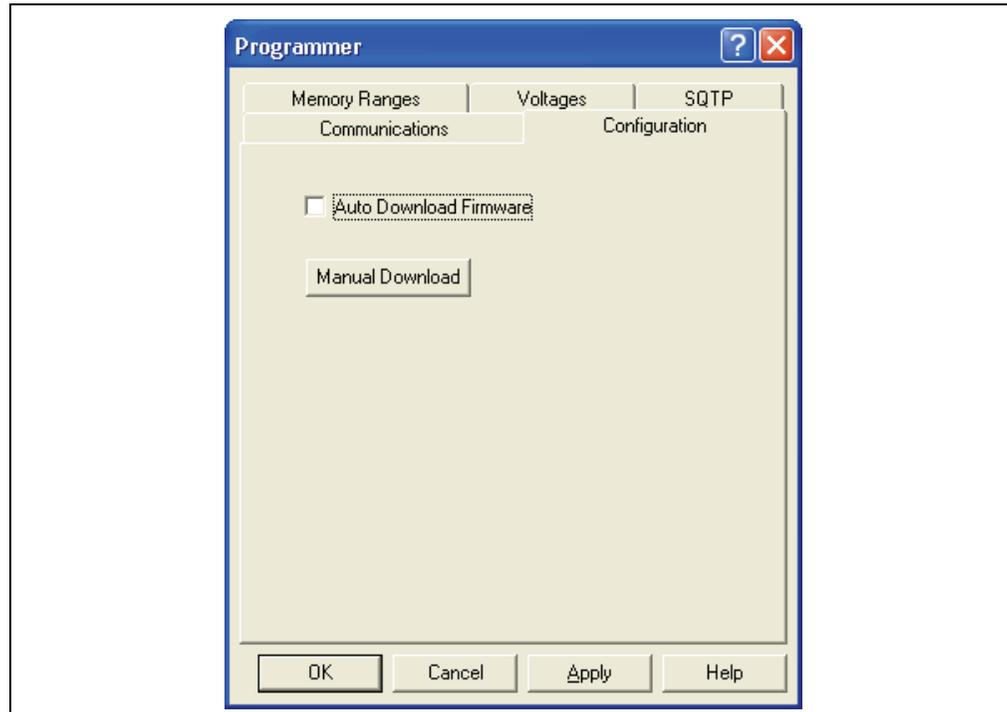

If you do not want firmware updates to automatically download, leave the checkbox empty. If there are updates available, the system will prompt to download.

7.5.5.2 MANUAL DOWNLOAD

It is recommended that MPLAB PM3 automatically detect and notify of any upgrades. Normally, it is not necessary to manually update the OS Suite for the MPLAB PM3 programmer; however, if you need to revert to an earlier OS Suite version, select *Programmer>Settings* and click on the **Configuration** tab. Then, click the **Manual Download** button. If this option is selected, the system will prompt with an auto update notice (Figure 7-9). To continue with the download, click **Yes**, or click **No** to cancel.

FIGURE 7-9: MANUAL DOWNLOAD

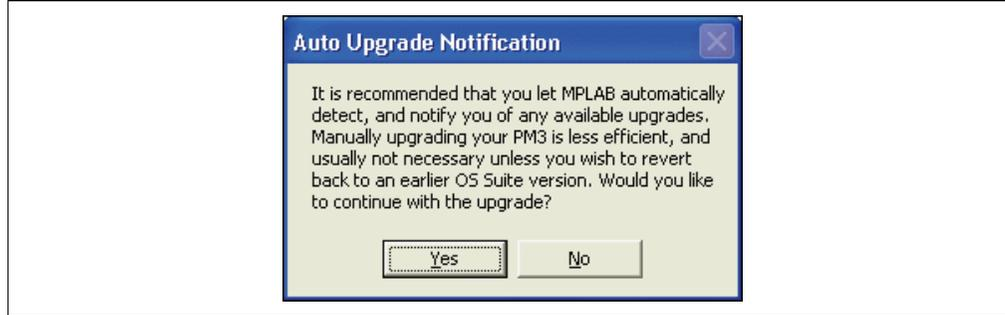

Clicking **Yes** opens a Browse window to select the appropriate file from the MPLAB IDE directory. The format of the OS Suite file is `pm3nnnnnn.mjc`, where `nnnnnn` is the OS Suite version.

7.6 SPECIAL PROGRAMMING

7.6.1 Using SQTP

Serialization of devices is done by using a series of `RETLW` (Return Literal W) instructions, with the serial number bytes as the literal data. To serialize, first generate a serialization file, and then use that file to serialize locations in the device microcontroller. Using SQTP includes these steps:

- Generating the SQTP File
- Activating Serialization
- Programming the Device

Refer to **Section 7.7.1 “Using Hexadecimal Record Formats”** for more information on hex record formats.

7.6.1.1 GENERATING THE SQTP FILE

1. Select *Programmer>Settings* and click on the **SQTP** tab to view or select the SQTP settings (Figure 7-10).

FIGURE 7-10: SQTP TAB

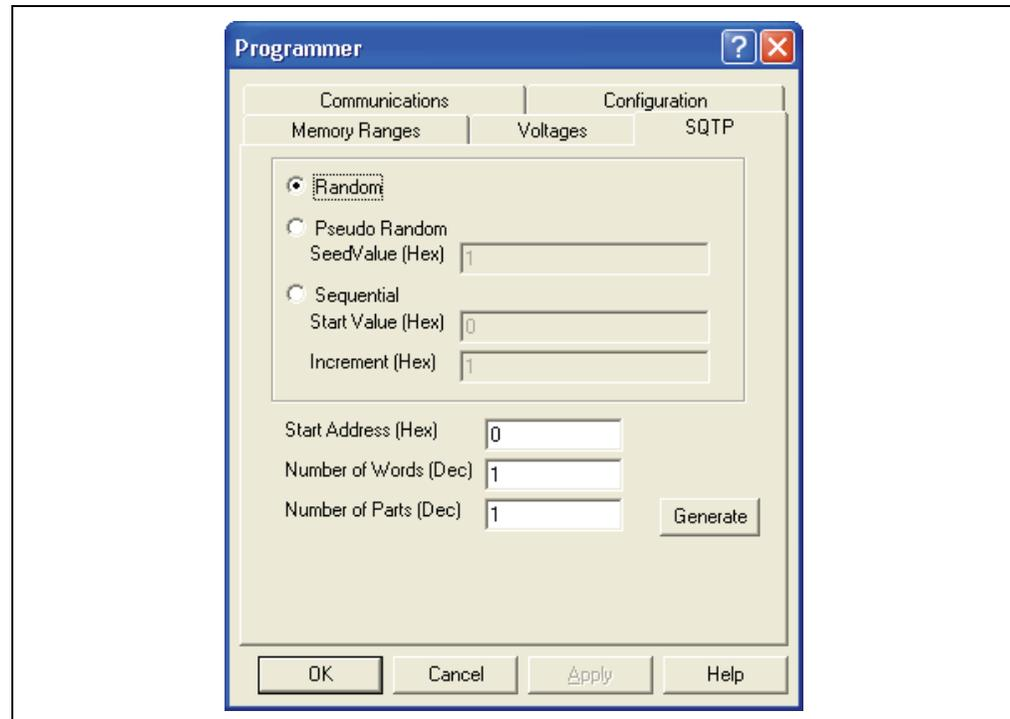

2. Fill in the appropriate values for the type of SQTP file.

TABLE 7-10: SQTP MENU

Selection	Description
Random	Select this option to generate unique, random numbers for each part.
Pseudo-Random Seed Value (Hex)	Select this option to generate a pseudo-random set of non-repeating numbers based on the seed value specified.
Sequential Start Value (Hex) Increment (Hex)	Select this option to generate sequential numbers based on the starting value specified and incrementing each number by the amount specified.
Start Address (Hex)	Enter the starting address (in hex) for the serial number.
Number of Words (Dec)	Enter the size of the serial number. Make sure a large enough serial number is specified for the number of parts planned to program using this file.
Number of Parts (Dec)	Enter the number of parts to be programmed using this file.
Generate	Opens the Save SQTP File As dialog.

3. Click **Generate**. The Save SQTP File As dialog opens.
4. Select the location and file name for the file and click **Save**.

The SQTP file will contain a line for each part; if specified for 1,000 parts or devices, the file will contain 1,000 lines, each with a unique serial number.

7.6.1.2 ACTIVATING SERIALIZATION

Select *Programmer>Load SQTP File* to choose the SQTP file to use. Click **Open** to enable serialization for the current programming session.

After enabling serialization, the serial number that will be programmed into the next device can be seen at the program memory address specified when the SQTP file was generated. Look for the RETLW instruction in the Program Memory window.

7.6.1.3 PROGRAMMING THE DEVICE

After loading the SQTP file, simply select *Programmer>Program* to program a device. When the device is programmed, the Program Memory window will display the next serial number. If the last serial number in the file has been used, a message will appear and serialization will be disabled.

When a serial number is used, the SQTP file is marked by replacing the colon for that entry with a semicolon so that MPLAB PM3 will skip that line during later programming sessions. To use the same SQTP file over multiple programming sessions without repeating any numbers, generate an SQTP file with many more parts than will be programmed in a single session. For example, if an SQTP file for 10,000 parts was generated and only 1,000 parts are programmed in each session, the file can be used ten times.

7.6.2 Using ICSP

MPLAB PM3 comes equipped with an ICSP pin header and cable. Attach the ICSP cable to the connector located between the two socket module connectors on MPLAB PM3. A socket module cannot be installed while using the ICSP connection.

<p>Note: Since MPLAB PM3 has ICSP built in, the PRO MATE II ICSP Socket Module (AC04004) and MPLAB PM3-to-PRO MATE II device adapter cannot be used.</p>

7.6.2.1 USING LOW VOLTAGE PROGRAM

MPLAB PM3 allows Low Voltage Programming (LVP) with certain PICXXFXXX Flash devices. The Flash device selected must be capable of low voltage and programming must be performed in ICSP mode. Refer to the specific device's specification and the "In-Circuit Serial Programming™ (ICSP™) Guide" (DS30277).

- Selection is transferred from MPLAB IDE to MPLAB PM3 by performing a Blank Check, read, program, verify or transfer to MPLAB PM3. Transfer from the programmer will not update the checkbox in MPLAB IDE.
- Setting of the low voltage checkbox has no impact on the enabling/disabling of the low voltage Configuration bit.

MPLAB PM3 – MPLAB IDE Reference

To use low voltage programming:

1. Select the device to program using *Configure>Select Device* and choosing the device.
2. Select and enable MPLAB PM3.
3. Go to *Programmer>Settings* and click on the **Voltages** tab.
4. In the ICSP Options area, select the Low Voltage Program checkbox (Figure 7-11).

FIGURE 7-11: LOW VOLTAGE PROGRAM OPTION

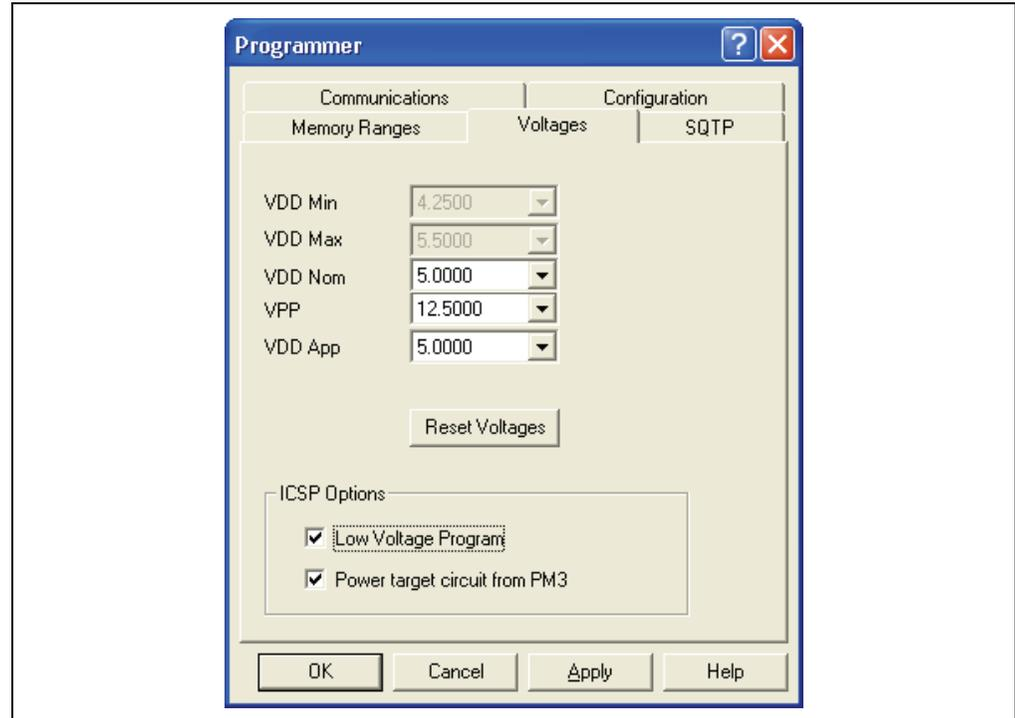

7.7 FILES USED BY MPLAB PM3

MPLAB PM3 can use information directly from MPLAB IDE projects without any intermediate steps. MPASM assembler can be used separately from MPLAB IDE to produce hex files for MPLAB PM3. Alternatively, devices can be programmed with hex files from any PICmicro MCU-compatible cross-assembler or cross-compiler.

If using MPASM assembler separate from MPLAB IDE, or generating hex files from within MPLAB IDE for use later with MPLAB PM3, use either INHX8M or INHX32 hex formats. MPASM assembler's default output format for hex files is INHX32.

If programming PIC17CXXX, PIC18CXXX or PIC18FXXX devices, use INHX32 format. See the "MPASM™ Assembler, MPLINK™ Object Linker, MPLIB™ Object Librarian User's Guide" (DS33014) for details on file formats.

7.7.1 Using Hexadecimal Record Formats

The following provides the proper file format for the PICmicro MCU device families. Make sure the assembler or compiler is configured to generate hex files in the proper format. MPLAB PM3 uses the formats described in Table 7-11.

TABLE 7-11: PICmicro® MCU DEVICE FAMILY FILE FORMATS

Device Family	File Format
PIC16C5X/6X	Uses INHX8M
PIC17CXX	Uses INHX32
PIC18XXX	Uses INHX32
Firmware Downloads	Uses INHX32

Each hexadecimal data record has the following format:
:BBAAAATTHHHH....HHCC

TABLE 7-12: HEX DATA RECORD FORMAT

Record Format	Description
:	Start character (prefix)
BB	2-digit byte count specifying the number of data blocks in a record
AAAA	4-digit starting address of the data record
TT	2-digit record type:
00 = Data record	
01 = End of file record	
02 = Segment address record	
04 = Extended linear address record (INHX32)	
HHHH....HH	2-Digit data blocks
CC	2-Digit checksum. Two's complement of the sum of all preceding bytes in the data record except the colon (start character).

INHX8M

The data record is output as described above.

INHX32

The extended linear address record is output to establish upper 16 bits of data address.

7.8 UPGRADING THE MPLAB PM3 OPERATING SYSTEM

It may be necessary to upgrade the MPLAB PM3 operating system if:

- MPLAB IDE indicates that there is a newer version of the MPLAB PM3 operating system when attempting to enable MPLAB PM3

If Automatic Update is enabled (see **Section 7.5.5 “Configuration Tab”**), the following message will appear in the Output window if an upgrade is found:

```
An upgrade for your MPLAB PM3 has been detected and is being
downloaded now.
```

If Automatic Update is disabled, the following message will appear in a message box with **Yes** and **No** options:

```
An upgrade for your MPLAB PM3 has been detected. Would you
like to upgrade now?
```

Select **Yes** to update or **No** to not allow the update.

When updating the operating system, MPLAB PM3 may click or beep a couple times while MPLAB IDE is updating the programmer.

“Downloading xx to MPLAB PM3: nn% Completed” is displayed and continually updated in the bottom of the Output window, where “xx” is either the BIOS, Operating System or Database and “nn” is a number between 0 and 100. “Downloading Now” is displayed on the MPLAB PM3 LCD, along with an activity indicator in the top right corner of the LCD. Downloading may take a couple of minutes.

When the upgrade is complete, the “Download Complete” message will display in the Output window. The MPLAB PM3 programmer is now ready to use.

The updated version of the operating system is in the MPLAB PM3 directory. The latest version of MPLAB IDE, which contains the latest MPLAB PM3 operating system can be obtained from our web site at www.microchip.com. Click Development Tools and find MPLAB PM3 listed under Hardware. Near the bottom of the MPLAB PM3 page find the latest operating system update.

MPLAB[®] PM3 User's Guide

NOTES:

Chapter 8. Stand-Alone Reference

8.1 INTRODUCTION

This chapter describes how to use the MPLAB PM3 device programmer in Stand-Alone mode. The device programmer provides an LCD interface that gives you complete control over a programming session. Topics covered in this chapter include:

- MPLAB PM3 LCD and Keys
- Start-Up Sequence
- Main Menu
- Command Menu

8.2 MPLAB PM3 LCD AND KEYS

The front panel of the programmer looks similar to Figure 8-1.

FIGURE 8-1: MPLAB® PM3 FRONT PANEL

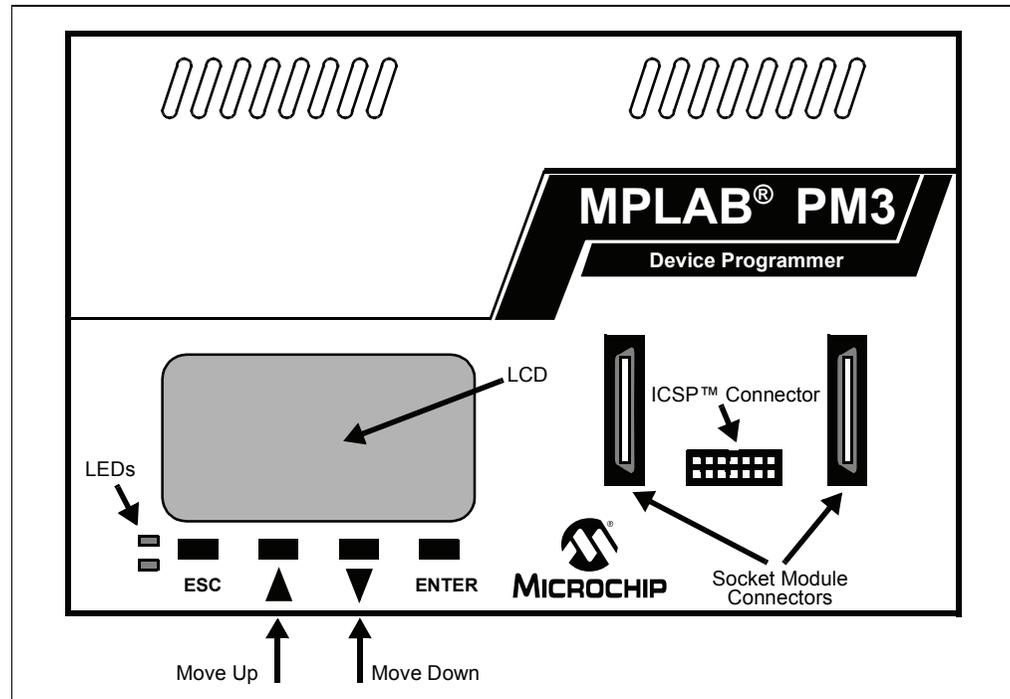

8.2.1 LCD

The graphical LCD is a 128 x 64 pixel screen which displays information on a blue background. The selection bar highlights the entire line. When you press <Enter> on a line ending with a right-pointing triangle, a submenu is displayed. When you press <Enter> on a line ending with two greater-than symbols (>>), the action is performed.

8.2.2 Keys

MPLAB PM3 provides four keys for navigation. The function of each key is:

- <ESC> – return to the previous menu or entry.
- <Up> – moves the selection bar up one line each time it is pressed.
- <Down> – moves the selection bar down one line each time it is pressed.
- <Enter> – performs the selected function.

8.3 START-UP SEQUENCE

When power is applied to the MPLAB PM3 programmer, it initiates a start-up sequence. The system performs a self-check, briefly displays the splash screen, then the versions, followed by the MPLAB PM3 Main menu. If you do not get to the Main menu, see **Appendix B. “Troubleshooting”**.

Note: If you need to update the operating system, you will have to connect to a PC with MPLAB IDE running to accomplish this.

Once the start-up sequence has completed, you will see the Main menu:

8.4 MAIN MENU

The Main menu gives you these options:

- Recently Used
- Select Device
- Programmer Settings
- Help

8.4.1 Recently Used

To display the most recently used devices:

1. Select (highlight) the “Recently Used” option and press <Enter>. Up to seven of the most recently used devices are listed.
2. To continue using this device, press <Enter>.
3. The system displays the Command menu. See **Section 8.5 “Command Menu”**.

8.4.2 Select Device

To select a specific device, you must:

1. Select (highlight) the “Select Device” option and press <Enter>.
2. Select the device family and press <Enter>.
3. Select the device and press <Enter>.
4. The system displays the Command menu. See **Section 8.5 “Command Menu”**.

8.4.3 Programmer Settings

From the Programmer Settings option on the Main menu, you can access:

- Screen Contrast
- Buzzer Volume
- Socket Information
- Checksum Calculation
- Device ID Option (Beta)
- Blank Check Override
- Go Pin Functionality

8.4.3.1 SCREEN CONTRAST

This option enables you to select the default, darker or lighter setting to adjust the contrast on your screen. Sample text lines are provided so you can see the results of your selection.

- Normal (default) – to reset the contrast to the default settings, select “Default” and press <Enter> once.
- Darker – to increase the contrast, select “Darker” and press <Enter> until you achieve the desired contrast.
- Lighter – to reduce the contrast, select “Lighter” and press <Enter> until you achieve the desired contrast.

8.4.3.2 BUZZER VOLUME

This options enables you to select the volume of the buzzer tone.

- Loud – to make the buzzer volume loud, select “Loud” and press <Enter>.
- Medium (default) – to return to the default volume, select “Default” and press <Enter>.
- Low – to make the buzzer volume low, select “Low” and press <Enter>.
- Mute – to mute the buzzer volume, select “Mute” and press <Enter>.

8.4.3.3 SOCKET INFORMATION

This option displays the socket part number and the socket ID of the socket module for the socket currently installed on MPLAB PM3.

8.4.3.4 CHECKSUM CALCULATION

With this option, you can enable or disable calculating the checksum of a code-protected device. When you select this menu option from the Main menu, a message appears asking if you want to calculate the checksum, states the current setting and offers two options (see Figure 8-2).

FIGURE 8-2: CHECKSUM CALCULATION SCREEN

```
Checksum Calculation
-----
Would you like to calculate the Code Protected Checksum
Currently: No

Do Not Calculate >>
Calculate Checksum >>
```

The default setting is “Do Not Calculate”. The setting is saved when the programmer is powered off.

Selecting the Calculate Checksum option saves time when programming or verifying larger code-protected devices such as the PIC18F8720, since the entire device does not get re-read.

If you set the checksum calculation option to “Do Not Calculate” and successfully program a code-protected device, the screen will display, “Passed! Protected csum disabled”.

If you set the checksum calculation option to “Do Not Calculate” and the program operation of a code-protected device fails, the screen will display, “Failed! CP sum disabled”.

If you set the checksum calculation option to “Calculate Checksum” for a code-protected device, the checksum will be displayed with the results of a program or verify operation.

8.4.3.5 DEVICE ID OPTION (BETA)

This option checks that the selected device is inserted in the socket module. When you select this menu option, a message appears asking if you want to check device IDs, states the current setting and offers two options (see Figure 8-3).

FIGURE 8-3: DEVICE ID OPTION SCREEN

```
Device Id Option
-----
Would you like to check device ids?
Currently: No

Test Device Ids                >>
Don't Test Device Ids          >>
```

The default setting is “Don't Test Device Ids” (“Currently: No”). The setting is saved when the programmer is powered off.

Selecting the “Test Device Ids” option verifies that the device selected through MPLAB PM3 matches the device installed in the socket module. This is helpful in avoiding programming the wrong device. The “Currently:” display changes to **Yes** when the “Test Device Ids” option is set.

8.4.3.6 BLANK CHECK OVERRIDE

Selecting this option disables the Blank Check from occurring before programming an EEPROM or 'C' device. When you select this menu option, a message appears asking if you want to override the Blank Check, states the current setting and offers two options (see Figure 8-4).

FIGURE 8-4: BLANK CHECK OVERRIDE SCREEN

```
Blank Check Override
-----
Blank check before programming 'C' devices?
Currently: Yes

Blank Check 'C' devices        >>
Override Blank Check           >>
```

The default setting is “Blank Check 'C' devices” (“Currently: Yes”). The setting is saved when the programmer is powered off.

Selecting the “Override Blank Check” enables programming C devices without first checking that they are blank. The “Currently:” display changes to **No** when the “Override Blank Check” option is set.

This setting is used if the C device is preprogrammed, for example, with oscillator values. In that case, if you performed a Blank Check, the device would fail because MPLAB PM3 would detect the preprogrammed settings. Using the override setting is helpful in those situations.

8.4.3.7 GO PIN FUNCTIONALITY

This option allows the user to change the functionality of the go pin. When you select this menu option, a message appears with the current setting and offers four options (see Figure 8-5).

FIGURE 8-5: GO PIN FUNCTIONALITY SCREEN

```

-----
Go Pin Functionality
-----
Currently:
as Program Verify
Use as PgmVfy (default)      >>
Use as Verify                >>
Use as Erase                 >>
Use as Blank Check          >>

```

The default setting is “Use as PgmVfy” (“Currently: as Program Verify”). The setting is saved when the programmer is powered off.

This feature is especially useful on the production line where speed in processing a device is required. It enables repeated operations to be performed on devices as they are automatically loaded/unloaded into the programmer. Each time the device is loaded, the Go pin is activated and the preset operation is performed.

Option	Action
Use as PgmVfy	Programs and verifies device
Use as Verify	Verifies device
Use as Erase	Erases device
Use as Blank Check	Blank checks device

The “Currently:” display changes to reflect the selected option.

8.4.4 Help

This option displays the version number of the MPLAB PM3 OS Suite running on MPLAB PM3. It also contains these submenu options:

- ICSP Connector Pinout – displays a diagram of the ICSP connector and has an option to view the pin definitions. The definition for all the ICSP pins are listed with the number, color and signal. See **Section A.4.1 “ICSP Header and Cable Pinout”**.
- Status Bar Icons – displays these icons and definitions:
 - I – ICSP Mode
 - T – Target is powered
 - V – LVP Program Entry
 - Q – SQTP file is loaded
 - O – Options Set
 - R – Ranges/Regions Set
- About – displays the name of the product and the manufacturer and has an option to view the versions. The versions for MPLAB PM3-related programs is listed.

8.5 COMMAND MENU

After a device is selected, the device programmer displays the Command menu:

- Program Verify Device
- Verify Device
- All Functions

The functions on the Command menu allow you to perform the basic user tasks for programming a microcontroller device. Pressing <ESC> repeatedly will return you to the Main menu.

8.5.1 Program Verify Device

The Program Verify Device option erases (if Flash device), programs and verifies the device (see **Section 8.5.3.7 “Settings”**).

8.5.2 Verify Device

The Verify Device option verifies that the device was programmed properly.

8.5.3 All Functions

The All Functions option displays a submenu with the selections listed in Table 8-1:

TABLE 8-1: ALL FUNCTIONS MENU

Selection	Description
Read Device	Reads the device content. Selective read (e.g., part of program memory, only Configuration bits of the device) can be done by setting up Settings below.
Program Verify Device	Programs and verifies the device.
Verify Device	Verifies that the device was programmed properly.
Blank Check Device	Checks that the device is completely blank (all bits are set to '1'). This will also check that all Configuration bits are set to '1' (unprogrammed state).
Erase Device	Erases the device in the MPLAB® PM3 device programmer. This option displays only for erasable devices.
Device Information	Displays the device name, Device ID, Device Revision, Last Checksum and the User IDs.
Settings	Sets up program/verify options, ICSP™ settings, adjust voltages, reset voltages, reset statistics count and safe mode.

8.5.3.1 READ DEVICE

If you want to copy firmware from a programmed device into an unprogrammed device, you can read the programmed firmware into MPLAB PM3 memory, then program the new device based on this information. Select “Read Device” to copy the contents of the device in the socket module into the internal memory of the device programmer.

For PIC16CXX devices, the device programmer will ask the question: “Code Protect Parts?” Answer “Yes” to code-protect the parts that you will be programming. Code protection will remain effective until a new device is read. Answer “No” to program devices exactly as read.

After reading a device, the device programmer displays a checksum. If the device is code-protected, a code protection message will be displayed prior to the read. Answer “Yes” to continue. Answer “No” to return to the Command menu.

8.5.3.2 PROGRAM VERIFY DEVICE

To program a device, select “Program Verify Device” and press <Enter>. This command programs the device in the socket module with the contents of the internal memory of the device programmer (image).

For non-Flash devices, the device programmer checks to see if the installed microcontroller device is blank. If the device is not blank, the device programmer asks if you want to continue. Answer “Yes” to continue. Answer “No” to return to the Command menu.

The device programmer programs the contents of its memory into the microcontroller device loaded in the socket module. If a hex file is not loaded into the device programmer, an event message is displayed, “Valid image not present! Please download an image or use a master device before continuing.” You must have an image in the device programmer in order to program a device. To load a hex file into MPLAB PM3, you must connect the device programmer to a PC or read from a master device. See **Section 5.2.2 “Downloading a Hex File into MPLAB PM3 Memory”**.

After programming a device without errors, the device programmer performs a check to verify the data programmed into the device and returns the results of the verification. For the installed device, the device programmer performs the verification at the VDD Minimum and VDD Maximum voltages for non-Flash devices or VDD Nominal for Flash devices.

The device programmer reports programming errors and verify errors according to where the error occurred. Errors are reported for program, Configuration bits, EEPROM data memory and ID locations. Only the first location to fail in each region is displayed. The address, expected value and read value are displayed.

After programming, the device programmer displays the checksum.

8.5.3.3 VERIFY DEVICE

To verify a device, select “Verify Device” and press <Enter>. The device programmer compares the contents of its internal memory to the contents of the programmed microcontroller device loaded in the socket module. If the data and Configuration bit settings are correct, “PASSED!” and the checksum will display on the LCD. The device programmer performs the verification at the VDD Minimum and VDD Maximum voltages for non-Flash devices and VDD Nominal for Flash devices. The device programmer reports errors according to which part of the device failed. Only the first location to fail in each region is displayed. The address, expected value and read value are displayed.

8.5.3.4 BLANK CHECK DEVICE

To perform a Blank Check, select “Blank Check Device” and press <Enter>. This check will verify that the device is completely blank (all bits are set to ‘1’) and all Configuration bits are set to ‘1’ (unprogrammed state). When completed, the programmer LCD displays “Device Blank.” Only the first location to fail in each region is displayed. The address, expected value and read value are displayed.

An OTP device cannot be erased and reprogrammed.

If the EPROM device is not blank, you will have to erase it before programming, or select another device:

1. Remove any labels covering the device window. If you do not have a windowed device, you cannot reprogram it. A windowed version of all EPROM devices may be ordered by requesting the JW package.
2. Place the device in an Ultraviolet (UV) EPROM Eraser. The amount of time required to completely erase a UV erasable device depends on: the wavelength of the light, its intensity, distance from UV source and the process technology of

the device (how small the memory cells are).

3. Before attempting to program the device, perform the Blank Check again to verify that it is blank.

Note: If the device is EEPROM or Flash, you do not have to erase it before reprogramming it. These devices are electrically erased before programming.

8.5.3.5 ERASE DEVICE

To erase a Flash device, select *All Functions>Erase Device*, press <Enter>. Press <Enter> a second time to erase the device. When completed, the LCD displays "Done."

8.5.3.6 DEVICE INFORMATION

To display device information, select *All Functions>Device Information* and press <Enter>. The system displays the device ID, device revision, last checksum and user ID. It also contains an option for "Check Code Protect". To check if the device is code-protected, press <Enter>.

8.5.3.7 SETTINGS

To display the Settings option, select *All Functions>Settings* and press <Enter>. The Settings option contains a submenu with the following options:

- Pgm/Vfy Settings
- ICSP Settings
- Adjust Voltages
- Reset Voltages
- Reset Statistics Count
- Safe Mode

8.5.3.7.1 Pgm/Vfy Settings

- Memory Ranges – Displays the memory ranges selected for the device as retrieved from an environment.
- Select Regions – Toggles the Yes/No settings for programming Program Memory, EEPROM, IDs, and Configuration bits.
- Program Options – Toggles the Yes/No settings for the program options to "Erase before Pgm" and "Preserve EEPROM".
- Reset to Defaults – Restores the default ranges, regions and options settings for the selected device.

8.5.3.7.2 ICSP Settings

These options will be available only if the selected device supports ICSP.

1. ICSP Power Source – MPLAB PM3 displays the current ICSP power source and provides two options:
 - Power from MPLAB PM3 – programming the device will be powered through MPLAB PM3.
 - Target has own supply – programming the device will be powered from the target's own power supply.
2. ICSP Programming Mode – MPLAB PM3 displays the current ICSP program mode voltage criteria and provides two options:
 - MCLR High Voltage – utilizes MCLR high voltage for programming the device.
 - PGM Pin (LVP) – utilizes the low voltage programming pin for programming the device.

8.5.3.7.3 Adjust Voltages

This option enables you to adjust the VDD nominal, VDD APP and VPP for a Flash device and VDD Max, VDD Min, VDD Nominal and VPP for an EEPROM device.

Each option displays the current setting and enables you to select “Up” or “Down”. Each time you press <Enter> the voltage setting is adjusted up or down by 0.125.

8.5.3.7.4 Reset Voltages

To reset the voltages, select *All Functions>Settings>Reset Voltages* and press <Enter>. This command resets the voltages to the default voltages.

8.5.3.7.5 Reset Statistics Count

To reset all the program statistics, select *All Functions>Settings>Reset Statistics Count* and press <Enter>. This command will reset the counters to zero.

8.5.3.7.6 Safe Mode

Safe mode was designed to prevent operational errors during production. When in Safe mode, the only functions that are allowed are Program and Verify. If any other buttons are pressed, a message is displayed stating that the system is in Safe mode and the operation is not allowed. Requesting other functions in MPLAB IDE when MPLAB PM3 is connected to the PC will deactivate Safe mode.

To enter Safe mode, select *All Functions>Settings>Safe Mode* and press <Enter>. In Safe mode, only Program and Verify options on the Command menu are available. After Safe mode is implemented, you will be sent to the Command menu.

MPLAB[®] PM3 User's Guide

NOTES:

Chapter 9. MPLAB PM3 Card Reference

9.1 INTRODUCTION

This chapter explains how to use the MPLAB PM3 Card in the MPLAB PM3 device programmer. The MPLAB PM3 Card can be accessed through the MPLAB IDE software and directly in the MPLAB PM3 programmer in Stand-Alone mode. This chapter covers only those commands specifically for the MPLAB PM3 Card. For other MPLAB IDE commands, refer to **Chapter 7. “MPLAB PM3 – MPLAB IDE Reference”**. For other Stand-Alone mode commands, refer to **Chapter 8. “Stand-Alone Reference”**.

Topics covered in this chapter include:

- MPLAB PM3 Card
- MPLAB PM3 Card Through MPLAB IDE
- MPLAB PM3 Card in Stand-alone Mode

9.2 MPLAB PM3 CARD

The MPLAB PM3 Card is a memory device that fits in the SD-MMC port on the back of the MPLAB PM3 programmer (see Figure 9-1). The card only fits into the slot one way. It can be used to store Environments that can be transferred to and from the MPLAB PM3 programmer.

FIGURE 9-1: BACK VIEW OF MPLAB® PM3

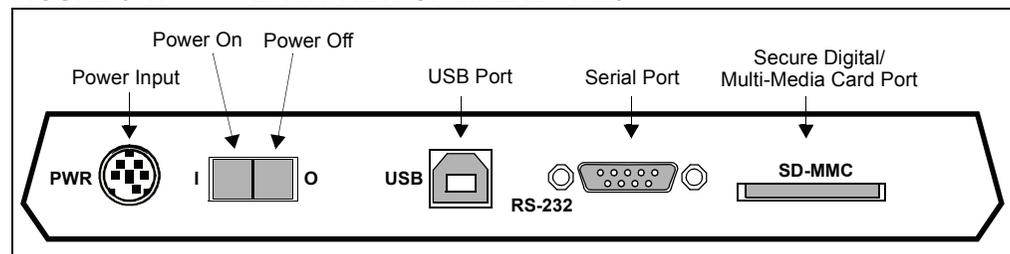

For a list of Microchip tested and recommended cards, refer to the [Readme for MPLAB PM3](#).

9.3 MPLAB PM3 CARD THROUGH MPLAB IDE

The MPLAB IDE Programmer menu contains two options for use with the MPLAB PM3 Card:

- Environment – displays a submenu of operations that can be performed on the environment.
- MPLAB PM3 Card – displays a submenu of operations that pertain to the MPLAB PM3 Card.

9.3.1 Environment

Select *Programmer>Environment* to display the submenu options (Figure 9-2).

FIGURE 9-2: ENVIRONMENT SUBMENU

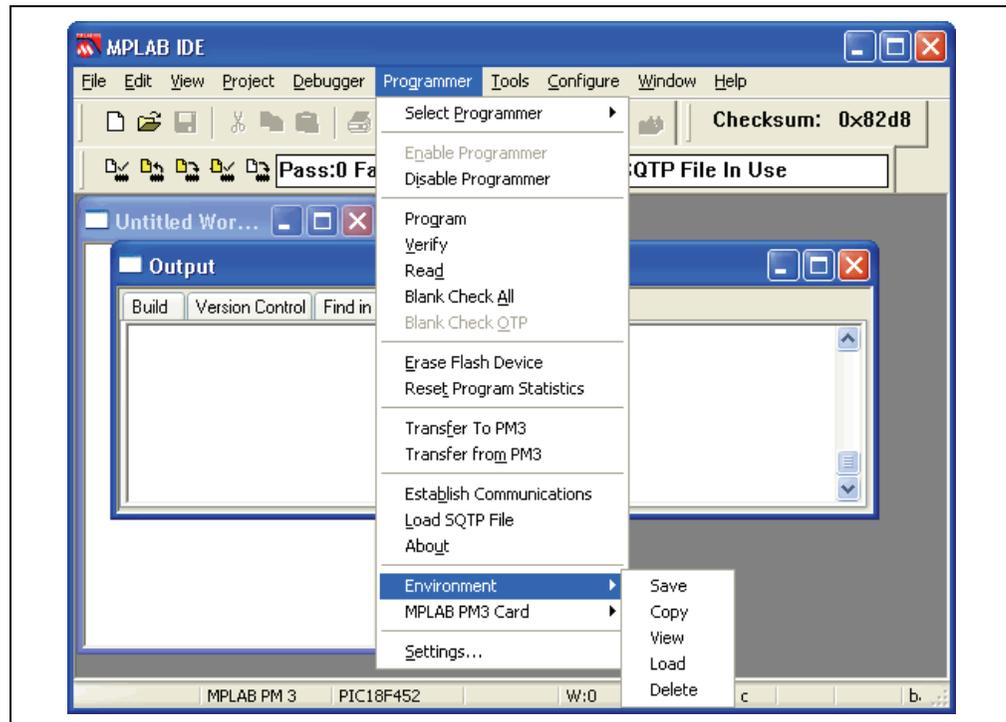

The Environment option on the MPLAB IDE Programmer menu offers several operations that can be performed through MPLAB IDE:

- Save
- Copy
- View
- Load
- Delete

9.3.1.1 SAVE

This options enables you to save an Environment to the MPLAB PM3 Card, your hard drive or another location.

Select *Programmer>Environment>Save* to open the Save Environment dialog (Figure 9-3) and perform these steps:

FIGURE 9-3: SAVE ENVIRONMENT DIALOG



1. In the “Environment Name” field, type a name (maximum 127 characters) for the Environment you wish to save.
2. If an SQTP file is specified for the device in the *Programmer>Settings>SQTP* dialog, then the SQTP file name will appear in the “SQTP File” field. The file must be generated and loaded into MPLAB IDE before saving the Environment. This is a display-only field, type cannot be entered into this field.
3. In the optional “Misc. Files” field, click **Browse** or type the file name(s) to add files you wish to save with the Environment. If typing the file name, the full path must be specified. Multiple files must be separated by a comma. A maximum number of 10 miscellaneous files (.txt, .hex, etc.) can be saved in an Environment.
4. In the optional Description field, type a brief description of the Environment.
5. Click **Browse** to open the Environment Destination window (Figure 9-4). MPLAB PM3 must be enabled for the MPLAB PM3 Card to appear in the Environment Destination window.

FIGURE 9-4: ENVIRONMENT DESTINATION WINDOW

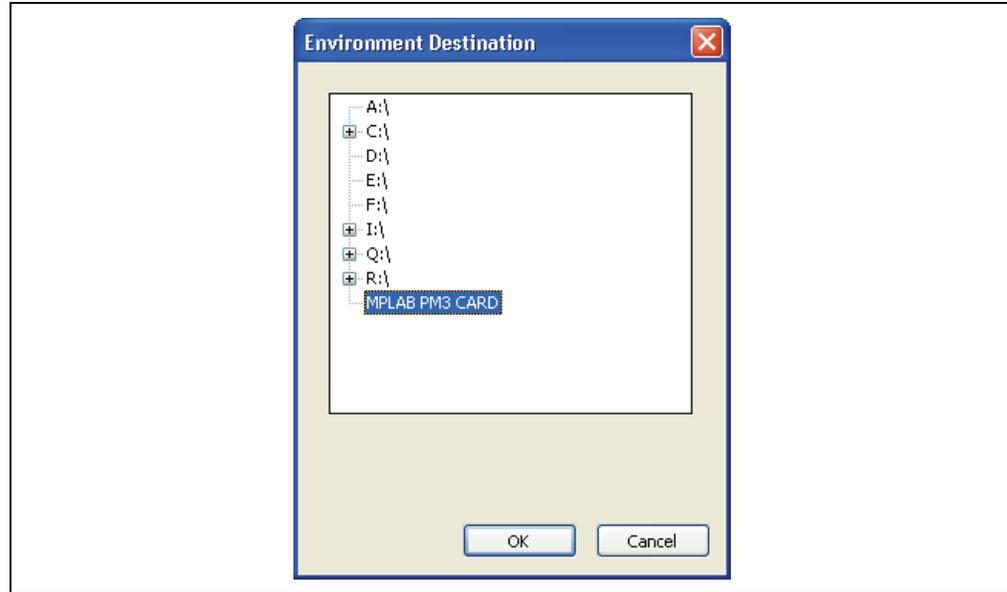

6. Select the MPLAB PM3 Card to save the Environment to the MPLAB PM3 Card, or select another destination to save it to another location. Click **OK** to close the Environment Destination window and return to the Save Environment dialog.
7. In the Save Environment dialog, the “Destination” field will display the selected location. Click **Save** to save the Environment. Click **Close** to close the dialog. The Output window displays a message confirming the Environment has been saved.

Note: In order to save the Environment, the MPLAB PM3 Card must be inserted in the programmer.

9.3.1.2 COPY

This option enables you to create a copy of the Environment so you can store it, use it in another location, or create a new Environment based on this Environment.

Select *Programmer>Environment>Copy* to open the Copy Environment dialog (Figure 9-5). This command copies an Environment from one location to another, for example, from the MPLAB PM3 Card to your hard drive. Use these steps to copy an Environment:

FIGURE 9-5: COPY ENVIRONMENT DIALOG

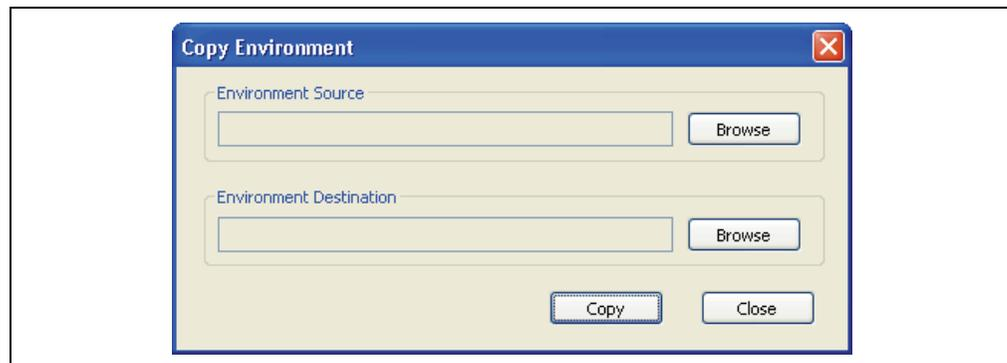

1. In the Environment Source field, click **Browse** to open the Select Environment window (Figure 9-6).

FIGURE 9-6: SELECT ENVIRONMENT WINDOW

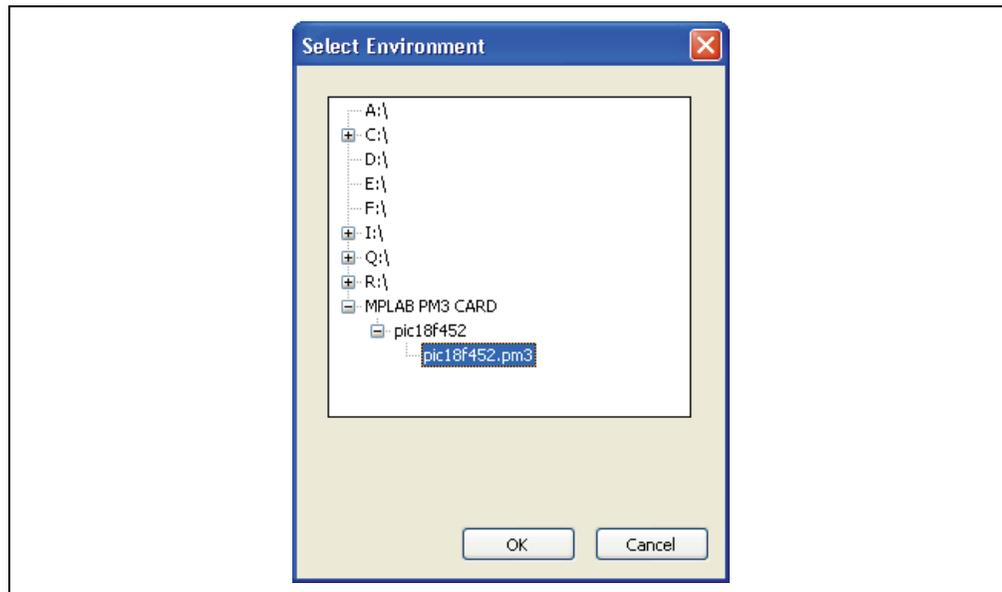

2. Locate and select the *.pm3 file you wish to copy and click **OK**. (You may have to expand the directories to locate the file you want.) The Select Environment window closes and returns you to the Copy Environment dialog. The location now displays in the “Environment Source” field.
3. In the “Environment Destination” field, click **Browse** to open the Environment Destination window (Figure 9-4).
4. Select the destination location where you wish to copy the Environment. Click **OK**, then **Close** to return to the Copy Environment dialog. The location now displays in the “Environment Destination” field.
5. Click **Copy** to perform the operation, then click **Close**. A message displays in the Output window confirming the environment was copied. When an Environment is copied, the Environment file and any other associated files are copied. A folder of the same name as the Environment file is created in the destination directory and the associated files are placed in the folder.

9.3.1.3 VIEW

Use this option to view an Environment before loading, copying or other functions.

Select *Programmer>Environment>View* to open the View Environment window (Figure 9-7). Use this dialog to view or load environments.

FIGURE 9-7: VIEW ENVIRONMENT WINDOW

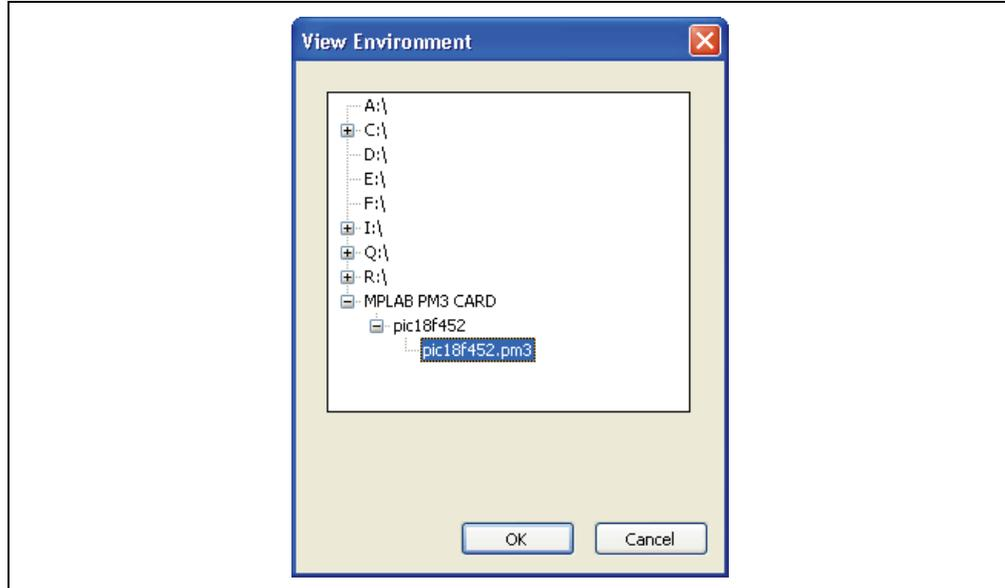

1. Select the Environment (*.pm3) you wish to view and click **OK**. (You may need to expand the directories to display the file.) The system closes the View Environment window and displays the selected Environment (see example in Figure 9-8).

FIGURE 9-8: EXAMPLE OF VIEWING AN ENVIRONMENT

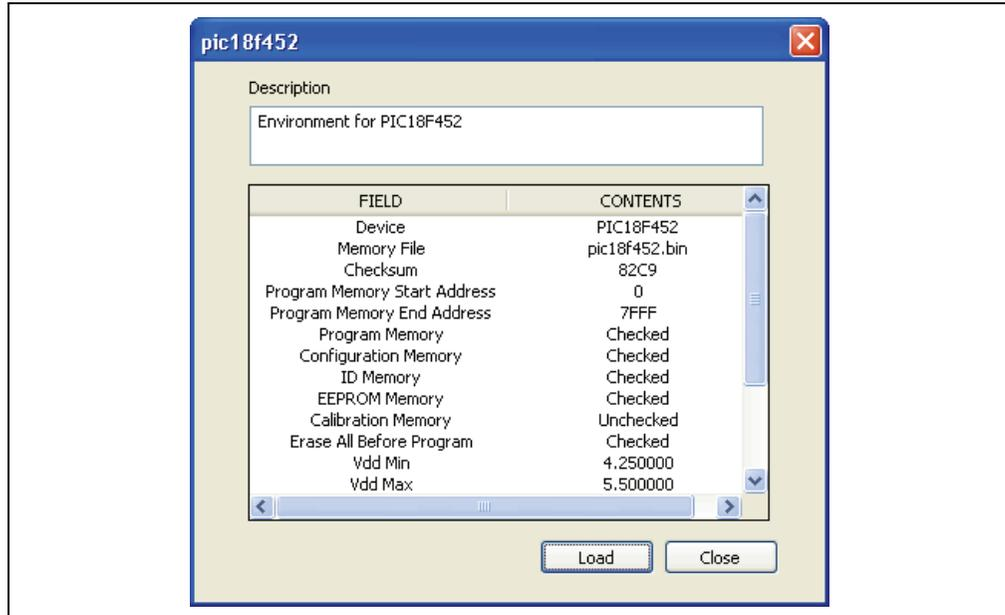

2. From here, either click **Close** or, to load the viewed Environment into MPLAB IDE, click **Load**. After the load is complete, a message displays in the Output window.

9.3.1.4 LOAD

This option load the Environment file from the MPLAB PM3 Card into the MPLAB PM3 Programmer.

Select *Programmer>Environment>Load* to open the Load Environment window (Figure 9-9).

FIGURE 9-9: LOAD ENVIRONMENT WINDOW

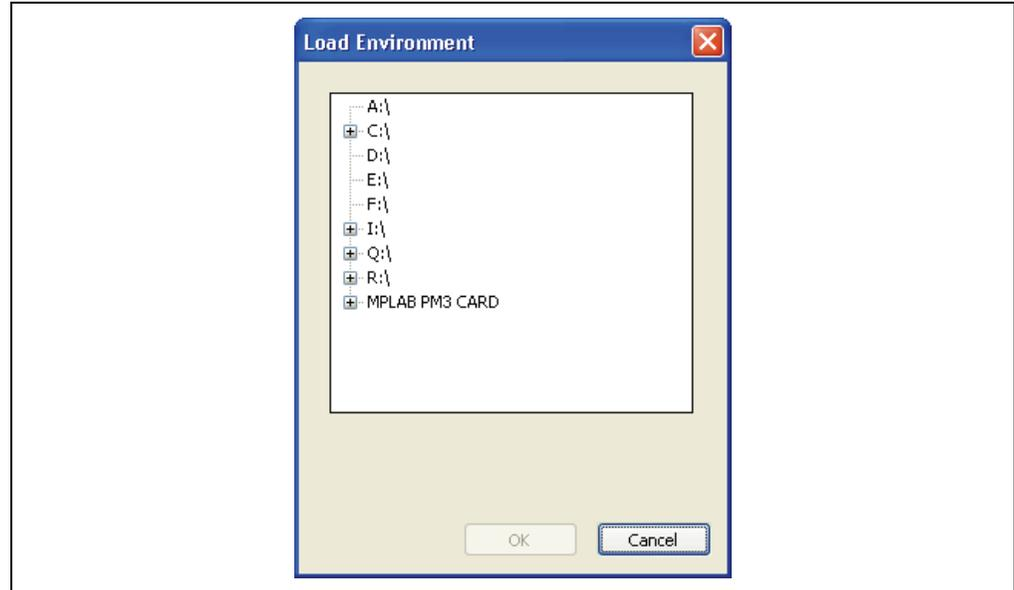

Expand the directories to display the *.pm3 files to be loaded into MPLAB IDE and click **OK**. The Environment file is loaded into MPLAB IDE and a confirmation message is displayed in the Output window.

9.3.1.5 DELETE

This option deletes the selected Environment file from the specified location. If the directory is empty after deleting the environment file, the directory is also deleted.

Select *Programmer>Environment>Delete* to open the Delete Environment window (Figure 9-10).

FIGURE 9-10: DELETE ENVIRONMENT WINDOW

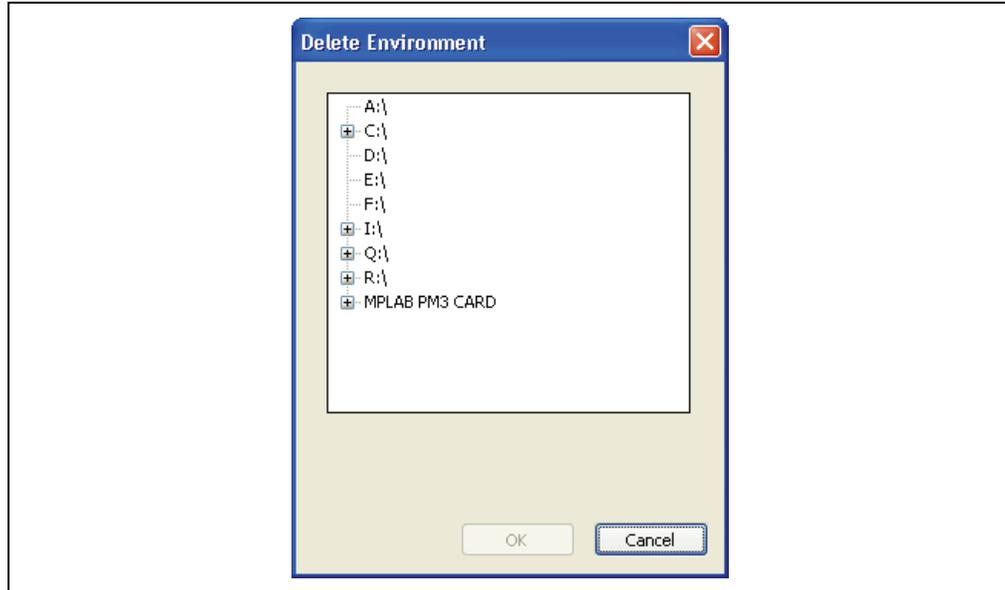

Expand the directories to display the *.pm3 file you wish to delete from the specified location and click **OK**. The environment, including any associated files, are deleted and a confirmation message is displayed in the Output window. If the directory is empty after deleting the Environment file, the directory is also deleted.

9.3.2 MPLAB PM3 Card

When the MPLAB PM3 Card is inserted and MPLAB PM3 is enabled, these MPLAB PM3 Card options are available on the MPLAB IDE Programmer menu:

- List Files
- Format
- Properties

9.3.2.1 LIST FILES

This option enables all of the files in an Environment to be viewed so the files can be reviewed before performing another action, such as loading, copying or deleting.

Select *Programmer>MPLAB PM3 Card>List Files* to open the List Files window (see example in Figure 9-11). Expand the directories to display all the files. Click **OK** or **Close** after viewing the listing.

FIGURE 9-11: LIST FILES WINDOW

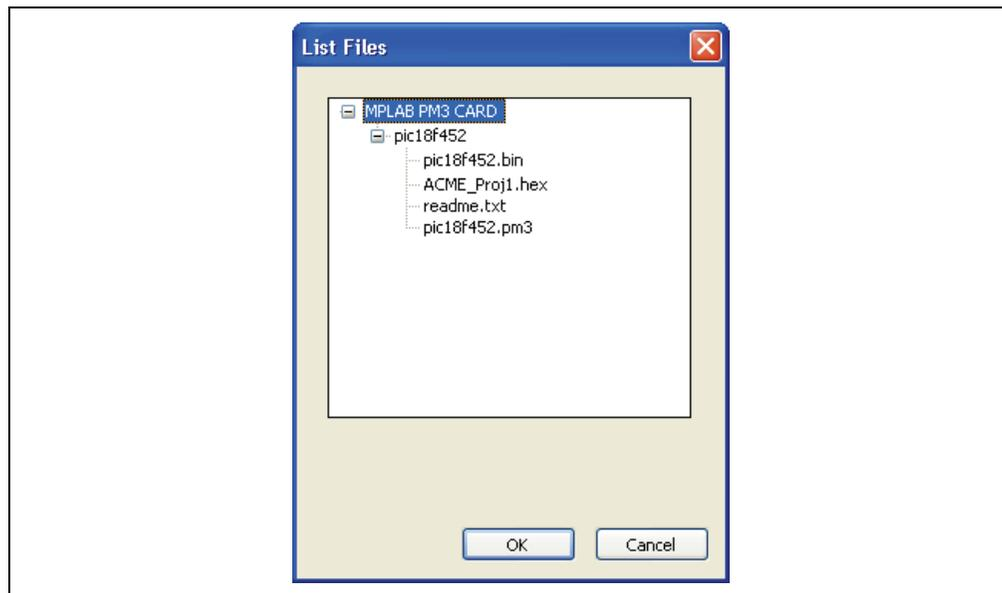

9.3.2.2 FORMAT

This option reformats MMC cards in the FAT16 format. If the card is not in FAT16 format, a warning message displays on the LCD screen:

```
MPLAB PM3 only supports FAT16.  
Would you like to format now as FAT16?  
DATA WILL BE DESTROYED!
```

Press <ENTER> to reformat a non-FAT16 card.

For FAT16 cards, with the MPLAB PM3 Card inserted in the programmer, select *Programmer>MPLAB PM3 Card>Format* to open the Format PM3 Card dialog (Figure 9-12).

FIGURE 9-12: FORMAT PM3 CARD DIALOG

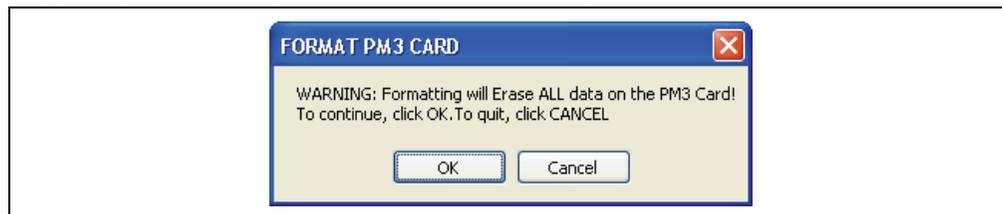

Click **OK** to continue formatting the MPLAB PM3 Card or click **Cancel**. When formatting the MPLAB PM3 Card, all data is erased from the card.

9.3.2.3 PROPERTIES

This option lists information about the inserted MPLAB PM3 Card, including capacity, number of free bytes, used bytes and cluster size.

Select *Programmer>MPLAB PM3 Card>Properties* to display the properties in the Output window (see example in Figure 9-13).

FIGURE 9-13: MPLAB® PM3 CARD PROPERTIES

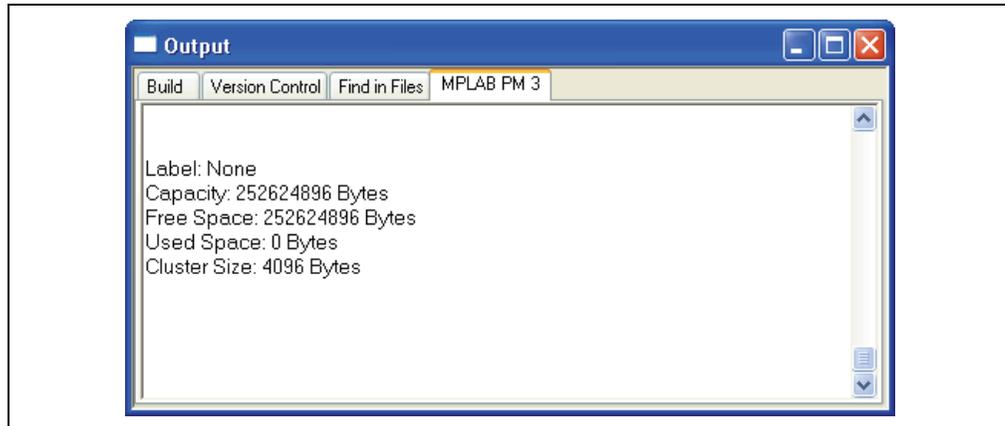

9.4 MPLAB PM3 CARD IN STAND-ALONE MODE

There are two ways to access the MPLAB PM3 Card in through the MPLAB PM3 programmer in Stand-Alone mode:

- through the MPLAB PM3 Card Menu from the Main menu
- through the All Functions Menu after a device is selected

9.4.1 MPLAB PM3 Card Menu

In Stand-Alone mode, with the MPLAB PM3 Card inserted, the Main menu has several options:

- Recently Used (see **Section 8.4.1 “Recently Used”**)
- Select Device (see **Section 8.4.2 “Select Device”**)
- MPLAB PM3 Card
- Programmer Settings (see **Section 8.4.3 “Programmer Settings”**)
- Help (see **Section 8.4.4 “Help”**)

After you select the MPLAB PM3 Card from the Main menu, the device programmer displays the MPLAB PM3 Card command menu:

- Load an Environment
- View an Environment
- View Disk Contents
- Open a Text File
- Card Properties

The functions on the Command menu allow you to perform the basic user tasks for programming a microcontroller device. Pressing <ESC> repeatedly will return you to the Main menu.

9.4.1.1 LOAD AN ENVIRONMENT

The Load an Environment option loads the Environment into the MPLAB PM3 programmer from the MPLAB PM3 Card. The Environment includes the associated BIN file, the memory, voltage, ICSP settings and the optional SQTP file.

<p>Note: Program ranges, erase options and memory region settings are not used in Stand-Alone mode.</p>
--

9.4.1.2 VIEW AN ENVIRONMENT

The View an Environment option displays the contents and settings of an Environment. You can only view the Environment using this option.

9.4.1.3 VIEW DISK CONTENTS

The View Disk Contents option displays the contents of the MPLAB PM3 Card inserted in the MPLAB PM3 programmer. Directories (designated with a folder icon) can be expanded further by pressing <ENTER>.

9.4.1.4 OPEN A TEXT FILE

The Open a Text File (*.txt) option displays the first couple hundred characters of a text file.

9.4.1.5 CARD PROPERTIES

Displays the card's byte capacity, bytes free, bytes used and cluster size.

9.4.2 All Functions Menu

Once a device is selected, the device's menu is displayed:

- Program Verify Device (see **Section 8.5.1 “Program Verify Device”**)
- Verify Device (see **Section 8.5.2 “Verify Device”**)
- All Functions

When the MPLAB PM3 Card is inserted, the All Functions option displays a submenu with the selections listed in Table 9-1. Note that there is an additional option for the MPLAB PM3 Card at the end of the list. For all other functions listed, refer to **Section 8.5.3 “All Functions”**.

TABLE 9-1: ALL FUNCTIONS MENU

Selection	Description
Read Device	Reads the device content. Selective read (e.g., part of program memory, only Configuration bits of the device) can be done by setting up Settings below.
Program Verify Device	Programs and verifies the device.
Verify Device	Verifies that the device was programmed properly.
Blank Check Device	Checks that the device is completely blank (all bits are set to '1'). This will also check that all Configuration bits are set to '1' (unprogrammed state).
Erase Device	Erases the device in the MPLAB® PM3 device programmer. This option displays only for erasable devices.
Device Information	Displays the device name, Device ID, Device Revision, Last Checksum and the User IDs.
MPLAB PM3 Card	Displays a submenu of operations that pertain to the MPLAB PM3 Card.
Settings	Sets up program/verify options, ICSP™ settings, adjust voltages, reset voltages, reset statistics count and Safe mode.

The MPLAB PM3 Card function displays these options:

TABLE 9-2: MPLAB® PM3 CARD FUNCTIONS

Load an Environment	Loads the Environment into the MPLAB PM3 programmer from the MPLAB PM3 Card
View an Environment	The View an Environment option displays the contents and settings of an Environment. You can only view the Environment using this option.
Card Properties	Displays the card's byte capacity, bytes free, bytes used and byte cluster.

Appendix A. Hardware Specifications

A.1 INTRODUCTION

This appendix describes MPLAB PM3 to PC connections, programmer hardware and socket module hardware. Contents of this appendix include:

- Connecting to a PC via the Serial Port
- Programmer Specifications
- ICSP Hardware Specifications
- Socket Module Specifications

A.2 CONNECTING TO A PC VIA THE SERIAL PORT

MPLAB PM3 interfaces to the PC via a standard RS-232 port with a DB9 connector. The unit defaults to a 57.6K baud rate.

Serial port communications are as follows:

- 57.6K (default) or 9.6K baud (PROCMD only)
- 8 data bits, 1 stop bit, no parity
- Hardware flow control

Table A-1 gives the data for connecting the MPLAB PM3 programmer (9-pin straight-through) to a 25-pin serial port. Connect the corresponding terminals indicated on each line of the table.

TABLE A-1: PC HOST TO MPLAB® PM3 SIGNALS

25-pin (PC-Host)		9-pin (MPLAB PM3)	
2	TX	2	RX
3	RX	3	TX
20	DTR	4	DTR
7	Common	5	Common
6	DSR	6	+5 volts (pulled up)
4	RTS	7	CTS
5	CTS	8	RTS

MPLAB® PM3 User's Guide

A.3 PROGRAMMER SPECIFICATIONS

This section discusses the following topics:

- Physical Dimensions and Layout
- General Specifications

Note: Values are specified under normal operation and represent recommended operating conditions. Absolute maximum ratings have not been published at this time.

A.3.1 Physical Dimensions and Layout

The MPLAB PM3 device programmer has the physical dimensions of 8 3/8" L x 6 5/16" W x 13/16" H. Top and back views of the programmer are shown in Figure A-1 and Figure A-2, respectively.

FIGURE A-1: MPLAB® PM3 TOP VIEW

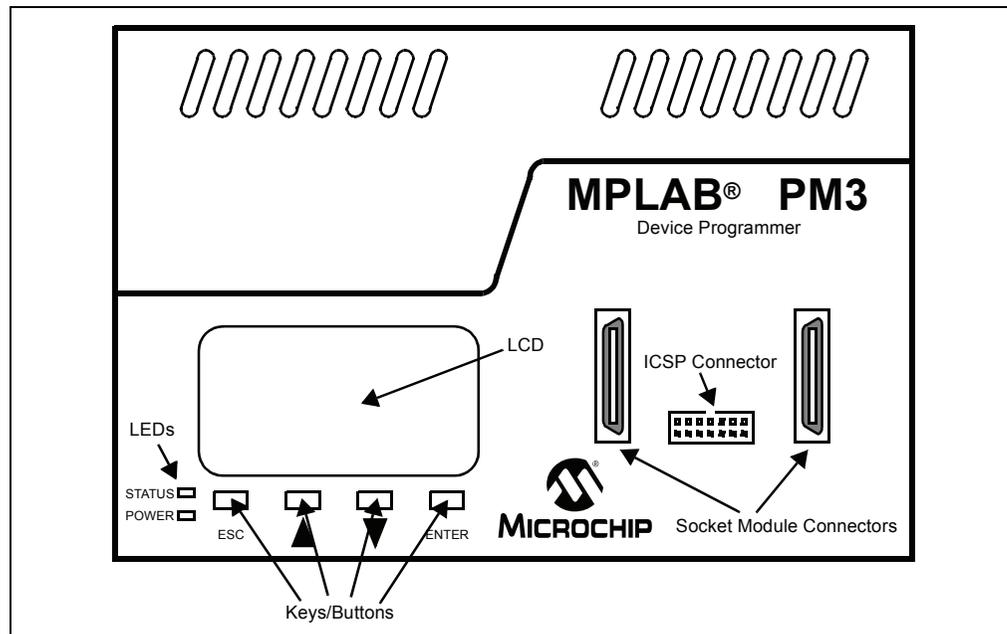
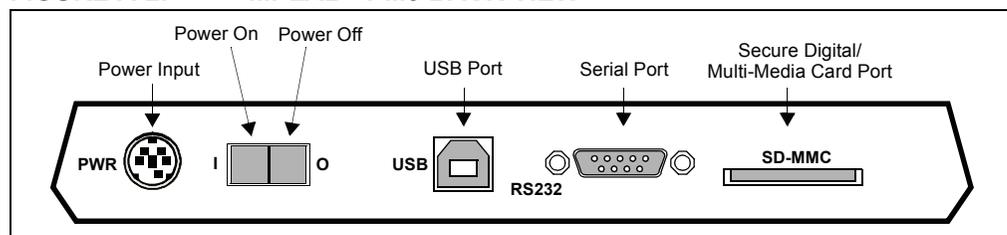

FIGURE A-2: MPLAB® PM3 BACK VIEW



A.3.2 General Specifications

TABLE A-2: GENERAL SPECIFICATIONS

Component	Description
Power Supply	20.3W Dual Output +3.3VDC/5A, +5.0VDC/0.75A, w/ 5-pin Mini Din plug
USB Cable	USB A-B M-M cable, 6 feet
Serial Cable	RS-232 DB9 (1 end male, 1 end female)
ICSP™ Cable	18" 15-pin, 22 AWG Super Flex Stranded Series 200 wire leads with 2 x 7 keyed housing
Pin Drivers	40 Universal pin drivers capable of supplying VDD, VPP, I/O, Ground
Diagnostics	Power supply, CPU's, FPGA, CPLD

A.4 ICSP HARDWARE SPECIFICATIONS

This section covers:

- ICSP Header and Cable Pinout
- ICSP VDD/VPP Operating Characteristics
- MPLAB PM3 Handler Operating Characteristics

A.4.1 ICSP Header and Cable Pinout

MPLAB PM3 comes equipped with an ICSP pin header and cable. You can locate this under where a socket module would be installed. The header configuration can be found in Figure A-3 (viewed from above MPLAB PM3) and the cable color and signal designations are listed in Table A-3.

FIGURE A-3: ICSP™ HEADER CONFIGURATION

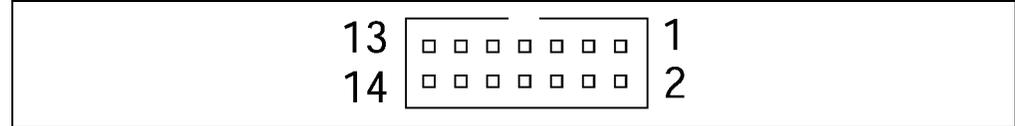

TABLE A-3: ICSP™ CABLE PINOUT

Pin	Color	Signal
1	Violet	CLK
2	Green	PASS
3	Orange	DATA
4	Brown	FAIL
5	White	LVP/Clock
6	Blue	\overline{GO}
7	Yellow	VPP
8	Yellow	VPP
9	Red	VDD
10	White with blue stripe	Test
11	Red	VDD
12	Gray	+5V
13	Black	GND
14	Black	GND

Information on using ICSP for a specific device is described in the device's programming specification. You can find programming specifications on the Microchip web site.

Note: Since MPLAB PM3 has ICSP built-in, you cannot use the PRO MATE II ICSP Socket Module (AC04004) and the MPLAB PM3-to-PRO MATE II device adapter.

A.4.2 ICSP VDD/VPP Operating Characteristics

TABLE A-4: POWER VIA MPLAB[®] PM3

Parameter	Value
VPP Range	9-14V in 125 mV steps
IPP Range	150 mA max
VDD Range	2-5.5V in 125 mV steps
IDD Range	500 mA max
Protection	Over Voltage Shutdown

TABLE A-5: POWER VIA TARGET

Parameter	Value
Target VDD Range	2-5.5V
VPP Range	9-14V in 125 mV steps
IPP	-150 mA max
Target VDD Range	2-5.5V
Protection	IPP Overcurrent Fuse, Over Voltage Shutdown

Note: The use of any cable (other material, length...) other than the one provided with MPLAB PM3 unit may result in unreliable device programming.

TABLE A-6: ICSP™ I/O OPERATING CHARACTERISTICS

Parameter	Conditions	VDD	Min	Max
VDD	Supply Voltage Range		2.00	5.50
VIH	Minimum High-level Input Voltage	2.0	1.50	
		3.0	2.10	
		5.5	3.85	
VIL	Maximum Low-level Input Voltage	2.0		0.50
		3.0		0.90
		5.5		1.65
VOH	Minimum High-level Output Voltage @ IOH = -50 µA	2.0	1.90	
		3.0	2.90	
		4.5	4.40	
VOL	Maximum Low-level Output Voltage @ IOL = 50 µA	2.0		0.10
		3.0		0.10
		4.5		0.10
IOH	High-level Output Current	2.00		-50 µA
		3.3		-4 mA
		5.0		-8 mA
IOL	Low-level Output Current	2.00		-50 µA
		3.3		-4 mA
		5.0		-8 mA
tR, tF	Rise/Fall Times			50 nS
tPD	Propagation Delay CI = 50 pF		1 nS	5.5 nS

A.4.3 MPLAB PM3 Handler Operating Characteristics

TABLE A-7: PASS/FAIL SIGNALS

Parameter	Conditions	Vcc	Min	Max
VOH	Minimum High-level Output Voltage @ IOH = -5.2 mA	5.0	4.50	
VOL	Maximum Low-level Output Voltage @ IOL = 5.2 mA	5.0		0.26
IOH	High-level Output Current	5.0		-20 mA
IOL	Low-level Output Current	5.0		20 mA

TABLE A-8: $\overline{\text{GO}}$ SIGNAL

Parameter	Conditions	Vcc	Min	Max
VIH	Minimum High-level Input Voltage	5.0	3.50	
VIL	Maximum Low-level Input Voltage	5.0		1.50

Note: The $\overline{\text{GO}}$ signal has internal 10K pull-up to +5.0V and a 0.1 µF cap to GND.

A.5 SOCKET MODULE SPECIFICATIONS

This section discusses the following topics:

- Socket Specifications
- MPLAB PM3 Socket Module Insertion
- Compatibility with MPLAB PRO MATE II Socket Modules
- Socket Life Expectancy and Cleaning Method
- Typical Programming Times

A.5.1 Socket Specifications

TABLE A-9: SOCKET V_{DD}/V_{PP} OPERATING CHARACTERISTICS

Parameter	Value
V _{PP} Range	9-14V in 125 mV steps
I _{PP} Range	150 mA max
V _{DD} Range	2-5.5V in 125 mV steps
I _{DD} Range	500 mA max
Protection	Overcurrent Shutdown

TABLE A-10: SOCKET I/O OPERATING CHARACTERISTICS

Parameter	Conditions	V _{CC}	Min	Max
V _{CC}	Supply Voltage Range		2.00	5.50
V _{IH}	Minimum High-level Input Voltage	2.0	1.50	
		3.0	2.10	
		4.5	3.15	
		5.5	3.85	
V _{IL}	Maximum Low-level Input Voltage	2.0		0.50
		3.0		0.90
		4.5		1.35
		5.5		1.65
V _{OH}	Minimum High-level Output Voltage @ I _{OH} = -50 μA	2.0	1.90	
		3.0	2.90	
V _{OL}	Maximum Low-level Output Voltage @ I _{OL} = 50 μA	2.0		0.10
		3.0		0.10
		4.5		0.10
I _{OH}	High-level Output Current	1.65		-4 mA
		2.3		-8 mA
		3.0		-24 mA
		4.5		-32 mA
I _{OL}	Low-level Output Current	1.65		4 mA
		2.3		8 mA
		3.0		24 mA
		4.5		32 mA

A.5.2 MPLAB PM3 Socket Module Insertion

MPLAB PM3 utilizes socket modules to accommodate various Microchip devices. MPLAB PM3 socket modules have two interface connectors on the programmer. (Figure A-4).

FIGURE A-4: SOCKET MODULE ALIGNMENT

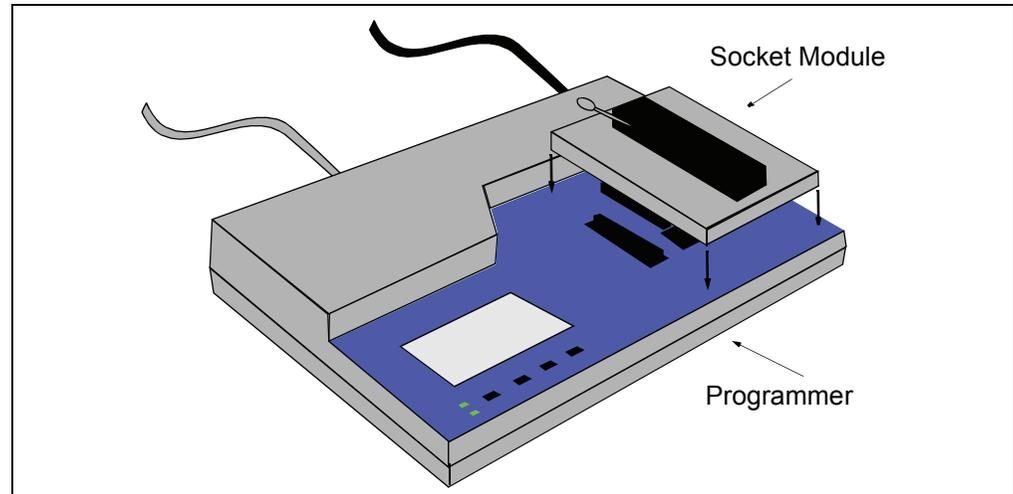

A.5.3 Compatibility with MPLAB PRO MATE II Socket Modules

MPLAB PM3 can accept PRO MATE II socket modules with the use of an adapter module.

CAUTION

Do not attempt to connect the PRO MATE II ICSP socket module to MPLAB PM3.

A.5.4 Socket Life Expectancy and Cleaning Method

Microchip uses socket modules from several manufacturers. Table A-11 gives the expected life (in number of automatic insertions) and cleaning method for each socket module as reported by the manufacturer.

TABLE A-11: SOCKET LIFE EXPECTANCY AND CLEANING METHOD

Manufacturer	Insertions	Cleaning Method
Aries	10,000	None
AMP (18 pin)	25,000	None
3M Textool	10,000	Methyl Alcohol
Yamaichi	25,000	Methyl Alcohol

A.5.4.1 MANUFACTURER

All sockets (except Yamaichi) are labeled with the manufacturer's name. Identify a Yamaichi socket by looking for the letters IC51- (as the prefix to a part number) on the socket.

A.5.4.2 INSERTIONS

The expected life for manual insertions has been found to be less than the manufacturer's reported number. The number of manual insertions depends on the socket condition and how often the socket is cleaned.

Careless insertions or dirty socket conditions can bring the number of insertions down to less than 5,000. Cleanliness and care in inserting devices into a socket are most important with surface mount devices because the socket contacts must remain planar to function properly.

Any bent or nonplanar contacts will result in a failure. Nonplanar socket module contacts occur earlier in the life of a socket module when devices are inserted manually into a socket module. Early contact failure from manual insertions is due to the non repeatability of the manual insertion method. Therefore, the listed number of insertions might not be reached for sockets if devices are inserted manually. No good method exists to ensure that the contacts are planar.

A.5.4.3 CLEANING METHOD – METHYL ALCOHOL

Clean with methyl alcohol, then blow off the contacts with dry compressed air.

DANGER
Methyl alcohol is highly flammable. Use methyl alcohol in a well ventilated area away from sparks, flames or any other source of ignition. Methyl alcohol is poisonous and may cause blindness if taken internally. Avoid inhaling methyl alcohol vapor.

A.5.5 Typical Programming Times

Table A-12 shows typical programming times for MPLAB PM3 when used in Stand-Alone mode. Results may vary when programming through MPLAB IDE.

TABLE A-12: TYPICAL PROGRAMMING TIMES IN STAND-ALONE MODE

Device	Programming Time
PIC12F675	4 seconds
PIC16F877A	5 seconds
PIC16F819	4 seconds
PIC18F452	7 seconds
PIC16F88	3.7 seconds
PIC16C55A	2.5 seconds
PIC17C44	10 seconds
PIC12C509	4 seconds
PIC16F77	6.6 seconds
PIC16F877	37 seconds
PIC18F8720	24 seconds

Appendix B. Troubleshooting

B.1 INTRODUCTION

The troubleshooting information in this chapter can help you resolve typical problems or obstacles in programming microcontroller devices. Topics covered in this appendix:

- Troubleshooting Hardware
- Troubleshooting Operational Problems
- Troubleshooting Software
- Common Problems
- Error Messages – PC
- Error Messages – LCD
- Limitations

B.2 TROUBLESHOOTING HARDWARE

Some problems involving the hardware include:

- Communication Failure
- Ensuring Proper Socket Module Contact
- Socket Module Failure

B.2.1 Communication Failure

Appendix A. “Hardware Specifications” gives the data for connecting the MPLAB PM3 Device Programmer to a communications port. If communication fails, check your communications port.

B.2.2 Ensuring Proper Socket Module Contact

After changing a socket, insert a blank device and do a Blank Check to ensure the socket is making proper contact. A blank device will show erased. An improperly seated module socket may cause a device to fail the Verify process with errors claiming that the bad data is all zeros (0000).

B.2.3 Socket Module Failure

If you can program a master chip, and if you can read and try to program code-protected chips, but the chips fail the programming attempts, then potential socket pin damage may be the cause of the problem. Contact your Microchip Field Application Engineer (FAE) if your socket module is not operating properly.

B.3 TROUBLESHOOTING OPERATIONAL PROBLEMS

Problems involving the basic operation of MPLAB PM3 include:

- Reading a Device Master in Stand-Alone Mode
- Device Pin Damage

B.3.1 Reading a Device Master in Stand-Alone Mode

When reading a device master in Stand-Alone mode, the Device Programmer asks the question: "Code Protect Parts" being programmed. Answer **Yes** to code-protect the parts that you will be programming.

B.3.2 Device Pin Damage

On the smaller device packages (SSOP, PQFP and SOIC) the pins can bend easily and cause problems in programming the devices.

B.4 TROUBLESHOOTING SOFTWARE

Some problems involving the software include:

- Establishing Communication with MPLAB PM3
- No MPLAB PM3 Menu Visible
- Default Serial Port
- Operating System Update Needed

B.4.1 Establishing Communication with MPLAB PM3

MPLAB IDE attempts to establish communication with MPLAB PM3 when you enable the programmer. If communication cannot be established, no programming can occur. A dialog box appears if the attempt to establish communication fails. If you encounter communications problems, review the following information.

B.4.1.1 SERIAL PORT COMMUNICATIONS

1. Windows 98 and Windows 2000 require special attention when setting up COM ports. If you suspect a driver-hardware incompatibility, try changing Flow Control to Hardware and/or turning off the FIFO for the serial port. This is done in the Control Panel.
In Windows 98, click the System Icon. Click the **Device Manager** tab and click **Ports**. If necessary, expand the Ports selection by clicking the '+' sign next to it. Double click the I/O port that MPLAB PM3 is connected to. This is where you can set flow control to Hardware. To turn off FIFO, click the **Advanced** button, deselect the Use FIFO box and click **OK**. Restart the PC.
2. In Windows 2000, click the System Icon. Click the **Hardware** tab and click the **Device Manager** button. If necessary, expand the Ports selection by clicking the '+' sign next to it. Double click the I/O port that MPLAB PM3 is connected to. This is where you can set flow control to Hardware. To turn off FIFO, click the **Port Settings** tab and click the **Advanced** button. Deselect the Use FIFO box and click **OK**. Restart the PC.
3. Make sure that the RS-232 cable is connected, the power supply is connected and the power switch on MPLAB PM3 is on.
4. Try connecting MPLAB PM3 to a different serial port. If your PC has a 25-pin serial port, you will need a 25-to-9 serial port adapter.

5. Make sure that a COM port is properly set up exclusively for use by MPLAB PM3. Check the resources to ensure they are operating properly and that there are no conflicts with other devices. This commonly happens when you have a modem or other serial device that is improperly configured. Consult your Windows manual or other reference literature. You can try removing, reconfiguring or disabling the conflicting device, but do so only if you are familiar with those procedures.
6. Some system errors are caused by driver and hardware incompatibility.
7. You must use the Microsoft Windows communications driver that is native to the version of Windows that you use.
8. Make sure you are not using a third party communications driver. Open your `SYSTEM.INI` file and look for the line in the [OPTIONS] section that reads
`COMM.DRV=COMM.DRV`
If this line reads differently, you are using a different communications driver.

B.4.2 No MPLAB PM3 Menu Visible

If you have been using another programmer (e.g., PICSTART Plus), the MPLAB PM3 menu might not be available. Select *Programmer>Select Programmer* to open the Select Programmer dialog and choose MPLAB PM3 from the list. After you select the programmer, MPLAB IDE will issue you a warning prompt and shut itself down. MPLAB IDE must be restarted before the programmer options are available. The MPLAB PM3 menu will appear on the menu bar when MPLAB IDE is restarted.

B.4.3 Default Serial Port

MPLAB PM3 uses COM1 as the default serial port the first time you run MPLAB PM3. If you change your serial port selection with the *Programmer>Communications Port Setup* command, then the next time you run MPLAB PM3, the host software will use the same serial port used in the previous session.

B.4.4 Operating System Update Needed

If the device you selected when setting up the development mode in MPLAB IDE is not supported by the MPLAB PM3 Operating System, a message box will appear when you try to enable the programmer.

Make sure you allow MPLAB PM3 to upgrade to get the latest versions for MPLAB IDE software and MPLAB PM3 operating system (**Section 7.8 “Upgrading the MPLAB PM3 Operating System”**).

B.5 COMMON PROBLEMS

Some common problems you may have include:

- Failure to Establish Communication with Programmer
- Advanced Serial Communications Help
- Device Pin Damage (see **Section B.3.2 “Device Pin Damage”**)
- No Programmer Options Visible (see **Section B.4.2 “No MPLAB PM3 Menu Visible”**)
- MPLAB PM3 Card Option Not Available on Programmer Menu

B.5.1 Failure to Establish Communication with Programmer

MPLAB IDE attempts to establish communication with the programmer upon Enable Programmer selection. If communication cannot be established, no programming can occur. If the attempt to establish communication fails, it is reported in the Output window.

- General Communications Troubleshooting
- Serial Communications
- USB Communications

B.5.1.1 GENERAL COMMUNICATIONS TROUBLESHOOTING

1. Check that the RS-232 or USB cable is connected securely to MPLAB PM3 and the host computer.
2. Check that the power supply is connected and the power LED on the programmer is on.
3. Make sure you are not using a third party communications driver. Open your SYSTEM.INI file and look for the line in the [OPTIONS] section that reads:
COMM.DRV=COMM.DRV

If this line reads differently you are using a different communications driver.

B.5.1.2 SERIAL COMMUNICATIONS

1. Windows COM port setup requires special attention. If you suspect a driver-hardware incompatibility, try changing Flow Control to Hardware and/or turning off the FIFO for the serial port. This is done in the Control Panel.

In Windows 98/ME, click the System Icon. Click the **Device Manager** tab, and click **Ports**. If necessary, expand the Ports selection by clicking the '+' sign next to it. Double click the I/O port to which the programmer is connected. This is where you can set flow control to Hardware. To turn off FIFO, click the **Advanced** button, deselect the Use FIFO box and click **OK**. Reboot the PC to implement the change.

In Windows NT, click the **Ports** Icon. Select the COM port, click **Settings** and then click the **Advanced** button. Deselect the FIFO box, and click **OK**. Reboot the PC to implement the change.

In Windows 2000/XP, click the System Icon. Click the **Hardware** tab, and click the **Device Manager** button. If necessary, expand the Ports selection by clicking the '+' sign next to it. Double click the I/O port to which the programmer is connected. This is where you can set flow control to Hardware. To turn off FIFO, click the **Port Settings** tab, and click the **Advanced** button. Deselect the Use FIFO box, and click **OK**. Reboot the PC to implement the change.

2. Make sure that a COM port is properly set up exclusively for use by the programmer. Check the resources to ensure they are operating properly and that there are no conflicts with other devices. This commonly happens when you have another device that is improperly configured. Consult your Windows manual or other reference literature. You can try removing, reconfiguring or disabling the conflicting device, but do so only if you are familiar with those procedures.
3. Some system errors are caused by driver and hardware incompatibility.
4. Try connecting the programmer to a different serial port. If your PC has a 25-pin serial port, you will need a 25-to-9 serial port adapter.
5. Check that the device is plugged into the demo board/target application correctly; e.g., all pins are plugged into the socket and the device is correctly oriented.

For more information, see **Section B.5.2 “Advanced Serial Communications Help”**.

B.5.1.3 USB COMMUNICATIONS

1. Make sure you used the MPLAB IDE supplied USB driver for MPLAB ICD 2.

CAUTION

If the Windows OS picked a USB driver, MPLAB ICD 2 will not work and you will not be able to install the proper driver.

2. Make sure USB is selected on the *Programmer>Settings Communications* tab.

B.5.2 Advanced Serial Communications Help

Here are some areas that can cause problems:

- Modem Interaction
- Problems with a Serial Mouse
- Interrupt Conflicts
- Third Party Communications Drivers
- Manually Setting Up The Port

B.5.2.1 MODEM INTERACTION

The programmers cannot be on the same communications port or the same interrupt as a modem. You can try disabling the modem in software, moving one or the other to a different communications port or removing the modem.

B.5.2.2 PROBLEMS WITH A SERIAL MOUSE

If you have a serial mouse, make sure you are not accidentally specifying that communications port as your programmer port.

B.5.2.3 INTERRUPT CONFLICTS

Make sure that your system has no interrupt conflicts. That is, make sure that only one device is using each interrupt.

On Windows 98/ME, select *Settings>Control Panel* from the Start menu. Select **System** and click on the **Device Manager** tab. Expand the Ports selection and make sure there are no conflict indicators.

On Windows NT/2000/XP, select *Settings>Control Panel* from the Start menu. Select **System** and double click on **Ports**. Click on a COM port from the list and then click **Settings**. In the Settings dialog, click **Advanced**. Make sure there are no IRQ conflicts.

B.5.2.4 THIRD PARTY COMMUNICATIONS DRIVERS

The programmers are designed to run with the drivers shipped with the Windows operating system. Third party drivers may or may not work. Check your `SYSTEM.INI` file. Under [OPTIONS] you should have a line that reads:

```
COMM.DRV=COMM.DRV
```

If this line reads differently, you are using a third party driver.

B.5.2.5 MANUALLY SETTING UP THE PORT

On some systems, the programmer is unable to set up the communications port. It must be set up manually.

On Windows 98/ME, select *Settings>Control Panel* from the Start menu. Select **System** and click on the **Device Manager** tab. Expand the Ports selection and double click on the port you are trying to use. Click the **Port Settings** tab, and select 57600 baud, 8 data bits, no parity, 1 stop bit and hardware flow control. Click **Advanced**. Uncheck the "Use FIFO buffers" checkbox. Some systems have a problem with this. Reboot the PC to implement the change.

On Windows NT, select *Settings>Control Panel* from the Start menu. Select **System** and double click on Ports. Click on a COM port from the list and then click **Settings**. In the Settings dialog, select 57600 baud, 8 data bits, no parity, 1 stop bit and hardware flow control. Click **Advanced** and uncheck the "Use FIFO buffers" checkbox. Reboot the PC to implement the change.

On Windows 2000/XP, click the **System** Icon. Click the **Hardware** tab, and click the **Device Manager** button. If necessary, expand the Ports selection by clicking the '+' sign next to it. Double click the I/O port to which the programmer is connected. This is where you can set flow control to Hardware. To turn off FIFO, click the **Port Settings** tab, and click the **Advanced** button. Uncheck the "Use FIFO buffers" checkbox, and click **OK**. Reboot the PC to implement the change.

B.5.3 MPLAB PM3 Card Option Not Available on Programmer Menu

In order for the MPLAB PM3 Card options to be available on the MPLAB IDE Programmer menu, the MPLAB PM3 Card must be inserted in the MPLAB PM3 Programmer, the programmer must be powered on and the programmer must be enabled through MPLAB IDE. If the card is not supported, the MPLAB PM3 Card will not appear on the Programmer menu. (See the *Readme for MPLAB PM3* for a list of recommended cards.)

B.6 ERROR MESSAGES – PC

These are some error messages you may receive:

- Could Not Open the Communications Port
- USB Communication Could Not Be Established
- Device is Code-Protected
- Parity Error Found in Program Memory
- Program Memory Contains Code-Protected Data
- Invalid Checksum

B.6.1 Could Not Open the Communications Port

If the communications port cannot be opened, it is either because another application has opened the port, or the port does not exist. Make sure the port number is valid and that no other application is using it, such as another instance of MPLAB IDE.

B.6.2 USB Communication Could Not Be Established

If, while MPLAB PM3 is enabled using USB, the MPLAB PM3 unit is powered off and on quickly or power is temporarily interrupted, to reestablish USB communications, you must:

- Make sure the MPLAB PM3 power switch is off.
- Deselect MPLAB PM3 as the current programmer (*Programmer>Select Programmer>None*).
- Turn the MPLAB PM3 power back on.
- Reselect MPLAB PM3 as the programmer (*Programmer>Select Programmer>MPLAB PM3*).
- Enable the MPLAB PM3 programmer (*Programmer>Enable Programmer*). Wait 10 seconds for Windows to recognize it. If it doesn't work, restart the PC or try connecting to a different USB root hub.

B.6.3 Device is Code-Protected

If you attempt to read a code-protected device, you will get this warning. Obtain the original hex code from a file or a non-protected device. Also see **Section B.6.5 “Program Memory Contains Code-Protected Data”**.

B.6.4 Parity Error Found in Program Memory

Several devices have a Configuration bit to request the calculation of parity. When the bit is set to “ON,” the contents of the program memory are compared and assigned “even” or “odd” parity. When set to “OFF,” the device does not perform a comparison.

On a blank device, the parity Configuration bit is set to “ON” by default. If the device is programmed with the parity Configuration bit set to “ON,” any reprogramming of the device may result in a parity error being displayed. This occurs because a mismatch has been detected between the current parity and the parity last programmed.

Receiving a parity error, however, does not stop the device from being programmed.

However, if the device is programmed with the parity bit set to “OFF,” no comparison of the program memory contents for parity will take place. The device can be reprogrammed without receiving a message regarding parity.

All OTP devices, including those that have the parity Configuration bit, cannot successfully reprogram any bit value of ‘0’ to a ‘1’. If a device has been programmed with the parity Configuration bit set to “OFF,” the parity checking cannot be turned back to “ON.” A blank device will have to be used.

B.6.5 Program Memory Contains Code-Protected Data

Program memory contains data that was read from a code-protected device. Most or all of this data is not usable. Obtain the original hex code from a file or a non-protected device. See also **Section B.6.3 “Device is Code-Protected”**.

B.6.6 Invalid Checksum

This error indicates a hardware problem occurred while trying to read from the programmer. It is not a very common error. It usually indicates some sort of problem with the communication hardware on either the PC or the programmer.

B.7 ERROR MESSAGES – LCD

B.7.1 BIOS Errors

TABLE B-1: MPLAB® PM3 BEEP CODES

Number of Beeps	Meaning	Corrective Action
1	Normal start up	No action required.
2	CPLD Not Configured	Reset and connect to MPLAB IDE.
3	Power Monitor Not Found	Reset and connect to MPLAB IDE.
4	Display Not Found	Reset the unit. If the problem persists, contact your field representative to SAR the unit.
5	Display Read Write Test Failure	Reset the unit. If the problem persists, contact your field representative to SAR the unit.
6	FPGA Time-out	Reset the unit. If the problem persists, contact your field representative to SAR the unit.

TABLE B-2: BIOS ERROR CODES

Error Code	Definition	Corrective Action
1	CPLD is Not Configured	Reset and connect to MPLAB [®] IDE.
2	CPLD is Old	Reset and connect to MPLAB IDE.
3	Flash is Missing	Reset the unit. If the problem persists, contact your field representative to SAR the unit.
4	Flash is Crossed Incorrectly	Reset the unit. If the problem persists, contact your field representative to SAR the unit.
5	FPGA Configuration has Time-out	Reset and connect to MPLAB IDE.
6	FPGA Image is Missing	Reset and connect to MPLAB IDE.
7	FPGA is Old	Reset and connect to MPLAB IDE.
8	Power Monitor is Not Found	Reset and connect to MPLAB IDE.
9	Power Monitor is Old	Reset and connect to MPLAB IDE.
10	ICSP [™] Monitor is Not Found	Reset and connect to MPLAB IDE.
11	ICSP Monitor is Old	Reset and connect to MPLAB IDE.
12	Failure on the Daughter Board	Reset the unit. If the problem persists, contact your field representative to SAR the unit
13	USB is Not Found	Reset and connect to MPLAB IDE.
14	USB is Old	Reset and connect to MPLAB IDE.
15	Display was Not Found	Reset the unit. If the problem persists, contact your field representative to SAR the unit
16	Memory Failure	Reset the unit. If the problem persists, contact your field representative to SAR the unit
17	OS is Not Found	Reset and connect to MPLAB IDE.
18	VDD is Over Current	If programming using a socket module, verify that the proper part is selected and the part is inserted in the socket properly.
19	VPP is Over Current	If programming using a socket module, verify that the proper part is selected and the part is inserted in the socket properly.
20	OS is Old	Reset and connect to MPLAB IDE.
24	Clock is Missing	Reset the unit. If the problem persists, contact your field representative to SAR the unit
25	Display Read Write Failure	Reset the unit. If the problem persists, contact your field representative to SAR the unit
26	Power Monitor Can Not Ramp Up Voltages	Ensure the target is disconnected from MPLAB PM3 and retry. If it passes, check the ICSP wiring. If it fails again, contact your field representative to SAR the unit.
27	Updating Failed	Turn unit off. Check connections to PC. Make sure the appropriate port is selected and the proper drivers are installed. Restart and retry.

B.7.2 Additional Error Messages

- Hardware needs to be reconfigured. Please attach to PC and connect through MPLAB IDE to update [error number] – BIOS needs to download a newer version of some firmware.
- Fatal Error: Hardware not found. Contact your local field office for assistance [error number] – Cannot read a piece of hardware.
- Fatal Error: Memory Failure. Contact your local field office for assistance. [error number] – Memory test failed.

B.7.3 LCD Version Screen

On system boot-up, the version screen is displayed.

```
Bios Version..... [ver]
OS Version..... [ver]
Supervisor Version..... [ver]
Memory Controller Version..... [ver]
HS Shifter Version..... [ver]
Daughter Board Version..... [ver]
USB EEPROM Version..... [ver]
Database Version..... [ver]
    No Calibration Required!
```

B.8 LIMITATIONS

B.8.1 General Limitations

- View the “Readme for MPLAB PM3.txt” file for a list of currently supported devices.
- Program memory ranges that are not code-protected may only be changed from a ‘1’ to a ‘0’. Most devices need to be erased before they can be reprogrammed. DataEE does not need to be erased before it is programmed; however, it is programmed one location at a time. For more information, consult the specific programming specification for your device.
- Some devices program multiple locations at once. MPLAB PM3 therefore inhibits programming ranges not aligned to these bounds. See individual programming specifications for more information.

B.8.2 Device-Specific Limitations

In addition to the general limitations listed above, some PICmicro MCUs may have device-specific limitations. Select the device family limitations listed below, or search for your device in the index.

B.8.2.1 MPLAB PM3 LIMITATIONS FOR PIC18C601/801

- Your own memory read/write routines must be used for these ROMless devices.

B.8.2.2 MPLAB PM3 LIMITATIONS FOR ALL DEVICES

- For ICSP you must connect the AVDD and AVSS pins in addition to the VDD and VSS pins for the device to program.

Glossary

Absolute Section

A section with a fixed (absolute) address that cannot be changed by the linker.

Access Memory (PIC18 Only)

Special registers on PIC18XXXXX devices that allow access regardless of the setting of the Bank Select Register (BSR).

Address

Value that identifies a location in memory.

Alphabetic Character

Alphabetic characters are those characters that are letters of the arabic alphabet (a, b, ..., z, A, B, ..., Z).

Alphanumeric

Alphanumeric characters are comprised of alphabetic characters and decimal digits (0, 1, ..., 9).

ANSI

American National Standards Institute is an organization responsible for formulating and approving standards in the United States.

Application

A set of software and hardware that may be controlled by a PICmicro microcontroller.

Archive

A collection of relocatable object modules. It is created by assembling multiple source files to object files, then using the archiver to combine the object files into one library file. A library can be linked with object modules and other libraries to create executable code.

Archiver

A tool that creates and manipulates libraries.

ASCII

American Standard Code for Information Interchange is a character set encoding that uses 7 binary digits to represent each character. It includes upper and lower case letters, digits, symbols and control characters.

Assembler

A language tool that translates assembly language source code into machine code.

Assembly Language

A programming language that describes binary machine code in a symbolic form.

Asynchronous Stimulus

Data generated to simulate external inputs to a simulator device.

Breakpoint, Hardware

An event whose execution will cause a halt.

Breakpoint, Software

An address where execution of the firmware will halt. Usually achieved by a special break instruction.

Build

Compile and link all the source files for an application.

C

A general purpose programming language which features economy of expression, modern control flow and data structures and a rich set of operators.

Calibration Memory

A Special Function Register or registers used to hold values for calibration of a PICmicro microcontroller on-board RC oscillator or other device peripherals.

COFF

Common Object File Format. An object file of this format contains machine code, debugging and other information.

Command Line Interface

A means of communication between a program and its user based solely on textual input and output.

Compiler

A program that translates a source file written in a high-level language into machine code.

Configuration Bits

Special-purpose bits programmed to set PICmicro microcontroller modes of operation. A Configuration bit may or may not be preprogrammed.

Control Directives

Directives in assembly language code that cause code to be included or omitted based on the assembly-time value of a specified expression.

Cross Reference File

A file that references a table of symbols and a list of files that references the symbol. If the symbol is defined, the first file listed is the location of the definition. The remaining files contain references to the symbol.

Data Directives

Data directives are those that control the assembler's allocation of program or data memory and provide a way to refer to data items symbolically; that is, by meaningful names.

Data Memory

On Microchip MCU and DSC devices, data memory (RAM) is comprised of General Purpose Registers (GPRs) and Special Function Registers (SFRs). Some devices also have EEPROM data memory.

Device Programmer

A tool used to program electrically programmable semiconductor devices such as microcontrollers.

Directives

Statements in source code that provide control of the language tool's operation.

Download

Download is the process of sending data from a host to another device, such as an emulator, programmer or target board.

EEPROM

Electrically Erasable Programmable Read Only Memory. A special type of PROM that can be erased electrically. Data is written or erased one byte at a time. EEPROM retains its contents even when power is turned off.

Emulation

The process of executing software loaded into emulation memory as if it were firmware residing on a microcontroller device.

Emulation Memory

Program memory contained within the emulator.

Emulator

Hardware that performs emulation.

Emulator System

The MPLAB ICE 2000 and MPLAB ICE 4000 emulator systems include the pod, processor module, device adapter, cables and MPLAB IDE software.

Environment

A snapshot of the current programming settings. It contains all the necessary information to recreate the current programming state including links to the device's memory file, optional SQTP file and specific part information.

EPROM

Erasable Programmable Read Only Memory. A programmable read-only memory that can be erased usually by exposure to ultraviolet radiation.

Event

A description of a bus cycle which may include address, data, pass count, external input, cycle type (fetch, R/W) and time stamp. Events are used to describe triggers, breakpoints and interrupts.

Export

Send data out of MPLAB IDE in a standardized format.

Extended Microcontroller Mode

In Extended Microcontroller mode, on-chip program memory as well as external memory is available. Execution automatically switches to external if the program memory address is greater than the internal memory space of the PIC17CXXX or PIC18CXXX device.

External Label

A label that has external linkage.

External Linkage

A function or variable has external linkage if it can be referenced from outside the module in which it is defined.

External Symbol

A symbol for an identifier which has external linkage. This may be a reference or a definition.

External Symbol Resolution

A process performed by the linker in which external symbol definitions from all input modules are collected in an attempt to resolve all external symbol references. Any external symbol references which do not have a corresponding definition cause a linker error to be reported.

External Input Line

An external input signal logic probe line (TRIGIN) for setting an event based upon external signals.

External RAM

Off-chip Read/Write memory.

File Registers

On-chip data memory, including General Purpose Registers (GPRs) and Special Function Registers (SFRs).

Flash

A type of EEPROM where data is written or erased in blocks instead of bytes.

FNOP

Forced No Operation. A forced NOP cycle is the second cycle of a two-cycle instruction. Since the PICmicro microcontroller architecture is pipelined, it prefetches the next instruction in the physical address space while it is executing the current instruction. However, if the current instruction changes the program counter, this prefetched instruction is explicitly ignored, causing a forced NOP cycle.

GPR

General Purpose Register. The portion of device data memory (RAM) available for general use.

Halt

A stop of program execution. Executing Halt is the same as stopping at a breakpoint.

HEX Code

Executable instructions stored in a hexadecimal format code. HEX code is contained in a HEX file.

HEX File

An ASCII file containing hexadecimal addresses and values (HEX code) suitable for programming a device.

High-Level Language

A language for writing programs that is further removed from the processor than assembly.

ICD

In-Circuit Debugger. MPLAB ICD and MPLAB ICD 2 are Microchip's in-circuit debuggers for PIC16F87X and PIC18FXXX devices, respectively. These ICDs work with MPLAB IDE.

ICE

In-Circuit Emulator. MPLAB ICE 2000 and 4000 are Microchip's in-circuit emulators that work with MPLAB IDE.

IDE

Integrated Development Environment. MPLAB IDE is Microchip's integrated development environment.

Import

Bring data into MPLAB IDE from an outside source, such as from a HEX file.

Instruction Set

The collection of machine language instructions that a particular processor understands.

Instructions

A sequence of bits that tells a central processing unit to perform a particular operation and can contain data to be used in the operation.

Internal Linkage

A function or variable has internal linkage if it can not be accessed from outside the module in which it is defined.

International Organization for Standardization

An organization that sets standards in many businesses and technologies, including computing and communications.

Interrupt

A signal to the CPU that suspends the execution of a running application and transfers control to an Interrupt Service Routine (ISR) so that the event may be processed.

Interrupt Handler

A routine that processes special code when an interrupt occurs.

Interrupt Request

An event which causes the processor to temporarily suspend normal instruction execution and to start executing an interrupt handler routine. Some processors have several interrupt request events allowing different priority interrupts.

Interrupt Service Routine

User-generated code that is entered when an interrupt occurs. The location of the code in program memory will usually depend on the type of interrupt that has occurred.

IRQ

See Interrupt Request.

ISO

See International Organization for Standardization.

ISR

See Interrupt Service Routine.

Librarian

See Archiver.

Library

See Archive.

Linker

A language tool that combines object files and libraries to create executable code, resolving references from one module to another.

Linker Script Files

Linker script files are the command files of a linker. They define linker options and describe available memory on the target platform.

Listing Directives

Listing directives are those directives that control the assembler listing file format. They allow the specification of titles, pagination and other listing control.

Listing File

A listing file is an ASCII text file that shows the machine code generated for each C source statement, assembly instruction, assembler directive, or macro encountered in a source file.

Local Label

A local label is one that is defined inside a macro with the `LOCAL` directive. These labels are particular to a given instance of a macro's instantiation. In other words, the symbols and labels that are declared as local are no longer accessible after the ENDM macro is encountered.

Logic Probes

Up to 14 logic probes can be connected to some Microchip emulators. The logic probes provide external trace inputs, trigger output signal, +5V and a common ground.

Machine Code

The representation of a computer program that is actually read and interpreted by the processor. A program in binary machine code consists of a sequence of machine instructions (possibly interspersed with data). The collection of all possible instructions for a particular processor is known as its "instruction set".

Machine Language

A set of instructions for a specific central processing unit, designed to be usable by a processor without being translated.

Macro

Macroinstruction. An instruction that represents a sequence of instructions in abbreviated form.

Macro Directives

Directives that control the execution and data allocation within macro body definitions.

Make Project

A command that rebuilds an application, re-compiling only those source files that have changed since the last complete compilation.

MCU

Microcontroller Unit. An abbreviation for microcontroller. Also uC.

Message

Text displayed to alert you to potential problems in language tool operation. A message will not stop operation.

Microcontroller

A highly integrated chip that contains a CPU, RAM, program memory, I/O ports and timers.

Microcontroller Mode

One of the possible program memory configurations of the PIC17CXXX and PIC18CXXX families of microcontrollers. In Microcontroller mode, only internal execution is allowed. Thus, only the on-chip program memory is available in Microcontroller mode.

Microprocessor Mode

One of the possible program memory configurations of the PIC17CXXX and PIC18CXXX families of microcontrollers. In microprocessor mode, the on-chip program memory is not used. The entire program memory is mapped externally.

Mnemonics

Text instructions that can be translated directly into machine code. Also referred to as Opcodes.

MPASM Assembler

Microchip's relocatable macro assembler for PICmicro microcontroller devices, KEELOQ[®] devices and Microchip memory devices.

MPLAB ASM30

Microchip's relocatable macro assembler for dsPIC30F digital signal controller devices.

MPLAB C1X

Refers to both the MPLAB C17 and MPLAB C18 C compilers from Microchip. MPLAB C17 is the C compiler for PIC17CXXX devices and MPLAB C18 is the C compiler for PIC18CXXX and PIC18FXXXX devices.

MPLAB C30

Microchip's C compiler for dsPIC30F digital signal controller devices.

MPLAB ICD 2

Microchip's in-circuit debugger for PIC16F87X, PIC18FXXX and dsPIC30FXXXX devices. The ICD works with MPLAB IDE. The main component of each ICD is the module. A complete system consists of a module, header, demo board, cables and MPLAB IDE Software.

MPLAB ICE 2000

Microchip's in-circuit emulator for PICmicro MCU's that works with MPLAB IDE.

MPLAB ICE 4000

Microchip's in-circuit emulator for dsPIC DSC's that works with MPLAB IDE.

MPLAB IDE

Microchip's Integrated Development Environment.

MPLAB LIB30

MPLAB LIB30 archiver/librarian is an object librarian for use with COFF object modules created using either MPLAB ASM30 or MPLAB C30 C compiler.

MPLAB LINK30

MPLAB LINK30 is an object linker for the Microchip MPLAB ASM30 assembler and the Microchip MPLAB C30 C compiler.

MPLAB PM3

Microchip's production device programmer that works with MPLAB IDE in support of PICmicro MCU devices. It can be used with MPLAB IDE or as a stand-alone unit.

MPLAB SIM

Microchip's simulator that works with MPLAB IDE in support of PICmicro MCU devices.

MPLAB SIM30

Microchip's simulator that works with MPLAB IDE in support of dsPIC DSC devices.

MPLIB Object Librarian

MPLIB librarian is an object librarian for use with COFF object modules created using either MPASM assembler (mpasm or mpasmwin v2.0) or MPLAB C1X C compilers.

MPLINK Object Linker

MPLINK linker is an object linker for the Microchip MPASM assembler and the Microchip MPLAB C17 or C18 C compilers. MPLINK linker also may be used with the Microchip MPLIB librarian. MPLINK linker is designed to be used with MPLAB IDE, though it does not have to be.

MRU

Most Recently Used. Refers to files and windows available to be selected from MPLAB IDE main pull down menus.

Nesting Depth

The maximum level to which macros can include other macros.

Node

MPLAB IDE project component.

Non Real-Time

Refers to the processor at a breakpoint or executing single step instructions or MPLAB IDE being run in simulator mode.

Nonvolatile Storage

A storage device whose contents are preserved when its power is off.

NOP

No Operation. An instruction that has no effect when executed except to advance the program counter.

Object Code

The machine code generated by an assembler or compiler.

Object File

A file containing machine code and possibly debug information. It may be immediately executable or it may be relocatable, requiring linking with other object files, e.g. libraries, to produce a complete executable program.

Object File Directives

Directives that are used only when creating an object file.

Off-Chip Memory

Off-chip memory refers to the memory selection option for the PIC17CXXX or PIC18CXXX device where memory may reside on the target board, or where all program memory may be supplied by the Emulator. The **Memory** tab accessed from *Options>Development Mode* provides the Off-Chip Memory Selection dialog box.

Opcodes

Operational Codes. See Mnemonics.

Operators

Symbols, like the plus sign '+' and the minus sign '-', that are used when forming well-defined expressions. Each operator has an assigned precedence that is used to determine order of evaluation.

OTP

One Time Programmable. EPROM devices that are not in windowed packages. Since EPROM needs ultraviolet light to erase its memory, only windowed devices are erasable.

Pass Counter

A counter that decrements each time an event (such as the execution of an instruction at a particular address) occurs. When the pass count value reaches zero, the event is satisfied. You can assign the Pass Counter to break and trace logic, and to any sequential event in the complex trigger dialog.

PC

Personal Computer or Program Counter.

PC Host

Any IBM or compatible personal computer running a supported Windows operating system.

PICmicro MCUs

PICmicro microcontrollers (MCUs) refers to all Microchip microcontroller families.

PICSTART Plus

A developmental device programmer from Microchip. Programs 8-, 14-, 28- and 40-pin PICmicro microcontrollers. Must be used with MPLAB IDE Software.

Pod, Emulator

The external emulator box that contains emulation memory, trace memory, event and cycle timers and trace/breakpoint logic.

Power-on-Reset Emulation

A software randomization process that writes random values in data RAM areas to simulate uninitialized values in RAM upon initial power application.

PRO MATE II

A device programmer from Microchip. Programs all PICmicro microcontrollers and most memory and Keeloq devices. Can be used with MPLAB IDE or stand-alone.

Program Counter

The location that contains the address of the instruction that is currently executing.

Program Memory

The memory area in a device where instructions are stored. Also, the memory in the emulator or simulator containing the downloaded target application firmware.

Project

A set of source files and instructions to build the object and executable code for an application.

Prototype System

A term referring to a user's target application, or target board.

PWM Signals

Pulse Width Modulation Signals. Certain PICmicro MCU devices have a PWM peripheral.

Qualifier

An address or an address range used by the Pass Counter or as an event before another operation in a complex trigger.

Radix

The number base, HEX, or decimal, used in specifying an address.

RAM

Random Access Memory (Data Memory). Memory in which information can be accessed in any order.

Raw Data

The binary representation of code or data associated with a section.

Real-Time

When released from the halt state in the emulator or MPLAB ICD mode, the processor runs in Real-Time mode and behaves exactly as the normal chip would behave. In Real-Time mode, the real-time trace buffer of MPLAB ICE is enabled and constantly captures all selected cycles, and all break logic is enabled. In the emulator or MPLAB ICD, the processor executes in real-time until a valid breakpoint causes a halt, or until the user halts the emulator. In the simulator real-time simply means execution of the microcontroller instructions as fast as they can be simulated by the host CPU.

Recursion

The concept that a function or macro, having been defined, can call itself. Great care should be taken when writing recursive macros; it is easy to get caught in an infinite loop where there will be no exit from the recursion.

ROM

Read Only Memory (Program Memory). Memory that cannot be modified.

Run

The command that releases the emulator from halt, allowing it to run the application code and change or respond to I/O in real time.

Serialized Quick Turn Programming

Serialization allows you to program a serial number into each microcontroller device that the Device Programmer programs. This number can be used as an entry code, password or ID number.

SFR

See Special Function Registers.

Shell

The MPASM assembler shell is a prompted input interface to the macro assembler. There are two MPASM assembler shells: one for the DOS version and one for the Windows version.

Simulator

A software program that models the operation of devices.

Single Step

This command steps through code, one instruction at a time. After each instruction, MPLAB IDE updates register windows, watch variables and status displays so you can analyze and debug instruction execution. You can also single step C compiler source code, but instead of executing single instructions, MPLAB IDE will execute all assembly level instructions generated by the line of the high-level C statement.

Skew

The information associated with the execution of an instruction appears on the processor bus at different times. For example, the executed Opcodes appears on the bus as a fetch during the execution of the previous instruction, the source data address and value and the destination data address appear when the Opcodes is actually executed and the destination data value appears when the next instruction is executed. The trace buffer captures the information that is on the bus at one instance. Therefore, one trace buffer entry will contain execution information for three instructions. The number of captured cycles from one piece of information to another for a single instruction execution is referred to as the skew.

Skid

When a hardware breakpoint is used to halt the processor, one or more additional instructions may be executed before the processor halts. The number of extra instructions executed after the intended breakpoint is referred to as the skid.

Source Code

The form in which a computer program is written by the programmer. Source code is written in some formal programming language which can be translated into or machine code or executed by an interpreter.

Source File

An ASCII text file containing source code.

Special Function Registers

The portion of data memory (RAM) dedicated to registers that control I/O processor functions, I/O status, timers or other modes or peripherals.

SQTP

See Serialized Quick Turn Programming.

Stack, Hardware

Locations in PICmicro microcontroller where the return address is stored when a function call is made.

Stack, Software

Memory used by an application for storing return addresses, function parameters and local variables. This memory is typically managed by the compiler when developing code in a high-level language.

Static RAM or SRAM

Static Random Access Memory. Program memory you can Read/Write on the target board that does not need refreshing frequently.

Status Bar

The Status Bar is located on the bottom of the MPLAB IDE window and indicates such current information as cursor position, development mode and device and active tool bar.

Step Into

This command is the same as Single Step. Step Into (as opposed to Step Over) follows a `CALL` instruction into a subroutine.

Step Over

Step Over allows you to debug code without stepping into subroutines. When stepping over a `CALL` instruction, the next breakpoint will be set at the instruction after the `CALL`. If for some reason the subroutine gets into an endless loop or does not return properly, the next breakpoint will never be reached. The Step Over command is the same as Single Step except for its handling of `CALL` instructions.

Stimulus

Input to the simulator, i.e., data generated to exercise the response of simulation to external signals. Often the data is put into the form of a list of actions in a text file. Stimulus may be asynchronous, synchronous (pin), clocked and register.

Stopwatch

A counter for measuring execution cycles.

Symbol

A symbol is a general purpose mechanism for describing the various pieces which comprise a program. These pieces include function names, variable names, section names, file names, struct/enum/union tag names, etc. Symbols in MPLAB IDE refer mainly to variable names, function names and assembly labels. The value of a symbol after linking is its value in memory.

System Window Control

The system window control is located in the upper left corner of windows and some dialogs. Clicking on this control usually pops up a menu that has the items "Minimize," "Maximize" and "Close."

Target

Refers to user hardware.

Target Application

Software residing on the target board.

Target Board

The circuitry and programmable device that makes up the target application.

Target Processor

The microcontroller device on the target application board.

Template

Lines of text that you build for inserting into your files at a later time. The MPLAB Editor stores templates in template files.

Tool Bar

A row or column of icons that you can click on to execute MPLAB IDE functions.

Trace

An emulator or simulator function that logs program execution. The emulator logs program execution into its trace buffer which is uploaded to MPLAB IDE's trace window.

Trace Memory

Trace memory contained within the emulator. Trace memory is sometimes called the trace buffer.

Trigger Output

Trigger output refers to an emulator output signal that can be generated at any address or address range and is independent of the trace and breakpoint settings. Any number of trigger output points can be set.

Uninitialized Data

Data which is defined without an initial value. In C,

```
int myVar;
```

defines a variable which will reside in an uninitialized data section.

Upload

The Upload function transfers data from a tool, such as an emulator or programmer, to the host PC or from the target board to the emulator.

Warning

An alert that is provided to warn you of a situation that would cause physical damage to a device, software file, or equipment.

Watch Variable

A variable that you may monitor during a debugging session in a Watch window.

Watch Window

Watch windows contain a list of watch variables that are updated at each breakpoint.

Watchdog Timer

A timer on a PICmicro microcontroller that resets the processor after a selectable length of time. The WDT is enabled or disabled and set up using Configuration bits.

WDT

See Watchdog Timer.

MPLAB[®] PM3 User's Guide

NOTES:

Index

B		K	
Bin File	50	Keys	77
Binary File	50	L	
C		LCD	77
CE Compliance	8	Loading an Environment	52
Checksum	39	M	
Communications Cable		Memory Ranges	62
Installation	12	Microchip Internet Web Site	5
RS-232	13	MPASM Assembler	10
USB	13	MPLAB CXX	10
Configure Menu	56	MPLAB Development Tools	10
Creating an Environment	51	MPLAB Editor	10
Customer Notification Service	5	MPLAB ICE	10
Customer Support	6	MPLAB IDE	9, 37
D		Programmer Selection	17
Display	77	Starting	16
Documentation		MPLAB PM3	
Conventions	3	Back View	12, 87
Layout	2	Powering Down	16
E		Specifications	100
EEPROM/Flash	41	Top View	14
Enable MPLAB PM3	58	MPLAB PM3 Card	49
Enabling MPLAB PM3	20	MPLAB PM3 Components	8
Environment (PM3)	49, 50, 57, 87	MPLAB PM3 Programmer Menu	57
Environment File	50	MPLAB PM3 Socket Modules	14
Erase Flash Device	61	MPLAB Projects	10
F		MPLAB SIM	10
Files Used by MPLAB PM3	74	MPLIB Librarian	10
Function Keys	77	MPLINK Linker	10
H		N	
Hardware Installation	12	Num File	50
Hexadecimal Record	74	O	
I		Operation	
ICSP	44, 72	With a PC	9
ICSP Cable Installation	15	Without a PC	9, 45
ICSP Hardware Specifications	101		
Indicators			
Lights and Buzzer	16		
Installation			
Hardware	12		
ICSP Cable	15		
MPLAB PM3	11		
Software	11		
USB Driver	12		
Internet Address	5		

MPLAB® PM3 User's Guide

P

PICSTART Plus.....	10
PM3 File	50
Power Supply	
Installing.....	13
Powering Down	
MPLAB PM3	16
PRO MATE II Socket Modules.....	14
Program Memory	
Emulator.....	59
Simulator.....	59
Program Memory Window.....	58
Programmer Menu Items.....	57
Programming a Device.....	37, 46
Push Buttons	77

R

Reading a Device.....	43
Reading, Recommended.....	4
Readme.....	4
RS-232	12, 67

S

Saving an Environment	51
Selecting a Device	20
Selecting the Programmer.....	17, 58
Serial Communications Cable.....	13
Serial Port	13
Socket Cleaning Methods	106
Socket Life Expectancy	105
Socket Module	
Installing.....	14, 45
Software Installation.....	11
SQTP	7, 43
Stand-Alone Mode	9, 45
Starting MPLAB IDE.....	16
Starting MPLAB PM3	20

T

Transfer from MPLAB PM3	61
Transfer to MPLAB PM3	61
Troubleshooting	107

U

USB Driver Installation	12
-------------------------------	----

V

Verify	59
Voltages	63

W

Warranty Registration.....	4
Windowed Device.....	41
WWW Address	5

NOTES:



WORLDWIDE SALES AND SERVICE

AMERICAS

Corporate Office
2355 West Chandler Blvd.
Chandler, AZ 85224-6199
Tel: 480-792-7200
Fax: 480-792-7277
Technical Support:
<http://support.microchip.com>
Web Address:
www.microchip.com

Atlanta
Alpharetta, GA
Tel: 770-640-0034
Fax: 770-640-0307

Boston
Westborough, MA
Tel: 774-760-0087
Fax: 774-760-0088

Chicago
Itasca, IL
Tel: 630-285-0071
Fax: 630-285-0075

Dallas
Addison, TX
Tel: 972-818-7423
Fax: 972-818-2924

Detroit
Farmington Hills, MI
Tel: 248-538-2250
Fax: 248-538-2260

Kokomo
Kokomo, IN
Tel: 765-864-8360
Fax: 765-864-8387

Los Angeles
Mission Viejo, CA
Tel: 949-462-9523
Fax: 949-462-9608

San Jose
Mountain View, CA
Tel: 650-215-1444
Fax: 650-961-0286

Toronto
Mississauga, Ontario,
Canada
Tel: 905-673-0699
Fax: 905-673-6509

ASIA/PACIFIC

Australia - Sydney
Tel: 61-2-9868-6733
Fax: 61-2-9868-6755

China - Beijing
Tel: 86-10-8528-2100
Fax: 86-10-8528-2104

China - Chengdu
Tel: 86-28-8676-6200
Fax: 86-28-8676-6599

China - Fuzhou
Tel: 86-591-8750-3506
Fax: 86-591-8750-3521

China - Hong Kong SAR
Tel: 852-2401-1200
Fax: 852-2401-3431

China - Qingdao
Tel: 86-532-8502-7355
Fax: 86-532-8502-7205

China - Shanghai
Tel: 86-21-5407-5533
Fax: 86-21-5407-5066

China - Shenyang
Tel: 86-24-2334-2829
Fax: 86-24-2334-2393

China - Shenzhen
Tel: 86-755-8203-2660
Fax: 86-755-8203-1760

China - Shunde
Tel: 86-757-2839-5507
Fax: 86-757-2839-5571

China - Wuhan
Tel: 86-27-5980-5300
Fax: 86-27-5980-5118

China - Xian
Tel: 86-29-8833-7250
Fax: 86-29-8833-7256

ASIA/PACIFIC

India - Bangalore
Tel: 91-80-2229-0061
Fax: 91-80-2229-0062

India - New Delhi
Tel: 91-11-5160-8631
Fax: 91-11-5160-8632

India - Pune
Tel: 91-20-2566-1512
Fax: 91-20-2566-1513

Japan - Yokohama
Tel: 81-45-471- 6166
Fax: 81-45-471-6122

Korea - Gumi
Tel: 82-54-473-4301
Fax: 82-54-473-4302

Korea - Seoul
Tel: 82-2-554-7200
Fax: 82-2-558-5932 or
82-2-558-5934

Malaysia - Penang
Tel: 60-4-646-8870
Fax: 60-4-646-5086

Philippines - Manila
Tel: 63-2-634-9065
Fax: 63-2-634-9069

Singapore
Tel: 65-6334-8870
Fax: 65-6334-8850

Taiwan - Hsin Chu
Tel: 886-3-572-9526
Fax: 886-3-572-6459

Taiwan - Kaohsiung
Tel: 886-7-536-4818
Fax: 886-7-536-4803

Taiwan - Taipei
Tel: 886-2-2500-6610
Fax: 886-2-2508-0102

Thailand - Bangkok
Tel: 66-2-694-1351
Fax: 66-2-694-1350

EUROPE

Austria - Wels
Tel: 43-7242-2244-399
Fax: 43-7242-2244-393

Denmark - Copenhagen
Tel: 45-4450-2828
Fax: 45-4485-2829

France - Paris
Tel: 33-1-69-53-63-20
Fax: 33-1-69-30-90-79

Germany - Munich
Tel: 49-89-627-144-0
Fax: 49-89-627-144-44

Italy - Milan
Tel: 39-0331-742611
Fax: 39-0331-466781

Netherlands - Drunen
Tel: 31-416-690399
Fax: 31-416-690340

Spain - Madrid
Tel: 34-91-708-08-90
Fax: 34-91-708-08-91

UK - Wokingham
Tel: 44-118-921-5869
Fax: 44-118-921-5820

Mouser Electronics

Authorized Distributor

Click to View Pricing, Inventory, Delivery & Lifecycle Information:

[Microchip:](#)

[AC164350](#) [AC164342](#)