



# RF Power LDMOS Transistor

## N-Channel Enhancement-Mode Lateral MOSFET

This 87 W asymmetrical Doherty RF power LDMOS transistor is designed for cellular base station applications requiring very wide instantaneous bandwidth capability covering the frequency range of 2110 to 2200 MHz.

### 2100 MHz

- Typical Doherty Single-Carrier W-CDMA Performance:  $V_{DD} = 30$  Vdc,  $I_{DQA} = 400$  mA,  $V_{GSB} = 0.55$  Vdc,  $P_{out} = 87$  W Avg., Input Signal PAR = 9.9 dB @ 0.01% Probability on CCDF.

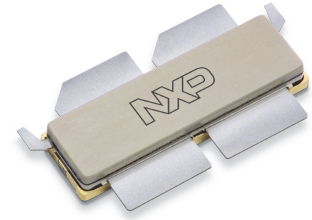
Frequency	$G_{ps}$ (dB)	$\eta_D$ (%)	Output PAR (dB)	ACPR (dBc)
2110 MHz	15.2	47.8	8.1	-31.4
2140 MHz	15.5	47.9	7.8	-31.2
2170 MHz	15.4	48.8	7.7	-30.7
2200 MHz	15.0	49.4	7.6	-30.8

### Features

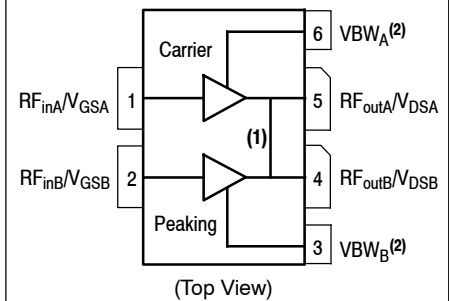
- Advanced high performance in-package Doherty
- Designed for wide instantaneous bandwidth applications
- Greater negative gate-source voltage range for improved Class C operation
- Able to withstand extremely high output VSWR and broadband operating conditions
- Designed for digital predistortion error correction systems

**A3T21H455W23SR6**

**2110–2200 MHz, 87 W AVG., 30 V  
 AIRFAST RF POWER LDMOS  
 TRANSISTOR**



ACP-1230S-4L2S



**Figure 1. Pin Connections**

1. Pin connections 4 and 5 are DC coupled and RF independent.
2. Device can operate with  $V_{DD}$  current supplied through pin 3 and pin 6.

**Table 1. Maximum Ratings**

Rating	Symbol	Value	Unit
Drain-Source Voltage	$V_{DSS}$	-0.5, +65	Vdc
Gate-Source Voltage	$V_{GS}$	-6.0, +10	Vdc
Operating Voltage	$V_{DD}$	32, +0	Vdc
Storage Temperature Range	$T_{stg}$	-65 to +150	°C
Case Operating Temperature Range	$T_C$	-40 to +150	°C
Operating Junction Temperature Range (1,2)	$T_J$	-40 to +225	°C
CW Operation @ $T_C = 25^\circ\text{C}$ when DC current is fed through pin 3 and pin 6 Derate above $25^\circ\text{C}$	CW	156 0.41	W W/°C

**Table 2. Thermal Characteristics**

Characteristic	Symbol	Value (2,3)	Unit
Thermal Resistance, Junction to Case Case Temperature $79^\circ\text{C}$ , 87 W Avg., W-CDMA, 30 Vdc, $I_{DQA} = 400\text{ mA}$ , $V_{GSB} = 0.55\text{ Vdc}$ , 2155 MHz	$R_{\theta JC}$	0.14	°C/W

**Table 3. ESD Protection Characteristics**

Test Methodology	Class
Human Body Model (per JS-001-2017)	2
Charge Device Model (per JS-002-2014)	C3

**Table 4. Electrical Characteristics** ( $T_A = 25^\circ\text{C}$  unless otherwise noted)

Characteristic	Symbol	Min	Typ	Max	Unit
----------------	--------	-----	-----	-----	------

**Off Characteristics (4)**

Zero Gate Voltage Drain Leakage Current ( $V_{DS} = 65\text{ Vdc}$ , $V_{GS} = 0\text{ Vdc}$ )	$I_{DSS}$	—	—	10	$\mu\text{Adc}$
Zero Gate Voltage Drain Leakage Current ( $V_{DS} = 32\text{ Vdc}$ , $V_{GS} = 0\text{ Vdc}$ )	$I_{DSS}$	—	—	5	$\mu\text{Adc}$
Gate-Source Leakage Current ( $V_{GS} = 5\text{ Vdc}$ , $V_{DS} = 0\text{ Vdc}$ )	$I_{GSS}$	—	—	1	$\mu\text{Adc}$

**On Characteristics - Side A, Carrier**

Gate Threshold Voltage ( $V_{DS} = 10\text{ Vdc}$ , $I_D = 160\ \mu\text{Adc}$ )	$V_{GS(th)}$	1.4	1.8	2.2	Vdc
Gate Quiescent Voltage ( $V_{DD} = 30\text{ Vdc}$ , $I_{DA} = 400\text{ mAdc}$ , Measured in Functional Test)	$V_{GSA(Q)}$	2.1	2.5	2.9	Vdc
Drain-Source On-Voltage ( $V_{GS} = 10\text{ Vdc}$ , $I_D = 1.6\text{ Adc}$ )	$V_{DS(on)}$	0.0	0.15	0.3	Vdc

**On Characteristics - Side B, Peaking**

Gate Threshold Voltage ( $V_{DS} = 10\text{ Vdc}$ , $I_D = 360\ \mu\text{Adc}$ )	$V_{GS(th)}$	0.8	1.2	1.6	Vdc
Drain-Source On-Voltage ( $V_{GS} = 10\text{ Vdc}$ , $I_D = 3.6\text{ Adc}$ )	$V_{DS(on)}$	0.0	0.15	0.3	Vdc

1. Continuous use at maximum temperature will affect MTTF.
2. MTTF calculator available at <http://www.nxp.com/RF/calculators>.
3. Refer to AN1955, *Thermal Measurement Methodology of RF Power Amplifiers*. Go to <http://www.nxp.com/RF> and search for AN1955.
4. Side A and Side B are tied together for these measurements.

(continued)

**Table 4. Electrical Characteristics** ( $T_A = 25^\circ\text{C}$  unless otherwise noted) (continued)

Characteristic	Symbol	Min	Typ	Max	Unit
<b>Functional Tests</b> <sup>(1,2,3)</sup> (In NXP Doherty Test Fixture, 50 ohm system) $V_{DD} = 30\text{ Vdc}$ , $I_{DQA} = 400\text{ mA}$ , $V_{GSB} = 0.55\text{ Vdc}$ , $P_{out} = 87\text{ W Avg.}$ , $f = 2200\text{ MHz}$ , Single-Carrier W-CDMA, IQ Magnitude Clipping, Input Signal PAR = 9.9 dB @ 0.01% Probability on CCDF. ACPR measured in 3.84 MHz Channel Bandwidth @ $\pm 5\text{ MHz}$ Offset.					
Power Gain	$G_{ps}$	13.8	15.0	16.8	dB
Drain Efficiency	$\eta_D$	46.0	49.4	—	%
$P_{out}$ @ 3 dB Compression Point, CW	P3dB	55.0	56.5	—	dBm
Adjacent Channel Power Ratio	ACPR	—	-30.8	-27.5	dBc

**Load Mismatch** <sup>(3)</sup> (In NXP Doherty Test Fixture, 50 ohm system)  $I_{DQA} = 400\text{ mA}$ ,  $V_{GSB} = 0.55\text{ Vdc}$ ,  $f = 2155\text{ MHz}$ , 12  $\mu\text{sec(on)}$ , 10% Duty Cycle

VSWR 10:1 at 32 Vdc, 295 W Pulsed CW Output Power (3 dB Input Overdrive from 158 W Pulsed CW Rated Power)	No Device Degradation
---	-----------------------

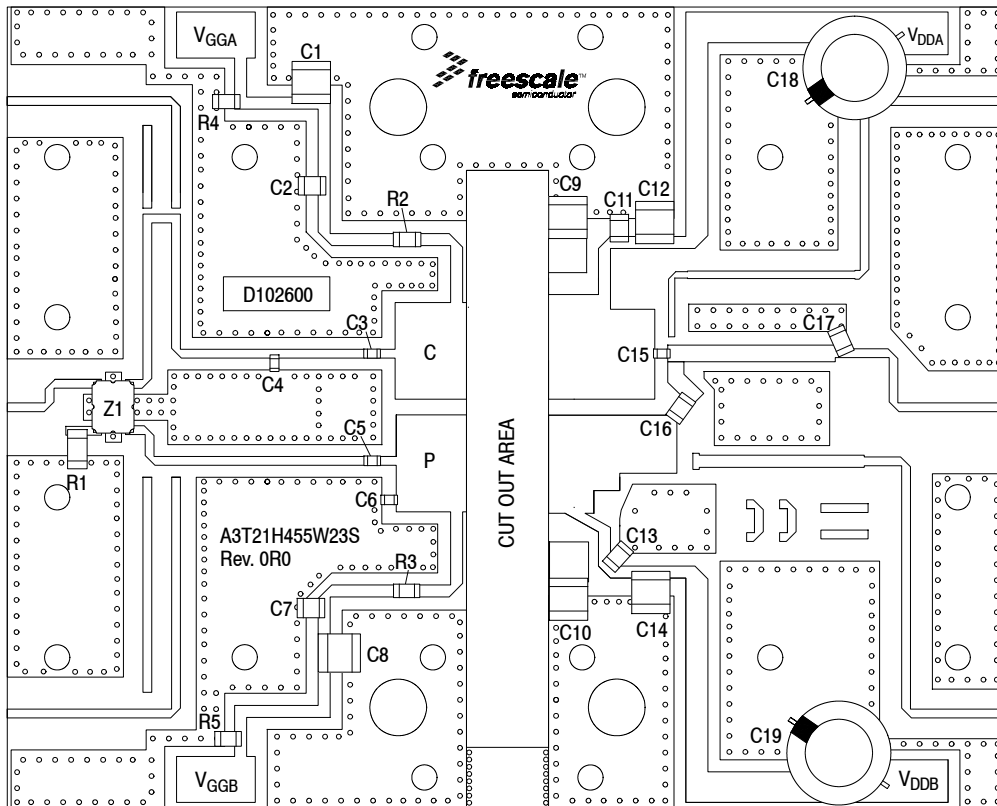
**Typical Performance** <sup>(3)</sup> (In NXP Doherty Test Fixture, 50 ohm system)  $V_{DD} = 30\text{ Vdc}$ ,  $I_{DQA} = 400\text{ mA}$ ,  $V_{GSB} = 0.55\text{ Vdc}$ , 2110–2200 MHz Bandwidth

$P_{out}$ @ 3 dB Compression Point <sup>(4)</sup>	P3dB	—	501	—	W
AM/PM (Maximum value measured at the P3dB compression point across the 2110–2200 MHz bandwidth)	$\Phi$	—	-20	—	$^\circ$
VBW Resonance Point (IMD Third Order Intermodulation Inflection Point)	$VBW_{res}$	—	180	—	MHz
Gain Flatness in 90 MHz Bandwidth @ $P_{out} = 87\text{ W Avg.}$	$G_F$	—	0.5	—	dB
Gain Variation over Temperature (-30°C to +85°C)	$\Delta G$	—	0.006	—	dB/°C
Output Power Variation over Temperature (-30°C to +85°C)	$\Delta P_{1dB}$	—	0.009	—	dB/°C

**Table 5. Ordering Information**

Device	Tape and Reel Information	Package
A3T21H455W23SR6	R6 Suffix = 150 Units, 56 mm Tape Width, 13-inch Reel	ACP-1230S-4L2S

- $V_{DDA}$  and  $V_{ddb}$  must be tied together and powered by a single DC power supply.
- Part internally matched both on input and output.
- Measurements made with device in an asymmetrical Doherty configuration.
- $P_{3dB} = P_{avg} + 7.0\text{ dB}$  where  $P_{avg}$  is the average output power measured using an unclipped W-CDMA single-carrier input signal where output PAR is compressed to 7.0 dB @ 0.01% probability on CCDF.



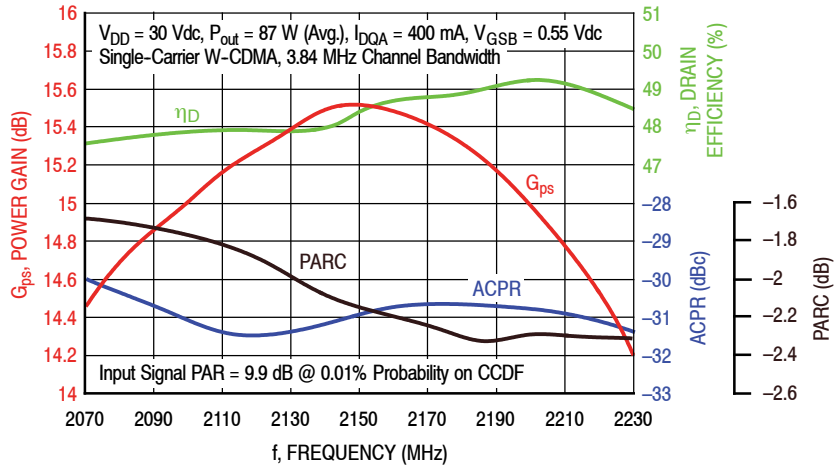
Note: V<sub>DDA</sub> and V<sub>ddb</sub> must be tied together and powered by a single DC power supply.

**Figure 2. A3T21H455W23SR6 Test Circuit Component Layout**

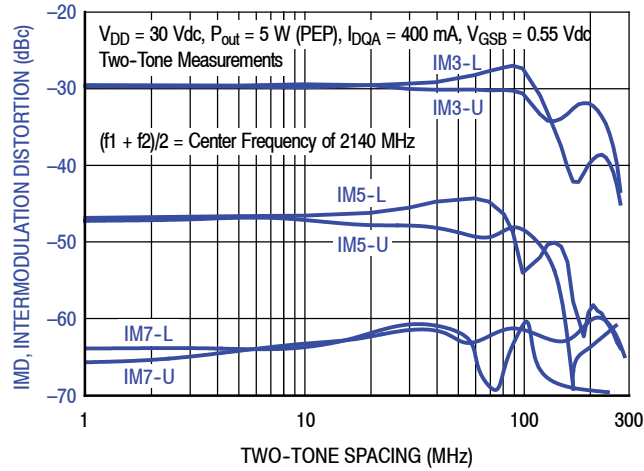
**Table 6. A3T21H455W23SR6 Test Circuit Component Designations and Values**

Part	Description	Part Number	Manufacturer
C1, C8, C9, C10, C12, C14	10 $\mu$ F Chip Capacitor	C5750X7S2A106M230KB	TDK
C2, C7, C11, C13	9.1 pF Chip Capacitor	ATC100B9R1CT500XT	ATC
C3, C5	9.1 pF Chip Capacitor	ATC600F9R1BT250XT	ATC
C4	1 pF Chip Capacitor	ATC600F1R0BT250XT	ATC
C6	0.4 pF Chip Capacitor	ATC600F0R4BT250XT	ATC
C15	5.1 pF Chip Capacitor	ATC600F5R1BT250XT	ATC
C16	15 pF Chip Capacitor	ATC100B150JT500XT	ATC
C17	0.2 pF Chip Capacitor	ATC100B0R2BT500XT	ATC
C18, C19	470 $\mu$ F, 63 V Electrolytic Capacitor	MCGPR63V477M13X26-RH	Multicomp
R1	50 $\Omega$ , 10 W Chip Resistor	C10A50Z4	Anaren
R2, R3	3.3 $\Omega$ , 1/4 W Chip Resistor	CRCW12063R30FKEA	Vishay
R4, R5	1.8 k $\Omega$ , 1/4 W Chip Resistor	CRCW12061K80FKEA	Vishay
Z1	2000–2300 MHz Band, 90°, 5 dB Directional Coupler	X3C21P1-05S	Anaren
PCB	Rogers RO4350B, 0.020", $\epsilon_r = 3.66$	D102600	MTL

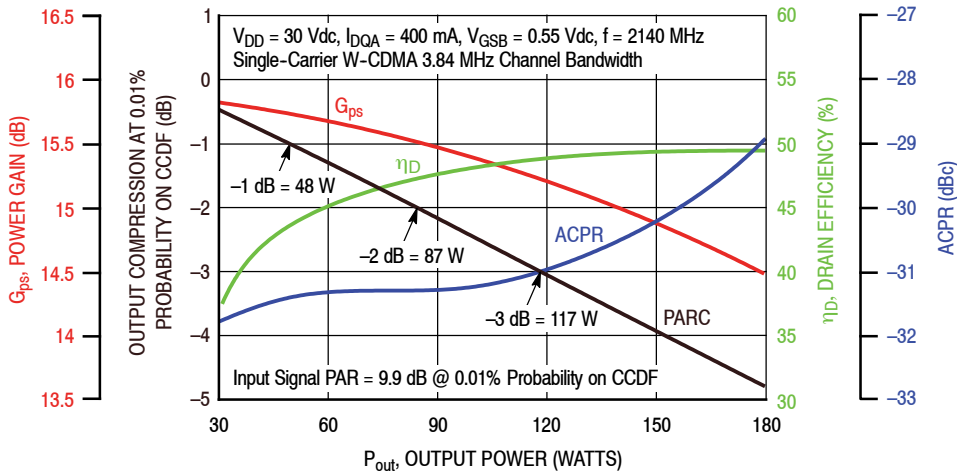
### TYPICAL CHARACTERISTICS — 2110–2200 MHz



**Figure 3. Single-Carrier Output Peak-to-Average Ratio Compression (PARC) Broadband Performance @  $P_{out} = 87$  Watts Avg.**

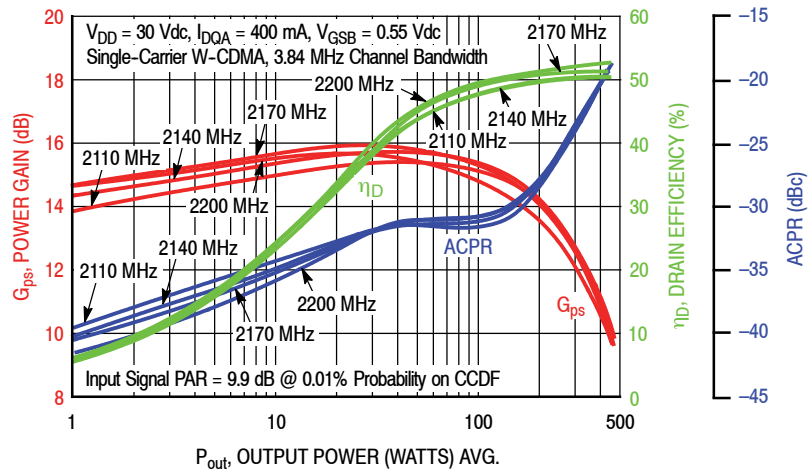


**Figure 4. Intermodulation Distortion Products versus Two-Tone Spacing**

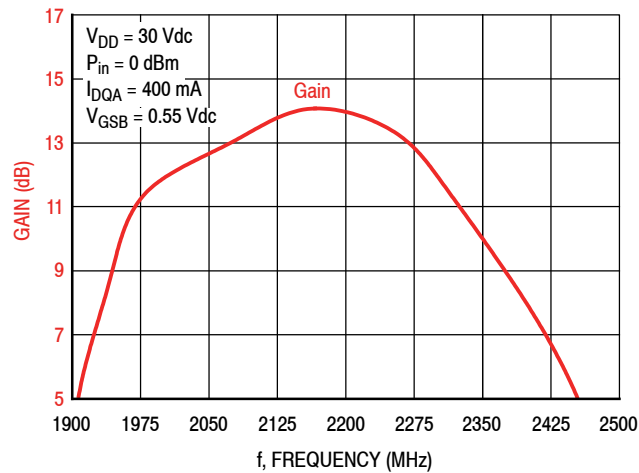


**Figure 5. Output Peak-to-Average Ratio Compression (PARC) versus Output Power**

## TYPICAL CHARACTERISTICS — 2110–2200 MHz



**Figure 6. Single-Carrier W-CDMA Power Gain, Drain Efficiency and ACPR versus Output Power**



**Figure 7. Broadband Frequency Response**

**Table 7. Carrier Side Load Pull Performance — Maximum Power Tuning**

$V_{DD} = 30$  Vdc,  $I_{DQA} = 778$  mA, Pulsed CW, 10  $\mu$ sec(on), 10% Duty Cycle

f (MHz)	$Z_{source}$ ( $\Omega$ )	$Z_{in}$ ( $\Omega$ )	Max Output Power					
			P1dB					
			$Z_{load}^{(1)}$ ( $\Omega$ )	Gain (dB)	(dBm)	(W)	$\eta_D$ (%)	AM/PM ( $^\circ$ )
2110	2.10 – j6.56	2.47 + j6.22	1.40 – j4.25	18.4	52.8	191	56.5	–13
2140	3.19 – j6.95	3.31 + j7.00	1.43 – j4.18	18.7	52.7	187	56.4	–12
2170	4.40 – j8.01	4.42 + j7.92	1.36 – j4.13	18.6	52.8	188	55.3	–12
2200	6.10 – j8.70	6.05 + j8.55	1.37 – j4.17	18.5	52.6	181	54.4	–13

f (MHz)	$Z_{source}$ ( $\Omega$ )	$Z_{in}$ ( $\Omega$ )	Max Output Power					
			P3dB					
			$Z_{load}^{(2)}$ ( $\Omega$ )	Gain (dB)	(dBm)	(W)	$\eta_D$ (%)	AM/PM ( $^\circ$ )
2110	2.10 – j6.56	2.38 + j6.55	1.35 – j4.45	16.1	53.6	228	57.3	–17
2140	3.19 – j6.95	3.23 + j7.45	1.37 – j4.29	16.4	53.5	223	57.4	–16
2170	4.40 – j8.01	4.43 + j8.55	1.35 – j4.27	16.4	53.5	225	56.5	–17
2200	6.10 – j8.70	6.28 + j9.33	1.35 – j4.38	16.2	53.3	216	54.4	–16

(1) Load impedance for optimum P1dB power.

(2) Load impedance for optimum P3dB power.

$Z_{source}$  = Measured impedance presented to the input of the device at the package reference plane.

$Z_{in}$  = Impedance as measured from gate contact to ground.

$Z_{load}$  = Measured impedance presented to the output of the device at the package reference plane.

**Table 8. Carrier Side Load Pull Performance — Maximum Efficiency Tuning**

$V_{DD} = 30$  Vdc,  $I_{DQA} = 778$  mA, Pulsed CW, 10  $\mu$ sec(on), 10% Duty Cycle

f (MHz)	$Z_{source}$ ( $\Omega$ )	$Z_{in}$ ( $\Omega$ )	Max Drain Efficiency					
			P1dB					
			$Z_{load}^{(1)}$ ( $\Omega$ )	Gain (dB)	(dBm)	(W)	$\eta_D$ (%)	AM/PM ( $^\circ$ )
2110	2.10 – j6.56	2.62 + j6.41	3.03 – j3.35	21.0	50.9	124	66.3	–18
2140	3.19 – j6.95	3.48 + j7.19	2.64 – j3.37	20.9	51.3	134	66.2	–16
2170	4.40 – j8.01	4.68 + j8.12	2.58 – j3.18	21.0	51.1	130	64.8	–17
2200	6.10 – j8.70	6.39 + j8.82	2.39 – j2.97	21.0	50.9	123	63.5	–18

f (MHz)	$Z_{source}$ ( $\Omega$ )	$Z_{in}$ ( $\Omega$ )	Max Drain Efficiency					
			P3dB					
			$Z_{load}^{(2)}$ ( $\Omega$ )	Gain (dB)	(dBm)	(W)	$\eta_D$ (%)	AM/PM ( $^\circ$ )
2110	2.10 – j6.56	2.53 + j6.61	3.05 – j3.96	18.6	51.9	156	65.1	–21
2140	3.19 – j6.95	3.40 + j7.49	2.63 – j3.97	18.4	52.3	169	65.5	–19
2170	4.40 – j8.01	4.72 + j8.53	2.78 – j3.74	18.6	52.0	160	64.0	–20
2200	6.10 – j8.70	6.48 + j9.33	2.38 – j3.72	18.2	52.3	172	63.5	–20

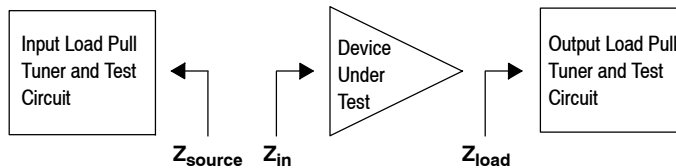
(1) Load impedance for optimum P1dB efficiency.

(2) Load impedance for optimum P3dB efficiency.

$Z_{source}$  = Measured impedance presented to the input of the device at the package reference plane.

$Z_{in}$  = Impedance as measured from gate contact to ground.

$Z_{load}$  = Measured impedance presented to the output of the device at the package reference plane.



**Table 9. Peaking Side Load Pull Performance — Maximum Power Tuning** $V_{DD} = 30$  Vdc,  $V_{GSB} = 1.9$  Vdc, Pulsed CW, 10  $\mu$ sec(on), 10% Duty Cycle

f (MHz)	$Z_{source}$ ( $\Omega$ )	$Z_{in}$ ( $\Omega$ )	Max Output Power					
			P1dB					
			$Z_{load}^{(1)}$ ( $\Omega$ )	Gain (dB)	(dBm)	(W)	$\eta_D$ (%)	AM/PM ( $^\circ$ )
2110	1.34 – j6.51	1.30 + j6.24	4.32 – j4.57	17.4	55.7	371	47.6	–16
2140	1.66 – j7.25	1.61 + j6.91	4.78 – j4.34	17.7	55.7	368	47.1	–16
2170	2.06 – j8.04	1.91 + j7.70	5.10 – j3.89	17.9	55.6	362	46.7	–17
2200	2.75 – j8.87	2.44 + j8.45	5.41 – j3.43	17.9	55.5	351	46.1	–18

f (MHz)	$Z_{source}$ ( $\Omega$ )	$Z_{in}$ ( $\Omega$ )	Max Output Power					
			P3dB					
			$Z_{load}^{(2)}$ ( $\Omega$ )	Gain (dB)	(dBm)	(W)	$\eta_D$ (%)	AM/PM ( $^\circ$ )
2110	1.34 – j6.51	1.32 + j6.49	5.03 – j4.92	15.2	56.2	419	46.6	–23
2140	1.66 – j7.25	1.65 + j7.24	5.44 – j4.46	15.5	56.2	415	46.5	–24
2170	2.06 – j8.04	1.99 + j8.11	5.78 – j3.82	15.8	56.1	409	46.1	–25
2200	2.75 – j8.87	2.61 + j8.93	6.22 – j2.94	15.9	56.0	397	45.7	–25

(1) Load impedance for optimum P1dB power.

(2) Load impedance for optimum P3dB power.

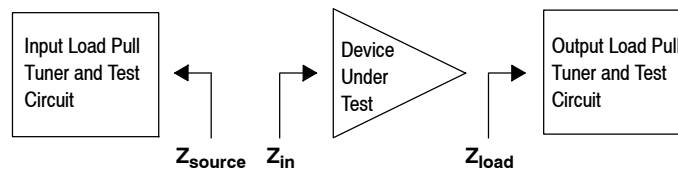
 $Z_{source}$  = Measured impedance presented to the input of the device at the package reference plane. $Z_{in}$  = Impedance as measured from gate contact to ground. $Z_{load}$  = Measured impedance presented to the output of the device at the package reference plane.**Table 10. Peaking Side Load Pull Performance — Maximum Efficiency Tuning** $V_{DD} = 30$  Vdc,  $V_{GSB} = 1.9$  Vdc, Pulsed CW, 10  $\mu$ sec(on), 10% Duty Cycle

f (MHz)	$Z_{source}$ ( $\Omega$ )	$Z_{in}$ ( $\Omega$ )	Max Drain Efficiency					
			P1dB					
			$Z_{load}^{(1)}$ ( $\Omega$ )	Gain (dB)	(dBm)	(W)	$\eta_D$ (%)	AM/PM ( $^\circ$ )
2110	1.34 – j6.51	1.15 + j6.20	4.09 – j1.99	19.1	54.9	308	53.4	–20
2140	1.66 – j7.25	1.42 + j6.86	4.11 – j1.85	19.3	55.0	314	53.1	–20
2170	2.06 – j8.04	1.66 + j7.62	3.65 – j1.61	19.7	54.8	305	52.4	–22
2200	2.75 – j8.87	2.15 + j8.38	3.63 – j1.45	19.5	54.8	301	51.9	–22

f (MHz)	$Z_{source}$ ( $\Omega$ )	$Z_{in}$ ( $\Omega$ )	Max Drain Efficiency					
			P3dB					
			$Z_{load}^{(2)}$ ( $\Omega$ )	Gain (dB)	(dBm)	(W)	$\eta_D$ (%)	AM/PM ( $^\circ$ )
2110	1.34 – j6.51	1.22 + j6.48	5.07 – j2.14	16.8	55.7	371	51.3	–26
2140	1.66 – j7.25	1.52 + j7.21	4.87 – j1.82	17.0	55.7	371	51.2	–27
2170	2.06 – j8.04	1.85 + j8.07	4.71 – j1.67	17.2	55.7	375	50.5	–28
2200	2.75 – j8.87	2.42 + j8.88	4.38 – j1.55	17.1	55.6	365	50.0	–29

(1) Load impedance for optimum P1dB efficiency.

(2) Load impedance for optimum P3dB efficiency.

 $Z_{source}$  = Measured impedance presented to the input of the device at the package reference plane. $Z_{in}$  = Impedance as measured from gate contact to ground. $Z_{load}$  = Measured impedance presented to the output of the device at the package reference plane.**A3T21H455W23SR6**



P1dB – TYPICAL CARRIER SIDE LOAD PULL CONTOURS — 2140 MHz

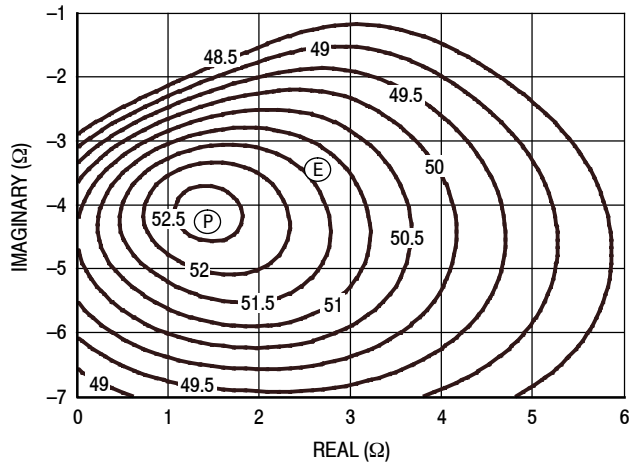


Figure 8. P1dB Load Pull Output Power Contours (dBm)

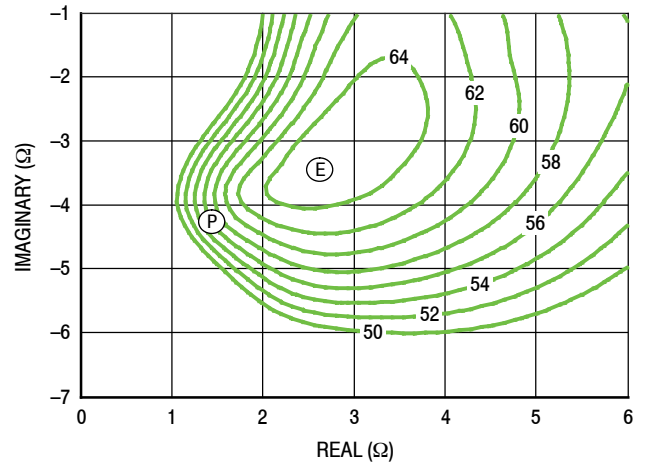


Figure 9. P1dB Load Pull Efficiency Contours (%)

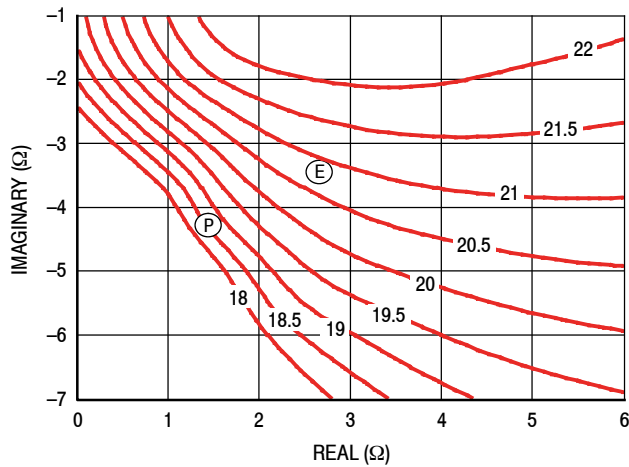


Figure 10. P1dB Load Pull Gain Contours (dB)

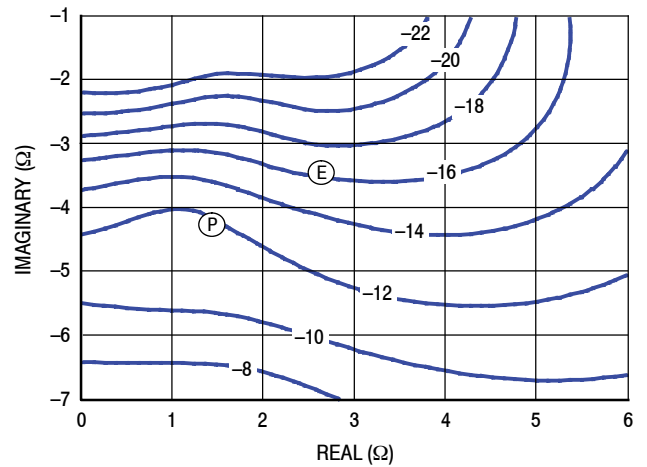


Figure 11. P1dB Load Pull AM/PM Contours (°)

**NOTE:** (P) = Maximum Output Power  
(E) = Maximum Drain Efficiency

- Gain
- Drain Efficiency
- Linearity
- Output Power

## P3dB – TYPICAL CARRIER SIDE LOAD PULL CONTOURS — 2140 MHz

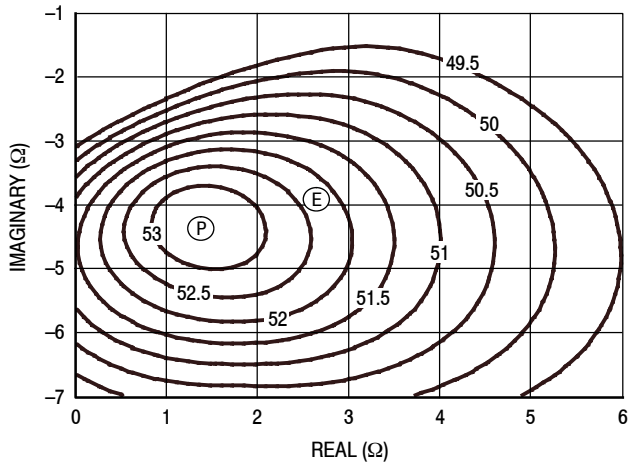


Figure 12. P3dB Load Pull Output Power Contours (dBm)

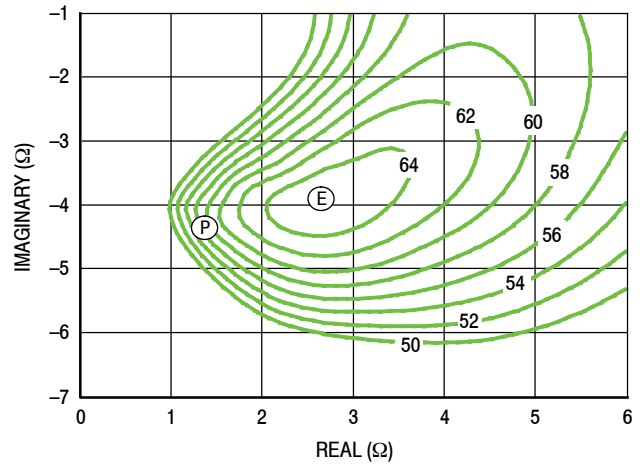


Figure 13. P3dB Load Pull Efficiency Contours (%)

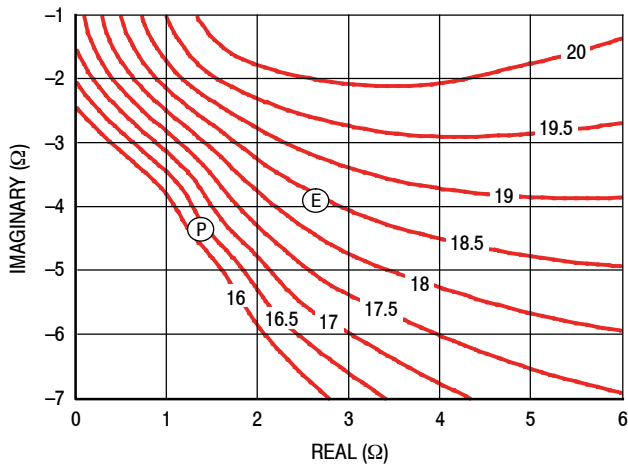


Figure 14. P3dB Load Pull Gain Contours (dB)

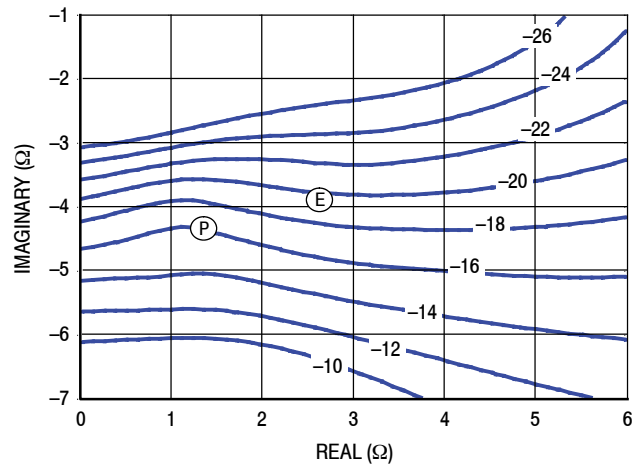
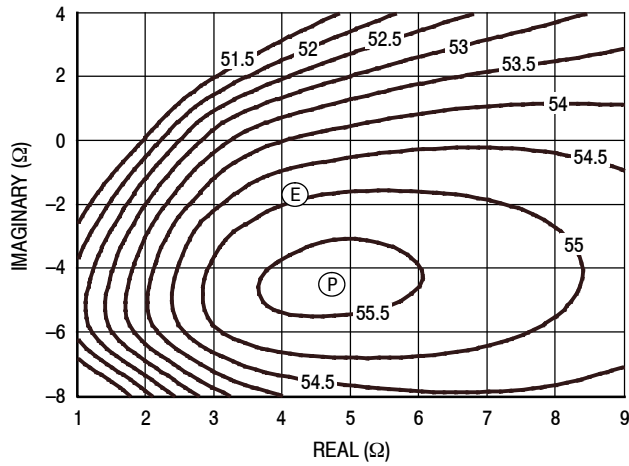


Figure 15. P3dB Load Pull AM/PM Contours (°)

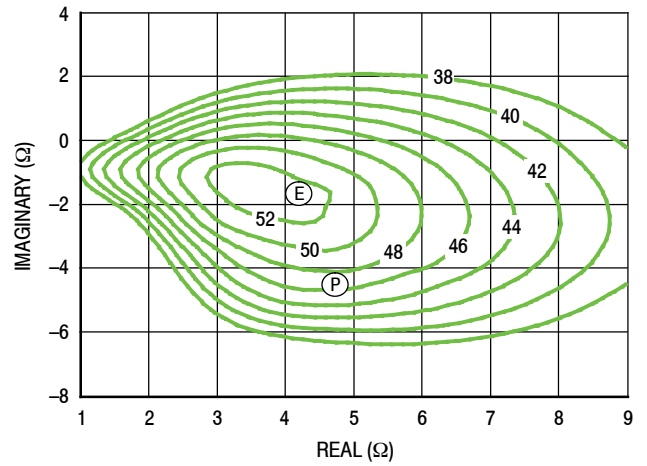
**NOTE:** (P) = Maximum Output Power  
 (E) = Maximum Drain Efficiency

- Gain
- Drain Efficiency
- Linearity
- Output Power

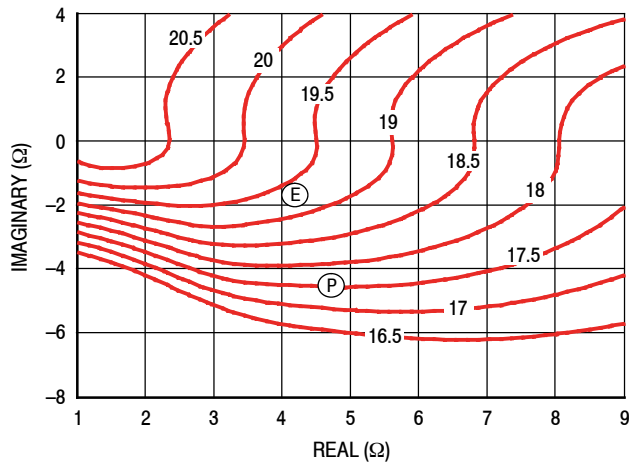
**P1dB – TYPICAL PEAKING SIDE LOAD PULL CONTOURS — 2140 MHz**



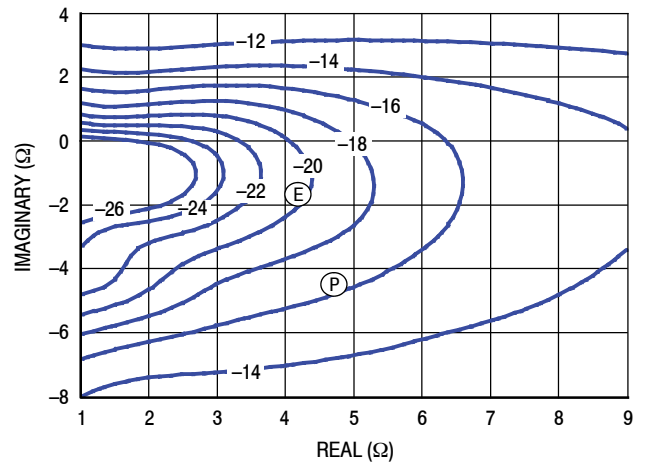
**Figure 16. P1dB Load Pull Output Power Contours (dBm)**



**Figure 17. P1dB Load Pull Efficiency Contours (%)**



**Figure 18. P1dB Load Pull Gain Contours (dB)**



**Figure 19. P1dB Load Pull AM/PM Contours (°)**

**NOTE:** (P) = Maximum Output Power  
(E) = Maximum Drain Efficiency

- Gain
- Drain Efficiency
- Linearity
- Output Power

## P3dB – TYPICAL PEAKING SIDE LOAD PULL CONTOURS — 2140 MHz

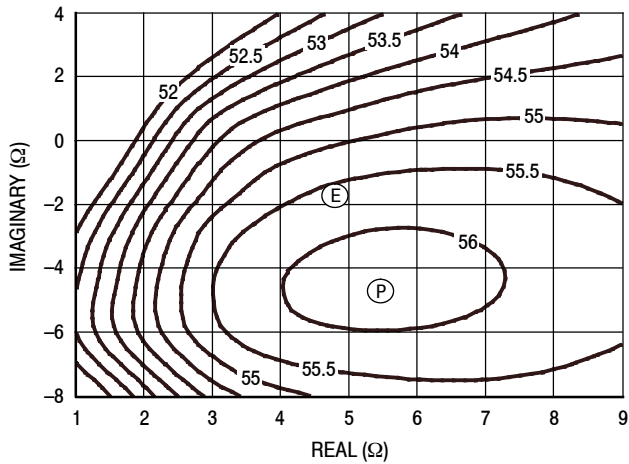


Figure 20. P3dB Load Pull Output Power Contours (dBm)

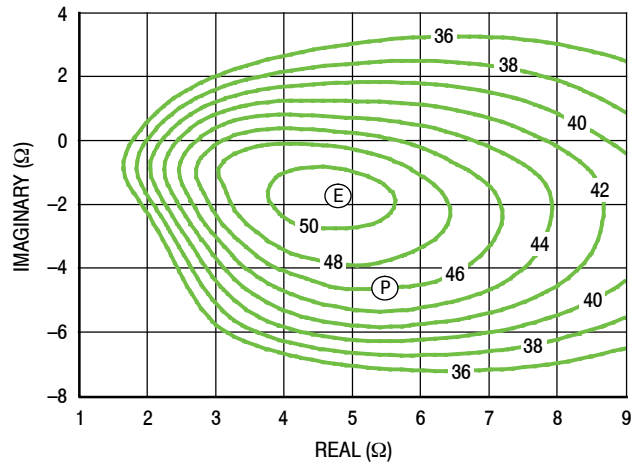


Figure 21. P3dB Load Pull Efficiency Contours (%)

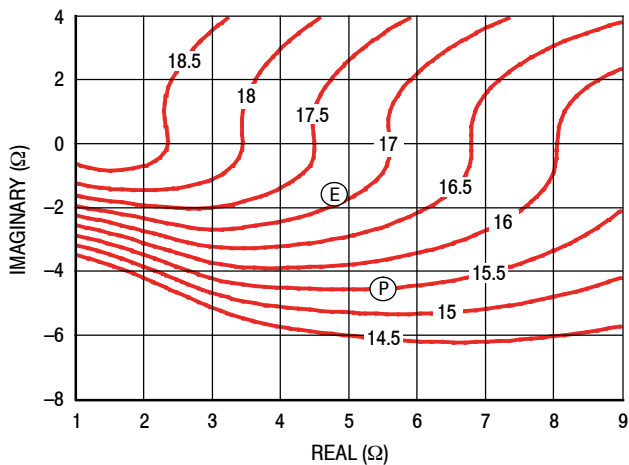


Figure 22. P3dB Load Pull Gain Contours (dB)

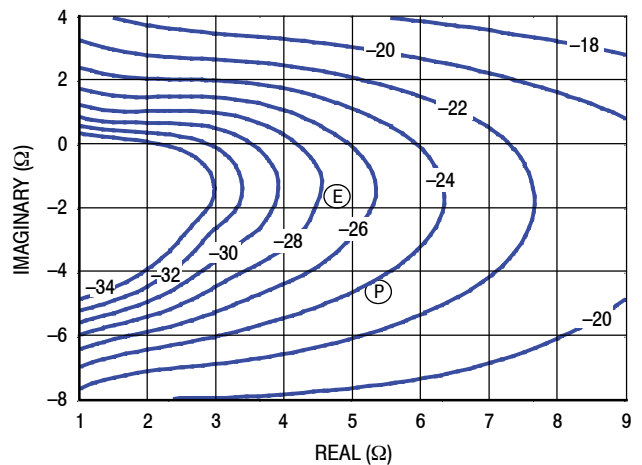


Figure 23. P3dB Load Pull AM/PM Contours (°)

**NOTE:** (P) = Maximum Output Power  
(E) = Maximum Drain Efficiency

- Gain
- Drain Efficiency
- Linearity
- Output Power

### PACKAGE DIMENSIONS



© NXP SEMICONDUCTORS N. V. ALL RIGHTS RESERVED	MECHANICAL OUTLINE	PRINT VERSION NOT TO SCALE
TITLE:  ACP-1230S-4L2S	DOCUMENT NO: 98ASA00974D	REV: A
	STANDARD: NON-JEDEC	
	SOT1800-4	21 JUN 2017

A3T21H455W23SR6

NOTES:

1. INTERPRET DIMENSIONS AND TOLERANCES PER ASME Y14.5M-1994.

2. CONTROLLING DIMENSION: INCH

3. DIMENSIONS H1 AND H2 ARE MEASURED .030 INCH (0.762 MM) AWAY FROM FLANGE PARALLEL TO DATUM B. H1 APPLIES TO PINS 1, 2, 4 & 5. H2 APPLIES TO PINS 3 & 6.

4. TOLERANCE OF DIMENSION H2 IS TENTATIVE.

5. THESE SURFACES OF THE HEAT SLUG ARE NOT PART OF THE SOLDERABLE SURFACES AND MAY REMAIN UNPLATED.

6. DATUM H IS LOCATED AT THE BOTTOM OF THE LEAD FRAME AND IS COINCIDENT WITH THE LEAD WHERE THE LEADS EXIT THE PLASTIC BODY.

7. DIMENSIONS M AND S DO NOT INCLUDE MOLD PROTRUSION. ALLOWABLE PROTRUSION IS .012 INCH (0.30 MM) PER SIDE. DIMENSIONS M AND S DO INCLUDE MOLD MISMATCH AND ARE DETERMINED AT DATUM PLANE H.

8. DIMENSIONS D, U AND K DO NOT INCLUDE DAMBAR PROTRUSION. ALLOWABLE DAMBAR PROTRUSION SHALL BE .010 INCH (0.25 MM) TOTAL IN EXCESS OF THE D, U AND K DIMENSION AT MAXIMUM MATERIAL CONDITION.

9. DATUM A AND B TO BE DETERMINED AT DATUM T.

DIM	INCHES		MILLIMETERS		DIM	INCHES		MILLIMETERS	
	MIN	MAX	MIN	MAX		MIN	MAX	MIN	MAX
AA	1.265	1.275	32.13	32.39	S	.365	.375	9.27	9.53
BB	.395	.405	10.03	10.29	U	.035	.045	0.89	1.14
CC	.160	.190	4.06	4.83	V1	.640	.655	16.26	16.64
D	.455	.465	11.56	11.81	W1	.105	.115	2.67	2.92
E	.062	.069	1.57	1.75	W2	.135	.145	3.43	3.68
F	.004	.007	0.10	0.18	W3	.245	.255	6.22	6.48
H1	.082	.090	2.08	2.29	W4	.265	.281	6.73	7.14
H2	.078	.094	1.98	2.39	Y	0.695 BSC		17.65 BSC	
K	.175	.195	4.45	4.95	Z1	R.000	R.040	R0.00	R1.02
L	0.270 BSC		6.86 BSC		Z2	.060	.100	1.52	2.54
M	1.219	1.241	30.96	31.52	aaa	.015		0.38	
N	1.218	1.242	30.94	31.55	bbb	.010		0.25	
R	.365	.375	9.27	9.53	ccc	.020		0.51	

© NXP SEMICONDUCTORS N.V.  
ALL RIGHTS RESERVED

MECHANICAL OUTLINE

PRINT VERSION NOT TO SCALE

TITLE:

ACP-1230S-4L2S

DOCUMENT NO: 98ASA00974D

REV: A

STANDARD: NON-JEDEC

SOT1800-4

21 JUN 2017

## PRODUCT DOCUMENTATION, SOFTWARE AND TOOLS

Refer to the following resources to aid your design process.

### Application Notes

- AN1908: Solder Reflow Attach Method for High Power RF Devices in Air Cavity Packages
- AN1955: Thermal Measurement Methodology of RF Power Amplifiers

### Engineering Bulletins

- EB212: Using Data Sheet Impedances for RF LDMOS Devices

### Software

- Electromigration MTTF Calculator
- .s2p File

### Development Tools

- Printed Circuit Boards

### To Download Resources Specific to a Given Part Number:

1. Go to <http://www.nxp.com/RF>
2. Search by part number
3. Click part number link
4. Choose the desired resource from the drop down menu

## REVISION HISTORY

The following table summarizes revisions to this document.

Revision	Date	Description
0	Mar. 2018	<ul style="list-style-type: none"><li>• Initial release of data sheet</li></ul>

## ***How to Reach Us:***

**Home Page:**  
nxp.com

**Web Support:**  
nxp.com/support

Information in this document is provided solely to enable system and software implementers to use NXP products. There are no express or implied copyright licenses granted hereunder to design or fabricate any integrated circuits based on the information in this document. NXP reserves the right to make changes without further notice to any products herein.

NXP makes no warranty, representation, or guarantee regarding the suitability of its products for any particular purpose, nor does NXP assume any liability arising out of the application or use of any product or circuit, and specifically disclaims any and all liability, including without limitation consequential or incidental damages. "Typical" parameters that may be provided in NXP data sheets and/or specifications can and do vary in different applications, and actual performance may vary over time. All operating parameters, including "typicals," must be validated for each customer application by customer's technical experts. NXP does not convey any license under its patent rights nor the rights of others. NXP sells products pursuant to standard terms and conditions of sale, which can be found at the following address: [nxp.com/SalesTermsandConditions](http://nxp.com/SalesTermsandConditions).

NXP, the NXP logo, Freescale, the Freescale logo, and Airfast are trademarks of NXP B.V. All other product or service names are the property of their respective owners.  
© 2018 NXP B.V.





# Mouser Electronics

Authorized Distributor

Click to View Pricing, Inventory, Delivery & Lifecycle Information:

[NXP:](#)

[A3T21H455W23SR6](#)